

**RIDERSERIES RCM
RCM570AE8**

Weidmüller Interface GmbH & Co. KG
Klingenbergstraße 26
D-32758 Detmold
Germany
Fon: +49 5231 14-0
Fax: +49 5231 14-292083
www.weidmueller.com

Product image

Similar to illustration

Standard relays in the RIDERSERIES RCM

- 4 CO contacts
- Relay with DC coil
- with test button
- With integrated status display and free-wheel diode

General ordering data

Type	RCM570AE8
Order No.	8957180000
Version	RIDERSERIES RCM, Relay, Number of contacts: 4 CO contact with test button AgNi 90/10, Rated control voltage: 48 V DC, Continuous current: 6 A, Plug-in connection
GTIN (EAN)	4032248755455
Qty.	10 pc(s).

Creation date May 1, 2020 4:13:13 AM CEST

Catalogue status 17.04.2020 / We reserve the right to make technical changes.

**RIDERSERIES RCM
RCM570AE8**

Weidmüller Interface GmbH & Co. KG
 Klingenbergstraße 26
 D-32758 Detmold
 Germany
 Fon: +49 5231 14-0
 Fax: +49 5231 14-292083
 www.weidmueller.com

Technical data**Dimensions and weights**

Width	22.5 mm	Width (inches)	0.886 inch
Height	28 mm	Height (inches)	1.102 inch
Depth	29 mm	Depth (inches)	1.142 inch
Net weight	30.5 g		

Temperatures

Humidity	40 °C / 93 % rel. humidity, no condensation	Operating temperature, max.	70 °C
Operating temperature, min.	-40 °C	Storage temperature, max.	85 °C
Storage temperature, min.	-40 °C	Operating temperature	-40 °C...70 °C
Storage temperature	-40 °C...85 °C		

Rated data UL

Certificate No. (cURus)	E224238
-------------------------	---------

Input

Rated control voltage	48 V DC	Rated current DC	15.6 mA
Power rating	750 mW	Pull-in/drop-out voltage, typ.	36 V / 4.8 V DC
Coil resistance	3072 Ω ± 10 %	Status indicator	Green LED
Protective circuit	Free-wheeling diode		

Output

Rated switching voltage	240 V AC	Max. switching voltage, AC	240 V
Continuous current	6 A	Inrush current	12 A / 20 ms
AC switching capacity (resistive), max.	1500 VA	DC switching capacity (resistive), max.	144 W @ 24 V
Switch-on delay	≤ 15 ms	Switch-off delay	< 20 ms
Min. switching power	1 mA @ 24 V, 10 mA @ 12 V, 100 mA @ 5 V	Max. switching frequency at rated load	0.1 Hz

Contact data

Contact type	Mechanical service life	AC coil 20 x 10 ⁶ switching cycles, DC coil 30 x 10 ⁶ switching cycles
4 CO contact with test button (AgNi 90/10)		

General data

Test button	yes (lockable)	Mechanical switch position indicator	Yes
Colour	Transparent	UL 94 flammability rating	V-2

Insulation coordination

Rated voltage	250 V	Surge voltage category	III
Pollution severity	2	Insulating material group	IIIa
Protection degree	IP20	Dielectric strength, Input/Output	2.5 kV _{eff} / 1 Min.
Creepage and clearance distance input – output	≥ 4 mm	Dielectric strength of neighbouring contacts	2 kV _{eff} / 1 min
Dielectric strength of open contact	1.2 kV _{eff} / 1 min.	Impulse withstand voltage	5 kV (1.2/50 μs)

Data sheet

RIDERSERIES RCM RCM570AE8

Weidmüller Interface GmbH & Co. KG
 Klingenbergstraße 26
 D-32758 Detmold
 Germany
 Fon: +49 5231 14-0
 Fax: +49 5231 14-292083
 www.weidmueller.com

Technical data

Further details of approvals / standards

Standards	IEC 61810-1	Certificate No. (CSA)	249409-2426937
Certificate No. (cURus)	E224238		

Connection data

Wire connection method	Plug-in connection
------------------------	--------------------

Classifications

ETIM 6.0	EC001437	ETIM 7.0	EC001437
eClass 9.0	27-37-16-01	eClass 9.1	27-37-16-01
eClass 10.0	27-37-16-01	UNSPSC	30-21-18-01

Approvals

Approvals



ROHS	Conform
------	---------

Downloads

Approval/Certificate/Document of Conformity	EU Konformitätserklärung / EU Declaration of Conformity
Brochure/Catalogue	CAT 4.2 ELECTR 18/19 EN
Engineering Data	EPLAN, WSCAD
Engineering Data	STEP

**RIDERSERIES RCM
RCM570AE8**

Weidmüller Interface GmbH & Co. KG
Klingenbergstraße 26
D-32758 Detmold
Germany
Fon: +49 5231 14-0
Fax: +49 5231 14-292083
www.weidmueller.com

Drawings

Wiring diagram

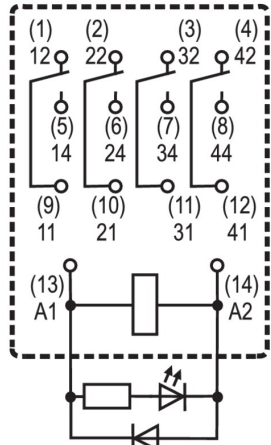

View of Pins from below

Graph

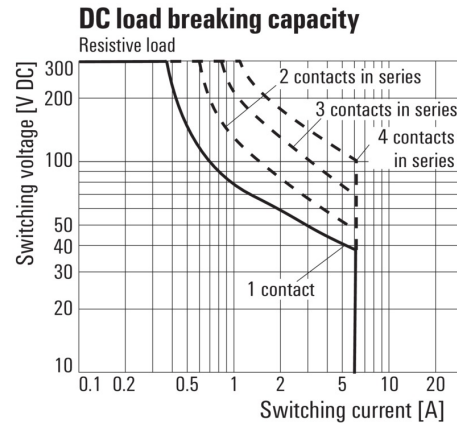

DC load limit curve
Resistive load

Graph

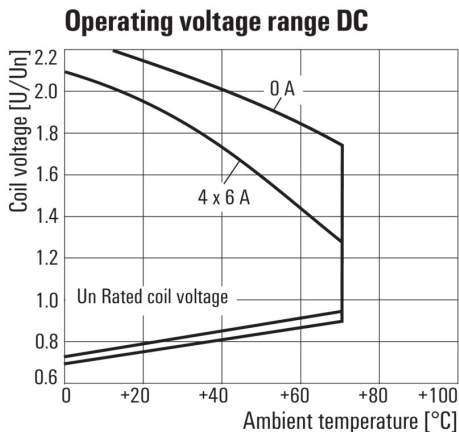

DC operational voltage range

Graph

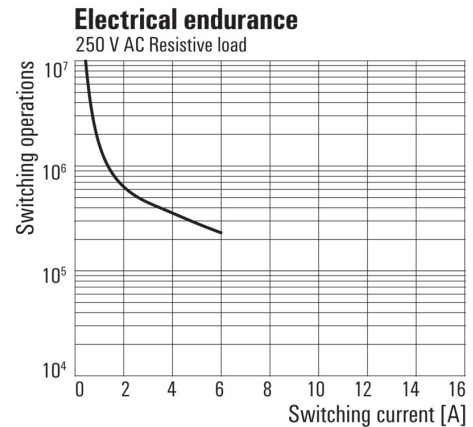

Electrical service life
250 V AC resistive load

Graph

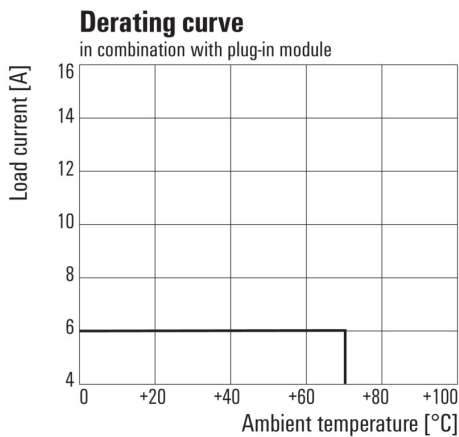

Derating curve
Relay in combination with base

Dimensional drawing



RIDERSERIES RCM RCM570AE8

Weidmüller Interface GmbH & Co. KG
 Klingenbergstraße 26
 D-32758 Detmold
 Germany
 Fon: +49 5231 14-0
 Fax: +49 5231 14-292083
 www.weidmueller.com

Mating connector (fully pluggable)

Base



Relay base for RIDERSERIES RCM relays

- 2, 3 and 4 CO contacts
- Screw and PUSH IN wire connection
- Standard and low heights

General ordering data

Type	SCM-I 4CO P	Version
Order No.	8869430000	RIDERSERIES RCM, Relay bases, Number of contacts: 4 CO contact,
GTIN (EAN)	4032248614288	Continuous current: 6 A, PUSH IN
Qty.	10 pc(s).	
Type	SCM-I 4CO N	Version
Order No.	8869390000	RIDERSERIES RCM, Relay bases, Number of contacts: 4 CO contact,
GTIN (EAN)	4032248614257	Continuous current: 6 A, Screw connection
Qty.	10 pc(s).	
Type	SCM-I 4CO	Version
Order No.	8869420000	RIDERSERIES RCM, Relay bases, Number of contacts: 4 CO contact,
GTIN (EAN)	4032248614271	Continuous current: 6 A, Screw connection
Qty.	10 pc(s).	

**RIDERSERIES RCM
RCM570AE8**

Weidmüller Interface GmbH & Co. KG
 Klingenbergstraße 26
 D-32758 Detmold
 Germany
 Fon: +49 5231 14-0
 Fax: +49 5231 14-292083
 www.weidmueller.com

Accessories

LED

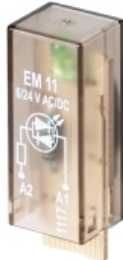

Pluggable protective modules for the RIDERSERIES RCI / RCM relay base, with optional protective functions.

- With either green or red LED
- For UC supply voltage

General ordering data

Type	RIM-I 3 24/60VUC	Version
Order No.	8869610000	RIDERSERIES, LED module, Rated control voltage: 24...60 V UC, Plug-
GTIN (EAN)	4032248614554	in connection
Qty.	10 pc(s).	

Type	RIM-I 3 24/60VUC GN	Version
Order No.	8869620000	RIDERSERIES, LED module, Rated control voltage: 24...60 V UC, Plug-
GTIN (EAN)	4032248614561	in connection
Qty.	10 pc(s).	

Plastic retaining clip



Plastic retaining clip for RIDERSERIES RCM relays

General ordering data

Type	SCM-I CLIP P	Version
Order No.	8869440000	RIDERSERIES RCM, Retaining clip
GTIN (EAN)	4032248614295	
Qty.	10 pc(s).	

Type	SCM-I CLIP N	Version
Order No.	8875620000	RIDERSERIES RCM, Retaining clip
GTIN (EAN)	4032248608577	
Qty.	10 pc(s).	

RIDERSERIES RCM RCM570AE8

Weidmüller Interface GmbH & Co. KG
 Klingenbergstraße 26
 D-32758 Detmold
 Germany
 Fon: +49 5231 14-0
 Fax: +49 5231 14-292083
 www.weidmueller.com

Accessories

Cross-connection for base with PUSH IN connection



Weidmüller RIDERSERIES relays guarantee a noise-free, decoupled signal transmission in industrial automation concepts.

The are compact, quickly installed and can be fitted in the tightest of spaces.

- 2, 3 or 4 CO contacts
- optionally: AC or DC coils
- Relay with test button and integrated status display and/or free-wheel diode
- Optionally with hard gold plated 4 CO contacts
- pluggable LED modules with protective functions
- Metal and plastic retaining clips
- Base with screw / PUSH IN connection

General ordering data

Type	SCM-I QV P	Version
Order No.	8870850000	RIDERSERIES RCM, Cross-connector
GTIN (EAN)	4032248631698	
Qty.	10 pc(s).	

LED / free-wheel diode



Pluggable protective modules for the RIDERSERIES RCI / RCM relay base, with optional protective functions.

- With either green or red LED
- With free-wheel diode
- For DC supply voltage

General ordering data

Type	RIM-I 2 24/60VDC	Version
Order No.	8869670000	RIDERSERIES, LED module with freewheel diode, Rated control
GTIN (EAN)	4032248614608	voltage: 24...60 V DC, Plug-in connection
Qty.	10 pc(s).	
Type	RIM-I 2 24/60VDC GN	Version
Order No.	8869680000	RIDERSERIES, LED module with freewheel diode, Rated control
GTIN (EAN)	4032248614615	voltage: 24...60 V DC, Plug-in connection
Qty.	10 pc(s).	

**RIDERSERIES RCM
RCM570AE8**

Weidmüller Interface GmbH & Co. KG
 Klingenbergstraße 26
 D-32758 Detmold
 Germany
 Fon: +49 5231 14-0
 Fax: +49 5231 14-292083
 www.weidmueller.com

Accessories
Cross-connection for base with screw connection

You place stringent demands on your relay combinations in industrial environments. Our D-SERIES relay modules were

designed specifically for challenging industrial applications.

Let's connect.

In many industrial applications voltages between 110 and 220 V

are used to control actuators. With load currents exceeding 100 mA

these high voltages produce arcing that causes a great deal of wear on the relay contacts.

We have designed our D-SERIES relay modules specifically for universal usage

in a wide range of industrial applications. They are much more reliable

than conventional solutions, which minimises costs for maintenance and replacement.

Thanks to series connected contacts, built-in blow magnets and low-wear

contacts, arcing is effectively

suppressed with D-SERIES products – resulting in a noticeably longer service life.

General ordering data

Type	SCM-I QV S	Version
Order No.	1132080000	RIDERSERIES RCM, Cross-connector
GTIN (EAN)	4032248912193	
Qty.	10 pc(s).	

Base

Relay base for RIDERSERIES RCM relays

- 2, 3 and 4 CO contacts
- Screw and PUSH IN wire connection
- Standard and low heights

General ordering data

Type	SCM-I 4CO P	Version
Order No.	8869430000	RIDERSERIES RCM, Relay bases, Number of contacts: 4 CO contact,
GTIN (EAN)	4032248614288	Continuous current: 6 A, PUSH IN
Qty.	10 pc(s).	

Data sheet

**RIDERSERIES RCM
RCM570AE8**

Weidmüller Interface GmbH & Co. KG
Klingenbergstraße 26
D-32758 Detmold
Germany
Fon: +49 5231 14-0
Fax: +49 5231 14-292083
www.weidmueller.com

Accessories

Type	SCM-I 4CO N	Version
Order No.	8869390000	RIDERSERIES RCM, Relay bases, Number of contacts: 4 CO contact,
GTIN (EAN)	4032248614257	Continuous current: 6 A, Screw connection
Qty.	10 pc(s).	

Type	SCM-I 4CO	Version
Order No.	8869420000	RIDERSERIES RCM, Relay bases, Number of contacts: 4 CO contact,
GTIN (EAN)	4032248614271	Continuous current: 6 A, Screw connection
Qty.	10 pc(s).	

Metal retaining clip

Metal retaining clip for RIDERSERIES RCM relays



General ordering data

Type	SCM-I CLIP M	Version
Order No.	8869450000	RIDERSERIES RCM, Retaining clip
GTIN (EAN)	4032248614301	
Qty.	10 pc(s).	

Protection module

Pluggable protective modules for the RIDERSERIES RCI / RCM relay base, with optional protective functions.

- Optionally with free-wheel diode, load resistor or RC filter



General ordering data

Type	RIM-I 1 6/230V	Version
Order No.	8869580000	RIDERSERIES, Free-wheeling diode, Rated control voltage: 6...230 V
GTIN (EAN)	4032248614523	DC, Plug-in connection
Qty.	10 pc(s).	

**RIDERSERIES RCM
RCM570AE8**

Weidmüller Interface GmbH & Co. KG
Klingenbergstraße 26
D-32758 Detmold
Germany
Fon: +49 5231 14-0
Fax: +49 5231 14-292083
www.weidmueller.com

Accessories**Label (cannot be printed using PrintJet)**

Weidmüller RIDERSERIES relays guarantee a noise-free, decoupled signal transmission in industrial automation concepts.

The are compact, quickly installed and can be fitted in the tightest of spaces.

- 2, 3 or 4 CO contacts
- optionally: AC or DC coils
- Relay with test button and integrated status display and/or free-wheel diode
- Optionally with hard gold plated 4 CO contacts
- pluggable LED modules with protective functions
- Metal and plastic retaining clips
- Base with screw / PUSH IN connection

General ordering data

Type	SCMH MARK	Version
Order No.	8869460000	RIDERSERIES RCM, Label
GTIN (EAN)	4032248614417	
Qty.	10 pc(s).	

**RIDERSERIES RCM
RCM570AE8**

Weidmüller Interface GmbH & Co. KG
 Klingenbergstraße 26
 D-32758 Detmold
 Germany
 Fon: +49 5231 14-0
 Fax: +49 5231 14-292083
 www.weidmueller.com

Drawings

Miscellaneous

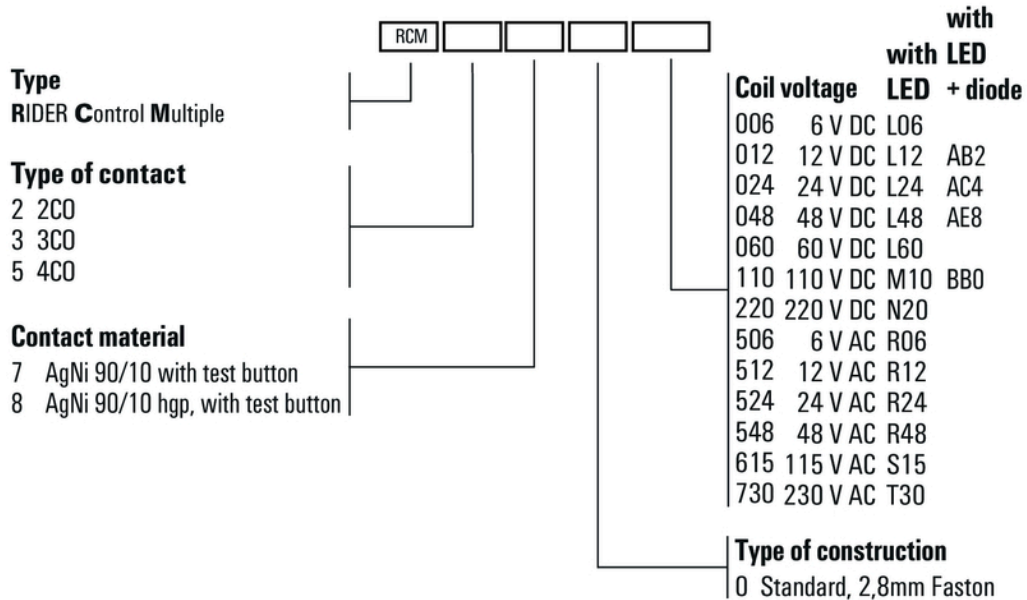

Type codes