

RIDERSERIES RCI RCIKIT 24VDC 1CO LD

Weidmüller Interface GmbH & Co. KG
 Klingenbergstraße 26
 D-32758 Detmold
 Germany
 Fon: +49 5231 14-0
 Fax: +49 5231 14-292083
 www.weidmueller.com

Product image

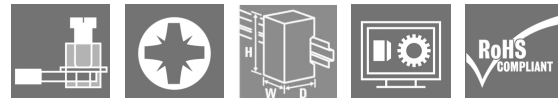

Modular system comprised of:

- relay socket for rail mounting
- LED indicator unit
- retaining clip
- plug-in relay
- markers

General ordering data

Type	RCIKIT 24VDC 1CO LD
Order No.	8871000000
Version	RIDERSERIES RCI, Relay module, Number of contacts: 1 CO contact AgNi 90/10, Rated control voltage: 24 V DC, Continuous current: 16 A ⁽¹⁾ , Screw connection
GTIN (EAN)	4032248604135
Qty.	10 pc(s).

Creation date May 1, 2020 5:48:09 AM CEST

Catalogue status 17.04.2020 / We reserve the right to make technical changes.

**RIDERSERIES RCI
RCIKIT 24VDC 1CO LD**

Weidmüller Interface GmbH & Co. KG
Klingenbergstraße 26
D-32758 Detmold
Germany
Fon: +49 5231 14-0
Fax: +49 5231 14-292083
www.weidmueller.com

Technical data
Dimensions and weights

Width	15.8 mm	Width (inches)	0.622 inch
Height	77 mm	Height (inches)	3.031 inch
Depth	70.2 mm	Depth (inches)	2.764 inch
Net weight	57.32 g		

Temperatures

Humidity	40 °C / 93 % rel. humidity, no condensation	Operating temperature, max.	70 °C
Operating temperature, min.	-40 °C	Storage temperature, max.	70 °C
Storage temperature, min.	-40 °C	Operating temperature	-40 °C...70 °C
Storage temperature	-40 °C...70 °C		

Environmental Product Compliance

REACH SVHC	Lead 7439-92-1
------------	----------------

Input

Rated control voltage	24 V DC	Rated current DC	16.7 mA
Power rating	420 mW	Pull-in/drop-out voltage, typ.	16.8 V / 2.4 V DC
Coil resistance	1440 Ω ± 10 %	Status indicator	Green LED
Protective circuit	Free-wheeling diode		

Output

Rated switching voltage	250 V AC	Max. switching voltage, AC	400 V
Continuous current	16 A ⁽¹⁾	Inrush current	30 A / 4 s
AC switching capacity (resistive), max.	4000 VA	DC switching capacity (resistive), max.	384 W @ 24 V
Switch-on delay	≤ 8 ms	Switch-off delay	≤ 6 ms
Min. switching power	1 mA @ 24 V, 10 mA @ 12 V, 100 mA @ 5 V	Max. switching frequency at rated load	0.1 Hz

Contact data

Contact type	1 CO contact (AgNi 90/10)	Mechanical service life	AC coil 5 x 10 ⁶ switching cycles, DC coil 10 x 10 ⁶ switching cycles
--------------	---------------------------	-------------------------	---

General data

Rail	TS 35	Test button	No
Mechanical switch position indicator	No	Colour	black

Insulation coordination

Rated voltage	250 V	Surge voltage category	III
Pollution severity	2	Insulating material group	IIIa
Protection degree	IP20	Dielectric strength, Input/Output	5 kV _{eff} / 1 min
Creepage and clearance distance input – output	≥ 8 mm	Dielectric strength of open contact	1 kV _{eff} / 1 min
Impulse withstand voltage	5 kV (1.2/50 μs)		

**RIDERSERIES RCI
RCIKIT 24VDC 1CO LD**

Weidmüller Interface GmbH & Co. KG
 Klingenbergstraße 26
 D-32758 Detmold
 Germany
 Fon: +49 5231 14-0
 Fax: +49 5231 14-292083
 www.weidmueller.com

Technical data**Further details of approvals / standards**

Standards	DIN EN 50178	Certificate no. (CSA) relay	249409-2426937
Certificate no. (CSA) base	249409-2295474	Certificate No. (DNVGL)	TAA000011A
Certificate no. (cURus) relay	E224238	Certificate no. (cURus) base	E223759

Connection data

Wire connection method	Screw connection	Stripping length, rated connection	8 mm
Tightening torque, min.	0.5 Nm	Tightening torque, max.	0.7 Nm
Clamping range, rated connection	2.5 mm ²	Clamping range, min.	1 mm ²
Clamping range, max.	2.5 mm ²	Wire cross-section, solid, min.	1 mm ²
Wire cross-section, solid, max.	2.5 mm ²	Wire connection cross-section, finely stranded, min.	1 mm ²
Wire connection cross section, finely stranded, max.	2.5 mm ²	Wire connection cross-section, finely stranded with wire-end ferrules DIN 46228/4, min.	1 mm ²
Wire connection cross-section, finely stranded with wire-end ferrules DIN 46228/4, max.	2.5 mm ²	Conductor cross-section, flexible, AEH (DIN 46228-1), min.	1 mm ²
Conductor cross-section, flexible, AEH (DIN 46228-1), max.	2.5 mm ²	Wire connection cross section, finely stranded, two clampable wires, min.	1 mm ²
Wire cross-section, finely stranded, two clampable wires, max.	1.5 mm ²	Blade size	size PZ1

Classifications

ETIM 6.0	EC001437	ETIM 7.0	EC001437
eClass 9.0	27-37-16-01	eClass 9.1	27-37-16-01
eClass 10.0	27-37-16-01	UNSPSC	30-21-19-17

Product information

Product information 1) For full continuous current (16 A), relay connections 11–21, 12–22 and 14–24 must be bridged. IP20 without connected conductor at complete opened clamping yoke connection.

Approvals

Approvals



ROHS Conform

Downloads

Approval/Certificate/Document of Conformity	EU Konformitätserklärung / EU Declaration of Conformity
Brochure/Catalogue	CAT 4.2 ELECTR 18/19 EN
Engineering Data	EPLAN, WSCAD, Zuken E3.S
Engineering Data	STEP

**RIDERSERIES RCI
RCIKIT 24VDC 1CO LD**

Weidmüller Interface GmbH & Co. KG
Klingenbergstraße 26
D-32758 Detmold
Germany
Fon: +49 5231 14-0
Fax: +49 5231 14-292083
www.weidmueller.com

Drawings

Wiring diagram

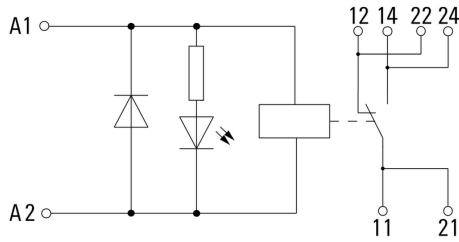

Graph

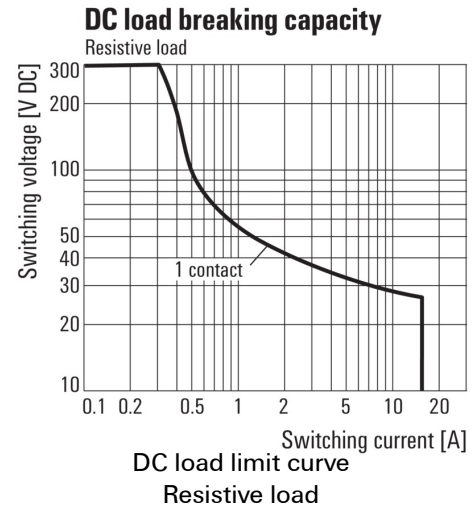

Graph

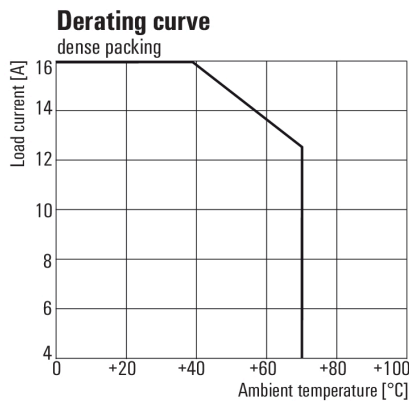

For full continuous current (16 A), socket connections 11-21, 12-22 and 14-24 must be bridged.

Derating curve
Relay in combination with base

Graph

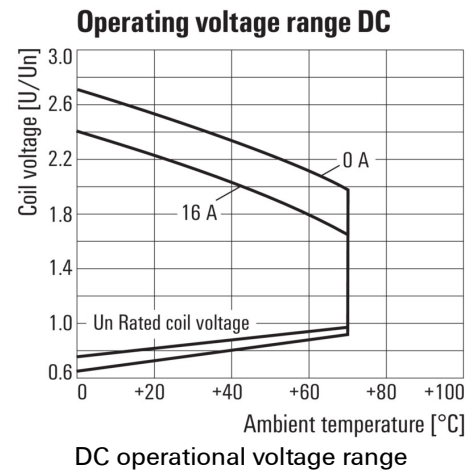

Graph

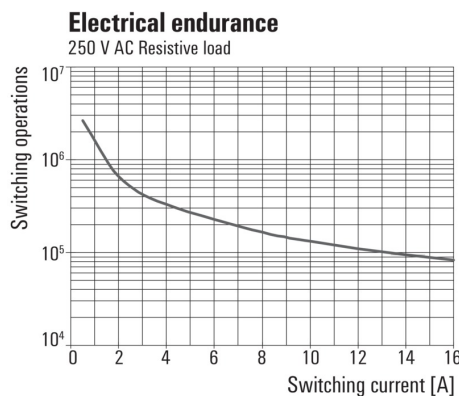

Electrical service life 250 V AC resistive load
250 V AC resistive load

Dimensioned drawing

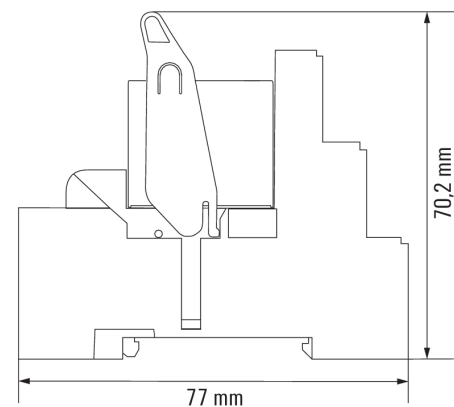

**RIDERSERIES RCI
RCIKIT 24VDC 1CO LD**

Weidmüller Interface GmbH & Co. KG
 Klingenbergstraße 26
 D-32758 Detmold
 Germany
 Fon: +49 5231 14-0
 Fax: +49 5231 14-292083
 www.weidmueller.com

Accessories

Label (cannot be printed using PrintJet)



Weidmüller RIDERSERIES relays guarantee a noise-free, decoupled signal transmission in industrial automation concepts. They are compact, quickly installed and can be fitted in the tightest of spaces.

- 1 or 2 CO contacts
- optionally: AC or DC coils
- Relay optionally with integrated status display and/or free-wheel diode and optionally combined with a test button
- pluggable LED modules with protective functions
- Metal and plastic retaining clips
- Base with screw / PUSH IN connection

General ordering data

Type	SRC-I MARK	Version
Order No.	8869530000	RIDERSERIES RCI, Label
GTIN (EAN)	4032248614479	
Qty.	10 pc(s).	

LED

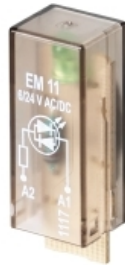

Pluggable protective modules for the RIDERSERIES RCI / RCM relay base, with optional protective functions.

- With either green or red LED
- For UC supply voltage

General ordering data

Type	RIM-I 3 6/24VUC	Version
Order No.	8869630000	RIDERSERIES, LED module, Rated control voltage: 6...24 V UC, Plug-in connection
GTIN (EAN)	4032248614578	
Qty.	10 pc(s).	
Type	RIM-I 3 24/60VUC	Version
Order No.	8869610000	RIDERSERIES, LED module, Rated control voltage: 24...60 V UC, Plug-in connection
GTIN (EAN)	4032248614554	
Qty.	10 pc(s).	
Type	RIM-I 3 6/24VUC GN	Version
Order No.	8869640000	RIDERSERIES, LED module, Rated control voltage: 6...24 V UC, Plug-in connection
GTIN (EAN)	4032248614585	
Qty.	10 pc(s).	
Type	RIM-I 3 24/60VUC GN	Version
Order No.	8869620000	RIDERSERIES, LED module, Rated control voltage: 24...60 V UC, Plug-in connection
GTIN (EAN)	4032248614561	
Qty.	10 pc(s).	

**RIDERSERIES RCI
RCIKIT 24VDC 1CO LD**

Weidmüller Interface GmbH & Co. KG
Klingenbergstraße 26
D-32758 Detmold
Germany
Fon: +49 5231 14-0
Fax: +49 5231 14-292083
www.weidmueller.com

Accessories

Crosshead screwdriver, Pozidrive



VDE insulated screwdriver sets, for working on live parts up to 1000 V AC and 1500 V DC, DIN EN 60900. IEC 900. Each piece is "GS" safety tested. Blade made from fully hardened, high-alloy chromium-vanadium-molybdenum steel, gun-metal finish.

General ordering data

Type	SDIK PZ1 SL	Version
Order No.	1274730000	Mounting tool, Blade length: 80 mm
GTIN (EAN)	4050118073225	
Qty.	1 pc(s).	

Crosshead screwdriver Pozidriv



Crosshead screwdriver, Pozidriv, SDK PZ DIN 5262, ISO 8764/2-PZ, output to ISO 8764/1-PZ, ChromTop tip, SoftFinish grip

General ordering data

Type	SDK PZ1	Version
Order No.	9008530000	Screwdriver, Blade width (B): 4.5 mm, Blade length: 80 mm
GTIN (EAN)	4032248056521	
Qty.	1 pc(s).	

RIDERSERIES RCI RCIKIT 24VDC 1CO LD

Weidmüller Interface GmbH & Co. KG
 Klingenbergstraße 26
 D-32758 Detmold
 Germany
 Fon: +49 5231 14-0
 Fax: +49 5231 14-292083
 www.weidmueller.com

Accessories

LED / free-wheel diode



Pluggable protective modules for the RIDERSERIES RCI / RCM relay base, with optional protective functions.

- With either green or red LED
- With free-wheel diode
- For DC supply voltage

General ordering data

Type	RIM-I 2 6/24VDC	Version
Order No.	8869590000	RIDERSERIES, LED module with freewheel diode, Rated control
GTIN (EAN)	4032248614530	voltage: 6...24 V DC, Plug-in connection
Qty.	10 pc(s).	
Type	RIM-I 2 24/60VDC	Version
Order No.	8869670000	RIDERSERIES, LED module with freewheel diode, Rated control
GTIN (EAN)	4032248614608	voltage: 24...60 V DC, Plug-in connection
Qty.	10 pc(s).	
Type	RIM-I 2 24/60VDC GN	Version
Order No.	8869680000	RIDERSERIES, LED module with freewheel diode, Rated control
GTIN (EAN)	4032248614615	voltage: 24...60 V DC, Plug-in connection
Qty.	10 pc(s).	
Type	RIM-I 2 6/24VDC GN	Version
Order No.	8869600000	RIDERSERIES, LED module with freewheel diode, Rated control
GTIN (EAN)	4032248614547	voltage: 6...24 V DC, Plug-in connection
Qty.	10 pc(s).	

LED / Protective varistor



Pluggable protective modules for the RIDERSERIES RCI / RCM relay base, with optional protective functions.

- With protective varistor
- For UC supply voltage

General ordering data

Type	RIM-I 4 24VUC VAR	Version
Order No.	8869710000	RIDERSERIES, Protective varistor, Rated control voltage: 24 V UC, Plug-
GTIN (EAN)	4032248606344	in connection
Qty.	10 pc(s).	

**RIDERSERIES RCI
RCIKIT 24VDC 1CO LD**

Weidmüller Interface GmbH & Co. KG
 Klingenbergstraße 26
 D-32758 Detmold
 Germany
 Fon: +49 5231 14-0
 Fax: +49 5231 14-292083
 www.weidmueller.com

Accessories

Blank



ESG is the tried-and-tested marker in MultiCard format for use on many well-known electrical devices. The result is high-quality device marking with a high-contrast appearance.

Various types are available for devices from the following manufacturers:

- Siemens
- Télémecanique
- ABB
- Beckhoff
- Lumberg
- Tags for all-purpose usage; self-adhesive or clip-on tags, depending on the type

Advantages at a glance:

- Tags for universal usage, self-adhesive or clip-on tags, depending on type
- For aligned equipment, e.g. circuit breakers, we supply ESG markers for clipping onto tag rails
- Individual laser-quality printing according to specifications

For custom printing: Please send us a file of our labeling software M-Print PRO or M-Print PRO Online (without installation) for your labeling specifications.

Please note that these markers are not intended for printing with the SpeedMarking laser.

General ordering data

Type	ESG 6/15 K MC NE GE	Version
Order No.	1880130000	ESG, Device markers x 15 mm, PA 66, Colour: yellow, Self-adhesive
GTIN (EAN)	4032248478910	
Qty.	200 pc(s).	
Type	ESG 6/15 K MC NE WS	Version
Order No.	1880100000	ESG, Device markers x 15 mm, PA 66, Colour: white, Self-adhesive
GTIN (EAN)	4032248478781	
Qty.	200 pc(s).	

**RIDERSERIES RCI
RCIKIT 24VDC 1CO LD**

Weidmüller Interface GmbH & Co. KG
 Klingenbergstraße 26
 D-32758 Detmold
 Germany
 Fon: +49 5231 14-0
 Fax: +49 5231 14-292083
 www.weidmueller.com

Accessories
Crosshead screwdriver Pozidriv

VDE insulated crosshead screwdriver type Pozidriv SDIK PZ DIN 7438, ISO 8764/2-PZ, output to ISO 8764-PZ, SoftFinish grip

General ordering data

Type	SDIK PZ1	Version
Order No.	9008900000	Screwdriver, Blade length: 80 mm
GTIN (EAN)	4032248266685	
Qty.	1 pc(s).	

Cross-connection for socket with screw connection

In an industrial environment, service work needs to be carried out quickly, simply and reliably. If components are replaced, bended relay contacts often cause errors which are difficult to locate.

As the handling of components in practice plays an increasingly important role, DRI relays have particularly stable plug contacts for quick and safe mounting. The test button with latching in end position can be operated tool-free. An easily visible, LED illuminated status display also allows clear determination of status.

Both during installation of the cabinet and during subsequent servicing in the machinery and plant engineering sector, DRI relays are the optimum coupling element for confined installation conditions.

General ordering data

Type	SRC-I QV S	Version
Order No.	1132070000	RIDERSERIES RCI, Cross-connector
GTIN (EAN)	4032248912087	
Qty.	10 pc(s).	

**RIDERSERIES RCI
RCIKIT 24VDC 1CO LD**

Weidmüller Interface GmbH & Co. KG
Klingenbergstraße 26
D-32758 Detmold
Germany
Fon: +49 5231 14-0
Fax: +49 5231 14-292083
www.weidmueller.com

Accessories

Retaining clip



- Coupling relay with positively driven contacts: for monitoring signals within safety-critical circuits
- Relays with positively driven contacts have a 99% diagnostics coverage and an excellent reputation for use in safety systems.
- The contacts interlock with each other in order to ensure a synchronous switching status between both contacts. This guarantees that the alert contact will maintain the same switching status in the event of an error (for example, if the working contact melts from an overload).

General ordering data

Type	SRC-I CLIP HM RCI	Version	
Order No.	1132090000		RIDERSERIES RCI, Retaining clip
GTIN (EAN)	4032248912209		
Qty.	20 pc(s).		

Plastic retaining clip

Plastic retaining clip for RIDERSERIES RCI relays



General ordering data

Type	SRC-I CLIP HP	Version	
Order No.	8869510000		RIDERSERIES RCI, Retaining clip
GTIN (EAN)	4032248614462		
Qty.	10 pc(s).		

**RIDERSERIES RCI
RCIKIT 24VDC 1CO LD**

Weidmüller Interface GmbH & Co. KG
 Klingenbergstraße 26
 D-32758 Detmold
 Germany
 Fon: +49 5231 14-0
 Fax: +49 5231 14-292083
 www.weidmueller.com

Accessories

Protection module

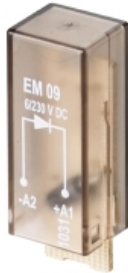

Pluggable protective modules for the RIDERSERIES RCI / RCM relay base, with optional protective functions.

- Optionally with free-wheel diode, load resistor or RC filter

General ordering data

Type	RIM-I 1 6/230V	Version
Order No.	8869580000	RIDERSERIES, Free-wheeling diode, Rated control voltage: 6...230 V
GTIN (EAN)	4032248614523	DC, Plug-in connection
Qty.	10 pc(s).	