

**RIDERSERIES RCI**  
**RCI424024****Weidmüller Interface GmbH & Co. KG**  
Klingenbergstraße 26  
D-32758 Detmold  
Germany  
Fon: +49 5231 14-0  
Fax: +49 5231 14-292083  
www.weidmueller.com**Product image**

Similar to illustration

Standard relay within the RIDERSERIES RCI.

- 2 CO contacts
- optionally: AC or DC coils

**General ordering data**

Type	RCI424024
Order No.	<a href="#">8869890000</a>
Version	RIDERSERIES RCI, Relay, Number of contacts: 2 CO contact AgNi 90/10, Rated control voltage: 24 V DC, Continuous current: 8 A, Plug-in connection
GTIN (EAN)	4032248613236
Qty.	10 pc(s).

Creation date May 1, 2020 6:03:20 AM CEST

Catalogue status 17.04.2020 / We reserve the right to make technical changes.

**RIDERSERIES RCI**  
**RCI424024**

**Weidmüller Interface GmbH & Co. KG**  
 Klingenbergstraße 26  
 D-32758 Detmold  
 Germany  
 Fon: +49 5231 14-0  
 Fax: +49 5231 14-292083  
 www.weidmueller.com

**Technical data****Dimensions and weights**

Width	13 mm	Width (inches)	0.512 inch
Height	29 mm	Height (inches)	1.142 inch
Depth	25.6 mm	Depth (inches)	1.008 inch
Net weight	16.629 g		

**Temperatures**

Humidity	40 °C / 93 % rel. humidity, no condensation	Operating temperature, max.	70 °C
Operating temperature, min.	-40 °C	Storage temperature, max.	85 °C
Storage temperature, min.	-40 °C	Operating temperature	-40 °C...70 °C
Storage temperature	-40 °C...85 °C		

**Rated data UL**

Certificate No. (cURus)	E224238
-------------------------	---------

**Input**

Rated control voltage	24 V DC	Rated current DC	16.7 mA
Power rating	400 mW	Pull-in/drop-out voltage, typ.	16.8 V / 2.4 V DC
Coil resistance	1440 Ω ± 10 %		

**Output**

Rated switching voltage	240 V AC	Max. switching voltage, AC	400 V
Continuous current	8 A	Inrush current	15 A / 4 s
AC switching capacity (resistive), max.	2000 VA	DC switching capacity (resistive), max.	192 W @ 24 V
Switch-on delay	≤ 10 ms	Switch-off delay	≤ 6 ms
Min. switching power	1 mA @ 24 V, 10 mA @ 12 V, 100 mA @ 5 V	Max. switching frequency at rated load	0.1 Hz

**Contact data**

Contact type	2 CO contact (AgNi 90/10)	Mechanical service life	AC coil 5 x 10 <sup>6</sup> switching cycles, DC coil 10 x 10 <sup>6</sup> switching cycles
--------------	---------------------------	-------------------------	---

**General data**

Test button	No	Mechanical switch position indicator	No
Colour	Transparent	UL 94 flammability rating	V-2

**Insulation coordination**

Rated voltage	250 V	Surge voltage category	III
Pollution severity	2	Insulating material group	IIIa
Dielectric strength, Input/Output	5 kV <sub>eff</sub> / 1min	Creepage and clearance distance input – output	≥ 8 mm
Dielectric strength of neighbouring contacts	2.5 kV <sub>eff</sub> / 1 Min.	Dielectric strength of open contact	1 kV <sub>eff</sub> / 1 min
Impulse withstand voltage	5 kV (1.2/50 μs)		

## Data sheet

### RIDERSERIES RCI RCI424024

**Weidmüller Interface GmbH & Co. KG**  
 Klingenbergstraße 26  
 D-32758 Detmold  
 Germany  
 Fon: +49 5231 14-0  
 Fax: +49 5231 14-292083  
 www.weidmueller.com

## Technical data

### Further details of approvals / standards

Standards	IEC 61810-1, UL508	Certificate No. (CSA)	249409-2426937
Certificate No. (cURus)	E224238		

### Connection data

Wire connection method	Plug-in connection	Pitch in mm (P)	5 mm
------------------------	--------------------	-----------------	------

### Classifications

ETIM 6.0	EC001437	ETIM 7.0	EC001437
eClass 9.0	27-37-16-01	eClass 9.1	27-37-16-01
eClass 10.0	27-37-16-01	UNSPSC	30-21-19-17

### Approvals

Approvals



ROHS Conform

### Downloads

Approval/Certificate/Document of Conformity	<a href="#">EU Konformitätserklärung / EU Declaration of Conformity</a>
Brochure/Catalogue	<a href="#">CAT 4.2 ELECTR 18/19 EN</a>
Engineering Data	<a href="#">EPLAN, WSCAD</a>
Engineering Data	<a href="#">STEP</a>

**RIDERSERIES RCI**  
**RCI424024**

**Weidmüller Interface GmbH & Co. KG**  
Klingenbergstraße 26  
D-32758 Detmold  
Germany  
Fon: +49 5231 14-0  
Fax: +49 5231 14-292083  
www.weidmueller.com

**Drawings**

**Wiring diagram**



View of Pins from below

**Graph**

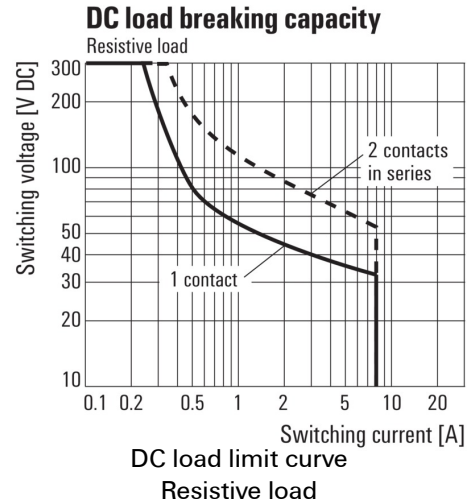

**Graph**

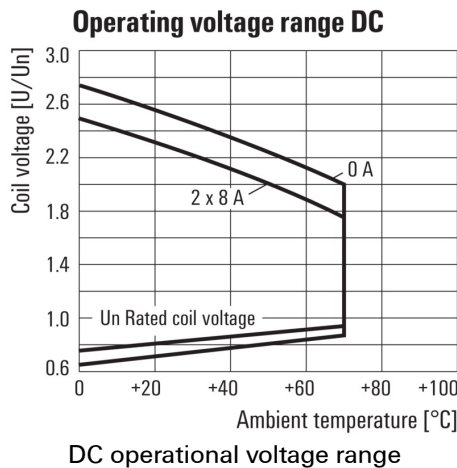

**Graph**

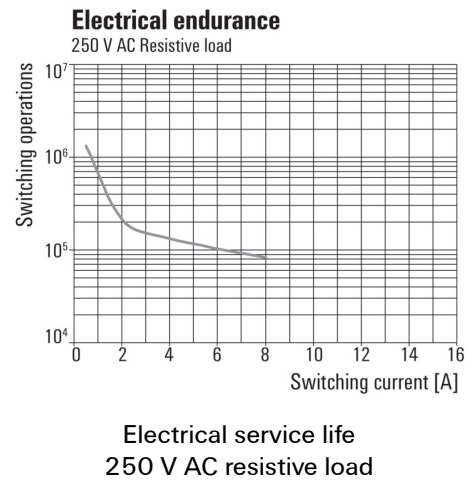

**Graph**

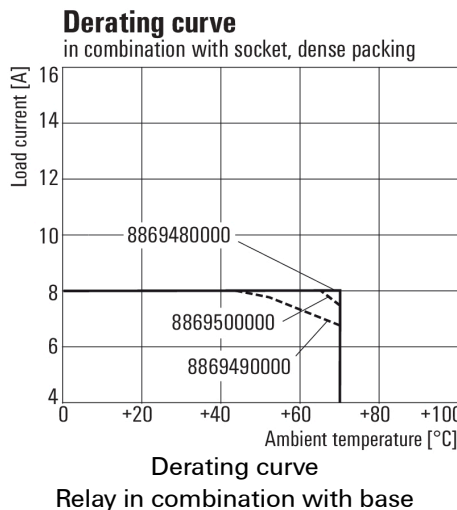

**Dimensional drawing**

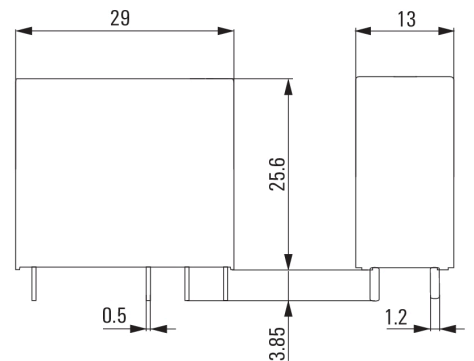

**RIDERSERIES RCI  
RCI424024**

**Weidmüller Interface GmbH & Co. KG**  
Klingenbergstraße 26  
D-32758 Detmold  
Germany  
Fon: +49 5231 14-0  
Fax: +49 5231 14-292083  
www.weidmueller.com

**Mating connector (fully pluggable)**

**Base**



Relay base for the RIDERSERIES RCI relays

- 1 and 2 CO contacts
- Screw and PUSH IN connection
- Standard and low heights

**General ordering data**

Type	SRC-I 2CO N	Version
Order No.	<a href="#">8869480000</a>	RIDERSERIES RCI, Relay bases, Number of contacts: 2 CO contact,
GTIN (EAN)	4032248614431	Continuous current: 12 A, 16 A <sup>1</sup> , Screw connection
Qty.	10 pc(s).	
Type	SRC-I 2CO	Version
Order No.	<a href="#">8869490000</a>	RIDERSERIES RCI, Relay bases, Number of contacts: 2 CO contact,
GTIN (EAN)	4032248614448	Continuous current: 12 A, 16 A <sup>1</sup> , Screw connection
Qty.	10 pc(s).	
Type	SRC-I 2CO P	Version
Order No.	<a href="#">8869500000</a>	RIDERSERIES RCI, Relay bases, Number of contacts: 2 CO contact,
GTIN (EAN)	4032248614455	Continuous current: 12 A, 16 A <sup>1</sup> , PUSH IN
Qty.	10 pc(s).	

**RIDERSERIES RCI  
RCI424024**

**Weidmüller Interface GmbH & Co. KG**  
Klingenbergstraße 26  
D-32758 Detmold  
Germany  
Fon: +49 5231 14-0  
Fax: +49 5231 14-292083  
www.weidmueller.com

**Accessories**

**Label (cannot be printed using PrintJet)**



Weidmüller RIDERSERIES relays guarantee a noise-free, decoupled signal transmission in industrial automation concepts. They are compact, quickly installed and can be fitted in the tightest of spaces.

- 1 or 2 CO contacts
- optionally: AC or DC coils
- Relay optionally with integrated status display and/or free-wheel diode and optionally combined with a test button
- pluggable LED modules with protective functions
- Metal and plastic retaining clips
- Base with screw / PUSH IN connection

**General ordering data**

Type	SRC-I MARK	Version	
Order No.	<a href="#">8869530000</a>	RIDERSERIES RCI, Label	
GTIN (EAN)	4032248614479		
Qty.	10 pc(s).		

**Cross-connection for base with PUSH IN connection**



Weidmüller RIDERSERIES relays guarantee a noise-free, decoupled signal transmission in industrial automation concepts. They are compact, quickly installed and can be fitted in the tightest of spaces.

- 1 or 2 CO contacts
- optionally: AC or DC coils
- Relay optionally with integrated status display and/or free-wheel diode and optionally combined with a test button
- pluggable LED modules with protective functions
- Metal and plastic retaining clips
- Base with screw / PUSH IN connection

**General ordering data**

Type	SRC-I QV P	Version	
Order No.	<a href="#">8870840000</a>	RIDERSERIES RCI, Cross-connector	
GTIN (EAN)	4032248631681		
Qty.	10 pc(s).		

## RIDERSERIES RCI RCI424024

**Weidmüller Interface GmbH & Co. KG**  
 Klingenbergstraße 26  
 D-32758 Detmold  
 Germany  
 Fon: +49 5231 14-0  
 Fax: +49 5231 14-292083  
 www.weidmueller.com

## Accessories

### LED

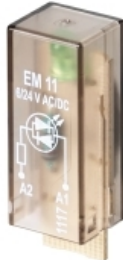

Pluggable protective modules for the RIDERSERIES RCI / RCM relay base, with optional protective functions.

- With either green or red LED
- For UC supply voltage

### General ordering data

Type	RIM-I 3 6/24VUC	Version
Order No.	<a href="#">8869630000</a>	RIDERSERIES, LED module, Rated control voltage: 6...24 V UC, Plug-in connection
GTIN (EAN)	4032248614578	
Qty.	10 pc(s).	
Type	RIM-I 3 24/60VUC	Version
Order No.	<a href="#">8869610000</a>	RIDERSERIES, LED module, Rated control voltage: 24...60 V UC, Plug-in connection
GTIN (EAN)	4032248614554	
Qty.	10 pc(s).	
Type	RIM-I 3 6/24VUC GN	Version
Order No.	<a href="#">8869640000</a>	RIDERSERIES, LED module, Rated control voltage: 6...24 V UC, Plug-in connection
GTIN (EAN)	4032248614585	
Qty.	10 pc(s).	
Type	RIM-I 3 24/60VUC GN	Version
Order No.	<a href="#">8869620000</a>	RIDERSERIES, LED module, Rated control voltage: 24...60 V UC, Plug-in connection
GTIN (EAN)	4032248614561	
Qty.	10 pc(s).	

### Base



Relay base for the RIDERSERIES RCI relays

- 1 and 2 CO contacts
- Screw and PUSH IN connection
- Standard and low heights

### General ordering data

Type	SRC-I 2CO N	Version
Order No.	<a href="#">8869480000</a>	RIDERSERIES RCI, Relay bases, Number of contacts: 2 CO contact, Continuous current: 12 A, 16 A <sup>1</sup> , Screw connection
GTIN (EAN)	4032248614431	
Qty.	10 pc(s).	
Type	SRC-I 2CO	Version
Order No.	<a href="#">8869490000</a>	RIDERSERIES RCI, Relay bases, Number of contacts: 2 CO contact, Continuous current: 12 A, 16 A <sup>1</sup> , Screw connection
GTIN (EAN)	4032248614448	
Qty.	10 pc(s).	

## RIDERSERIES RCI RCI424024

**Weidmüller Interface GmbH & Co. KG**  
 Klingenbergstraße 26  
 D-32758 Detmold  
 Germany  
 Fon: +49 5231 14-0  
 Fax: +49 5231 14-292083  
 www.weidmueller.com

## Accessories

Type	SRC-I 2CO P	Version
Order No.	<a href="#">8869500000</a>	RIDERSERIES RCI, Relay bases, Number of contacts: 2 CO contact,
GTIN (EAN)	4032248614455	Continuous current: 12 A, 16 A <sup>1</sup> , PUSH IN
Qty.	10 pc(s).	

## LED / free-wheel diode



Pluggable protective modules for the RIDERSERIES RCI / RCM relay base, with optional protective functions.

- With either green or red LED
- With free-wheel diode
- For DC supply voltage

## General ordering data

Type	RIM-I 2 6/24VDC	Version
Order No.	<a href="#">8869590000</a>	RIDERSERIES, LED module with freewheel diode, Rated control
GTIN (EAN)	4032248614530	voltage: 6...24 V DC, Plug-in connection
Qty.	10 pc(s).	
Type	RIM-I 2 24/60VDC	Version
Order No.	<a href="#">8869670000</a>	RIDERSERIES, LED module with freewheel diode, Rated control
GTIN (EAN)	4032248614608	voltage: 24...60 V DC, Plug-in connection
Qty.	10 pc(s).	
Type	RIM-I 2 24/60VDC GN	Version
Order No.	<a href="#">8869680000</a>	RIDERSERIES, LED module with freewheel diode, Rated control
GTIN (EAN)	4032248614615	voltage: 24...60 V DC, Plug-in connection
Qty.	10 pc(s).	
Type	RIM-I 2 6/24VDC GN	Version
Order No.	<a href="#">8869600000</a>	RIDERSERIES, LED module with freewheel diode, Rated control
GTIN (EAN)	4032248614547	voltage: 6...24 V DC, Plug-in connection
Qty.	10 pc(s).	



## RIDERSERIES RCI RCI424024

**Weidmüller Interface GmbH & Co. KG**  
 Klingenbergstraße 26  
 D-32758 Detmold  
 Germany  
 Fon: +49 5231 14-0  
 Fax: +49 5231 14-292083  
 www.weidmueller.com

# Accessories

### LED / Protective varistor



Pluggable protective modules for the RIDERSERIES RCI / RCM relay base, with optional protective functions.

- With protective varistor
- For UC supply voltage

### General ordering data

Type	RIM-I 4 24VUC VAR	Version
Order No.	<a href="#">8869710000</a>	RIDERSERIES, Protective varistor, Rated control voltage: 24 V UC, Plug-
GTIN (EAN)	4032248606344	in connection
Qty.	10 pc(s).	

### Cross-connection for socket with screw connection



In an industrial environment, service work needs to be carried out quickly, simply and reliably. If components are replaced, bended relay contacts often cause errors which are difficult to locate.

As the handling of components in practice plays an increasingly important role, DRI relays have particularly stable plug contacts for quick and safe mounting. The test button with latching in end position can be operated tool-free. An easily visible, LED illuminated status display also allows clear determination of status.

Both during installation of the cabinet and during subsequent servicing in the machinery and plant engineering sector, DRI relays are the optimum coupling element for confined installation conditions.

### General ordering data

Type	SRC-I QV S	Version
Order No.	<a href="#">1132070000</a>	RIDERSERIES RCI, Cross-connector
GTIN (EAN)	4032248912087	
Qty.	10 pc(s).	

**RIDERSERIES RCI  
RCI424024**

**Weidmüller Interface GmbH & Co. KG**  
 Klingenbergstraße 26  
 D-32758 Detmold  
 Germany  
 Fon: +49 5231 14-0  
 Fax: +49 5231 14-292083  
 www.weidmueller.com

**Accessories**

**Retaining clip**



- Coupling relay with positively driven contacts: for monitoring signals within safety-critical circuits
- Relays with positively driven contacts have a 99% diagnostics coverage and an excellent reputation for use in safety systems.
- The contacts interlock with each other in order to ensure a synchronous switching status between both contacts. This guarantees that the alert contact will maintain the same switching status in the event of an error (for example, if the working contact melts from an overload).

**General ordering data**

Type	SRC-I CLIP HM RCI	Version	
Order No.	<a href="#">1132090000</a>		RIDERSERIES RCI, Retaining clip
GTIN (EAN)	4032248912209		
Qty.	20 pc(s).		

**Plastic retaining clip**

Plastic retaining clip for RIDERSERIES RCI relays



**General ordering data**

Type	SRC-I CLIP HP	Version	
Order No.	<a href="#">8869510000</a>		RIDERSERIES RCI, Retaining clip
GTIN (EAN)	4032248614462		
Qty.	10 pc(s).		

**RIDERSERIES RCI  
RCI424024**

**Weidmüller Interface GmbH & Co. KG**  
 Klingenbergstraße 26  
 D-32758 Detmold  
 Germany  
 Fon: +49 5231 14-0  
 Fax: +49 5231 14-292083  
 www.weidmueller.com

**Accessories**

**Protection module**



Pluggable protective modules for the RIDERSERIES RCI / RCM relay base, with optional protective functions.

- Optionally with free-wheel diode, load resistor or RC filter

**General ordering data**

Type	RIM-I 1 6/230V	Version
Order No.	<a href="#">8869580000</a>	RIDERSERIES, Free-wheeling diode, Rated control voltage: 6...230 V
GTIN (EAN)	4032248614523	DC, Plug-in connection
Qty.	10 pc(s).	

**RIDERSERIES RCI  
RCI424024**

**Weidmüller Interface GmbH & Co. KG**  
 Klingenbergstraße 26  
 D-32758 Detmold  
 Germany  
 Fon: +49 5231 14-0  
 Fax: +49 5231 14-292083  
 www.weidmueller.com

**Drawings**

**Miscellaneous**

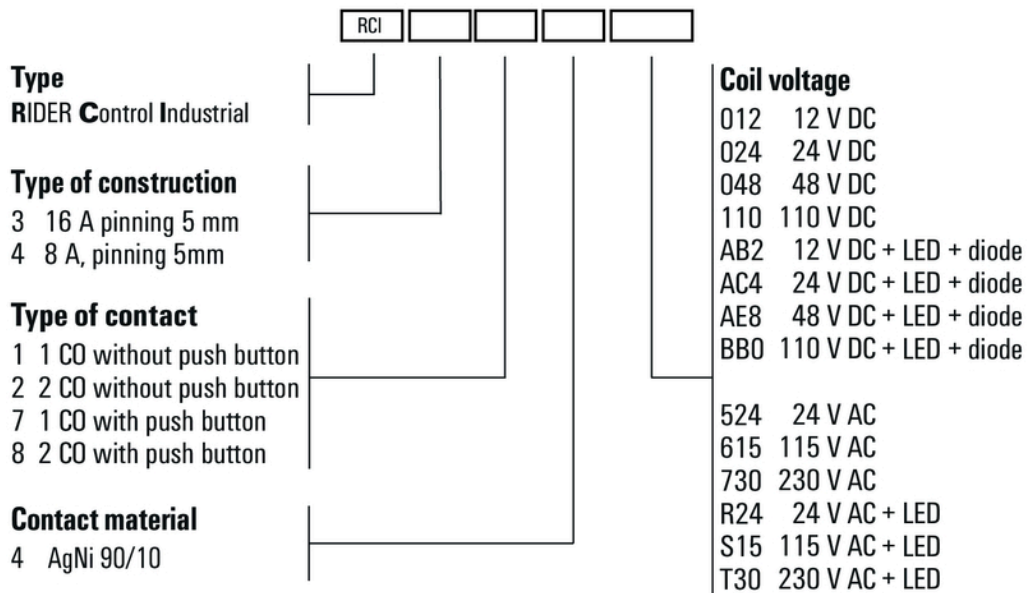

Type codes