

**RIDERSERIES RCM
RCM270R12**

Weidmüller Interface GmbH & Co. KG
Klingenbergstraße 26
D-32758 Detmold
Germany
Fon: +49 5231 14-0
Fax: +49 5231 14-292083
www.weidmueller.com

Product image

Similar to illustration

Standard relays in the RIDERSERIES RCM

- 2 CO contacts
- Optionally AC or DC coils
- with test button
- Comes optionally with integrated status display and/or free-wheel diode

General ordering data

| | |
|------------|--|
| Type | RCM270R12 |
| Order No. | 8689750000 |
| Version | RIDERSERIES RCM, Relay, Number of contacts: 2 CO contact with test button AgNi 90/10, Rated control voltage: 12 V AC, Continuous current: 12 A, Plug-in connection |
| GTIN (EAN) | 4032248360420 |
| Qty. | 10 pc(s). |

Creation date May 1, 2020 7:07:56 AM CEST

Catalogue status 17.04.2020 / We reserve the right to make technical changes.

**RIDERSERIES RCM
RCM270R12**

Weidmüller Interface GmbH & Co. KG
 Klingenbergstraße 26
 D-32758 Detmold
 Germany
 Fon: +49 5231 14-0
 Fax: +49 5231 14-292083
 www.weidmueller.com

Technical data**Dimensions and weights**

| | | | |
|------------|---------|-----------------|------------|
| Width | 22.5 mm | Width (inches) | 0.886 inch |
| Height | 28 mm | Height (inches) | 1.102 inch |
| Depth | 29 mm | Depth (inches) | 1.142 inch |
| Net weight | 29.7 g | | |

Temperatures

| | | | |
|-----------------------------|--|-----------------------------|----------------|
| Humidity | 40 °C / 93 % rel. humidity, no condensation | Operating temperature, max. | 70 °C |
| Operating temperature, min. | -40 °C | Storage temperature, max. | 85 °C |
| Storage temperature, min. | -40 °C | Operating temperature | -40 °C...70 °C |
| Storage temperature | -40 °C...85 °C | | |

Rated data UL

| | |
|-------------------------|---------|
| Certificate No. (cURus) | E224238 |
|-------------------------|---------|

Input

| | | | |
|-----------------------|--------------|--------------------------------|------------------|
| Rated control voltage | 12 V AC | Rated current AC | 83.3 mA |
| Power rating | 1.0 VA | Pull-in/drop-out voltage, typ. | 9.6 V / 3.6 V AC |
| Coil resistance | 192 Ω ± 10 % | Status indicator | red LED |

Output

| | | | |
|---|---|---|--------------|
| Rated switching voltage | 240 V AC | Max. switching voltage, AC | 400 V |
| Continuous current | 12 A | Inrush current | 24 A / 20 ms |
| AC switching capacity (resistive), max. | 3000 VA | DC switching capacity (resistive), max. | 288 W @ 24 V |
| Switch-on delay | ≤ 15 ms | Switch-off delay | ≤ 10 ms |
| Min. switching power | 1 mA @ 24 V, 10 mA @ 12 V, 100 mA @ 5 V | Max. switching frequency at rated load | 0.1 Hz |

Contact data

| | | | |
|--------------|--|-------------------------|--|
| Contact type | 2 CO contact with test button (AgNi 90/10) | Mechanical service life | AC coil 20 x 10 ⁶ switching cycles, DC coil 30 x 10 ⁶ switching cycles |
|--------------|--|-------------------------|--|

General data

| | | | |
|-------------|----------------|--------------------------------------|-----|
| Test button | yes (lockable) | Mechanical switch position indicator | Yes |
| Colour | Transparent | UL 94 flammability rating | V-2 |

Insulation coordination

| | | | |
|--|--------------------------------|--|--------------------------------|
| Rated voltage | 250 V | Surge voltage category | III |
| Pollution severity | 2 | Insulating material group | IIIa |
| Protection degree | IP20 | Dielectric strength, Input/Output | 2.5 kV _{eff} / 1 Min. |
| Creepage and clearance distance input - output | ≥ 4 mm | Dielectric strength of neighbouring contacts | 2.5 kV _{eff} / 1 Min. |
| Dielectric strength of open contact | 1.2 kV _{eff} / 1 min. | Impulse withstand voltage | 5 kV (1.2/50 μs) |

Data sheet

**RIDERSERIES RCM
RCM270R12**

Weidmüller Interface GmbH & Co. KG
 Klingenbergstraße 26
 D-32758 Detmold
 Germany
 Fon: +49 5231 14-0
 Fax: +49 5231 14-292083
 www.weidmueller.com

Technical data

Further details of approvals / standards

| | | | |
|-------------------------|--------------------|-----------------------|----------------|
| Standards | IEC 61810-1, UL508 | Certificate No. (CSA) | 249409-2426937 |
| Certificate No. (cURus) | E224238 | | |

Connection data

| | |
|------------------------|--------------------|
| Wire connection method | Plug-in connection |
|------------------------|--------------------|

Classifications

| | | | |
|-------------|-------------|------------|-------------|
| ETIM 6.0 | EC001437 | ETIM 7.0 | EC001437 |
| eClass 9.0 | 27-37-16-01 | eClass 9.1 | 27-37-16-01 |
| eClass 10.0 | 27-37-16-01 | UNSPSC | 30-21-19-17 |

Approvals

Approvals



| | |
|------|---------|
| ROHS | Conform |
|------|---------|

Downloads

| | |
|---|---|
| Approval/Certificate/Document of Conformity | EU Konformitätserklärung / EU Declaration of Conformity |
| Engineering Data | EPLAN, WSCAD |
| Engineering Data | STEP |

**RIDERSERIES RCM
RCM270R12**

Weidmüller Interface GmbH & Co. KG
Klingenbergstraße 26
D-32758 Detmold
Germany
Fon: +49 5231 14-0
Fax: +49 5231 14-292083
www.weidmueller.com

Drawings

Wiring diagram

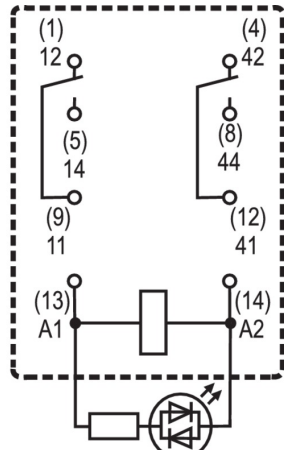

View of Pins from below

Graph

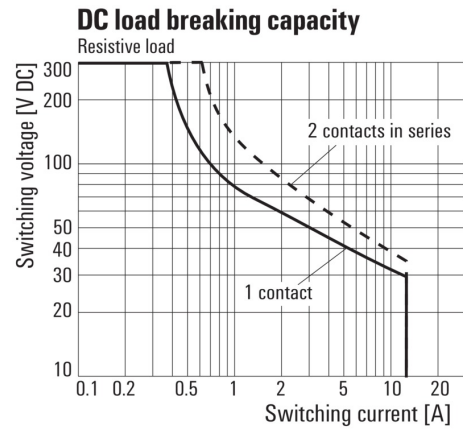

DC load limit curve
Resistive load

Graph

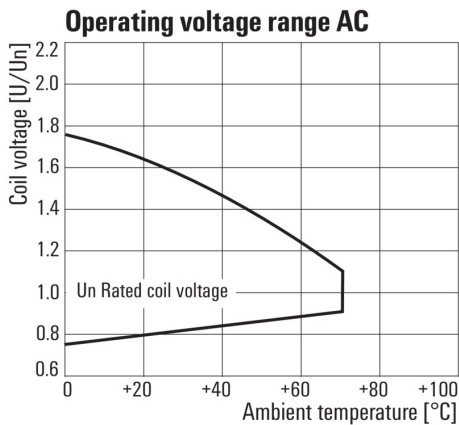

AC operational voltage range

Graph

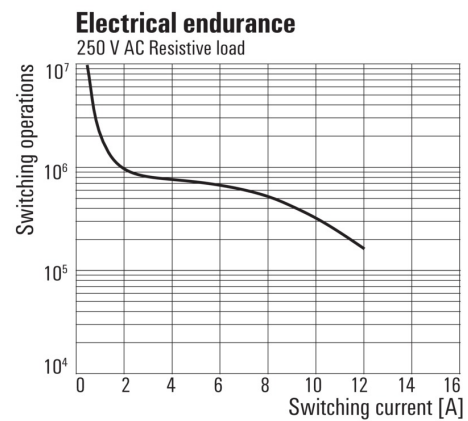

Electrical service life
250 V AC resistive load

Graph

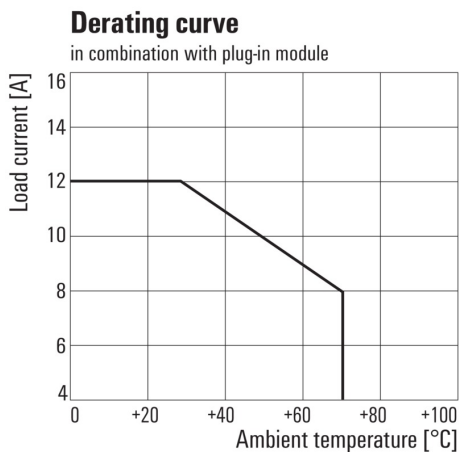

Derating curve
Relay in combination with base

Dimensional drawing



**RIDERSERIES RCM
RCM270R12**

Weidmüller Interface GmbH & Co. KG
 Klingenbergstraße 26
 D-32758 Detmold
 Germany
 Fon: +49 5231 14-0
 Fax: +49 5231 14-292083
 www.weidmueller.com

Mating connector (fully pluggable)
Base

Relay base for RIDERSERIES RCM relays

- 2, 3 and 4 CO contacts
- Screw and PUSH IN wire connection
- Standard and low heights

General ordering data

| | | |
|------------|----------------------------|---|
| Type | SCM-I 2CO P | Version |
| Order No. | 8876220000 | RIDERSERIES RCM, Relay bases, Number of contacts: 2 CO contact, |
| GTIN (EAN) | 4032248609031 | Continuous current: 12 A, PUSH IN |
| Qty. | 10 pc(s). | |
| Type | SCM-I 4CO P | Version |
| Order No. | 8869430000 | RIDERSERIES RCM, Relay bases, Number of contacts: 4 CO contact, |
| GTIN (EAN) | 4032248614288 | Continuous current: 6 A, PUSH IN |
| Qty. | 10 pc(s). | |
| Type | SCM-I 4CO N | Version |
| Order No. | 8869390000 | RIDERSERIES RCM, Relay bases, Number of contacts: 4 CO contact, |
| GTIN (EAN) | 4032248614257 | Continuous current: 6 A, Screw connection |
| Qty. | 10 pc(s). | |
| Type | SCM-I 4CO | Version |
| Order No. | 8869420000 | RIDERSERIES RCM, Relay bases, Number of contacts: 4 CO contact, |
| GTIN (EAN) | 4032248614271 | Continuous current: 6 A, Screw connection |
| Qty. | 10 pc(s). | |
| Type | SCM-I 2CO | Version |
| Order No. | 8869400000 | RIDERSERIES RCM, Relay bases, Number of contacts: 2 CO contact, |
| GTIN (EAN) | 4032248614264 | Continuous current: 12 A, Screw connection |
| Qty. | 10 pc(s). | |

**RIDERSERIES RCM
RCM270R12**

Weidmüller Interface GmbH & Co. KG
Klingenbergstraße 26
D-32758 Detmold
Germany
Fon: +49 5231 14-0
Fax: +49 5231 14-292083
www.weidmueller.com

Accessories

LED

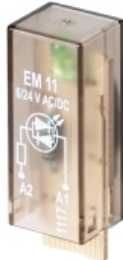

Pluggable protective modules for the RIDERSERIES RCI / RCM relay base, with optional protective functions.

- With either green or red LED
- For UC supply voltage

General ordering data

| | | |
|------------|----------------------------|---|
| Type | RIM-I 3 6/24VUC | Version |
| Order No. | 8869630000 | RIDERSERIES, LED module, Rated control voltage: 6...24 V UC, Plug-in connection |
| GTIN (EAN) | 4032248614578 | |
| Qty. | 10 pc(s). | |
| Type | RIM-I 3 6/24VUC GN | Version |
| Order No. | 8869640000 | RIDERSERIES, LED module, Rated control voltage: 6...24 V UC, Plug-in connection |
| GTIN (EAN) | 4032248614585 | |
| Qty. | 10 pc(s). | |

Plastic retaining clip



Plastic retaining clip for RIDERSERIES RCM relays

General ordering data

| | | |
|------------|----------------------------|---------------------------------|
| Type | SCM-I CLIP P | Version |
| Order No. | 8869440000 | RIDERSERIES RCM, Retaining clip |
| GTIN (EAN) | 4032248614295 | |
| Qty. | 10 pc(s). | |
| Type | SCM-I CLIP N | Version |
| Order No. | 8875620000 | RIDERSERIES RCM, Retaining clip |
| GTIN (EAN) | 4032248608577 | |
| Qty. | 10 pc(s). | |

**RIDERSERIES RCM
RCM270R12**

Weidmüller Interface GmbH & Co. KG
 Klingenbergstraße 26
 D-32758 Detmold
 Germany
 Fon: +49 5231 14-0
 Fax: +49 5231 14-292083
 www.weidmueller.com

Accessories

Cross-connection for base with PUSH IN connection



Weidmüller RIDERSERIES relays guarantee a noise-free, decoupled signal transmission in industrial automation concepts.

The are compact, quickly installed and can be fitted in the tightest of spaces.

- 2, 3 or 4 CO contacts
- optionally: AC or DC coils
- Relay with test button and integrated status display and/or free-wheel diode
- Optionally with hard gold plated 4 CO contacts
- pluggable LED modules with protective functions
- Metal and plastic retaining clips
- Base with screw / PUSH IN connection

General ordering data

| | | | |
|------------|----------------------------|---------|----------------------------------|
| Type | SCM-H QV P | Version | |
| Order No. | 8870850000 | | RIDERSERIES RCM, Cross-connector |
| GTIN (EAN) | 4032248631698 | | |
| Qty. | 10 pc(s). | | |

RIDERSERIES RCM RCM270R12

Weidmüller Interface GmbH & Co. KG
 Klingenbergstraße 26
 D-32758 Detmold
 Germany
 Fon: +49 5231 14-0
 Fax: +49 5231 14-292083
 www.weidmueller.com

Accessories

Cross-connection for base with screw connection



You place stringent demands on your relay combinations in industrial environments. Our D-SERIES relay modules were designed specifically for challenging industrial applications. Let's connect. In many industrial applications voltages between 110 and 220 V are used to control actuators. With load currents exceeding 100 mA these high voltages produce arcing that causes a great deal of wear on the relay contacts. We have designed our D-SERIES relay modules specifically for universal usage in a wide range of industrial applications. They are much more reliable than conventional solutions, which minimises costs for maintenance and replacement. Thanks to series connected contacts, built-in blow magnets and low-wear contacts, arcing is effectively suppressed with D-SERIES products – resulting in a noticeably longer service life.

General ordering data

| | | |
|------------|----------------------------|----------------------------------|
| Type | SCM-I QV S | Version |
| Order No. | 1132080000 | RIDERSERIES RCM, Cross-connector |
| GTIN (EAN) | 4032248912193 | |
| Qty. | 10 pc(s). | |

Base



Relay base for RIDERSERIES RCM relays

- 2, 3 and 4 CO contacts
- Screw and PUSH IN wire connection
- Standard and low heights

General ordering data

| | | |
|------------|----------------------------|---|
| Type | SCM-I 2CO P | Version |
| Order No. | 8876220000 | RIDERSERIES RCM, Relay bases, Number of contacts: 2 CO contact, |
| GTIN (EAN) | 4032248609031 | Continuous current: 12 A, PUSH IN |
| Qty. | 10 pc(s). | |

RIDERSERIES RCM RCM270R12

Weidmüller Interface GmbH & Co. KG
 Klingenbergstraße 26
 D-32758 Detmold
 Germany
 Fon: +49 5231 14-0
 Fax: +49 5231 14-292083
 www.weidmueller.com

Accessories

| | | |
|------------|----------------------------|---|
| Type | SCM-I 4CO P | Version |
| Order No. | 8869430000 | RIDERSERIES RCM, Relay bases, Number of contacts: 4 CO contact, |
| GTIN (EAN) | 4032248614288 | Continuous current: 6 A, PUSH IN |
| Qty. | 10 pc(s). | |
| Type | SCM-I 4CO N | Version |
| Order No. | 8869390000 | RIDERSERIES RCM, Relay bases, Number of contacts: 4 CO contact, |
| GTIN (EAN) | 4032248614257 | Continuous current: 6 A, Screw connection |
| Qty. | 10 pc(s). | |
| Type | SCM-I 4CO | Version |
| Order No. | 8869420000 | RIDERSERIES RCM, Relay bases, Number of contacts: 4 CO contact, |
| GTIN (EAN) | 4032248614271 | Continuous current: 6 A, Screw connection |
| Qty. | 10 pc(s). | |
| Type | SCM-I 2CO | Version |
| Order No. | 8869400000 | RIDERSERIES RCM, Relay bases, Number of contacts: 2 CO contact, |
| GTIN (EAN) | 4032248614264 | Continuous current: 12 A, Screw connection |
| Qty. | 10 pc(s). | |

Metal retaining clip

Metal retaining clip for RIDERSERIES RCM relays



General ordering data

| | | |
|------------|----------------------------|---------------------------------|
| Type | SCM-I CLIP M | Version |
| Order No. | 8869450000 | RIDERSERIES RCM, Retaining clip |
| GTIN (EAN) | 4032248614301 | |
| Qty. | 10 pc(s). | |

Protection module



Pluggable protective modules for the RIDERSERIES RCI / RCM relay base, with optional protective functions.

- Optionally with free-wheel diode, load resistor or RC filter

General ordering data

| | | |
|------------|----------------------------|--|
| Type | RIM-I 1 6/230V | Version |
| Order No. | 8869580000 | RIDERSERIES, Free-wheeling diode, Rated control voltage: 6...230 V |
| GTIN (EAN) | 4032248614523 | DC, Plug-in connection |
| Qty. | 10 pc(s). | |

Creation date May 1, 2020 7:07:56 AM CEST

Data sheet

RIDERSERIES RCM RCM270R12

Weidmüller Interface GmbH & Co. KG
 Klingenbergstraße 26
 D-32758 Detmold
 Germany
 Fon: +49 5231 14-0
 Fax: +49 5231 14-292083
 www.weidmueller.com

Accessories

| | | | |
|------------|----------------------------|---|--|
| Type | RIM-I 3 6/60VAC RC | Version | |
| Order No. | 8869770000 | RIDERSERIES, RC filter, Rated control voltage: 6...60 V UC, Plug-in | |
| GTIN (EAN) | 4032248606320 | connection | |
| Qty. | 10 pc(s). | | |

Label (cannot be printed using PrintJet)



Weidmüller RIDERSERIES relays guarantee a noise-free, decoupled signal transmission in industrial automation concepts.

They are compact, quickly installed and can be fitted in the tightest of spaces.

- 2, 3 or 4 CO contacts
- optionally: AC or DC coils
- Relay with test button and integrated status display and/or free-wheel diode
- Optionally with hard gold plated 4 CO contacts
- pluggable LED modules with protective functions
- Metal and plastic retaining clips
- Base with screw / PUSH IN connection

General ordering data

| | | | |
|------------|----------------------------|------------------------|--|
| Type | SCM-I MARK | Version | |
| Order No. | 8869460000 | RIDERSERIES RCM, Label | |
| GTIN (EAN) | 4032248614417 | | |
| Qty. | 10 pc(s). | | |

**RIDERSERIES RCM
RCM270R12**

Weidmüller Interface GmbH & Co. KG
 Klingenbergstraße 26
 D-32758 Detmold
 Germany
 Fon: +49 5231 14-0
 Fax: +49 5231 14-292083
 www.weidmueller.com

Drawings

Miscellaneous

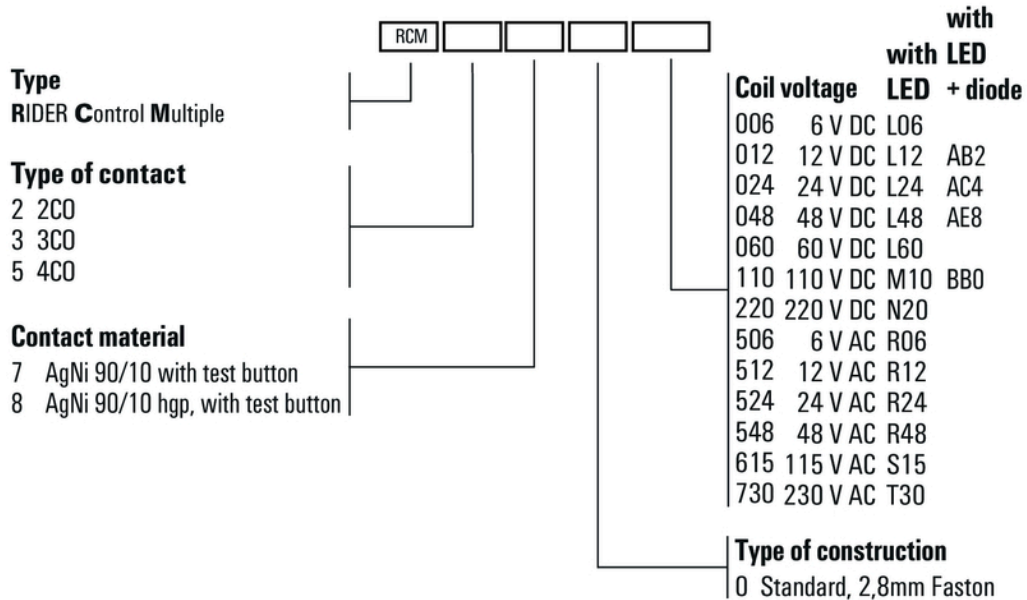

Type codes