

D-SERIES DRM DRM270730LT AU

Weidmüller Interface GmbH & Co. KG
 Klingenbergstraße 26
 D-32758 Detmold
 Germany
 Fon: +49 5231 14-0
 Fax: +49 5231 14-292083
 www.weidmueller.com

Product image



Similar to illustration

Relay from the D-SERIES DRM.

- 2 or 4 CO contacts
- Compact design
- Wide range of coil voltages
- Optional test button (AC red, DC blue)
- Optional with integrated status display (AC red, DC green)
and/or free-wheel diode

General ordering data

Type	DRM270730LT AU
Order No.	7760056186
Version	D-SERIES DRM, Relay, Number of contacts: 2, CO contact with test button, AgNi 5µm Au, Rated control voltage: 230 V AC, Continuous current: 10 A, Plug-in connection
GTIN (EAN)	4032248922253
Qty.	20 pc(s).

Creation date May 1, 2020 2:30:34 PM CEST

Catalogue status 17.04.2020 / We reserve the right to make technical changes.

D-SERIES DRM
DRM270730LT AU

Weidmüller Interface GmbH & Co. KG
 Klingenbergstraße 26
 D-32758 Detmold
 Germany
 Fon: +49 5231 14-0
 Fax: +49 5231 14-292083
 www.weidmueller.com

Technical data**Dimensions and weights**

Width	21 mm	Width (inches)	0.827 inch
Height	27.4 mm	Height (inches)	1.079 inch
Depth	35.7 mm	Depth (inches)	1.406 inch
Net weight	35 g		

Temperatures

Humidity	35...85 % rel. humidity, no condensation	Operating temperature, max.	55 °C
Operating temperature, min.	-40 °C	Storage temperature, max.	70 °C
Storage temperature, min.	-40 °C	Operating temperature	-40 °C...55 °C
Storage temperature	-40 °C...70 °C		

Environmental Product Compliance

REACH SVHC	Lead 7439-92-1
------------	----------------

Input

Rated control voltage	230 V AC	Rated current AC	6.1 mA (50 Hz), 5.2 mA (60 Hz)
Power rating	1.0...1.2VA (60HZ)	Pull-in/drop-out voltage, typ.	184 V / 69 V AC
Coil resistance	16000 Ω ± 10 %	Status indicator	red LED

Output

Rated switching voltage	250 V AC	Max. switching voltage, AC	250 V
Continuous current	10 A	Inrush current	20 A / 50 ms
AC switching capacity (resistive), max.	2500 VA	DC switching capacity (resistive), max.	240 W @ 24 V
Switch-on delay	< 20 ms	Switch-off delay	< 20 ms
Min. switching power	1 mA @ 1 V	Max. switching frequency at rated load	0.1 Hz

Contact data

Contact type	2 CO contact with test button (AgNi 5µm Au)	Contact resistance	≤ 50 mΩ
Mechanical service life	20 x 10 ⁶ switching cycles		

General data

Test button	yes (lockable)	Mechanical switch position indicator	Yes
Colour	Transparent	UL 94 flammability rating	V-2

Insulation coordination

Rated voltage	250 V	Surge voltage category	III
Pollution severity	2	Protection degree	IP20
Dielectric strength, Input/Output	1.8 kV _{eff} / 1 min.	Creepage and clearance distance input - output	≥ 5.5 mm
Dielectric strength of neighbouring contacts	1 kV _{eff} / 1 min	Dielectric strength of open contact	1 kV _{eff} / 1 min
Impulse withstand voltage	6 kV (1.2/50 µs)		

Data sheet

**D-SERIES DRM
DRM270730LT AU**

Weidmüller Interface GmbH & Co. KG
Klingenbergstraße 26
D-32758 Detmold
Germany
Fon: +49 5231 14-0
Fax: +49 5231 14-292083
www.weidmueller.com

Technical data

Further details of approvals / standards

Standards	IEC 61810-1, EN 60664-1:2007, EN 61000-6-2:2005, EN 61000-6-4:2007 + A1:2011
-----------	--

Connection data

Wire connection method	Plug-in connection
------------------------	--------------------

Classifications

ETIM 6.0	EC001437	ETIM 7.0	EC001437
eClass 9.0	27-37-16-01	eClass 9.1	27-37-16-01
eClass 10.0	27-37-16-01		

Approvals

Approvals



ROHS	Conform
------	---------

Downloads

Approval/Certificate/Document of Conformity	EU Konformitätserklärung / EU Declaration of Conformity
Engineering Data	EPLAN_WSCAD
Engineering Data	STEP

**D-SERIES DRM
DRM270730LT AU**

Weidmüller Interface GmbH & Co. KG
 Klingenbergstraße 26
 D-32758 Detmold
 Germany
 Fon: +49 5231 14-0
 Fax: +49 5231 14-292083
 www.weidmueller.com

Drawings

Wiring diagram

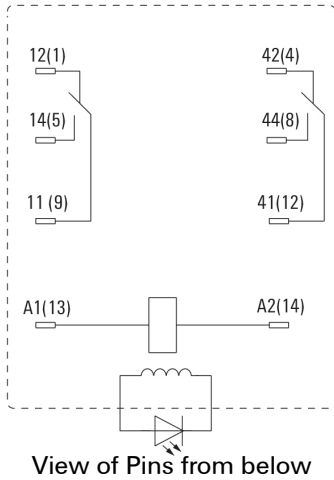

Graph

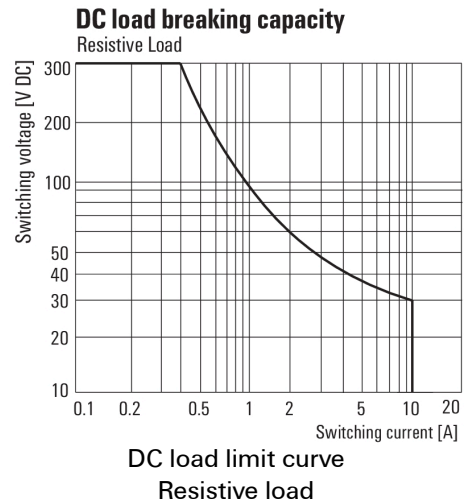

Graph

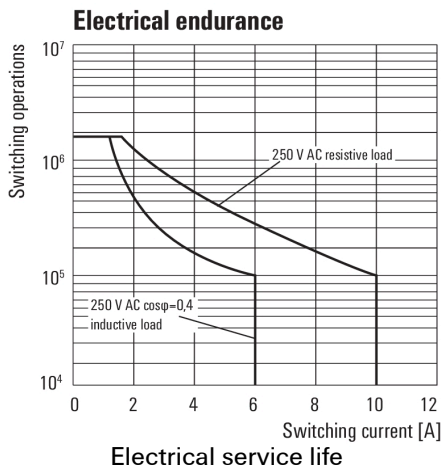

Graph

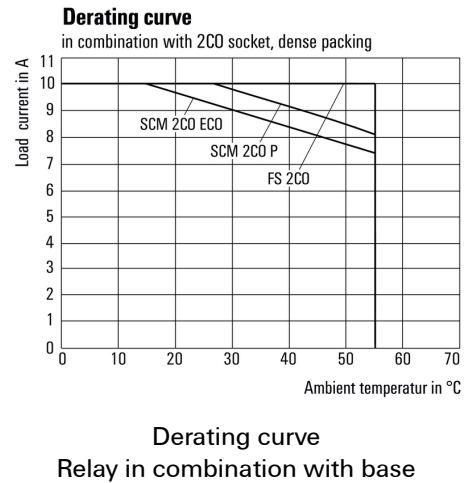

Graph

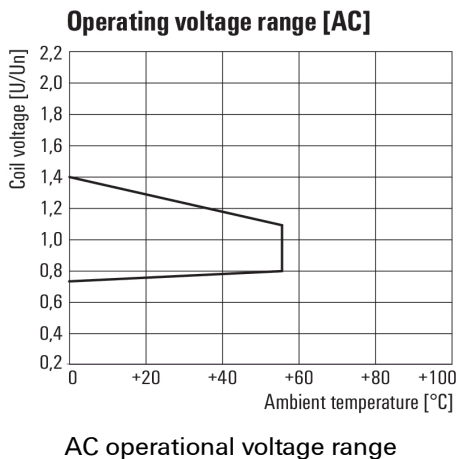

Dimensional drawing

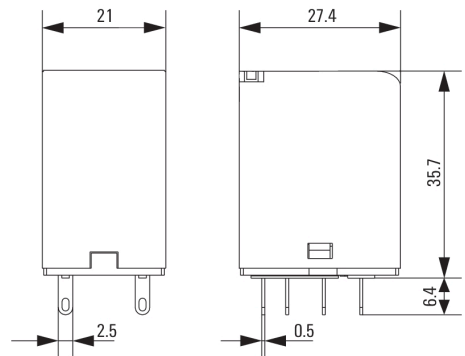

D-SERIES DRM DRM270730LT AU

Weidmüller Interface GmbH & Co. KG
 Klingenbergstraße 26
 D-32758 Detmold
 Germany
 Fon: +49 5231 14-0
 Fax: +49 5231 14-292083
 www.weidmueller.com

Mating connector (fully pluggable)

Base



Accessories for D-SERIES relays include:

- Relay bases
- LED / Protective modules
- Metal retaining clips

General ordering data

Type	SCM 4CO P	Version
Order No.	7760056363	D-SERIES DRM, Relay bases, Number of contacts: 4 CO contact,
GTIN (EAN)	6944169772276	Continuous current: 6 A, PUSH IN
Qty.	10 pc(s).	
Type	FS 4CO	Version
Order No.	7760056107	D-SERIES DRM, Relay bases, Number of contacts: 4, CO contact,
GTIN (EAN)	4032248855575	Continuous current: 10 A, Screw connection
Qty.	10 pc(s).	
Type	FS 2CO	Version
Order No.	7760056106	D-SERIES DRM, Relay bases, Number of contacts: 2, CO contact,
GTIN (EAN)	4032248855582	Continuous current: 12 A, Screw connection
Qty.	10 pc(s).	
Type	SCM 2CO ECO	Version
Order No.	7760056263	D-SERIES DRM, Relay bases, Number of contacts: 2 CO contact,
GTIN (EAN)	6944169662966	Continuous current: 12 A, Screw connection
Qty.	10 pc(s).	
Type	SCM 2CO P	Version
Order No.	7760056362	D-SERIES DRM, Relay bases, Number of contacts: 2 CO contact,
GTIN (EAN)	6944169772269	Continuous current: 12 A, PUSH IN
Qty.	10 pc(s).	
Type	SCM 4CO ECO	Version
Order No.	7760056264	D-SERIES DRM, Relay bases, Number of contacts: 4 CO contact,
GTIN (EAN)	6944169662973	Continuous current: 6 A, Screw connection
Qty.	10 pc(s).	

D-SERIES DRM DRM270730LT AU

Weidmüller Interface GmbH & Co. KG
 Klingenbergstraße 26
 D-32758 Detmold
 Germany
 Fon: +49 5231 14-0
 Fax: +49 5231 14-292083
 www.weidmueller.com

Accessories

Blank



ESG is the tried-and-tested marker in MultiCard format for use on many well-known electrical devices. The result is high-quality device marking with a high-contrast appearance.

Various types are available for devices from the following manufacturers:

- Siemens
- Télémecanique
- ABB
- Beckhoff
- Lumberg
- Tags for all-purpose usage; self-adhesive or clip-on tags, depending on the type

Advantages at a glance:

- Tags for universal usage, self-adhesive or clip-on tags, depending on type
- For aligned equipment, e.g. circuit breakers, we supply ESG markers for clipping onto tag rails
- Individual laser-quality printing according to specifications

For custom printing: Please send us a file of our labeling software M-Print PRO or M-Print PRO Online (without installation) for your labeling specifications.

Please note that these markers are not intended for printing with the SpeedMarking laser.

General ordering data

Type	ESG 6/17 K MC NE WS	Version
Order No.	1880120000	ESG, Device markers x 17 mm, PA 66, Colour: white, Self-adhesive
GTIN (EAN)	4032248478804	
Qty.	200 pc(s).	
Type	ESG 6/17 K MC NE GE	Version
Order No.	1880110000	ESG, Device markers x 17 mm, PA 66, Colour: yellow, Self-adhesive
GTIN (EAN)	4032248478798	
Qty.	200 pc(s).	

D-SERIES DRM DRM270730LT AU

Weidmüller Interface GmbH & Co. KG
 Klingenbergstraße 26
 D-32758 Detmold
 Germany
 Fon: +49 5231 14-0
 Fax: +49 5231 14-292083
 www.weidmueller.com

Accessories

Base



Accessories for D-SERIES relays include:

- Relay bases
- LED / Protective modules
- Metal retaining clips

General ordering data

Type	SCM 4CO P	Version
Order No.	7760056363	D-SERIES DRM, Relay bases, Number of contacts: 4 CO contact,
GTIN (EAN)	6944169772276	Continuous current: 6 A, PUSH IN
Qty.	10 pc(s).	
Type	FS 4CO	Version
Order No.	7760056107	D-SERIES DRM, Relay bases, Number of contacts: 4, CO contact,
GTIN (EAN)	4032248855575	Continuous current: 10 A, Screw connection
Qty.	10 pc(s).	
Type	FS 2CO	Version
Order No.	7760056106	D-SERIES DRM, Relay bases, Number of contacts: 2, CO contact,
GTIN (EAN)	4032248855582	Continuous current: 12 A, Screw connection
Qty.	10 pc(s).	
Type	SCM 2CO ECO	Version
Order No.	7760056263	D-SERIES DRM, Relay bases, Number of contacts: 2 CO contact,
GTIN (EAN)	6944169662966	Continuous current: 12 A, Screw connection
Qty.	10 pc(s).	
Type	SCM 2CO P	Version
Order No.	7760056362	D-SERIES DRM, Relay bases, Number of contacts: 2 CO contact,
GTIN (EAN)	6944169772269	Continuous current: 12 A, PUSH IN
Qty.	10 pc(s).	
Type	SCM 4CO ECO	Version
Order No.	7760056264	D-SERIES DRM, Relay bases, Number of contacts: 4 CO contact,
GTIN (EAN)	6944169662973	Continuous current: 6 A, Screw connection
Qty.	10 pc(s).	

**D-SERIES DRM
DRM270730LT AU**

Weidmüller Interface GmbH & Co. KG
Klingenbergstraße 26
D-32758 Detmold
Germany
Fon: +49 5231 14-0
Fax: +49 5231 14-292083
www.weidmueller.com

Accessories

Blank



ESG is the tried-and-tested marker in MultiCard format for use on many well-known electrical devices. The result is high-quality device marking with a high-contrast appearance.

Various types are available for devices from the following manufacturers:

- Siemens
- Télémecanique
- ABB
- Beckhoff
- Lumberg
- Tags for all-purpose usage; self-adhesive or clip-on tags, depending on the type

Advantages at a glance:

- Tags for universal usage, self-adhesive or clip-on tags, depending on type
- For aligned equipment, e.g. circuit breakers, we supply ESG markers for clipping onto tag rails
- Individual laser-quality printing according to specifications

For custom printing: Please send us a file of our labeling software M-Print PRO or M-Print PRO Online (without installation) for your labeling specifications.

Please note that these markers are not intended for printing with the SpeedMarking laser.

General ordering data

Type	ESG 6/15 K MC NE WS	Version
Order No.	1880100000	ESG, Device markers x 15 mm, PA 66, Colour: white, Self-adhesive
GTIN (EAN)	4032248478781	
Qty.	200 pc(s).	
Type	ESG 6/15 K MC NE GE	Version
Order No.	1880130000	ESG, Device markers x 15 mm, PA 66, Colour: yellow, Self-adhesive
GTIN (EAN)	4032248478910	
Qty.	200 pc(s).	

**D-SERIES DRM
DRM270730LT AU**

Weidmüller Interface GmbH & Co. KG
Klingenbergstraße 26
D-32758 Detmold
Germany
Fon: +49 5231 14-0
Fax: +49 5231 14-292083
www.weidmueller.com

Accessories

Retaining clip



Accessories for D-SERIES relays include:

- Relay bases
- LED / Protective modules
- Metal retaining clips

General ordering data

Type	SCM CLIP P	Version
Order No.	7760056367	D-SERIES DRM, Retaining clip
GTIN (EAN)	6944169773334	
Qty.	5 pc(s).	
Type	DRM/DRL CLIP M	Version
Order No.	7760056108	D-SERIES, Retaining clip
GTIN (EAN)	4032248855568	
Qty.	20 pc(s).	

Protection modules



Accessories for D-SERIES relays include:

- Relay bases
- LED / Protective modules
- Metal retaining clips

General ordering data

Type	RIM 3 110/230VAC	Version
Order No.	7760056014	D-SERIES, RC filter, Rated control voltage: 110...230 V AC, Plug-in connection
GTIN (EAN)	4032248878109	
Qty.	10 pc(s).	
Type	RIM 3 110/230VAC LED	Version
Order No.	7760056045	D-SERIES, RC filter, Rated control voltage: 110...230 V AC, Plug-in connection
GTIN (EAN)	4032248878147	
Qty.	10 pc(s).	

**D-SERIES DRM
DRM270730LT AU**

Weidmüller Interface GmbH & Co. KG
 Klingenbergstraße 26
 D-32758 Detmold
 Germany
 Fon: +49 5231 14-0
 Fax: +49 5231 14-292083
 www.weidmueller.com

Accessories**LED**

Accessories for D-SERIES relays include:

- Relay bases
- LED / Protective modules
- Metal retaining clips

General ordering data

Type	RIM 3 110/230VUC	Version
Order No.	7940018455	D-SERIES, LED module, Rated control voltage: 110...230 V UC, Plug-in connection
GTIN (EAN)	4032248878185	
Qty.	20 pc(s).	

MultiCard

The Weidmüller device markers enable users to conform to obligatory equipment labelling regulations. Users can label the device markers themselves by means of suitable software and system-compatible printer systems. ESG is the tried-and-tested marker in MultiCard format. The result is high-quality device marking with a high-contrast appearance.

ESG 9/26 SCM ECO MC... for marking D-SERIES DRM relay sockets:

- Attachable MultiCard markers
- Depending on the relay socket it is attachable on up to 4 levels
- Additional option for attaching the marker on plastic retaining clip: SCM CLIP P
- PrintJet printable

General ordering data

Type	ESG 9/26 SCM ECO MC NE ...	Version
Order No.	1520990000	ESG, Device markers x 26 mm, PA 66, Colour: yellow
GTIN (EAN)	4050118327861	
Qty.	80 pc(s).	
Type	ESG 9/26 SCM ECO MC SDR	Version
Order No.	1525800000	ESG, Device markers x 26 mm, PA 66, Colour: To customer specification
GTIN (EAN)	4050118331875	
Qty.	80 pc(s).	
Type	ESG 9/26 SCM ECO MC NE ...	Version
Order No.	1521000000	ESG, Device markers x 26 mm, PA 66, Colour: grey
GTIN (EAN)	4050118327878	
Qty.	80 pc(s).	

Data sheet**D-SERIES DRM
DRM270730LT AU**

Weidmüller Interface GmbH & Co. KG
Klingenbergstraße 26
D-32758 Detmold
Germany
Fon: +49 5231 14-0
Fax: +49 5231 14-292083
www.weidmueller.com

Accessories

Type	ESG 9/26 SCM ECO MC NE ...	Version
Order No.	1520980000	ESG, Device markers x 26 mm, PA 66, Colour: white
GTIN (EAN)	4050118327939	
Qty.	80 pc(s).	

Data sheet

**D-SERIES DRM
DRM270730LT AU**

Weidmüller Interface GmbH & Co. KG
 Klingenbergstraße 26
 D-32758 Detmold
 Germany
 Fon: +49 5231 14-0
 Fax: +49 5231 14-292083
 www.weidmueller.com

Drawings

Miscellaneous

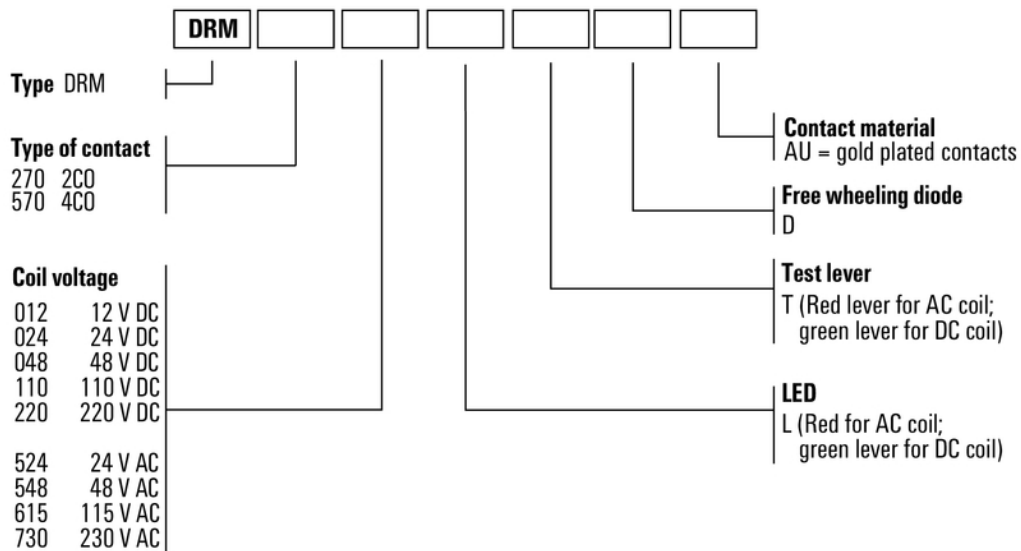

Type codes