

D-SERIES DRI DRIKITP230VAC 2CO LD/PB

Weidmüller Interface GmbH & Co. KG
 Klingenbergstraße 26
 D-32758 Detmold
 Germany
 Fon: +49 5231 14-0
 Fax: +49 5231 14-292083
 www.weidmueller.com

Product image

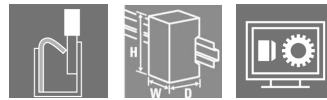

Similar to illustration

Our relay kits are particularly convenient to use. The kits are delivered fully assembled and 100 % function-tested. This saves assembly time and reduces the number of parts required.

- Assembled kit consisting of relay, base and retaining clip, incl. label
- 100% function-tested
- 100% control of the dielectric strength input - output
- Optional: test button with coloured control voltage marking (AC coil: red / DC coil: blue) and mechanical switch position indicator
- Bright status LED (AC coil: red / DC coil: green)

General ordering data

Type	DRIKITP230VAC 2CO LD/PB
Order No.	2576 150000
Version	D-SERIES DRI, Relay module, Number of contacts: 2 CO contact with test button AgSnO, Rated control voltage: 230 V AC, Continuous current: 5 A, PUSH IN with actuator
GTIN (EAN)	4050118585919
Qty.	10 pc(s).

Creation date May 2, 2020 3:13:07 AM CEST

D-SERIES DRI
DRIKITP230VAC 2CO LD/PB

Weidmüller Interface GmbH & Co. KG
 Klingenbergstraße 26
 D-32758 Detmold
 Germany
 Fon: +49 5231 14-0
 Fax: +49 5231 14-292083
 www.weidmueller.com

Technical data
Dimensions and weights

Width	15.9 mm	Width (inches)	0.626 inch
Height	102.1 mm	Height (inches)	4.02 inch
Depth	63 mm	Depth (inches)	2.48 inch
Net weight	59.97 g		

Temperatures

Humidity	35...85 % rel. humidity, no condensation	Operating temperature, max.	55 °C
Operating temperature, min.	-40 °C	Storage temperature, max.	85 °C
Storage temperature, min.	-40 °C	Operating temperature	-40 °C...85 °C
Storage temperature	-40 °C...85 °C		

Environmental Product Compliance

REACH SVHC Lead 7439-92-1

Input

Rated control voltage	230 V AC	Rated current AC	4,9 mA
Power rating	1.1 VA	Pull-in/drop-out voltage, typ.	184 V / 69 V AC
Coil resistance	23500 Ω ± 10 %	Status indicator	red LED

Output

Rated switching voltage	250 V AC	Max. switching voltage, AC	250 V
Max. switching voltage, DC	250 V	Continuous current	5 A
AC switching capacity (resistive), max.	1250 VA	DC switching capacity (resistive), max.	150 W @ 24 V
Switch-on delay	≤ 15 ms	Switch-off delay	≤ 10 ms
Min. switching power	10 mA @ 12 V, 100 mA @ 5 V	Max. switching frequency at rated load	0.1 Hz

Contact data

Contact type	2 CO contact with test button (AgSnO)	Mechanical service life	10 x 10 ⁶ switching cycles
--------------	---------------------------------------	-------------------------	---------------------------------------

General data

Rail	TS 35	Test button	yes (lockable)
Mechanical switch position indicator	Yes	Colour	black

Insulation coordination

Rated voltage	250 V	Surge voltage category	III
Pollution severity	2	Insulating material group	IIIb
Protection degree	IP20	Dielectric strength, Input/Output	5 kV _{eff} / 1 min
Creepage and clearance distance input - output	≥ 3 mm	Dielectric strength of neighbouring contacts	1.5 kV _{eff} / 1 min.
Impulse withstand voltage at neighbouring contacts	4.8 kV (1.2/50 μs)	Dielectric strength of open contact	1 kV _{eff} / 1 min
Impulse withstand voltage	5 kV (1.2/50 μs)		

**D-SERIES DRI
DRIKITP230VAC 2CO LD/PB**

Weidmüller Interface GmbH & Co. KG
 Klingenbergstraße 26
 D-32758 Detmold
 Germany
 Fon: +49 5231 14-0
 Fax: +49 5231 14-292083
 www.weidmueller.com

Technical data**Further details of approvals / standards**

Standards	IEC 61810-1, EN 60664-1:2007, EN 61000-6-2:2005, EN 61000-6-4:2007 + A1:2011	Certificate no. (cURus) relay	E312083
Certificate no. (cURus) base	E312083		

Connection data

Wire connection method	PUSH IN with actuator	Stripping length, rated connection	10 mm
Clamping range, rated connection	1.5 mm ²	Clamping range, min.	0.14 mm ²
Clamping range, max.	1.5 mm ²	Wire connection cross section AWG, min.	AWG 26
Wire connection cross section AWG, max.	AWG 16	Wire cross-section, solid, min.	0.14 mm ²
Wire cross-section, solid, max.	1.5 mm ²	Wire connection cross-section, finely stranded, min.	0.14 mm ²
Wire connection cross section, finely stranded, max.	1.5 mm ²	Wire connection cross-section, finely stranded with wire-end ferrules DIN 46228/4, min.	0.14 mm ²
Wire connection cross-section, finely stranded with wire-end ferrules DIN 46228/4, max.	1 mm ²	Conductor cross-section, flexible, AEH (DIN 46228-1), min.	0.14 mm ²
Conductor cross-section, flexible, AEH (DIN 46228-1), max.	1.5 mm ²	Blade size	0.4 x 2.5 mm

Classifications

ETIM 6.0	EC001437	ETIM 7.0	EC001437
eClass 9.0	27-37-16-01	eClass 9.1	27-37-16-01
eClass 10.0	27-37-16-01		

Approvals

Approvals

**Downloads**

Approval/Certificate/Document of Conformity	EU Konformitätserklärung / EU Declaration of Conformity
Engineering Data	EPLAN
Engineering Data	STEP

**D-SERIES DRI
DRIKITP230VAC 2CO LD/PB**

Weidmüller Interface GmbH & Co. KG
 Klingenbergstraße 26
 D-32758 Detmold
 Germany
 Fon: +49 5231 14-0
 Fax: +49 5231 14-292083
 www.weidmueller.com

Drawings

Wiring diagram

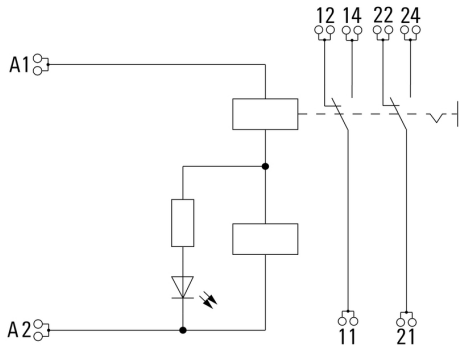

Graph

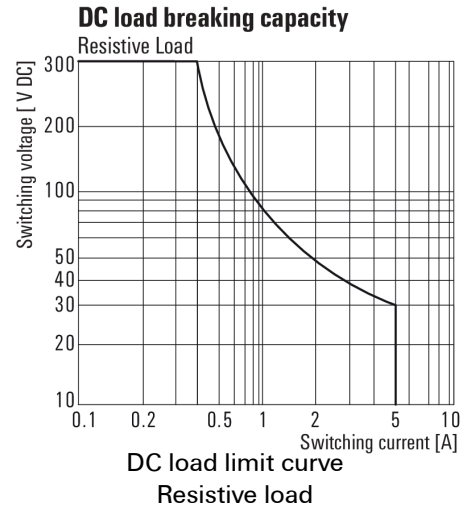

Graph

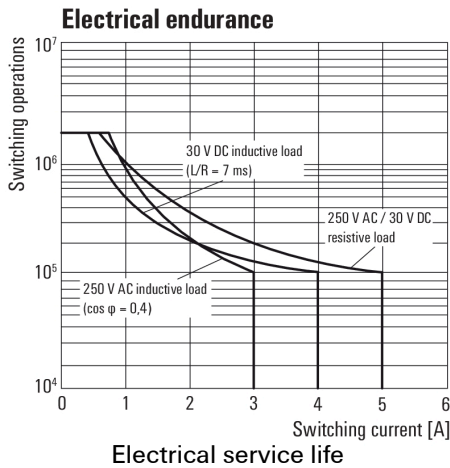

Graph

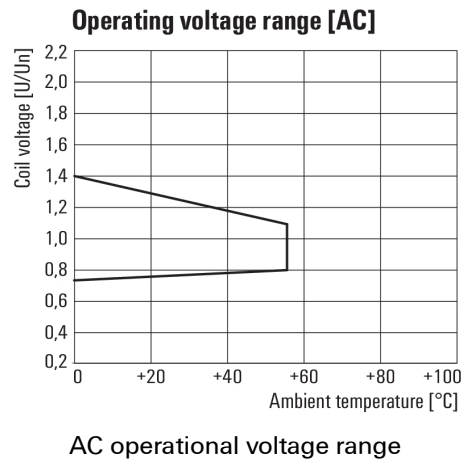

Dimensional drawing

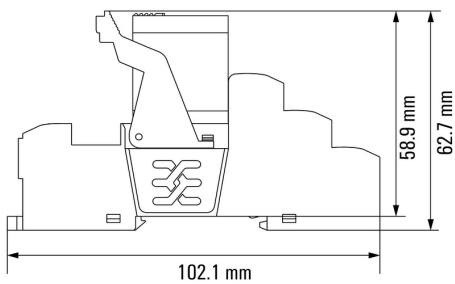

Relay in combination with base

**D-SERIES DRI
DRIKITP230VAC 2CO LD/PB**

Weidmüller Interface GmbH & Co. KG
 Klingenbergstraße 26
 D-32758 Detmold
 Germany
 Fon: +49 5231 14-0
 Fax: +49 5231 14-292083
 www.weidmueller.com

Accessories

Cross-connection for base with PUSH IN connection

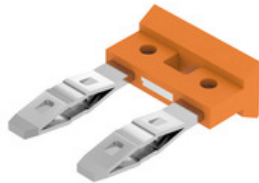

In an industrial environment, service work needs to be carried out quickly, simply and reliably. If components are replaced, bended relay contacts often cause errors which are difficult to locate.

As the handling of components in practice plays an increasingly important role, DRI relays have particularly stable plug contacts for quick and safe mounting. The test button with latching in end position can be operated tool-free. An easily visible, LED illuminated status display also allows clear determination of status.

Both during installation of the cabinet and during subsequent servicing in the machinery and plant engineering sector, DRI relays are the optimum coupling element for confined installation conditions.

General ordering data

Type	SCM/SDI P CC	Version
Order No.	7760056366	D-SERIES, Cross-connector
GTIN (EAN)	6944169773327	
Qty.	10 pc(s).	

LED



Accessories for D-SERIES relays include:

- Relay bases
- LED / Protective modules
- Metal retaining clips

General ordering data

Type	RIM 3 110/230VUC	Version
Order No.	7940018455	D-SERIES, LED module, Rated control voltage: 110...230 V UC, Plug-in connection
GTIN (EAN)	4032248878185	
Qty.	20 pc(s).	

D-SERIES DRI DRIKITP230VAC 2CO LD/PB

Weidmüller Interface GmbH & Co. KG
 Klingenbergstraße 26
 D-32758 Detmold
 Germany
 Fon: +49 5231 14-0
 Fax: +49 5231 14-292083
 www.weidmueller.com

Accessories

MultiCard



The Weidmüller device markers enable users to conform to obligatory equipment labelling regulations. Users can label the device markers themselves by means of suitable software and system-compatible printer systems. ESG is the tried-and-tested marker in MultiCard format. The result is high-quality device marking with a high-contrast appearance.

ESG 6/15 SDI MC... for marking D-SERIES DRI relay sockets:

- Attachable MultiCard markers
- Depending on the relay socket it is attachable on up to 4 levels
- Additional option for attaching the marker on plastic retaining clip: SDI CLIP P
- PrintJet printable

General ordering data

Type	ESG 6/15 SDI MC NE WS	Version
Order No.	2558340000	ESG, Device markers x 15 mm, PA 66, Colour: white
GTIN (EAN)	4050118569056	
Qty.	200 pc(s).	

Type	ESG 6/15 SDI MC SDR	Version
Order No.	2558310000	ESG, Device markers x 15 mm, PA 66, Colour: To customer specification
GTIN (EAN)	4050118569025	
Qty.	40 pc(s).	

Protection modules



Accessories for D-SERIES relays include:

- Relay bases
- LED / Protective modules
- Metal retaining clips

General ordering data

Type	RIM 3 110/230VAC	Version
Order No.	7760056014	D-SERIES, RC filter, Rated control voltage: 110...230 V AC, Plug-in connection
GTIN (EAN)	4032248878109	
Qty.	10 pc(s).	

Data sheet

**D-SERIES DRI
DRIKITP230VAC 2CO LD/PB**

Weidmüller Interface GmbH & Co. KG
 Klingenbergstraße 26
 D-32758 Detmold
 Germany
 Fon: +49 5231 14-0
 Fax: +49 5231 14-292083
 www.weidmueller.com

Accessories

Slotted screwdriver

Slotted screwdriver with rounded blade SD DIN 5265, ISO 2380/2, output to DIN 5264, ISO 2380/1. ChromTop tip, SoftFinish grip



General ordering data

Type	SDS 0.4X2.5X75	Version
Order No.	9009030000	Screwdriver, Blade width (B): 2.5 mm, Blade length: 75 mm, Blade thickness (A): 0.4 mm
GTIN (EAN)	4032248266944	
Qty.	1 pc(s).	

Retaining clip

Accessories for D-SERIES relays include:

- Relay bases
- LED / Protective modules
- Metal retaining clips



General ordering data

Type	SDI CLIP HM	Version
Order No.	7760056390	D-SERIES DRI, Retaining clip
GTIN (EAN)	6944169787898	
Qty.	10 pc(s).	

Data sheet**D-SERIES DRI
DRIKITP230VAC 2CO LD/PB**

Weidmüller Interface GmbH & Co. KG
Klingenbergstraße 26
D-32758 Detmold
Germany
Fon: +49 5231 14-0
Fax: +49 5231 14-292083
www.weidmueller.com

Accessories**Slotted screwdriver**

VDE insulated slot-head screwdriver, SDI DIN 7437, ISO 2380/2, drive output acc. to DIN 5264, ISO 2380/1. SoftFinish grip

**General ordering data**

Type	SDIS 0.4X2.5X75	Version
Order No.	9008370000	Screwdriver, Blade width (B): 2.5 mm, Blade length: 75 mm, Blade
GTIN (EAN)	4032248056330	thickness (A): 0.4 mm
Qty.	1 pc(s).	

