

**OMNIMATE Power - series BV/SV 7.62HP
SV-SMT 7.62HP/04/270G SC/4 2.6SN BX**

Weidmüller Interface GmbH & Co. KG
Klingenbergstraße 26
D-32758 Detmold
Germany
Fon: +49 5231 14-0
Fax: +49 5231 14-292083
www.weidmueller.com



OMNIMATE Power BV / SV 7.62HP Hybrid – for power, signals and EMC

Three functions in one!

The OMNIMATE Power Hybrid connector provides developers and users with the perfect three-in-one solution.

This hybrid motor connector simultaneously unites power, signals and pluggable EMC shield support. Thus you save space on the PCB, on the outer side of the housing, and in the electrical cabinet. The self-snapping one-handed interlock mechanism requires only one plugging step and thus speeds up installation and maintenance procedures. It is easy to handle and interlocks automatically – even in difficult installation positions. The unique shielding shape and slender 30° wire entry enable a space savings of up to 10 cm between rows.

General ordering data

Type	SV-SMT 7.62HP/04/270G SC/4 2.6SN BX
Order No.	2529310000
Version	PCB plug-in connector, male header, closed side, THT/THR solder connection, 7.62 mm, Number of poles: 4, Solder pin length (l): 2.6 mm, tinned, black, Box
GTIN (EAN)	4050118539387
Qty.	48 pc(s).
Product data	IEC: 1000 V / 41 A UL: 300 V / 33 A
Packaging	Box

**OMNIMATE Power - series BV/SV 7.62HP
SV-SMT 7.62HP/04/270G SC/4 2.6SN BX**

Weidmüller Interface GmbH & Co. KG
 Klingenbergstraße 26
 D-32758 Detmold
 Germany
 Fon: +49 5231 14-0
 Fax: +49 5231 14-292083
 www.weidmueller.com

Technical data**Dimensions and weights**

Height of lowest version	11.4 mm	Depth	28.3 mm
Depth (inches)	1.114 inch	Net weight	6.68 g

System specifications

Product family	OMNIMATE Power - series BV/SV 7.62HP	Type of connection	Board connection
Mounting onto the PCB	THT/THR solder connection	Pitch in mm (P)	7.62 mm
Pitch in inches (P)	0.3 inch	Number of poles	4
Number of solder pins per pole	2	Solder pin length (l)	2.6 mm
Solder pin dimensions	0.8 x 1.0 mm	Solder eyelet hole diameter (D)	1.4 mm
Solder eyelet hole diameter tolerance (D)+	0, 1 mm	L1 in mm	22.86 mm
L1 in inches	0.9 inch	Pin series quantity	1
Touch-safe protection acc. to DIN VDE 57 106	safe to back of hand above the printed circuit board	Touch-safe protection acc. to DIN VDE 0470	IP 20
Volume resistance	2.00 mΩ	Can be coded	Yes
Plugging cycles	25	Plugging force/pole, max.	12 N
Pulling force/pole, max.	7 N		

Material data

Insulating material	PA GF HT3	Colour	black
Colour chart (similar)	RAL 9011	Insulating material group	I
Comparative Tracking Index (CTI)	≥ 600	Insulation strength	≥ 10 ⁸ Ω
Moisture Level (MSL)	3	UL 94 flammability rating	V-0
Contact material	Copper alloy	Contact surface	tinned
Layer structure of solder connection	1-3 μm Ni / 4-6 μm Sn matt	Layer structure of plug contact	1-3 μm Ni / 4-6 μm Sn matt
Storage temperature, min.	-25 °C	Storage temperature, max.	50 °C
Max. relative humidity during storage	70 %	Operating temperature, min.	-50 °C
Operating temperature, max.	130 °C	Temperature range, installation, min.	-25 °C
Temperature range, installation, max.	130 °C		

Rated data acc. to IEC

tested acc. to standard	IEC 60664-1, IEC 61984	Rated current, min. number of poles (Tu=20°C)	41 A
Rated current, max. number of poles (Tu=20°C)	41 A	Rated current, min. number of poles (Tu=40°C)	41 A
Rated current, max. number of poles (Tu=40°C)	41 A	Rated voltage for surge voltage class / pollution degree II/2	1,000 V
Rated voltage for surge voltage class / pollution degree III/2	630 V	Rated voltage for surge voltage class / pollution degree III/3	630 V
Rated impulse voltage for surge voltage class/ pollution degree II/2	6 kV	Rated impulse voltage for surge voltage class/ pollution degree III/2	6 kV
Rated impulse voltage for surge voltage class/ contamination degree III/3	6 kV	Short-time withstand current resistance	3 x 1s with 420 A

Rated data acc. to UL 1059

Rated voltage (Use group B / UL 1059)	300 V	Rated voltage (Use group C / UL 1059)	300 V
Rated voltage (Use group D / UL 1059)	600 V	Rated current (Use group B / UL 1059)	33 A
Rated current (Use group C / UL 1059)	33 A	Rated current (Use group D / UL 1059)	5 A
Clearance distance, min.	6.9 mm	Creepage distance, min.	9.6 mm

**OMNIMATE Power - series BV/SV 7.62HP
SV-SMT 7.62HP/04/270G SC/4 2.6SN BX**

Weidmüller Interface GmbH & Co. KG
Klingenbergstraße 26
D-32758 Detmold
Germany
Fon: +49 5231 14-0
Fax: +49 5231 14-292083
www.weidmueller.com

Technical data
Packing

Packaging	Box	VPE length	350 mm
VPE width	135 mm	VPE height	40 mm

Technical data - hybrid

Pitch in mm (Signal)	3.81 mm	Pitch in inches (Signal)	0.15 inch
Number of poles (Signal)	4	Number of solder pins per pole (Signal)	1
Solder pin dimensions (Signal)	0.8 x 0.8 mm	PCB hole diameter (Signal)	1.3 mm
PCB hole diameter tolerance (Signal)	± 0.1 mm	L2 in mm	3.81 mm
L2 in inch	0.15 inch	Number of rows (Signal)	2
Contact material (Signal)	CuMg	Contact surface (Signal)	tinned
Rated voltage for overvoltage class/ pollution severity level II/2 (Signal)	320 V	Rated voltage for overvoltage class/ pollution severity level III/2 (Signal)	160 V
Rated voltage for overvoltage class/ pollution severity level III/3 (Signal)	160 V	Rated impulse voltage for overvoltage class/pollution severity level II/2 (Signal)	2.5 kV
Rated impulse voltage for overvoltage class/pollution severity level III/2 (Signal)	2.5 kV	Rated impulse voltage for overvoltage class/pollution severity level III/3 (Signal)	2.5 kV
Short-time withstand current resistance (Signal)	3 x 1s with 80 A	Rated voltage (Use group B / CSA) (Signal)	300 V
Rated voltage (Use group C / CSA) (Signal)	50 V	Rated current (Use group B / CSA) (Signal)	9 A
Rated current (Use group C / CSA) (Signal)	9 A	Rated current (Use group D / CSA) (Signal)	9 A
Rated voltage (Use group B / UL 1059) (Signal)	300 V	Rated voltage (Use group C / UL 1059) (Signal)	50 V factory wiring
Rated voltage (Use group D / UL 1059) (Signal)	300 V	Rated current (Use group B / UL 1059) (Signal)	5 A
Rated current (Use group C / UL 1059) (Signal)	5 A		

Classifications

ETIM 6.0	EC002637	ETIM 7.0	EC002637
eClass 9.0	27-44-04-02	eClass 9.1	27-44-04-02
eClass 10.0	27-44-04-02		

Notes

Notes	<ul style="list-style-type: none"> • Technical specifications refer to the power contacts • Technical data of signal contacts: 50V / 5A, stripping length 8mm • Rated current related to rated cross-section & min. No. of poles. • Specifications of diagram: P1=7.62 mm; P2=3.81 mm • Rated data refer only to the component itself. Clearance and creepage distances to other components are to be designed in accordance with the relevant application standards.
IPC conformity	Conformity: The products are developed, manufactured and delivered according international recognized standards and norms and comply with the assured properties in the data sheet resp. fulfill decorative properties in accordance with IPC-A-610 "Class 2". Further claims on the products can be evaluated on request.

Data sheet**OMNIMATE Power - series BV/SV 7.62HP
SV-SMT 7.62HP/04/270G SC/4 2.6SN BX****Weidmüller Interface GmbH & Co. KG**
Klingenbergstraße 26
D-32758 Detmold
Germany
Fon: +49 5231 14-0
Fax: +49 5231 14-292083
www.weidmueller.com**Technical data****Downloads**White paper power electronics
connected correctly[Download Whitepaper](#)

White paper UL 600 V

[Download Whitepaper](#)

**OMNIMATE Power - series BV/SV 7.62HP
SV-SMT 7.62HP/04/270G SC/4 2.6SN BX**

Weidmüller Interface GmbH & Co. KG
Klingenbergstraße 26
D-32758 Detmold
Germany
Fon: +49 5231 14-0
Fax: +49 5231 14-292083
www.weidmueller.com

Drawings

Dimensional drawing

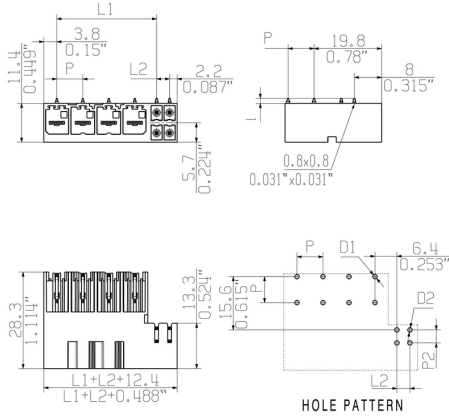

Data sheet

OMNIMATE Power - series BV/SV 7.62HP SV-SMT 7.62HP/04/270G SC/4 2.6SN BX

Weidmüller Interface GmbH & Co. KG
 Klingenbergstraße 26
 D-32758 Detmold
 Germany
 Fon: +49 5231 14-0
 Fax: +49 5231 14-292083
 www.weidmueller.com

Accessories

Coding elements



**Only connects what is supposed to be connected:
the right connection at the right place.**

Coding elements and locking devices clearly assign connecting elements during the manufacturing process and operation

The coding elements and locking devices are inserted prior to assembly or during the cable assembly phase. The Weidmüller alternative: configure online using the variant configurator to precode prior to delivery.

Incorrect assembly on the circuit board and incorrect plugging of connecting elements is no longer possible. The advantage: no troubleshooting during manufacture and no operational errors by the user.

General ordering data

Type	BV/SV 7.62HP KO	Version	Product data	Packaging
Order No.	1937590000	PCB plug-in connector, Accessories, Coding element, black, Number		Box
GTIN (EAN)	4032248608881	of poles: 1		
Qty.	50 pc(s).			

SV-SMT 7.62HP/04/90G...SC04

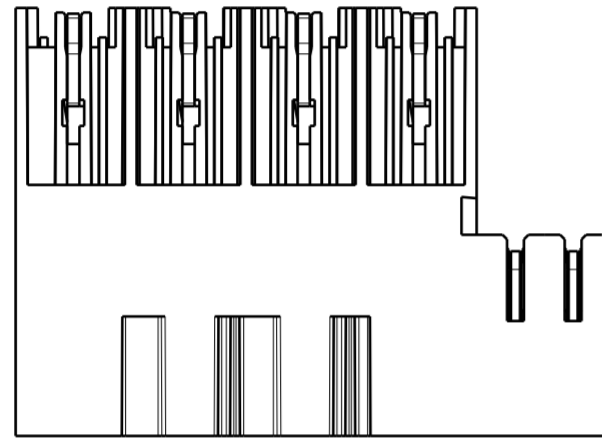
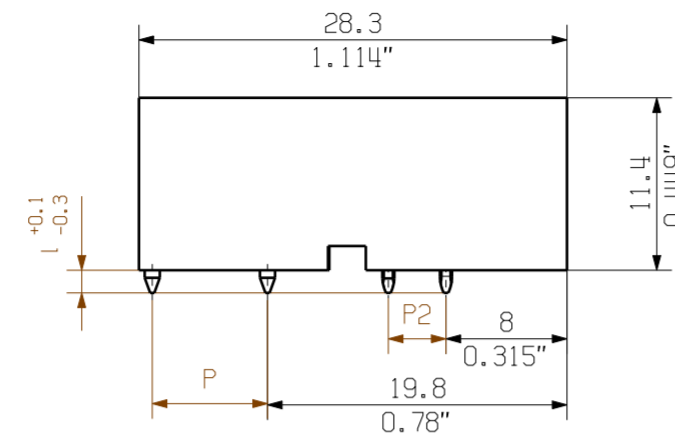
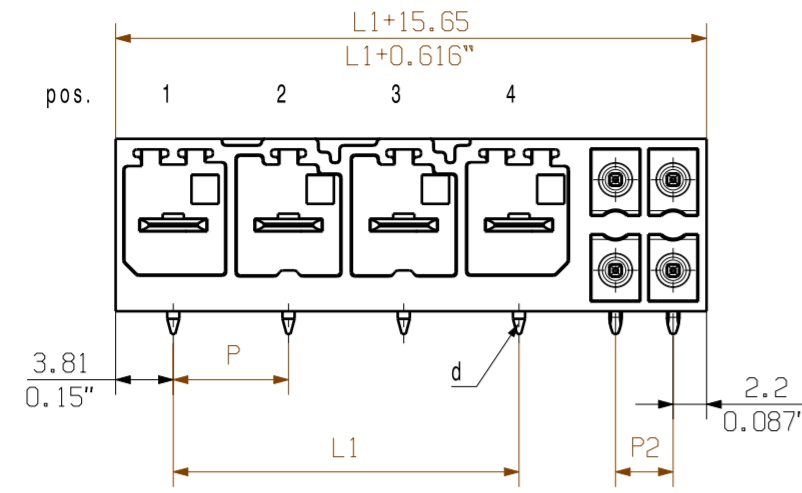

SV-SMT 7.62HP/04/90G SC04

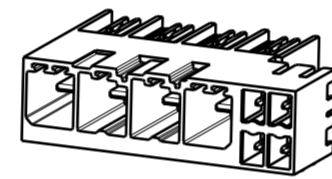

SV-SMT 7.62HP/04/270G...SC04

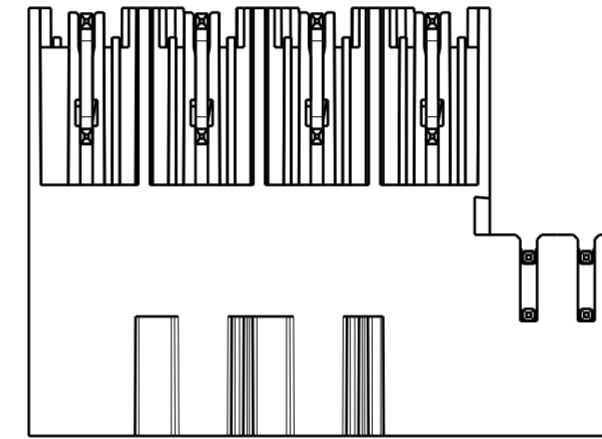
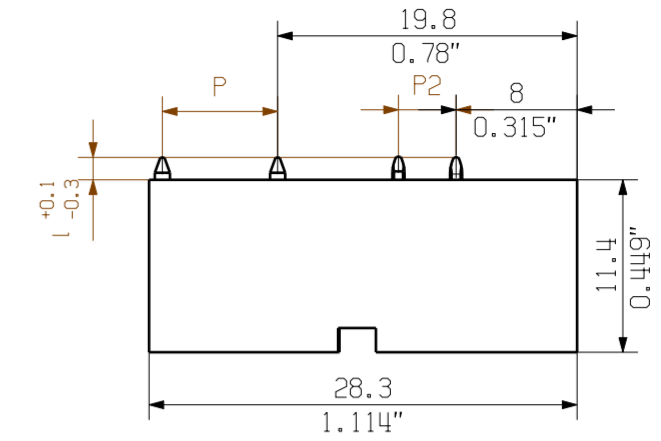
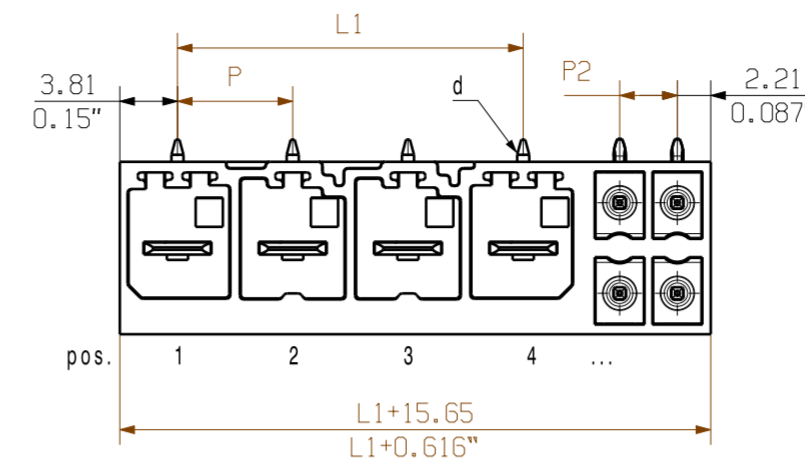

SV-SMT 7.62HP/04/270G SC04

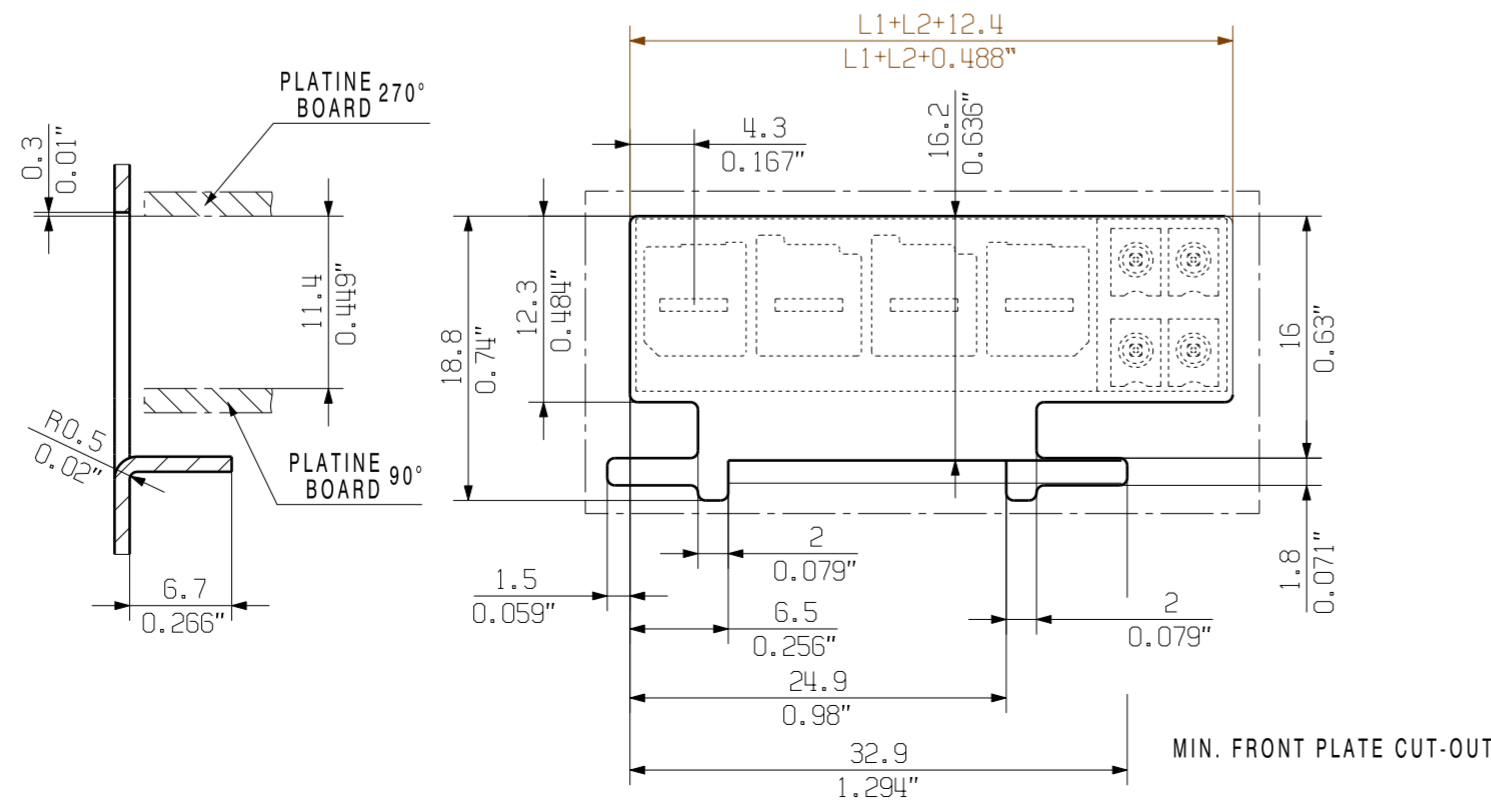
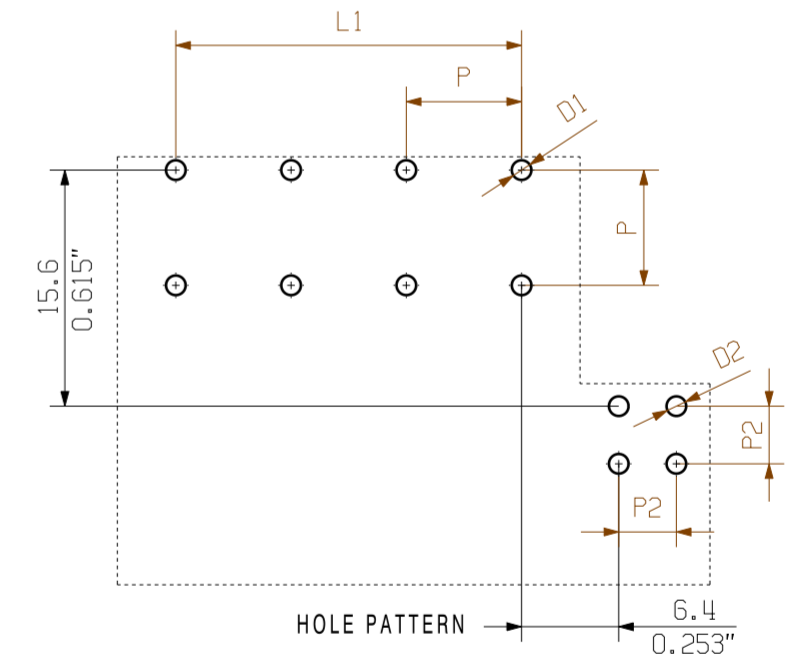
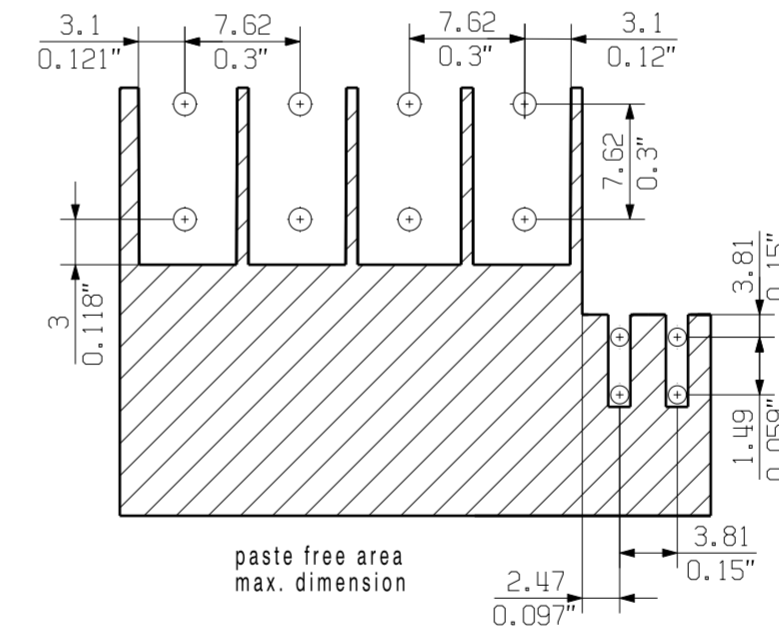
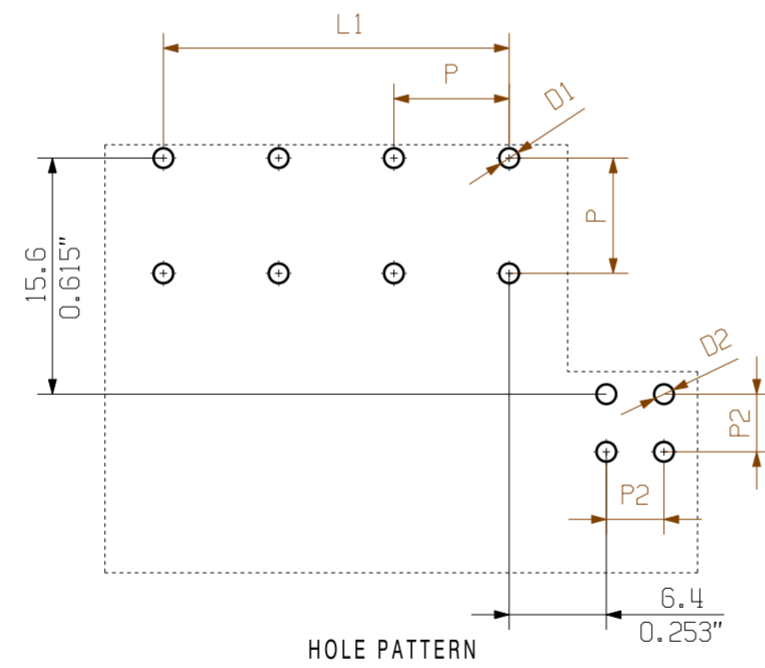
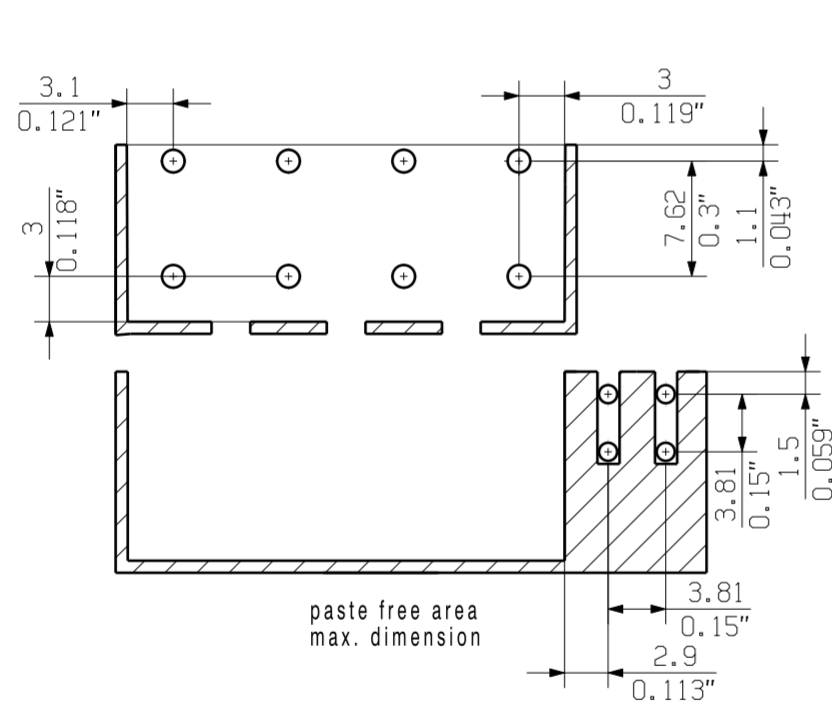
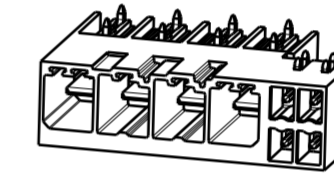

P = Raster / pitch 7.62
 P2 = Raster/pitch 3.81
 D1 = Ø1.4+0.1/-0.05
 D2 = Ø1.2+0.1/-0.05
 d = 0.8x1.0

1.5
2.6
3.5
I
[mm]

05	30.48	1.196	POL	POL	POL	POL	POL
04	22.86	0.897	POL	POL	POL	POL	
03	15.24	0.598	POL	POL	POL		
02	7.62	0.299	POL	POL			
no of poles	L1 [mm]	L1 [inch]	1	2	3	4	5
POSITION							

GENERAL TOLERANCE:
 DIN ISO 2768-m

For the mounting of PCBs, it should be noted that the rated data relates only to the PCB components alone.

The necessary creepage and clearance paths must be observed in connection with the respective applicant in accordance to IEC 664 / VDE 0110. The current-carrying capacity and pitch tolerance is to be determined according to DIN IEC 326 part 3 very fine.

Weidmüller PCB components are tested to the DIN EN 61984 standard, and are valid for its field of application. Provided that the components are used to the intended purpose, all requirements with respect to the occurring of electrical, mechanical, thermic and corrosive stress will be satisfied.

EC00002212	Prim PLM Part No.: 225880	Prim ERP Part No.: 2499550000
RoHS COMPLIANT	Max. nos.	Weidmüller
First Issue Date 14.11.2016	Modification	63450
Drawn 30.08.2019 Helis, Maria	Date 09.10.2019 Lang, Thomas	Issue no. 4
Responsible Döhner, Karl	Approved	Sheet 11 of 17 sheets
Scale: ./.	Size: A2	Product file: 7407 BLF 7.50HP
SV-SMT 7.62HP/IT../90/270... STISTLEISTE MALE HEADER		

Recommended wave soldering profiles

Weidmüller Interface GmbH & Co. KG
 Klängenbergstraße 16
 D-32758 Detmold
 Germany
 Fon: +49 5231 14-0
 Fax: +49 5231 14-292083
 www.weidmueller.com

Single Wave:



Double Wave:

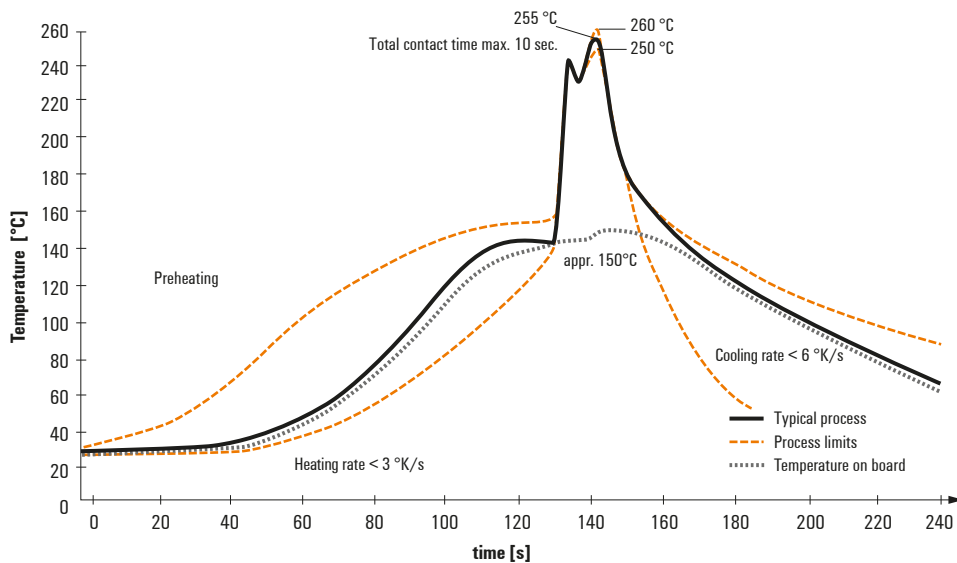

Wave soldering profiles

Wired connection elements should be processed in accordance with the DIN EN 61760-1 standard. We have included two recommendations for practical wave soldering profiles, with which Weidmüller PCB terminals and connectors are qualified.

When choosing a suitable profile for your application, the following factors also need to be considered:

- PCB thickness
- Proportion of Cu in the layers
- Single/double-sided assembly
- Product range
- Heating and cooling rates

The single and double wave profiles each indicate the recommended operating range, including the maximum soldering temperature of 260°C. In practice, the maximum soldering temperature is quite often well below the above maximum profile.

Recommended reflow soldering profile

Weidmüller Interface GmbH & Co. KG
 Klingenbergstraße 16
 D-32758 Detmold
 Germany
 Fon: +49 5231 14-0
 Fax: +49 5231 14-292083
 www.weidmueller.com

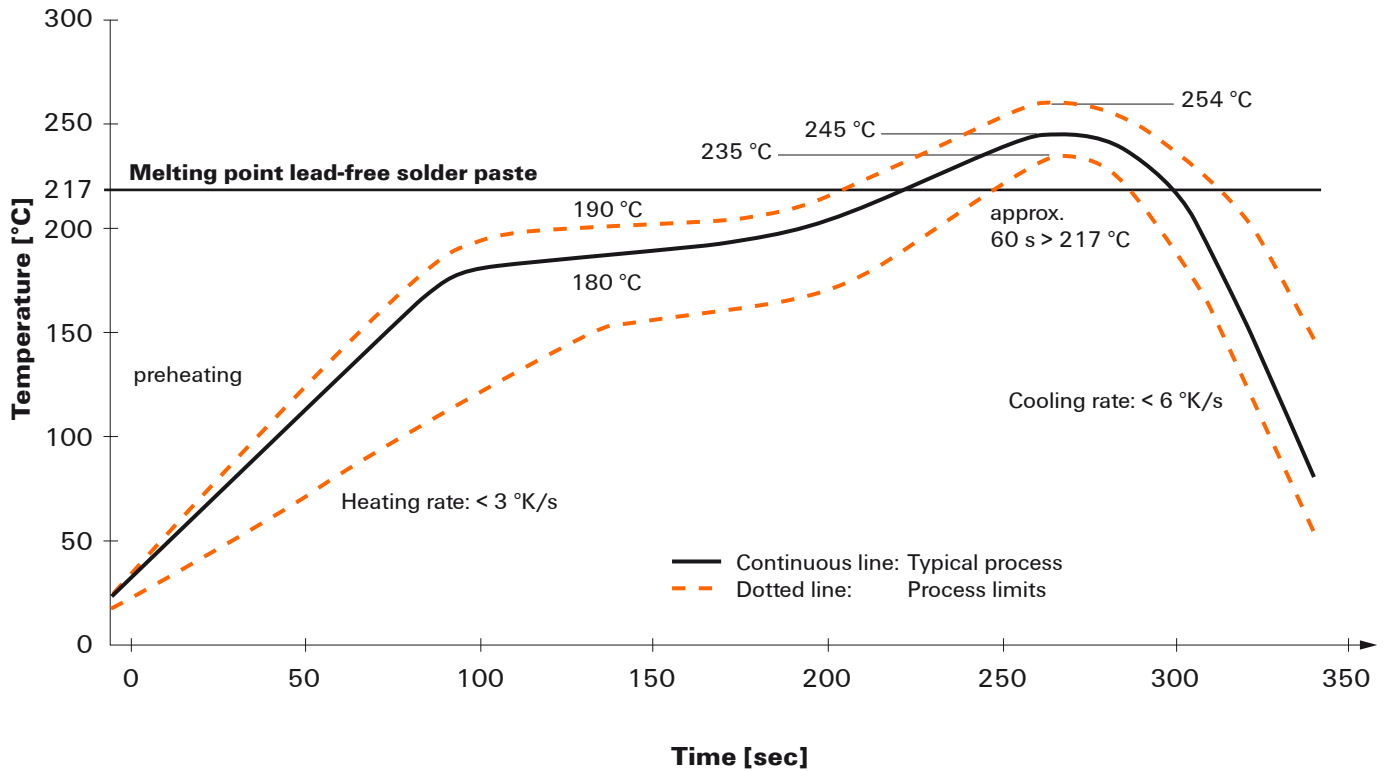

Reflow soldering profile

The perfect soldering profile for SMT Surface Mount Technology is one the most exiting question in SMT production. But there are more than one correct answer: The diagram of temperature-on-time is related to processing features of solder paste and to maximum load of components.

We have to consider the following parameters:

- Time for pre heating
- Maximum temperature
- Time above melting point
- Time for cooling
- Maximum heating rate
- Maximum cooling rate

We recommend a typical solder profile with associated process limits. With preheating components and board are prepared smoothly for the solder phase. Heating rate is typically $\leq +3\text{K/s}$. In parallel the solder paste is ‚activated‘. The time above melting point of 217°C the paste gets liquid and components and boards begin to connect. The maximum temperature of 245°C to 254°C should stay between 10 and 40 seconds. In the cooling phase at $\geq -6\text{K/s}$ solder is cured. Board and components cool down while avoiding cold cracks.