

ACT20X ACT20X-2HDI-2SDO-P

Weidmüller Interface GmbH & Co. KG
 Klingenbergstraße 26
 D-32758 Detmold
 Germany
 Fon: +49 5231 14-0
 Fax: +49 5231 14-292083
 www.weidmueller.com

Product image, Similar to illustration



The ACT20X HDI SDO S / 2HDI-2SDO-S isolating switch amplifiers are specially designed for recording NAMUR sensor signals and digital switching signals which originate from Ex zone 0.

Negative-switching (NPN) transistor outputs are used to transmit the signals to applications in the safe zone.

Integrated alarm contacts issue an alert in the event of a malfunction; this makes troubleshooting easier and increases system availability.

The rail mounted disconnect-switch amplifiers are optionally available in one- or two-channel versions.

With 11 mm width per channel, the devices need little space in the electrical cabinet.

General ordering data

Type	ACT20X-2HDI-2SDO-P
Order No.	2456 100000
Version	EX signal isolating converter, Ex-input: NAMUR sensor/switch, Safe-output: Optocoupler, 2-channel
GTIN (EAN)	4050118471519
Qty.	1 pc(s).

Creation date May 2, 2020 1:58:09 PM CEST

Catalogue status 17.04.2020 / We reserve the right to make technical changes.

ACT20X
ACT20X-2HDI-2SDO-P

Weidmüller Interface GmbH & Co. KG
 Klingenbergstraße 26
 D-32758 Detmold
 Germany
 Fon: +49 5231 14-0
 Fax: +49 5231 14-292083
 www.weidmueller.com

Technical data**Dimensions and weights**

Width	22.5 mm	Width (inches)	0.886 inch
Height	127.3 mm	Height (inches)	5.012 inch
Depth	114.6 mm	Depth (inches)	4.512 inch
Net weight	20 g		

Temperatures

Humidity	0...95 % (no condensation)	Operating temperature, max.	60 °C
Operating temperature, min.	-20 °C	Storage temperature, max.	85 °C
Storage temperature, min.	-20 °C	Operating temperature	-20 °C...60 °C
Storage temperature	-20 °C...85 °C		

Probability of failure

MTBF	215 Years
------	-----------

Environmental Product Compliance

REACH SVHC	Lead 7439-92-1
------------	----------------

Rated data UL

UL certificate	E337701.pdf
----------------	-------------

Input EX

Input frequency	0...5 kHz	Input resistance	1 kΩ
Output signal in case of wire break	< 0.1 mA, > 6.5 mA (in case of wire break)	Pulse duration	> 0.1 ms
Resistance	Parallel resistor 15kΩ, Series resistor 750Ω	Sensor	NAMUR sensor, according to EN60947-5-6, switch with or without RS, RP
Sensor supply	8 V DC / 8 mA	Trigger level high	> 2.1 mA
Trigger level low	< 1.2 mA	Type	intrinsically safe circuit

Alarm output

Alarm function	Line interruption at the input, Short circuit at input, No supply voltage, Device error	Type	Relay, 1 NC (voltage-free)
Nominal switching voltage	≤ 125 V AC / 110 V DC (safe area) ≤ 32 V AC / 32 V DC (zone 2)	Continuous current	≤ 0.5 A AC / 0.3 A DC (safe zone), ≤ 0,5 A AC / 1 A DC (zone 2)
Power rating	≤ 62.5 VA / 32 W (safe area) ≤ 16 VA / 32 W (Zone 2)		

General specifications

Configuration	With FDT/DTM software	Voltage supply	19.2...31.2 V DC
Type of connection	PUSH IN	NAMUR supply	8 V DC / 8 mA
Power consumption	≤ 1.5 W	Protection degree	IP20
Humidity	0...95 % (no condensation)		

Creation date May 2, 2020 1:58:09 PM CEST

Catalogue status 17.04.2020 / We reserve the right to make technical changes.

2

ACT20X
ACT20X-2HDI-2SDO-P

Weidmüller Interface GmbH & Co. KG
 Klingenbergstraße 26
 D-32758 Detmold
 Germany
 Fon: +49 5231 14-0
 Fax: +49 5231 14-292083
 www.weidmueller.com

Technical data
Insulation coordination

EMC standards	DIN EN 61326, NE 21	Insulation voltage	2.6 kV (input / output)
Rated voltage	300 V		

Digital output

Type	NPN-Transistor	Nominal switching voltage	30 V DC
Continuous current	80 mA	Function	Output = input, direct or inverse (configurable)

Data for Ex applications (ATEX)

Voltage U_0	10.6 V DC	Current I_0	12 mA DC
Power P_0	32 mW	Marking	II (1) G [Ex ia Ga] IIC/IIB/ IIA, II (1) D [Ex ia Da] IIIC, I (M1) [Ex ia Ma] I
Installation location	Device installed in safe area, zone 2		

Safety-related basic specifications

Demand mode	High	Demand rate	1,000 s
Description of the "safe state"	High impedance	Device type	B
Diagnostic test interval	10 s	Hardware fault tolerance (HFT)	0
Mean Time To Repair (MTTR)	8 h	Safe Failure Fraction (SFF)	92 %
T_{proof}	5 Years	Total failure rate for dangerous detected failures (λ_{DD})	135 FIT
Total failure rate for dangerous undetected failures (λ_{DU})	36 FIT	Total failure rate for safe detected failures (λ_{SD})	0 FIT
Total failure rate for safe undetected failures (λ_{SU})	275 FIT	Safety category	SIL 2
Probability of outage PFH	$3.62 \times 10^{-8} \text{ h}^{-1}$		

Safety-related specifications Low demand mode

Average Probability of Failure on Demand (PFD_{avg})	1.58×10^{-4} ($T_{proof} = 1$ year), 3.17×10^{-4} ($T_{proof} = 2$ years), 7.92×10^{-4} ($T_{proof} = 5$ years)
--	---

Connection data

Type of connection	PUSH IN	Wire connection cross section AWG, min.	AWG 26
Wire connection cross section AWG, max.	AWG 14	Wire cross-section, solid, min.	0.2 mm ²
Wire cross-section, solid, max.	2.5 mm ²	Wire connection cross-section, finely stranded, min.	0.2 mm ²
Wire connection cross section, finely stranded, max.	2.5 mm ²	Wire connection cross-section, finely stranded with wire-end ferrules DIN 46228/4, min.	0.2 mm ²
Wire connection cross-section, finely stranded with wire-end ferrules DIN 46228/4, max.	2.5 mm ²		

Data sheet

**ACT20X
ACT20X-2HDI-2SDO-P**

Weidmüller Interface GmbH & Co. KG
 Klingenbergstraße 26
 D-32758 Detmold
 Germany
 Fon: +49 5231 14-0
 Fax: +49 5231 14-292083
 www.weidmueller.com

Technical data

Classifications

ETIM 6.0	EC002653	ETIM 7.0	EC002653
eClass 9.0	27-21-01-20	eClass 9.1	27-21-01-20
eClass 10.0	27-21-01-20		

Approvals

Approvals



ROHS	Conform
------	---------

Downloads

Approval/Certificate/Document of Conformity	Certification SIL Certification DNV-GL Certification ATEX Certification IECEX Declaration of Conformity
Engineering Data	STEP
Software	WI-Manager, DTM-Library for online installation V.1.2.0
User Documentation	MAN SAFETY ACT20X-(2)HDI-(2)SDO-S Instruction sheet Handbuch ACT20X- Serie, deutsch Manual ACT20X- series, english

Data sheet

**ACT20X
ACT20X-2HDI-2SDO-P**

Weidmüller Interface GmbH & Co. KG
Klingenbergstraße 26
D-32758 Detmold
Germany
Fon: +49 5231 14-0
Fax: +49 5231 14-292083
www.weidmueller.com

Drawings

Application

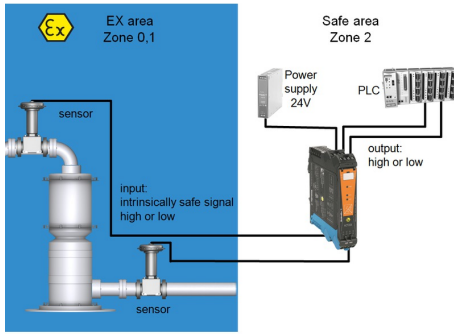

Block diagram

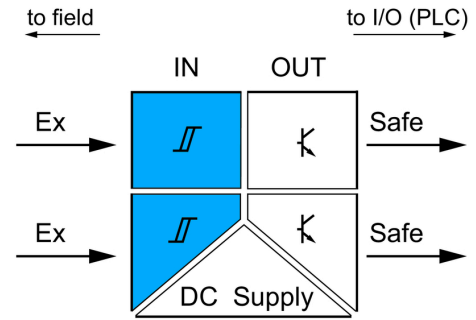

Dimensioned drawing

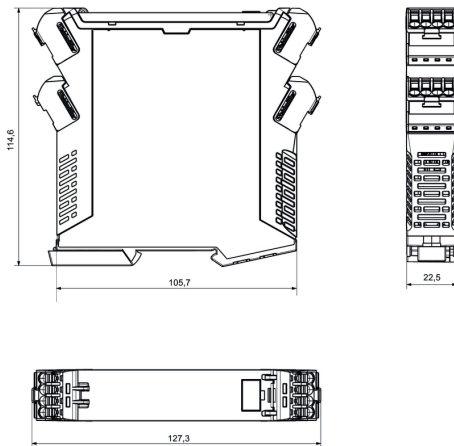

Similar to illustration

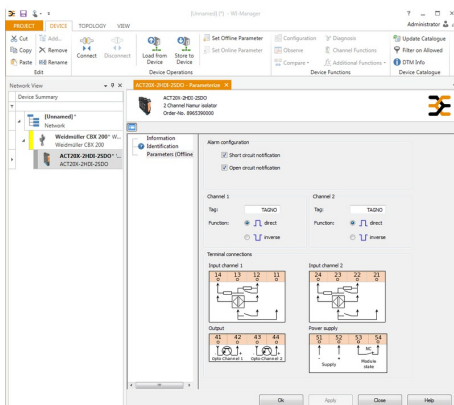

screenshot of configuration with FDT2 / DTM software

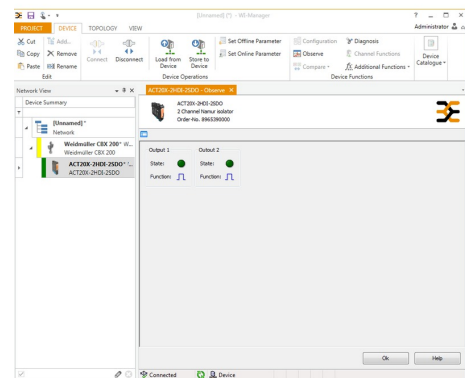

screenshot of "observe" with FDT2 / DTM software

Data sheet

**ACT20X
ACT20X-2HDI-2SDO-P**

Weidmüller Interface GmbH & Co. KG
Klingenbergstraße 26
D-32758 Detmold
Germany
Fon: +49 5231 14-0
Fax: +49 5231 14-292083
www.weidmueller.com

Accessories

Accessories



Accessories for the analogue signal processing products:

- End plates: for components with terminal-block design
- Retaining clips: for mounting IP6X signal isolators and displays
- Calibration devices: for calibrating and setting analogue signal converters
- MICRO interface: for direct transmission to a controller thus minimizing the wiring overhead
- markers
- Programming adapter: for configuring PC-configurable modules
- Cross-connector
- Power supply modules / power supplies
- Optional connection terminals and cold-junction compensation terminals

General ordering data

Type	CBX200 USB
Order No.	8978580000
GTIN (EAN)	4032248813759
Qty.	1 pc(s).

Accessories



Accessories for the analogue signal processing products:

- End plates: for components with terminal-block design
- Retaining clips: for mounting IP6X signal isolators and displays
- Calibration devices: for calibrating and setting analogue signal converters
- MICRO interface: for direct transmission to a controller thus minimizing the wiring overhead
- markers
- Programming adapter: for configuring PC-configurable modules
- Cross-connector
- Power supply modules / power supplies
- Optional connection terminals and cold-junction compensation terminals

General ordering data

Type	ESG 8/13.5/43.3 SAI AU	Version	
Order No.	1912130000	ESG, Device markers x 13.5 mm, PA 66, Colour: Transparent	
GTIN (EAN)	4032248541164		
Qty.	5 pc(s).		

**ACT20X
ACT20X-2HDI-2SDO-P**

Weidmüller Interface GmbH & Co. KG
 Klingenbergstraße 26
 D-32758 Detmold
 Germany
 Fon: +49 5231 14-0
 Fax: +49 5231 14-292083
 www.weidmueller.com

Accessories

Accessories for network-compatible current measuring transducers

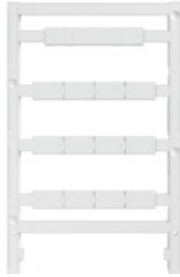

Accessories for the analogue signal processing products:

- End plates: for components with terminal-block design
- Retaining clips: for mounting IP6X signal isolators and displays
- Calibration devices: for calibrating and setting analogue signal converters
- MICRO interface: for direct transmission to a controller thus minimizing the wiring overhead
- markers
- Programming adapter: for configuring PC-configurable modules
- Cross-connector
- Power supply modules / power supplies
- Optional connection terminals and cold-junction compensation terminals

General ordering data

Type	ESG 6.6/20 BHZ 5.00/04	Version
Order No.	1082540000	ESG, Device markers x 20 mm, PA 66, Colour: white
GTIN (EAN)	4032248845439	
Qty.	200 pc(s).	

ACT20X
ACT20X-2HDI-2SDO-P

Weidmüller Interface GmbH & Co. KG
Klingenbergstraße 26
D-32758 Detmold
Germany
Fon: +49 5231 14-0
Fax: +49 5231 14-292083
www.weidmueller.com

Drawings

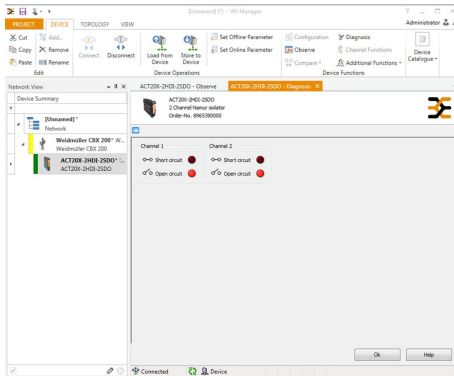

screenshot of "diagnosis" with FDT2 / DTM software

Connection diagram

