

## OMNIMATE Signal - series BC/SC 3.81 BCF 3.81/18/180 SN OR BX

**Weidmüller Interface GmbH & Co. KG**  
Klingenbergstraße 26  
D-32758 Detmold  
Germany  
Fon: +49 5231 14-0  
Fax: +49 5231 14-292083  
www.weidmueller.com

### Product image



Similar to illustration

PUSH IN - Weidmüller's innovative connection system simplifies the wire connection process.

The benefits for users and applications:

- High packaging density due to very low component height. Simply insert the prepared wire - finished
- High component density with the compact SCDN / SCDN-THR two-tier pin header
- Simplified processing due to integrated push buttons for opening the clamping unit
- Intuitive handling – since the wire-entry area and handling area are clearly separated
- tool-free locking and releasing when using Weidmüller's patented release latch (LR)

The Weidmüller plug-in connectors, pitch 3.81 mm (0.15 inch), are compatible with the layout of customary plug-in connectors, can be coded and provide space for printing.

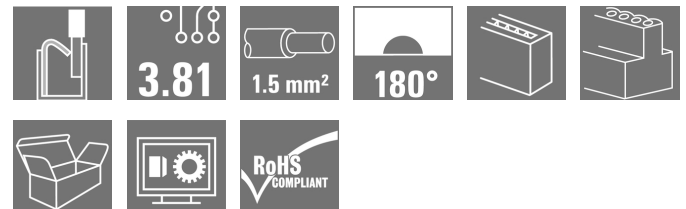

### General ordering data

Type	BCF 3.81/18/180 SN OR BX
Order No.	<a href="#">1969250000</a>
Version	PCB plug-in connector, female plug, 3.81 mm, Number of poles: 18, 180°, PUSH IN, Tension-clamp connection, Clamping range, max. : 1.5 mm², Box
GTIN (EAN)	4032248678037
Qty.	50 pc(s).
Product data	IEC: 320 V / 17.5 A / 0.14 - 1.5 mm² UL: 300 V / 10 A / AWG 26 - AWG 16
Packaging	Box

**OMNIMATE Signal - series BC/SC 3.81  
BCF 3.81/18/180 SN OR BX**

**Weidmüller Interface GmbH & Co. KG**  
Klingenbergstraße 26  
D-32758 Detmold  
Germany  
Fon: +49 5231 14-0  
Fax: +49 5231 14-292083  
www.weidmueller.com

**Technical data****Dimensions and weights**

Width	68.67 mm	Width (inches)	2.704 inch
Height	7.9 mm	Height (inches)	0.311 inch
Depth	22 mm	Depth (inches)	0.866 inch
Net weight	11.6 g		

**System Parameters**

Product family	OMNIMATE Signal - series BC/SC 3.81	Type of connection	Field connection
Wire connection method	PUSH IN, Tension-clamp connection	Pitch in mm (P)	3.81 mm
Pitch in inches (P)	0.15 inch	Conductor outlet direction	180°
Number of poles	18	L1 in mm	64.77 mm
L1 in inches	2.55 inch	Number of rows	1
Pin series quantity	1	Rated cross-section	1 mm <sup>2</sup>
Touch-safe protection acc. to DIN VDE 57 106	Safe from finger touch	Touch-safe protection acc. to DIN VDE 0470	IP 20
Volume resistance	≤ 5mΩ	Can be coded	Yes
Stripping length	9 mm	Actuating force actuating element, max.	40 N
Screwdriver blade	0.4 x 2.5	Screwdriver blade standard	DIN 5264
Plugging cycles	25	Plugging force/pole, max.	8 N
Pulling force/pole, max.	7 N		

**Material data**

Insulating material	PA 66 GF 30	Colour	orange
Colour of operational elements	white	Material of operational elements	PPA GF
Colour chart (similar)	RAL 2000	Insulating material group	II
Comparative Tracking Index (CTI)	≥ 550	Insulation strength	≥ 10 <sup>8</sup> Ω
UL 94 flammability rating	V-0	GWFI	960 °C
Contact material	Copper alloy	Contact surface	tinned
Layer structure of plug contact	4-8 μm Sn matt	Storage temperature, min.	-25 °C
Storage temperature, max.	50 °C	Max. relative humidity during storage	70 %
Operating temperature, min.	-50 °C	Operating temperature, max.	120 °C
Temperature range, installation, min.	-25 °C	Temperature range, installation, max.	120 °C

**Conductors suitable for connection**

Clamping range, min.	0.14 mm <sup>2</sup>
Clamping range, max.	1.5 mm <sup>2</sup>
Wire connection cross section AWG, min.	AWG 26
Wire connection cross section AWG, max.	AWG 16
Solid, min. H05(07) V-U	0.14 mm <sup>2</sup>
Solid, max. H05(07) V-U	1.5 mm <sup>2</sup>
Flexible, min. H05(07) V-K	0.14 mm <sup>2</sup>
Flexible, max. H05(07) V-K	1.5 mm <sup>2</sup>
w. plastic collar ferrule, DIN 46228 pt 4, min.	0.25 mm <sup>2</sup>
w. plastic collar ferrule, DIN 46228 pt 4, max.	1 mm <sup>2</sup>
w. wire end ferrule, DIN 46228 pt 1, min.	0.25 mm <sup>2</sup>
w. wire end ferrule, DIN 46228 pt 1, max.	1.5 mm <sup>2</sup>

Creation date May 3, 2020 5:22:18 AM CEST

## OMNIMATE Signal - series BC/SC 3.81 BCF 3.81/18/180 SN OR BX

**Weidmüller Interface GmbH & Co. KG**  
Klingenbergstraße 26  
D-32758 Detmold  
Germany  
Fon: +49 5231 14-0  
Fax: +49 5231 14-292083  
www.weidmueller.com

### Technical data

Plug gauge in accordance with EN 60999 a x b; ø 2.4 mm x 1.5 mm; 1.9mm

Clampable conductor	Cross-section for conductor connection	Type	fine-wired
		nominal	0.5 mm <sup>2</sup>
wire end ferrule	wire end ferrule	Stripping length	nominal 12 mm
		Recommended wire-end ferrule	<a href="#">H0.5/16 OR</a>
		Stripping length	nominal 10 mm
		Recommended wire-end ferrule	<a href="#">H0.5/10</a>
Cross-section for conductor connection	Type	fine-wired	
	nominal	0.75 mm <sup>2</sup>	
wire end ferrule	wire end ferrule	Stripping length	nominal 12 mm
		Recommended wire-end ferrule	<a href="#">H0.75/16 W</a>
		Stripping length	nominal 10 mm
		Recommended wire-end ferrule	<a href="#">H0.75/10</a>
Cross-section for conductor connection	Type	fine-wired	
	nominal	1 mm <sup>2</sup>	
wire end ferrule	wire end ferrule	Stripping length	nominal 12 mm
		Recommended wire-end ferrule	<a href="#">H1.0/16D R</a>
		Stripping length	nominal 10 mm
		Recommended wire-end ferrule	<a href="#">H1.0/10</a>
Cross-section for conductor connection	Type	fine-wired	
	nominal	0.34 mm <sup>2</sup>	
wire end ferrule	wire end ferrule	Stripping length	nominal 10 mm
		Recommended wire-end ferrule	<a href="#">H0.34/12 TK</a>

Reference text The outside diameter of the plastic collar should not be larger than the pitch (P). Length of ferrules is to be chosen depending on the product and the rated voltage.

Max. clamping range 1.5 mm<sup>2</sup>

### Rated data acc. to IEC

tested acc. to standard	IEC 60664-1, IEC 61984	Rated current, min. number of poles (Tu=20°C)	17.5 A
Rated current, max. number of poles (Tu=20°C)	17.5 A	Rated current, min. number of poles (Tu=40°C)	17.5 A
Rated current, max. number of poles (Tu=40°C)	16.3 A	Rated voltage for surge voltage class / pollution degree II/2	320 V
Rated voltage for surge voltage class / pollution degree III/2	160 V	Rated voltage for surge voltage class / pollution degree III/3	160 V
Rated impulse voltage for surge voltage class/ pollution degree II/2	2.5 kV	Rated impulse voltage for surge voltage class/ pollution degree III/2	2.5 kV
Rated impulse voltage for surge voltage class/ contamination degree III/3	2.5 kV	Short-time withstand current resistance	3 x 1s with 76 A

**OMNIMATE Signal - series BC/SC 3.81  
BCF 3.81/18/180 SN OR BX**

**Weidmüller Interface GmbH & Co. KG**  
 Klingenbergstraße 26  
 D-32758 Detmold  
 Germany  
 Fon: +49 5231 14-0  
 Fax: +49 5231 14-292083  
 www.weidmueller.com

**Technical data****Rated data acc. to CSA**

Institute (CSA)



Certificate No. (CSA)

200039-1121690

Rated voltage (Use group B / CSA)	300 V
Rated voltage (Use group D / CSA)	300 V
Rated current (Use group C / CSA)	11 A
Wire cross-section, AWG, min.	AWG 26
Reference to approval values	Specifications are maximum values, details - see approval certificate.

Rated voltage (Use group C / CSA)	50 V
Rated current (Use group B / CSA)	11 A
Rated current (Use group D / CSA)	11 A
Wire cross-section, AWG, max.	AWG 16

**Rated data acc. to UL 1059**

Institute (cURus)



Certificate No. (cURus)

E60693

Rated voltage (Use group B / UL 1059)	300 V
Rated current (Use group B / UL 1059)	10 A
Wire cross-section, AWG, min.	AWG 26
Reference to approval values	Specifications are maximum values, details - see approval certificate.

Rated voltage (Use group D / UL 1059)	300 V
Rated current (Use group D / UL 1059)	10 A
Wire cross-section, AWG, max.	AWG 16

**Packing**

Packaging	Box	VPE length	25 mm
VPE width	165 mm	VPE height	210 mm

**Classifications**

ETIM 6.0	EC002638	ETIM 7.0	EC002638
eClass 9.0	27-44-03-09	eClass 9.1	27-44-03-09
eClass 10.0	27-44-03-09	UNSPSC	30-21-18-10

## OMNIMATE Signal - series BC/SC 3.81 BCF 3.81/18/180 SN OR BX

**Weidmüller Interface GmbH & Co. KG**  
Klingenbergstraße 26  
D-32758 Detmold  
Germany  
Fon: +49 5231 14-0  
Fax: +49 5231 14-292083  
www.weidmueller.com

## Technical data

### Notes

Notes	<ul style="list-style-type: none"> <li>• Additional colours on request</li> <li>• Rated current related to rated cross-section &amp; min. No. of poles.</li> <li>• P on drawing = pitch</li> <li>• Conductors suitable for connection: 1.5 mm<sup>2</sup> with wire-end ferrule with plastic collar, DIN 46 228/1, with a rated voltage of 125V/2.5 kV with III/3 or 250 V/2.5 kV with II/2</li> <li>• Crimp shape A for wire-end ferrules with crimping tools PZ 1,5 (order no. 9005990000) or PZ 6/5 (order no. 9011460000) for larger wire cross-sections recommended.</li> <li>• Wire end ferrule without plastic collar to DIN 46228/1</li> <li>• Wire end ferrule with plastic collar to DIN 46228/4</li> <li>• Rated data refer only to the component itself. Clearance and creepage distances to other components are to be designed in accordance with the relevant application standards.</li> <li>• The test point can only be used as potential-pickup point.</li> </ul>
IPC conformity	Conformity: The products are developed, manufactured and delivered according international recognized standards and norms and comply with the assured properties in the data sheet resp. fulfill decorative properties in accordance with IPC-A-610 "Class 2". Further claims on the products can be evaluated on request.

### Approvals

Approvals



ROHS Conform

### Downloads

Approval/Certificate/Document of Conformity	<a href="#">CB Certificate</a> <a href="#">CB Testreport</a> <a href="#">Declaration of the Manufacturer</a>
Brochure/Catalogue	<a href="#">FL DRIVES EN</a> <a href="#">MB DEVICE MANUF. EN</a> <a href="#">FL DRIVES DE</a> <a href="#">CAT 2 PORTFOLIOGUIDE EN</a> <a href="#">FL BUILDING SAFETY EN</a> <a href="#">FL APPL LED LIGHTING EN</a> <a href="#">FLIndustr.CONTROLS EN</a> <a href="#">FL MACHINE SAFETY EN</a> <a href="#">FL HEATING ELECTR EN</a> <a href="#">FL APPL INVERTER EN</a> <a href="#">FL_BASE_STATION EN</a> <a href="#">FL ELEVATOR EN</a> <a href="#">FL POWER SUPPLY EN</a> <a href="#">FL 72H SAMPLE SER EN</a> <a href="#">PO OMNIMATE EN</a>
Engineering Data	<a href="#">EPLAN_WSCAD</a>
Engineering Data	<a href="#">STEP</a>
User Documentation	<a href="#">BPZL_PUSH_IN_Connectors_BCF_3_81_EN</a>
White paper PUSH IN wire connection	<a href="#">Download Whitepaper</a>

Creation date May 3, 2020 5:22:18 AM CEST

Catalogue status 17.04.2020 / We reserve the right to make technical changes.

5

**OMNIMATE Signal - series BC/SC 3.81  
BCF 3.81/18/180 SN OR BX**

**Weidmüller Interface GmbH & Co. KG**  
Klingenbergstraße 26  
D-32758 Detmold  
Germany  
Fon: +49 5231 14-0  
Fax: +49 5231 14-292083  
www.weidmueller.com

**Drawings**

**Dimensional drawing**

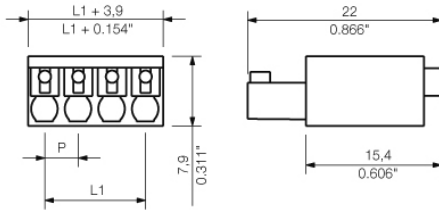

**Graph**

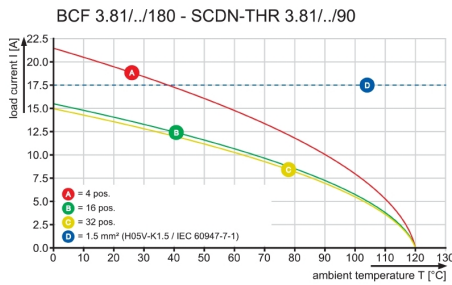

**Graph**

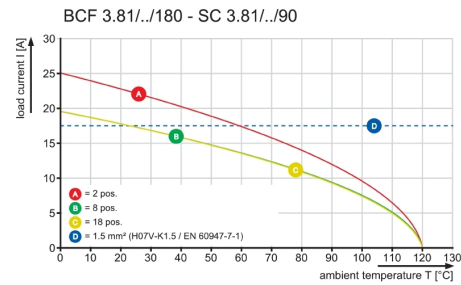

**Graph**

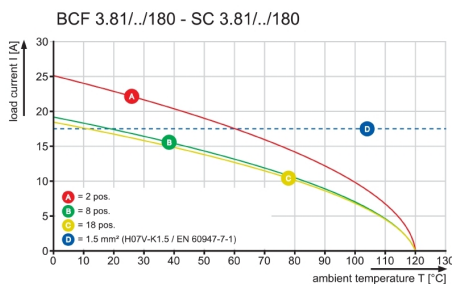

**Product benefits**

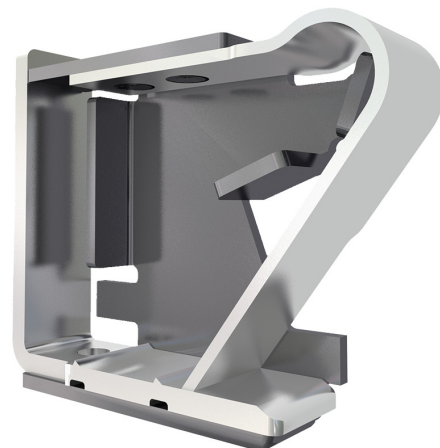

**Solid PUSH IN contact**  
Safe and durable

MASSE OHNE TOLERANZ SIND KEINE PRUEFMASSE  
 DIMS. WITHOUT TOLERANCE ARE NOT CONTROL DIMS.

BCF 3.81/.../180 ... (2,3,4 POLE)



BCF 3.81/.../180LR ...



BCF 3.81/.../180 ... (5- 18 POLE)



BCF 3.81/.../180F ...

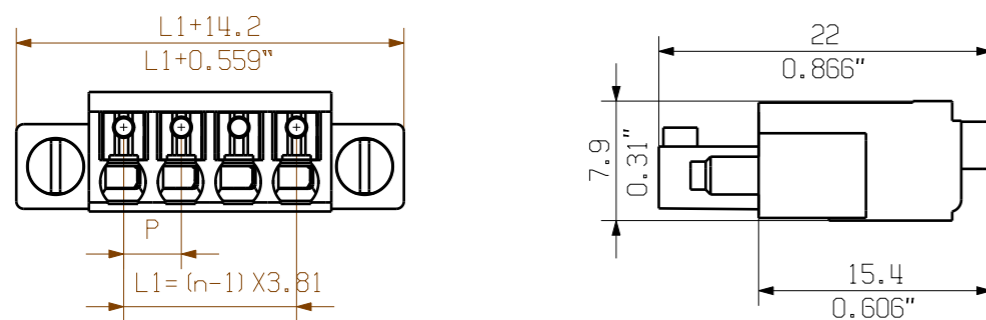

NOTE:

n=NO OF POLES  
 P=PITCH

KUNDENZEICHNUNG  
 CUSTOMER DRAWING

18	64.77	2.550
17	60.96	2.400
16	57.15	2.250
15	53.34	2.100
14	49.53	1.950
13	45.72	1.800
12	41.91	1.650
11	38.10	1.500
10	34.29	1.350
9	30.48	1.200
8	26.67	1.050
7	22.86	0.900
6	19.05	0.750
5	15.24	0.600
4	11.43	0.450
3	7.62	0.300
2	3.81	0.150
n	L1 [mm]	L1 [inch]

For the mounting of PCBs, it should be noted that the rated data given in the catalogue relates only to the connection elements. The necessary creepage and clearance paths must be observed in connection with the respective applicant in accordance to VDE 0110. The current-carrying capacity and pitch tolerance is to be determined according to DIN IEC 326 part 3 very fine.

Weidmüller connectors are tested to the DIN VDE 0627 standard, and are valid for its field of application. Provided that the connectors are used to the intended purpose, all requirements with respect to the occurring of electrical, mechanical, thermic and corrosive stress will be satisfied.

MAX. NRN./NOS. ?		55304/5 18.05.11 GE_G 00		CAT.NO.: .	
MODIFICATION		Weidmüller		C 40414 07	
DRAWN		DATE	NAME	DRAWING NO. SHEET 01 OF 08 SHEETS	
RESPONSIBLE		27.12.2006	XU_S	ISSUE NO.	
CHECKED		03.06.2011	ZHOU_N	BCF 3.81/.../180... SN	
APPROVED			XU_S	BUCHSENLEISTE SOCKET BLOCK	
SCALE: 2/1		PRODUCT FILE: BCF 3.81		7072	
SUPERSEDES: .					

WEITERGABE SOWIE VERVIELFÄLTIGUNG DIESES DOKUMENTS, VERWERTUNG UND MITTEILUNG SEINER INHALTS SIND VERBOTEN, SOWEIT NICHT AUSDRUECKLICH GESTATTET. ZUWIDERHANDLUNGEN VERPFLICHTEN ZU SCHADENERSATZ. ALLE RECHTE FUER DEN FALL DER PATENT-, GEBRAUCHSMUSTER-, ODER GESCHMACKSMUSTEREINTRAGUNG VORBEHALTEN. THE REPRODUCTION, DISTRIBUTION AND UTILIZATION OF THIS DOCUMENT AS WELL AS THE COMMUNICATION OF ITS CONTENTS TO OTHERS WITHOUT EXPLICIT AUTHORIZATION IS PROHIBITED. OFFENDERS WILL BE HELD LIABLE FOR THE PAYMENT OF DAMAGES. WEIDMUELLER EXCLUSIVELY RESERVES THE RIGHT TO FILE FOR PATENTS, UTILITY MODELS OR DESIGNS. WEIDMUELLER INTERFACE GmbH & Co.KG