

## OMNIMATE Signal - series BL/SL 5.08 BLZP 5.08HC/09/90 SN OR BX

**Weidmüller Interface GmbH & Co. KG**  
Klingenbergstraße 26  
D-32758 Detmold  
Germany  
Fon: +49 5231 14-0  
Fax: +49 5231 14-292083  
www.weidmueller.com

### Product image

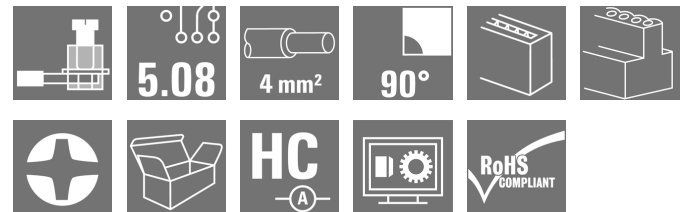

Similar to illustration

Female plugs with clamping-yoke connection for connecting wires with a right-angle (90° or 270°) outlet direction. The female connectors provide space for labelling and can be coded. Fastened by means of a flange or release latch. They also provide an integrated plus/minus screw, protection against faulty insertion of the wire, and they are delivered with open clamping yokes. HC = High Current.

### General ordering data

Type	BLZP 5.08HC/09/90 SN OR BX
Order No.	<a href="#">1948070000</a>
Version	PCB plug-in connector, female plug, 5.08 mm, Number of poles: 9, 90°, Clamping yoke connection, Clamping range, max. : 4 mm², Box
GTIN (EAN)	4032248624294
Qty.	36 pc(s).
Product data	IEC: 400 V / 23 A / 0.2 - 4 mm² UL: 300 V / 20 A / AWG 26 - AWG 12
Packaging	Box

Creation date May 3, 2020 9:21:04 AM CEST

**OMNIMATE Signal - series BL/SL 5.08  
BLZP 5.08HC/09/90 SN OR BX**

**Weidmüller Interface GmbH & Co. KG**  
 Klingenbergstraße 26  
 D-32758 Detmold  
 Germany  
 Fon: +49 5231 14-0  
 Fax: +49 5231 14-292083  
 www.weidmueller.com

**Technical data****Dimensions and weights**

Width	45.72 mm	Width (inches)	1.8 inch
Height	14.1 mm	Height (inches)	0.555 inch
Depth	27.2 mm	Depth (inches)	1.071 inch
Net weight	18.167 g		

**System Parameters**

Product family	OMNIMATE Signal - series BL/SL 5.08	Type of connection	Field connection
Wire connection method	Clamping yoke connection	Pitch in mm (P)	5.08 mm
Pitch in inches (P)	0.2 inch	Conductor outlet direction	90°
Number of poles	9	L1 in mm	40.64 mm
L1 in inches	1.6 inch	Number of rows	1
Pin series quantity	1	Rated cross-section	4 mm <sup>2</sup>
Touch-safe protection acc. to DIN VDE 57 106	Safe from finger touch	Volume resistance	≤ 5mΩ
Can be coded	Yes	Stripping length	7 mm
Tightening torque, min.	0.4 Nm	Tightening torque, max.	0.5 Nm
Clamping screw	M 2.5	Screwdriver blade	0.6 x 3.5, PH 1, PZ 1
Screwdriver blade standard	DIN 5264, ISO 8764/2-PH, ISO 8764/2-PZ	Plugging cycles	25
Plugging force/pole, max.	10 N	Pulling force/pole, max.	9 N

**Material data**

Insulating material	PBT	Colour	orange
Colour chart (similar)	RAL 2000	Insulating material group	IIIa
Comparative Tracking Index (CTI)	≥ 200	Insulation strength	≥ 10 <sup>8</sup> Ω
UL 94 flammability rating	V-0	GWFI	960 °C
Contact material	Copper alloy	Contact surface	tinned
Layer structure of plug contact	4-8 μm Sn hot-dip tinned	Storage temperature, min.	-25 °C
Storage temperature, max.	50 °C	Max. relative humidity during storage	70 %
Operating temperature, min.	-50 °C	Operating temperature, max.	100 °C
Temperature range, installation, min.	-25 °C	Temperature range, installation, max.	100 °C

**Conductors suitable for connection**

Clamping range, min.	0.13 mm <sup>2</sup>	Clamping range, max.	4 mm <sup>2</sup>
Wire connection cross section AWG, min.	AWG 30	Wire connection cross section AWG, max.	AWG 12
Solid, min. H05(07) V-U	0.2 mm <sup>2</sup>	Solid, max. H05(07) V-U	4 mm <sup>2</sup>
Flexible, min. H05(07) V-K	0.2 mm <sup>2</sup>	Flexible, max. H05(07) V-K	4 mm <sup>2</sup>
w. plastic collar ferrule, DIN 46228 pt 4, min.	0.2 mm <sup>2</sup>	w. plastic collar ferrule, DIN 46228 pt 4, max.	2.5 mm <sup>2</sup>
w. wire end ferrule, DIN 46228 pt 1, min.	0.2 mm <sup>2</sup>	w. wire end ferrule, DIN 46228 pt 1, max.	4 mm <sup>2</sup>
Plug gauge in accordance with EN 60999 a x b; ø	2.8 mm x 2.4 mm	Reference text	The outside diameter of the plastic collar should not be larger than the pitch (P). Length of ferrules is to be chosen depending on the product and the rated voltage.
Max. clamping range	4 mm <sup>2</sup>		

**OMNIMATE Signal - series BL/SL 5.08  
BLZP 5.08HC/09/90 SN OR BX**

**Weidmüller Interface GmbH & Co. KG**  
 Klingenbergstraße 26  
 D-32758 Detmold  
 Germany  
 Fon: +49 5231 14-0  
 Fax: +49 5231 14-292083  
 www.weidmueller.com

**Technical data****Rated data acc. to IEC**

tested acc. to standard	IEC 60664-1, IEC 61984	Rated current, min. number of poles (Tu=20°C)	23 A
Rated current, max. number of poles (Tu=20°C)	18 A	Rated current, min. number of poles (Tu=40°C)	21 A
Rated current, max. number of poles (Tu=40°C)	16 A	Rated voltage for surge voltage class / pollution degree II/2	400 V
Rated voltage for surge voltage class / pollution degree III/2	320 V	Rated voltage for surge voltage class / pollution degree III/3	250 V
Rated impulse voltage for surge voltage class/ pollution degree II/2	4 kV	Rated impulse voltage for surge voltage class/ pollution degree III/2	4 kV
Rated impulse voltage for surge voltage class/ contamination degree III/3	4 kV	Short-time withstand current resistance	3 x 1s with 120 A

**Rated data acc. to CSA**

Institute (CSA)		Certificate No. (CSA)	200039-1121690
Rated voltage (Use group B / CSA)	300 V	Rated voltage (Use group C / CSA)	50 V
Rated voltage (Use group D / CSA)	300 V	Rated current (Use group B / CSA)	20 A
Rated current (Use group D / CSA)	20 A	Wire cross-section, AWG, min.	AWG 30
Wire cross-section, AWG, max.	AWG 12	Reference to approval values	Specifications are maximum values, details - see approval certificate.

**Rated data acc. to UL 1059**

Institute (cURus)		Certificate No. (cURus)	E60693
Rated voltage (Use group B / UL 1059)	300 V	Rated voltage (Use group D / UL 1059)	300 V
Rated current (Use group B / UL 1059)	20 A	Rated current (Use group D / UL 1059)	10 A
Wire cross-section, AWG, min.	AWG 26	Wire cross-section, AWG, max.	AWG 12
Reference to approval values	Specifications are maximum values, details - see approval certificate.		

**Packing**

Packaging	Box	VPE length	30 mm
VPE width	135 mm	VPE height	350 mm

**Classifications**

ETIM 6.0	EC002638	ETIM 7.0	EC002638
eClass 9.0	27-44-03-09	eClass 9.1	27-44-03-09
eClass 10.0	27-44-03-09		

**Data sheet**

**OMNIMATE Signal - series BL/SL 5.08  
BLZP 5.08HC/09/90 SN OR BX**

**Weidmüller Interface GmbH & Co. KG**  
Klingenbergstraße 26  
D-32758 Detmold  
Germany  
Fon: +49 5231 14-0  
Fax: +49 5231 14-292083  
www.weidmueller.com

**Technical data**

**Notes**

Notes	<ul style="list-style-type: none"> <li>• Additional colours on request</li> <li>• Gold-plated contact surfaces on request</li> <li>• Rated current related to rated cross-section &amp; min. No. of poles.</li> <li>• Wire end ferrule without plastic collar to DIN 46228/1</li> <li>• Wire end ferrule with plastic collar to DIN 46228/4</li> <li>• P on drawing = pitch</li> <li>• Rated data refer only to the component itself. Clearance and creepage distances to other components are to be designed in accordance with the relevant application standards.</li> </ul>
-------	---

IPC conformity	Conformity: The products are developed, manufactured and delivered according international recognized standards and norms and comply with the assured properties in the data sheet resp. fulfill decorative properties in accordance with IPC-A-610 "Class 2". Further claims on the products can be evaluated on request.
----------------	--

**Approvals**

Approvals



ROHS	Conform
------	---------

**Downloads**

Approval/Certificate/Document of Conformity	<a href="#">Declaration of the Manufacturer</a>
Brochure/Catalogue	<a href="#">FL DRIVES EN</a> <a href="#">MB DEVICE MANUF. EN</a> <a href="#">FL DRIVES DE</a> <a href="#">CAT 2 PORTFOLIOGUIDE EN</a> <a href="#">FL BUILDING SAFETY EN</a> <a href="#">FL APPL LED LIGHTING EN</a> <a href="#">FLIndustr.CONTROLS EN</a> <a href="#">FL MACHINE SAFETY EN</a> <a href="#">FL HEATING ELECTER EN</a> <a href="#">FL APPL INVERTER EN</a> <a href="#">FL_BASE_STATION_EN</a> <a href="#">FL ELEVATOR EN</a> <a href="#">FL POWER SUPPLY EN</a> <a href="#">FL 72H SAMPLE SER EN</a> <a href="#">PO OMNIMATE EN</a>
Engineering Data	<a href="#">EPLAN, WSCAD, Zuken E3.S</a>
Engineering Data	<a href="#">STEP</a>

**OMNIMATE Signal - series BL/SL 5.08  
BLZP 5.08HC/09/90 SN OR BX**

**Weidmüller Interface GmbH & Co. KG**  
Klingenbergstraße 26  
D-32758 Detmold  
Germany  
Fon: +49 5231 14-0  
Fax: +49 5231 14-292083  
[www.weidmueller.com](http://www.weidmueller.com)

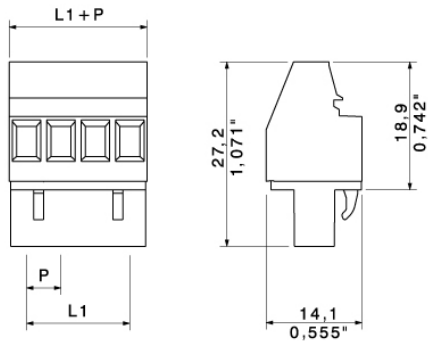
**Drawings****Dimensional drawing**

**OMNIMATE Signal - series BL/SL 5.08  
BLZP 5.08HC/09/90 SN OR BX**

**Weidmüller Interface GmbH & Co. KG**  
Klingenbergstraße 26  
D-32758 Detmold  
Germany  
Fon: +49 5231 14-0  
Fax: +49 5231 14-292083  
www.weidmueller.com

**Mating connector (fully pluggable)**
**SL 5.08HC/90B**

Pin headers made from glass-fibre-reinforced plastic with 90° wire outlet; optimised for wave soldering. The flange variant (F) can be screwed onto the respective counter piece or the circuit board. There is no need for an extra screw to connect the circuit board when the solder flange (LF) version is used. This also protects the solder points from mechanical strain. All pin headers can be manually coded or ordered pre-coded. HC = High Current.

**General ordering data**

Type	SL 5.08HC/09/90B 3.2SN ...	Version	Product data	Packaging
Order No.	<a href="#">1154840000</a>	PCB plug-in connector, male header, Dovetails for fixing blocks, THT	IEC: 400 V / 24 A	Box
GTIN (EAN)	4050118050974	solder connection, 5.08 mm, Number of poles: 9, 90°, Solder pin	UL: 300 V / 18.5 A	
Qty.	50 pc(s).	length (l): 3.2 mm, tinned, orange, Box		
Type	SL 5.08HC/09/90B 3.2SN ...	Version	Product data	Packaging
Order No.	<a href="#">1155650000</a>	PCB plug-in connector, male header, Dovetails for fixing blocks, THT	IEC: 400 V / 24 A	Box
GTIN (EAN)	4050118050288	solder connection, 5.08 mm, Number of poles: 9, 90°, Solder pin	UL: 300 V / 18.5 A	
Qty.	50 pc(s).	length (l): 3.2 mm, tinned, black, Box		

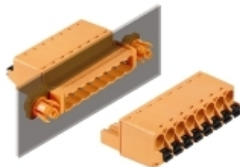
**SLF 5.08/180DF SN**

Male plug with PUSH IN wire connection and straight outlet direction, when used with BLF 5.08HC as wire-to-wire application for panel feed-through The male plugs provide space for labelling and can be coded.

**General ordering data**

Type	SLF 5.08/09/180DF SN OR ...	Version	Product data	Packaging
Order No.	<a href="#">1353670000</a>	PCB plug-in connector, male plug, 5.08 mm, Number of poles: 9,	IEC: 400 V / 25.9 A / 0.2 - 2.5 mm <sup>2</sup>	Box
GTIN (EAN)	4050118156515	180°, PUSH IN, Spring connection, Clamping range, max.: 3.31 mm <sup>2</sup> , UL: 300 V / 14 A / AWG 26 - AWG 12		
Qty.	24 pc(s).	Box		

**OMNIMATE Signal - series BL/SL 5.08  
BLZP 5.08HC/09/90 SN OR BX**

**Weidmüller Interface GmbH & Co. KG**  
Klingenbergstraße 26  
D-32758 Detmold  
Germany  
Fon: +49 5231 14-0  
Fax: +49 5231 14-292083  
www.weidmueller.com

**Mating connector (fully pluggable)**
**SLT 5.08B**

Male plugs with screw TOP wire connection. The male plug provides space for labelling and can be coded.

**General ordering data**

Type	SLT 5.08/09/180B SN OR ...	Version	Product data	Packaging
Order No.	<a href="#">1611780000</a>	PCB plug-in connector, male plug, 5.08 mm, Number of poles: 9,	IEC: 400 V / 16 A / 0.2 - 2.5 mm <sup>2</sup>	Box
GTIN (EAN)	4008190192662	180°, TOP connection, Clamping range, max. : 2.5 mm <sup>2</sup> , Box	UL: 300 V / 15 A / AWG 26 - AWG 14	
Qty.	50 pc(s).			

**SLDV 5.08/90B**

Pin headers with solder pin length optimised for wave flow soldering. The male connectors provide space for labelling and can be coded. HC = High Current.

**General ordering data**

Type	SLD 5.08V/18/90B 3.2 SN ...	Version	Product data	Packaging
Order No.	<a href="#">1726350000</a>	PCB plug-in connector, male header, Dovetails for fixing blocks, THT	IEC: 400 V / 17 A	Box
GTIN (EAN)	4032248061327	solder connection, 5.08 mm, Number of poles: 18, 90°, Solder pin	UL: 300 V / 10 A	
Qty.	20 pc(s).	length (l): 3.2 mm, tinned, orange, Box		

**OMNIMATE Signal - series BL/SL 5.08  
BLZP 5.08HC/09/90 SN OR BX**

**Weidmüller Interface GmbH & Co. KG**  
 Klingenbergstraße 26  
 D-32758 Detmold  
 Germany  
 Fon: +49 5231 14-0  
 Fax: +49 5231 14-292083  
 www.weidmueller.com

**Mating connector (fully pluggable)**
**SL 5.08/90B**

Male connectors with 90° outlet direction. The solder pin length is optimised for wave flow soldering. The pin headers provide space for labelling and can be coded.

**General ordering data**

Type	SL 5.08/09/90B 3.2SN OR ...	Version	Product data	Packaging
Order No.	<a href="#">1511060000</a>	PCB plug-in connector, male header, Dovetails for fixing blocks, THT	IEC: 400 V / 18 A	Box
GTIN (EAN)	4008190135058	solder connection, 5.08 mm, Number of poles: 9, 90°, Solder pin	UL: 300 V / 15 A	
Qty.	50 pc(s).	length (l): 3.2 mm, tinned, orange, Box		

**SL 5.08/135**

Male connectors with 135° outlet direction. The solder pin length is optimised for wave flow soldering. The pin headers provide space for labelling and can be coded.

**General ordering data**

Type	SL 5.08/09/135 3.2SN OR ...	Version	Product data	Packaging
Order No.	<a href="#">1603130000</a>	PCB plug-in connector, male header, open side, THT solder	IEC: 400 V / 17 A	Box
GTIN (EAN)	4008190044299	connection, 5.08 mm, Number of poles: 9, 135°, Solder pin length (l):	UL: 300 V / 15 A	
Qty.	50 pc(s).	3.2 mm, tinned, orange, Box		



**OMNIMATE Signal - series BL/SL 5.08  
BLZP 5.08HC/09/90 SN OR BX**

**Weidmüller Interface GmbH & Co. KG**  
Klingenbergstraße 26  
D-32758 Detmold  
Germany  
Fon: +49 5231 14-0  
Fax: +49 5231 14-292083  
www.weidmueller.com

**Mating connector (fully pluggable)**
**SLDV 5.08/90**

Pin headers with solder pin length optimised for wave flow soldering. The male connectors provide space for labelling and can be coded. HC = High Current.

**General ordering data**

Type	SLD 5.08V/18/90 3.2 SN ...	Version	Product data	Packaging
Order No.	<a href="#">1725240000</a>	PCB plug-in connector, male header, open side, THT solder connection, 5.08 mm, Number of poles: 18, 90°, Solder pin length (l): 3.2 mm, tinned, orange, Box	IEC: 400 V / 17 A UL: 300 V / 10 A	Box
GTIN (EAN)	4032248060641			
Qty.	20 pc(s).			

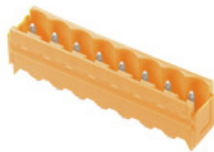
**SL 5.08HC/180B**

Pin headers in glass-fibre-reinforced plastic with straight wire outlet; optimised for wave soldering. The flange variant (F) can be screwed onto the respective counter piece or the circuit board. There is no need for an extra screw to connect the circuit board when the solder flange (LF) version is used. This also protects the solder points from mechanical strain. All pin headers can be manually coded or ordered pre-coded. HC = High Current.

**General ordering data**

Type	SL 5.08HC/09/180B 3.2SN ...	Version	Product data	Packaging
Order No.	<a href="#">1147540000</a>	PCB plug-in connector, male header, Dovetails for fixing blocks, THT solder connection, 5.08 mm, Number of poles: 9, 180°, Solder pin length (l): 3.2 mm, tinned, orange, Box	IEC: 400 V / 24 A UL: 300 V / 18.5 A	Box
GTIN (EAN)	4032248108251			
Qty.	50 pc(s).			
Type	SL 5.08HC/09/180B 3.2SN ...	Version	Product data	Packaging
Order No.	<a href="#">1149630000</a>	PCB plug-in connector, male header, Dovetails for fixing blocks, THT solder connection, 5.08 mm, Number of poles: 9, 180°, Solder pin length (l): 3.2 mm, tinned, black, Box	IEC: 400 V / 24 A UL: 300 V / 18.5 A	Box
GTIN (EAN)	4032248934843			
Qty.	50 pc(s).			

**OMNIMATE Signal - series BL/SL 5.08  
BLZP 5.08HC/09/90 SN OR BX**

**Weidmüller Interface GmbH & Co. KG**  
Klingenbergstraße 26  
D-32758 Detmold  
Germany  
Fon: +49 5231 14-0  
Fax: +49 5231 14-292083  
www.weidmueller.com

**Mating connector (fully pluggable)**
**SL-SMT 5.08/180G Box**

High-temperature-resistant pin header, packed in box or tape. On tape, with 1.5 mm solder pin, optimised for automatic assembly. 3.2 mm solder pin suitable for reflow and wave soldering. The pin headers provide space for labelling and can be coded. HC = High Current.

**General ordering data**

Type	SL-SMT 5.08HC/09/180G 3 ...	Version	Product data	Packaging
Order No.	<a href="#">1838280000</a>	PCB plug-in connector, male header, closed side, THT/THR solder connection, 5.08 mm, Number of poles: 9, 180°, Solder pin length (l): 3.2 mm, tinned, black, Box	IEC: 400 V / 27.5 A UL: 300 V / 18.5 A	Box
GTIN (EAN)	4032248348343			
Qty.	50 pc(s).			
Type	SL-SMT 5.08HC/09/180G 1 ...	Version	Product data	Packaging
Order No.	<a href="#">1775992001</a>	PCB plug-in connector, male header, closed side, THT/THR solder connection, 5.08 mm, Number of poles: 9, 180°, Solder pin length (l): 1.5 mm, tinned, black, Box	IEC: 400 V / 27.5 A UL: 300 V / 18.5 A	Box
GTIN (EAN)	4032248158980			
Qty.	50 pc(s).			

**SL-SMT 5.08/180 Box**

High-temperature-resistant, straight, open pin header. Packed in box or tape. On tape and with 1.5 mm solder pin, optimised for automatic assembly. 3.2 mm solder pin suitable for reflow and wave soldering. The pin headers provide space for labelling and can be coded. HC = High Current.

**General ordering data**

Type	SL-SMT 5.08/09/180 1.5S ...	Version	Product data	Packaging
Order No.	<a href="#">1775672001</a>	PCB plug-in connector, male header, open side, THT/THR solder connection, 5.08 mm, Number of poles: 9, 180°, Solder pin length (l): 1.5 mm, tinned, black, Box	IEC: 400 V / 27.5 A UL: 300 V / 18.5 A	Box
GTIN (EAN)	4032248158317			
Qty.	50 pc(s).			
Type	SL-SMT 5.08HC/09/180 3. ...	Version	Product data	Packaging
Order No.	<a href="#">1838050000</a>	PCB plug-in connector, male header, open side, THT/THR solder connection, 5.08 mm, Number of poles: 9, 180°, Solder pin length (l): 3.2 mm, tinned, black, Box	IEC: 400 V / 27.5 A UL: 300 V / 18.5 A	Box
GTIN (EAN)	4032248348114			
Qty.	50 pc(s).			

**OMNIMATE Signal - series BL/SL 5.08  
BLZP 5.08HC/09/90 SN OR BX**

**Weidmüller Interface GmbH & Co. KG**  
 Klingenbergstraße 26  
 D-32758 Detmold  
 Germany  
 Fon: +49 5231 14-0  
 Fax: +49 5231 14-292083  
 www.weidmueller.com

**Mating connector (fully pluggable)**
**SLDV 5.08/180**

Pin headers with solder pin length optimised for wave flow soldering. The male connectors provide space for labelling and can be coded. HC = High Current.

**General ordering data**

Type	SLD 5.08V/18/180 3.2SN ...	Version	Product data	Packaging
Order No.	<a href="#">1725720000</a>	PCB plug-in connector, male header, open side, THT solder connection, 5.08 mm, Number of poles: 18, 180°, Solder pin length (l): 3.2 mm, tinned, orange, Box	IEC: 400 V / 14 A UL: 300 V / 10 A	Box
GTIN (EAN)	4032248062010			
Qty.	20 pc(s).			

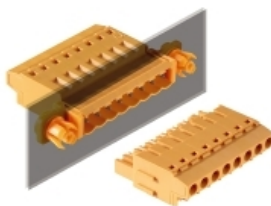
**SLT 5.08/180DF SN**

Male plugs with screw TOP wire connection. The male plug provides space for labelling and can be coded.

**General ordering data**

Type	SLT 5.08/09/180DF SN OR ...	Version	Product data	Packaging
Order No.	<a href="#">1353440000</a>	PCB plug-in connector, male plug, 5.08 mm, Number of poles: 9, 180°, TOP connection, Clamping range, max. : 2.5 mm², Box	IEC: 400 V / 16 A / 0.2 - 2.5 mm² UL: 300 V / 15 A / AWG 26 - AWG 14	Box
GTIN (EAN)	4050118155990			
Qty.	24 pc(s).			

**OMNIMATE Signal - series BL/SL 5.08  
BLZP 5.08HC/09/90 SN OR BX**

**Weidmüller Interface GmbH & Co. KG**  
Klingenbergstraße 26  
D-32758 Detmold  
Germany  
Fon: +49 5231 14-0  
Fax: +49 5231 14-292083  
www.weidmueller.com

**Mating connector (fully pluggable)**
**SL-SMT 5.08HC/90 Box**

High-temperature-resistant, 90° angled, open male header. Packed in box or tape. On tape, with 1.5 mm solder pin, optimised for automatic assembly. 3.2 mm solder pin suitable for reflow and wave soldering. The pin headers provide space for labelling and can be coded. HC = High Current.

**General ordering data**

Type	SL-SMT 5.08HC/09/90 1.5 ...	Version	Product data	Packaging
Order No.	<a href="#">1774832001</a>	PCB plug-in connector, male header, open side, THT/THR solder connection, 5.08 mm, Number of poles: 9, 90°, Solder pin length (l): 1.5 mm, tinned, black, Box	IEC: 400 V / 27.5 A UL: 300 V / 18.5 A	Box
GTIN (EAN)	4032248155873			
Qty.	50 pc(s).			
Type	SL-SMT 5.08HC/09/90 3.2 ...	Version	Product data	Packaging
Order No.	<a href="#">1780020000</a>	PCB plug-in connector, male header, open side, THT/THR solder connection, 5.08 mm, Number of poles: 9, 90°, Solder pin length (l): 3.2 mm, tinned, black, Box	IEC: 400 V / 27.5 A UL: 300 V / 18.5 A	Box
GTIN (EAN)	4032248165346			
Qty.	50 pc(s).			

**SL 5.08/180B**

Male connectors with straight outlet direction. The solder pin length is optimised for wave flow soldering. The pin headers provide space for labelling and can be coded.

**General ordering data**

Type	SL 5.08/09/180B 3.2SN O ...	Version	Product data	Packaging
Order No.	<a href="#">1520260000</a>	PCB plug-in connector, male header, Dovetails for fixing blocks, THT solder connection, 5.08 mm, Number of poles: 9, 180°, Solder pin length (l): 3.2 mm, tinned, orange, Box	IEC: 400 V / 18 A UL: 300 V / 15 A	Box
GTIN (EAN)	4008190120412			
Qty.	50 pc(s).			

**OMNIMATE Signal - series BL/SL 5.08  
BLZP 5.08HC/09/90 SN OR BX**

**Weidmüller Interface GmbH & Co. KG**  
Klingenbergstraße 26  
D-32758 Detmold  
Germany  
Fon: +49 5231 14-0  
Fax: +49 5231 14-292083  
www.weidmueller.com

**Mating connector (fully pluggable)**
**SLF 5.08/180 SN**

Male plug with PUSH IN wire connection and straight outlet direction, when used with BLF 5.08HC as wire-to-wire application for panel feed-through. The male plugs provide space for labelling and can be coded.

**General ordering data**

Type	SLF 5.08/09/180 SN BK BX	Version	Product data	Packaging
Order No.	<a href="#">1335690000</a>	PCB plug-in connector, male plug, 5.08 mm, Number of poles: 9,	IEC: 400 V / 25.9 A / 0.2 - 2.5 mm <sup>2</sup>	Box
GTIN (EAN)	4050118139129	180°, PUSH IN, Spring connection, Clamping range, max.: 3.31 mm <sup>2</sup> , UL: 300 V / 14 A / AWG 26 - AWG 12		
Qty.	36 pc(s).	Box		
Type	SLF 5.08/09/180 SN OR BX	Version	Product data	Packaging
Order No.	<a href="#">1335400000</a>	PCB plug-in connector, male plug, 5.08 mm, Number of poles: 9,	IEC: 400 V / 25.9 A / 0.2 - 2.5 mm <sup>2</sup>	Box
GTIN (EAN)	4050118138641	180°, PUSH IN, Spring connection, Clamping range, max.: 3.31 mm <sup>2</sup> , UL: 300 V / 14 A / AWG 26 - AWG 12		
Qty.	36 pc(s).	Box		

**SL-SMT 5.08HC/90G Box**



High-temperature-resistant pin header, packed in box or tape. On tape, with 1.5 mm solder pin, optimised for automatic assembly. 3.2 mm solder pin suitable for reflow and wave soldering. The pin headers provide space for labelling and can be coded. HC = High Current.

**General ordering data**

Type	SL-SMT 5.08HC/09/90G 3. ...	Version	Product data	Packaging
Order No.	<a href="#">1780250000</a>	PCB plug-in connector, male header, closed side, THT/THR solder connection, 5.08 mm, Number of poles: 9, 90°, Solder pin length (l):	IEC: 400 V / 27.5 A UL: 300 V / 18.5 A	Box
GTIN (EAN)	4032248165575	3.2 mm, tinned, black, Box		
Qty.	50 pc(s).			
Type	SL-SMT 5.08HC/09/90G 1. ...	Version	Product data	Packaging
Order No.	<a href="#">1775072001</a>	PCB plug-in connector, male header, closed side, THT/THR solder connection, 5.08 mm, Number of poles: 9, 90°, Solder pin length (l):	IEC: 400 V / 27.5 A UL: 300 V / 18.5 A	Box
GTIN (EAN)	4032248156542	1.5 mm, tinned, black, Box		
Qty.	50 pc(s).			

**OMNIMATE Signal - series BL/SL 5.08  
BLZP 5.08HC/09/90 SN OR BX**

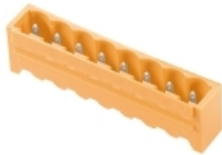
**Weidmüller Interface GmbH & Co. KG**  
Klingenbergstraße 26  
D-32758 Detmold  
Germany  
Fon: +49 5231 14-0  
Fax: +49 5231 14-292083  
www.weidmueller.com

**Mating connector (fully pluggable)**
**SL 5.08HC/180G**

Pin headers in glass-fibre-reinforced plastic with straight wire outlet; optimised for wave soldering. The flange variant (F) can be screwed onto the respective counter piece or the circuit board. There is no need for an extra screw to connect the circuit board when the solder flange (LF) version is used. This also protects the solder points from mechanical strain. All pin headers can be manually coded or ordered pre-coded. HC = High Current.

**General ordering data**

Type	SL 5.08HC/09/180G 3.2SN ...	Version	Product data	Packaging
Order No.	<a href="#">1148870000</a>	PCB plug-in connector, male header, closed side, THT solder connection, 5.08 mm, Number of poles: 9, 180°, Solder pin length (l): 3.2 mm, tinned, black, Box	IEC: 400 V / 24 A UL: 300 V / 18.5 A	Box
GTIN (EAN)	4032248934805			
Qty.	50 pc(s).			
Type	SL 5.08HC/09/180G 3.2SN ...	Version	Product data	Packaging
Order No.	<a href="#">1146890000</a>	PCB plug-in connector, male header, closed side, THT solder connection, 5.08 mm, Number of poles: 9, 180°, Solder pin length (l): 3.2 mm, tinned, orange, Box	IEC: 400 V / 24 A UL: 300 V / 18.5 A	Box
GTIN (EAN)	4032248933884			
Qty.	50 pc(s).			

**SLF 5.08/180B SN**



Male plug with PUSH IN wire connection and straight outlet direction, when used with BLF 5.08HC as wire-to-wire application for panel feed-through The male plugs provide space for labelling and can be coded.

**General ordering data**

Type	SLF 5.08/09/180B SN OR ...	Version	Product data	Packaging
Order No.	<a href="#">1335520000</a>	PCB plug-in connector, male plug, 5.08 mm, Number of poles: 9, 180°, PUSH IN, Spring connection, Clamping range, max.: 3.31 mm², UL: 300 V / 14 A / AWG 26 - AWG 12	IEC: 400 V / 25.9 A / 0.2 - 2.5 mm² UL: 300 V / 14 A / AWG 26 - AWG 12	Box
GTIN (EAN)	4050118138788			
Qty.	36 pc(s).	Box		
Type	SLF 5.08/09/180B SN BK ...	Version	Product data	Packaging
Order No.	<a href="#">1335920000</a>	PCB plug-in connector, male plug, 5.08 mm, Number of poles: 9, 180°, PUSH IN, Spring connection, Clamping range, max.: 3.31 mm², UL: 300 V / 14 A / AWG 26 - AWG 12	IEC: 400 V / 25.9 A / 0.2 - 2.5 mm² UL: 300 V / 14 A / AWG 26 - AWG 12	Box
GTIN (EAN)	4050118140187			
Qty.	36 pc(s).	Box		

**OMNIMATE Signal - series BL/SL 5.08  
BLZP 5.08HC/09/90 SN OR BX**

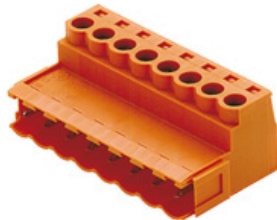
**Weidmüller Interface GmbH & Co. KG**  
Klingenbergstraße 26  
D-32758 Detmold  
Germany  
Fon: +49 5231 14-0  
Fax: +49 5231 14-292083  
www.weidmueller.com

**Mating connector (fully pluggable)**
**SLS 5.08/180B**

Male plugs with clamping-yoke screw wire-connect system. The male plugs provide space for labelling and can be coded.

**General ordering data**

Type	SLS 5.08/09/180B SN OR ...	Version	Product data	Packaging
Order No.	<a href="#">1627310000</a>	PCB plug-in connector, male plug, 5.08 mm, Number of poles: 9,	IEC: 400 V / 21.5 A / 0.2 - 2.5 mm <sup>2</sup>	Box
GTIN (EAN)	4008190199821	180°, Clamping yoke connection, Clamping range, max. : 3.31 mm <sup>2</sup> ,	UL: 300 V / 14 A / AWG 26 - AWG 12	
Qty.	36 pc(s).	Box		

**SL 5.08HC/180**

Pin headers in glass-fibre-reinforced plastic with straight wire outlet; optimised for wave soldering. The flange variant (F) can be screwed onto the respective counter piece or the circuit board. There is no need for an extra screw to connect the circuit board when the solder flange (LF) version is used. This also protects the solder points from mechanical strain. All pin headers can be manually coded or ordered pre-coded. HC = High Current.

**General ordering data**

Type	SL 5.08HC/09/180 3.2SN ...	Version	Product data	Packaging
Order No.	<a href="#">1148270000</a>	PCB plug-in connector, male header, open side, THT solder	IEC: 400 V / 24 A	Box
GTIN (EAN)	4032248934379	connection, 5.08 mm, Number of poles: 9, 180°, Solder pin length (l):	UL: 300 V / 18.5 A	
Qty.	50 pc(s).	3.2 mm, tinned, black, Box		
Type	SL 5.08HC/09/180 3.2SN ...	Version	Product data	Packaging
Order No.	<a href="#">1146510000</a>	PCB plug-in connector, male header, open side, THT solder	IEC: 400 V / 24 A	Box
GTIN (EAN)	4032248933112	connection, 5.08 mm, Number of poles: 9, 180°, Solder pin length (l):	UL: 300 V / 18.5 A	
Qty.	50 pc(s).	3.2 mm, tinned, orange, Box		

**OMNIMATE Signal - series BL/SL 5.08  
BLZP 5.08HC/09/90 SN OR BX**

**Weidmüller Interface GmbH & Co. KG**  
Klingenbergstraße 26  
D-32758 Detmold  
Germany  
Fon: +49 5231 14-0  
Fax: +49 5231 14-292083  
www.weidmueller.com

**Mating connector (fully pluggable)**
**SL 5.08/90**

Male connectors with 90° outlet direction. The solder pin length is optimised for wave flow soldering. The pin headers provide space for labelling and can be coded.

**General ordering data**

Type	SL 5.08/09/90 3.2SN OR ...	Version	Product data	Packaging
Order No.	<a href="#">1508760000</a>	PCB plug-in connector, male header, open side, THT solder	IEC: 400 V / 18 A	Box
GTIN (EAN)	4008190152833	connection, 5.08 mm, Number of poles: 9, 90°, Solder pin length (l):	UL: 300 V / 15 A	
Qty.	50 pc(s).	3.2 mm, tinned, orange, Box		

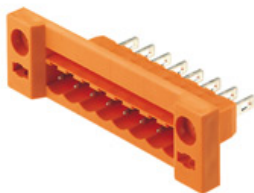
**SLDF 5.08**

Male connector for through-panel mounting with optional locking function. Internal connection as flat-blade or solder connection. These male connectors provide space for labelling and can be coded.

**General ordering data**

Type	SLDF 5.08 L/F 9 SN OR BX	Version	Product data	Packaging
Order No.	<a href="#">1599200000</a>	PCB plug-in connector, male header, 5.08 mm, Number of poles: 9,	IEC: 400 V / 15 A	Box
GTIN (EAN)	4008190084387	180°, Flat-blade connection, Solder connection, Box	UL: 300 V / 10 A	
Qty.	24 pc(s).			



**OMNIMATE Signal - series BL/SL 5.08  
BLZP 5.08HC/09/90 SN OR BX**

**Weidmüller Interface GmbH & Co. KG**  
Klingenbergstraße 26  
D-32758 Detmold  
Germany  
Fon: +49 5231 14-0  
Fax: +49 5231 14-292083  
www.weidmueller.com

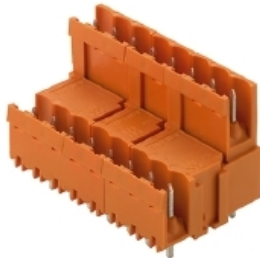
**Mating connector (fully pluggable)**
**SLDV 5.08/180B**

Pin headers with solder pin length optimised for wave flow soldering. The male connectors provide space for labelling and can be coded. HC = High Current.

**General ordering data**

Type	SLD 5.08V/18/180B 3.2SN ...	Version	Product data	Packaging
Order No.	<a href="#">1726810000</a>	PCB plug-in connector, male header, Dovetails for fixing blocks, THT	IEC: 400 V / 14 A	Box
GTIN (EAN)	4032248062690	solder connection, 5.08 mm, Number of poles: 18, 180°, Solder pin	UL: 300 V / 10 A	
Qty.	20 pc(s).	length (l): 3.2 mm, tinned, orange, Box		

**SL 5.08/135B**



Male connectors with 135° outlet direction. The solder pin length is optimised for wave flow soldering. The pin headers provide space for labelling and can be coded.

**General ordering data**

Type	SL 5.08/09/135B 3.2SN O ...	Version	Product data	Packaging
Order No.	<a href="#">1605600000</a>	PCB plug-in connector, male header, Dovetails for fixing blocks, THT	IEC: 400 V / 17 A	Box
GTIN (EAN)	4008190142940	solder connection, 5.08 mm, Number of poles: 9, 135°, Solder pin	UL: 300 V / 15 A	
Qty.	50 pc(s).	length (l): 3.2 mm, tinned, orange, Box		

**OMNIMATE Signal - series BL/SL 5.08  
BLZP 5.08HC/09/90 SN OR BX**

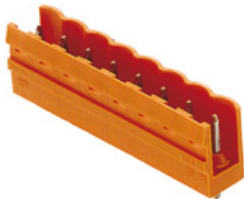
**Weidmüller Interface GmbH & Co. KG**  
 Klingenbergstraße 26  
 D-32758 Detmold  
 Germany  
 Fon: +49 5231 14-0  
 Fax: +49 5231 14-292083  
 www.weidmueller.com

**Mating connector (fully pluggable)**
**SL 5.08/180**

Male connectors with straight outlet direction. The solder pin length is optimised for wave flow soldering. The pin headers provide space for labelling and can be coded.

**General ordering data**

Type	SL 5.08/09/180 3.2SN OR ...	Version	Product data	Packaging
Order No.	<a href="#">1517960000</a>	PCB plug-in connector, male header, open side, THT solder	IEC: 400 V / 18 A	Box
GTIN (EAN)	4008190137090	connection, 5.08 mm, Number of poles: 9, 180°, Solder pin length (l):	UL: 300 V / 15 A	
Qty.	50 pc(s).	3.2 mm, tinned, orange, Box		

**SLS 5.08/180 SN**

Male plugs with clamping-yoke screw wire-connect system. The male plugs provide space for labelling and can be coded.

**General ordering data**

Type	SLS 5.08/09/180 SN OR BX	Version	Product data	Packaging
Order No.	<a href="#">1627160000</a>	PCB plug-in connector, male plug, 5.08 mm, Number of poles: 9,	IEC: 400 V / 21.5 A / 0.2 - 2.5 mm <sup>2</sup>	Box
GTIN (EAN)	4008190199678	180°, Clamping yoke connection, Clamping range, max. : 3.31 mm <sup>2</sup> ,	UL: 300 V / 14 A / AWG 26 - AWG 12	
Qty.	36 pc(s).	Box		

**OMNIMATE Signal - series BL/SL 5.08  
BLZP 5.08HC/09/90 SN OR BX**

**Weidmüller Interface GmbH & Co. KG**  
Klingenbergstraße 26  
D-32758 Detmold  
Germany  
Fon: +49 5231 14-0  
Fax: +49 5231 14-292083  
www.weidmueller.com

**Mating connector (fully pluggable)**
**SL 5.08HC/90**

Pin headers made from glass-fibre-reinforced plastic with 90° wire outlet; optimised for wave soldering. The flange variant (F) can be screwed onto the respective counter piece or the circuit board. There is no need for an extra screw to connect the circuit board when the solder flange (LF) version is used. This also protects the solder points from mechanical strain. All pin headers can be manually coded or ordered pre-coded. HC = High Current.

**General ordering data**

Type	SL 5.08HC/09/90 3.2SN B ...	Version	Product data	Packaging
Order No.	<a href="#">1155100000</a>	PCB plug-in connector, male header, open side, THT solder connection, 5.08 mm, Number of poles: 9, 90°, Solder pin length (l): 3.2 mm, tinned, black, Box	IEC: 400 V / 24 A UL: 300 V / 18.5 A	Box
GTIN (EAN)	4050118050745			
Qty.	50 pc(s).			
Type	SL 5.08HC/09/90 3.2SN O ...	Version	Product data	Packaging
Order No.	<a href="#">1146880000</a>	PCB plug-in connector, male header, open side, THT solder connection, 5.08 mm, Number of poles: 9, 90°, Solder pin length (l): 3.2 mm, tinned, orange, Box	IEC: 400 V / 24 A UL: 300 V / 18.5 A	Box
GTIN (EAN)	4050118051438			
Qty.	50 pc(s).			

## OMNIMATE Signal - series BL/SL 5.08 BLZP 5.08HC/09/90 SN OR BX

**Weidmüller Interface GmbH & Co. KG**  
 Klingenbergstraße 26  
 D-32758 Detmold  
 Germany  
 Fon: +49 5231 14-0  
 Fax: +49 5231 14-292083  
 www.weidmueller.com

# Accessories

### Strain reliefs



#### For frequent load changes: the "trailer coupling" for plug-in connectors.

The strain relief can do more than just relieve the strain on conductors:

Simply clip onto the plug and

- bundle conductors
- guide cables
- use as a connection and disconnection aid

No damage to the connecting points, clear, tidy wiring and easy to handle.

User advantages: permanent heavy-duty connections for harsh industrial environments and convenient operation ensure improved system availability.

### General ordering data

Type	BLZ 5.08 ZE04 BK BX	Version	Product data	Packaging
Order No.	<a href="#">1652130000</a>	PCB plug-in connector, Accessories, Strain relief, black, Number of poles: 4		Box
GTIN (EAN)	4008190401801			
Qty.	50 pc(s).			
Type	BLZ 5.08 ZE04 OR BX	Version	Product data	Packaging
Order No.	<a href="#">1652110000</a>	PCB plug-in connector, Accessories, Strain relief, orange, Number of poles: 4		Box
GTIN (EAN)	4008190401788			
Qty.	50 pc(s).			

### Crosshead screwdriver Phillips

Crosshead screwdriver, Phillips, SDK PH DIN 5262, ISO 8764/2-PH, output to ISO 8764-PH, ChromTop tip, SoftFinish grip



### General ordering data

Type	SDK PH1	Version
Order No.	<a href="#">9008480000</a>	Screwdriver, Blade width (B): 4.5 mm, Blade length: 80 mm
GTIN (EAN)	4032248056477	
Qty.	1 pc(s).	

**OMNIMATE Signal - series BL/SL 5.08  
BLZP 5.08HC/09/90 SN OR BX**

**Weidmüller Interface GmbH & Co. KG**  
Klingenbergstraße 26  
D-32758 Detmold  
Germany  
Fon: +49 5231 14-0  
Fax: +49 5231 14-292083  
www.weidmueller.com

**Accessories**
**Coding elements**

**Only connects what is supposed to be connected:  
the right connection at the right place.**

Coding elements and locking devices clearly assign connecting elements during the manufacturing process and operation

The coding elements and locking devices are inserted prior to assembly or during the cable assembly phase. The Weidmüller alternative: configure online using the variant configurator to precode prior to delivery.

Incorrect assembly on the circuit board and incorrect plugging of connecting elements is no longer possible. The advantage: no troubleshooting during manufacture and no operational errors by the user.

**General ordering data**

Type	BLZ/SL KO BK BX	Version	Product data	Packaging
Order No.	<a href="#">1545710000</a>	PCB plug-in connector, Accessories, Coding element, black, Number		Box
GTIN (EAN)	4008190087142	of poles: 1		
Qty.	50 pc(s).			
Type	BLZ/SL KO OR BX	Version	Product data	Packaging
Order No.	<a href="#">1573010000</a>	PCB plug-in connector, Accessories, Coding element, orange, Number		Box
GTIN (EAN)	4008190048396	of poles: 1		
Qty.	100 pc(s).			

**Crosshead screwdriver Pozidriv**

Crosshead screwdriver, Pozidriv, SDK PZ DIN 5262, ISO 8764/2-PZ, output to ISO 8764/1-PZ, ChromTop tip, SoftFinish grip

**General ordering data**

Type	SDK PZ1	Version
Order No.	<a href="#">9008530000</a>	Screwdriver, Blade width (B): 4.5 mm, Blade length: 80 mm
GTIN (EAN)	4032248056521	
Qty.	1 pc(s).	

**Data sheet**

**OMNIMATE Signal - series BL/SL 5.08  
BLZP 5.08HC/09/90 SN OR BX**

**Weidmüller Interface GmbH & Co. KG**  
Klingenbergstraße 26  
D-32758 Detmold  
Germany  
Fon: +49 5231 14-0  
Fax: +49 5231 14-292083  
www.weidmueller.com

**Accessories**

**Slotted screwdriver**

Slotted screwdriver with rounded blade SD DIN 5265, ISO 2380/2, output to DIN 5264, ISO 2380/1. ChromTop tip, SoftFinish grip



**General ordering data**

Type	SDS 0.6X3.5X100	Version
Order No.	<a href="#">9008330000</a>	Screwdriver, Blade width (B): 3.5 mm, Blade length: 100 mm, Blade thickness (A): 0.6 mm
GTIN (EAN)	4032248056286	
Qty.	1 pc(s).	

**Slotted screwdriver**

VDE insulated slot-head screwdriver, SDI DIN 7437, ISO 2380/2, drive output acc. to DIN 5264, ISO 2380/1. SoftFinish grip



**General ordering data**

Type	SDIS 0.6X3.5X100	Version
Order No.	<a href="#">9008390000</a>	Screwdriver, Blade width (B): 3.5 mm, Blade length: 100 mm, Blade thickness (A): 0.6 mm
GTIN (EAN)	4032248056354	
Qty.	1 pc(s).	

The reproduction, distribution and utilization of this document as well as the communication of its contents to others without explicit authorization is prohibited. Offenders will be held liable for the payment of damages. Weidmüller exclusively reserves the right to file for patents, utility models or designs.

© Weidmüller Interface GmbH & Co. KG

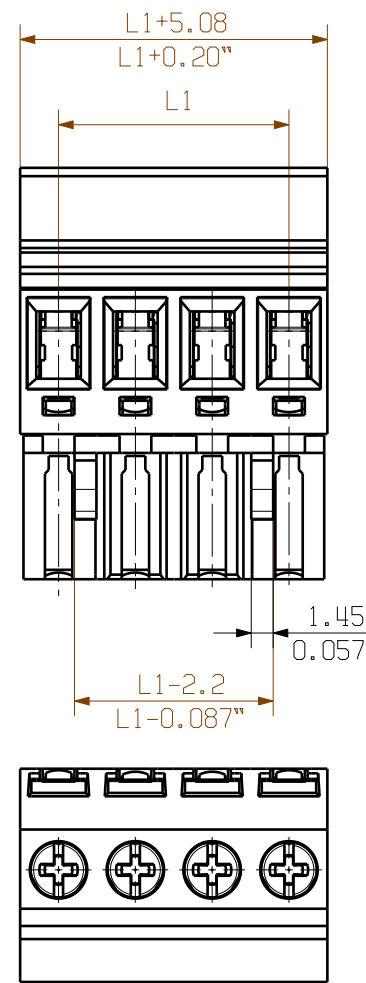

shown:  
BLZP 5.08HC/04/90

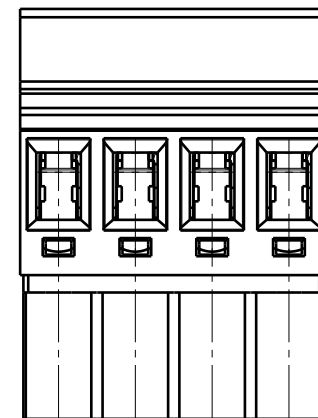
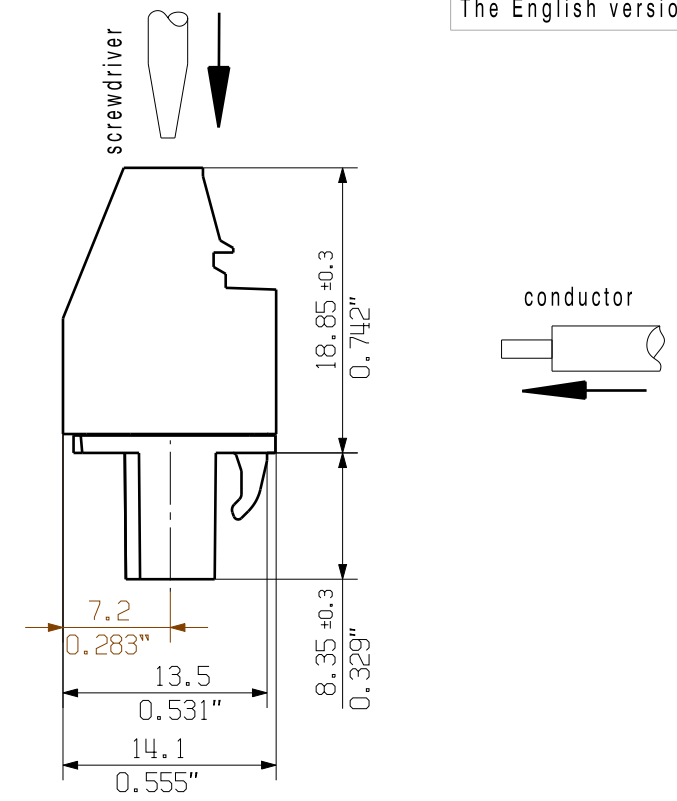

shown:  
BLZP 5.08HC/04/270

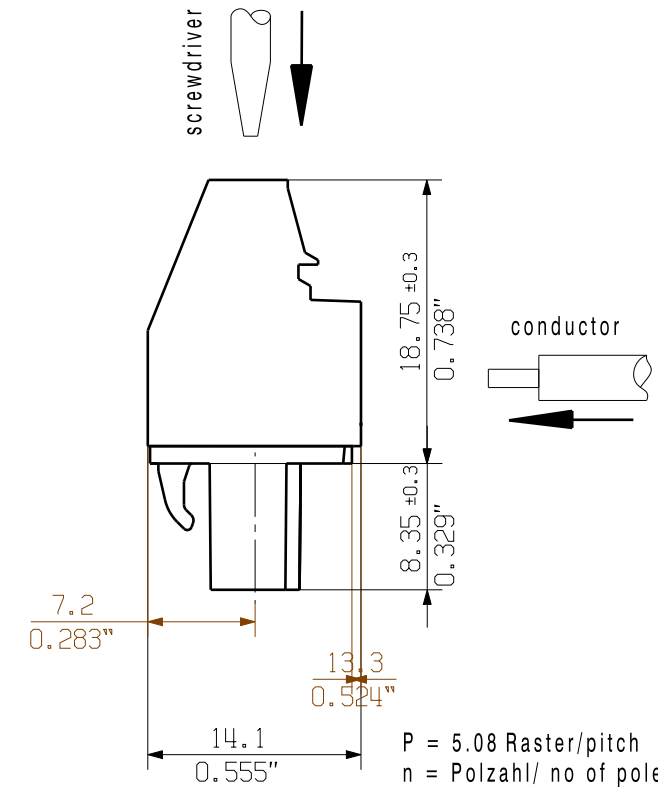

P = 5.08 Raster/pitch  
n = Polzahl/ no of poles

24	116.84	4.60
23	111.76	4.40
22	106.68	4.20
21	101.60	4.00
20	96.52	3.80
19	91.44	3.60
18	86.36	3.40
17	81.28	3.20
16	76.20	3.00
15	71.12	2.80
14	66.04	2.60
13	60.96	2.40
12	55.88	2.20
11	50.80	2.00
10	45.72	1.80
9	40.64	1.60
8	35.56	1.40
7	30.48	1.20
6	25.40	1.00
5	20.32	0.80
4	15.24	0.60
3	10.16	0.40
2	5.08	0.20
n	L1 [mm]	L1 [inch]

For the mounting of PCBs, it should be noted that the rated data given in the catalogue relates only to the connection elements. The necessary creepage and clearance paths must be observed in connection with the respective applicant in accordance to VDE 0110. The current-carrying capacity and pitch tolerance is to be determined according to DIN IEC 326 part 3 very fine.

Weidmüller connectors are tested to the DIN VDE 0627 standard, and are valid for its field of application. Provided that the connectors are used to the intended purpose, all requirements with respect to the occurring of electrical, mechanical, thermal and corrosive stress will be satisfied.

General tolerance: DIN ISO 2768-mK		89239/5 01.08.16 HELIS_MA 02		Cat.no.: .											
		Modification													
		<table border="1"> <tr><td>Drawn</td><td>10.06.2013</td><td>HERTEL_S</td></tr> <tr><td>Responsible</td><td></td><td>HERTEL_S</td></tr> <tr><td>Checked</td><td>08.08.2016</td><td>HELIS_MA</td></tr> <tr><td>Approved</td><td></td><td>LANG_T</td></tr> </table>		Drawn	10.06.2013	HERTEL_S	Responsible		HERTEL_S	Checked	08.08.2016	HELIS_MA	Approved		LANG_T
Drawn	10.06.2013	HERTEL_S													
Responsible		HERTEL_S													
Checked	08.08.2016	HELIS_MA													
Approved		LANG_T													
Scale: 2:1		Supersedes: .		<b>BLZP 5.08HC/.../.../... ..</b> BUCHSENLEISTE SOCKET BLOCK											
						Product file: BLZP 5.08HC <span style="float: right;">7159</span>									