

OMNIMATE Signal - series BL/SL 5.08 BLZP 5.08HC/16/225 SN OR BX

Weidmüller Interface GmbH & Co. KG
Klingenbergstraße 26
D-32758 Detmold
Germany
Fon: +49 5231 14-0
Fax: +49 5231 14-292083
www.weidmueller.com

Product image

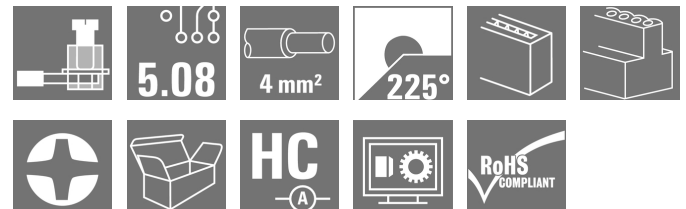

Similar to illustration

Clamping-yoke connection with right-angled (90° or 270°) or angled (225°) outlet direction. The female connectors provide space for labelling and can be coded. Fastened by means of a flange or release latch. They also provide an integrated plus/minus screw, protection against faulty insertion of the wire, and they are delivered with open clamping yokes. HC = High Current.

General ordering data

Type	BLZP 5.08HC/16/225 SN OR BX
Order No.	1946390000
Version	PCB plug-in connector, female plug, 5.08 mm, Number of poles: 16, 225°, Clamping yoke connection, Clamping range, max. : 4 mm², Box
GTIN (EAN)	4032248622160
Qty.	18 pc(s).
Product data	IEC: 400 V / 17.5 A / 0.2 - 4 mm² UL: 300 V / 15 A / AWG 26 - AWG 12
Packaging	Box

Creation date May 3, 2020 9:40:17 AM CEST

**OMNIMATE Signal - series BL/SL 5.08
BLZP 5.08HC/16/225 SN OR BX**

Weidmüller Interface GmbH & Co. KG
Klingenbergstraße 26
D-32758 Detmold
Germany
Fon: +49 5231 14-0
Fax: +49 5231 14-292083
www.weidmueller.com

Technical data**Dimensions and weights**

Width	81.28 mm	Width (inches)	3.2 inch
Height	15.7 mm	Height (inches)	0.618 inch
Depth	23.6 mm	Depth (inches)	0.929 inch
Net weight	31.5 g		

System Parameters

Product family	OMNIMATE Signal - series BL/SL 5.08	Type of connection	Field connection
Wire connection method	Clamping yoke connection	Pitch in mm (P)	5.08 mm
Pitch in inches (P)	0.2 inch	Conductor outlet direction	225°
Number of poles	16	L1 in mm	76.2 mm
L1 in inches	3 inch	Number of rows	1
Pin series quantity	1	Rated cross-section	4 mm ²
Touch-safe protection acc. to DIN VDE 57 106	Safe from finger touch	Touch-safe protection acc. to DIN VDE 0470	IP 20
Volume resistance	≤ 5mΩ	Can be coded	Yes
Stripping length	7 mm	Tightening torque, min.	0.4 Nm
Tightening torque, max.	0.5 Nm	Clamping screw	M 2.5
Screwdriver blade	0.6 x 3.5, PH 1, PZ 1	Screwdriver blade standard	DIN 5264, ISO 8764/2-PH, ISO 8764/2-PZ
Plugging cycles	25	Plugging force/pole, max.	10 N
Pulling force/pole, max.	9 N		

Material data

Insulating material	PBT	Colour	orange
Colour chart (similar)	RAL 2000	Insulating material group	IIIa
Comparative Tracking Index (CTI)	≥ 200	Insulation strength	≥ 10 ⁸ Ω
UL 94 flammability rating	V-0	GWFI	960 °C
Contact material	Copper alloy	Contact surface	tinned
Layer structure of plug contact	4-8 μm Sn hot-dip tinned	Storage temperature, min.	-25 °C
Storage temperature, max.	50 °C	Max. relative humidity during storage	70 %
Operating temperature, min.	-50 °C	Operating temperature, max.	100 °C
Temperature range, installation, min.	-25 °C	Temperature range, installation, max.	100 °C

Conductors suitable for connection

Clamping range, min.	0.13 mm ²	Clamping range, max.	4 mm ²
Wire connection cross section AWG, min.	AWG 30	Wire connection cross section AWG, max.	AWG 12
Solid, min. H05(07) V-U	0.2 mm ²	Solid, max. H05(07) V-U	4 mm ²
Flexible, min. H05(07) V-K	0.2 mm ²	Flexible, max. H05(07) V-K	4 mm ²
w. plastic collar ferrule, DIN 46228 pt 4, min.	0.2 mm ²	w. plastic collar ferrule, DIN 46228 pt 4, max.	2.5 mm ²
w. wire end ferrule, DIN 46228 pt 1, min.	0.2 mm ²	w. wire end ferrule, DIN 46228 pt 1, max.	4 mm ²
Plug gauge in accordance with EN 60999 a x b; ø	2.8 mm x 2.4 mm	Reference text	The outside diameter of the plastic collar should not be larger than the pitch (P). Length of ferrules is to be chosen depending on the product and the rated voltage.
Max. clamping range	4 mm ²		

**OMNIMATE Signal - series BL/SL 5.08
BLZP 5.08HC/16/225 SN OR BX**

Weidmüller Interface GmbH & Co. KG
Klingenbergstraße 26
D-32758 Detmold
Germany
Fon: +49 5231 14-0
Fax: +49 5231 14-292083
www.weidmueller.com



Technical data**Rated data acc. to IEC**

tested acc. to standard	IEC 60664-1, IEC 61984	Rated current, min. number of poles (Tu=20°C)	17.5 A
Rated current, max. number of poles (Tu=20°C)	14 A	Rated current, min. number of poles (Tu=40°C)	14 A
Rated current, max. number of poles (Tu=40°C)	12 A	Rated voltage for surge voltage class / pollution degree II/2	400 V
Rated voltage for surge voltage class / pollution degree III/2	320 V	Rated voltage for surge voltage class / pollution degree III/3	250 V
Rated impulse voltage for surge voltage class/ pollution degree II/2	4 kV	Rated impulse voltage for surge voltage class/ pollution degree III/2	4 kV
Rated impulse voltage for surge voltage class/ contamination degree III/3	4 kV	Short-time withstand current resistance	3 x 1s with 120 A

Rated data acc. to CSA

Institute (CSA)		Certificate No. (CSA)	200039-1121690
Rated voltage (Use group B / CSA)	300 V	Rated voltage (Use group C / CSA)	50 V
Rated voltage (Use group D / CSA)	300 V	Rated current (Use group B / CSA)	15 A
Rated current (Use group D / CSA)	15 A	Wire cross-section, AWG, min.	AWG 30
Wire cross-section, AWG, max.	AWG 12	Reference to approval values	Specifications are maximum values, details - see approval certificate.

Rated data acc. to UL 1059

Institute (UR)		Certificate No. (UR)	E60693
Institute (cURus)		Certificate No. (cURus)	E60693
Rated voltage (Use group B / UL 1059)	300 V	Rated voltage (Use group D / UL 1059)	300 V
Rated current (Use group B / UL 1059)	15 A	Rated current (Use group D / UL 1059)	10 A
Wire cross-section, AWG, min.	AWG 26	Wire cross-section, AWG, max.	AWG 12
Reference to approval values	Specifications are maximum values, details - see approval certificate.		

Packing

Packaging	Box	VPE length	30 mm
VPE width	140 mm	VPE height	350 mm

Classifications

ETIM 6.0	EC002638	ETIM 7.0	EC002638
eClass 9.0	27-44-03-09	eClass 9.1	27-44-03-09
eClass 10.0	27-44-03-09	UNSPSC	30-21-18-01

Data sheet

OMNIMATE Signal - series BL/SL 5.08 BLZP 5.08HC/16/225 SN OR BX

Weidmüller Interface GmbH & Co. KG
Klingenbergstraße 26
D-32758 Detmold
Germany
Fon: +49 5231 14-0
Fax: +49 5231 14-292083
www.weidmueller.com

Technical data

Notes

Notes	<ul style="list-style-type: none"> • Additional colours on request • Gold-plated contact surfaces on request • Rated current related to rated cross-section & min. No. of poles. • Wire end ferrule without plastic collar to DIN 46228/1 • Wire end ferrule with plastic collar to DIN 46228/4 • P on drawing = pitch • Rated data refer only to the component itself. Clearance and creepage distances to other components are to be designed in accordance with the relevant application standards.
-------	---------------------------------------------------------------------------------------------------------------------------------------------------------------------------------------------------------------------------------------------------------------------------------------------------------------------------------------------------------------------------------------------------------------------------------------------------------------------------------------------------------------------------------------------------------------------------------

IPC conformity	Conformity: The products are developed, manufactured and delivered according international recognized standards and norms and comply with the assured properties in the data sheet resp. fulfill decorative properties in accordance with IPC-A-610 "Class 2". Further claims on the products can be evaluated on request.
----------------	----------------------------------------------------------------------------------------------------------------------------------------------------------------------------------------------------------------------------------------------------------------------------------------------------------------------------

Approvals

Approvals



ROHS	Conform
------	---------

Downloads

Approval/Certificate/Document of Conformity	Declaration of the Manufacturer
Brochure/Catalogue	FL DRIVES EN MB DEVICE MANUF. EN FL DRIVES DE CAT 2 PORTFOLIOGUIDE EN FL BUILDING SAFETY EN FL APPL LED LIGHTING EN FLIndustr.CONTROLS EN FL MACHINE SAFETY EN FL HEATING ELECTER EN FL APPL INVERTER EN FL_BASE_STATION_EN FL ELEVATOR EN FL POWER SUPPLY EN PO OMNIMATE EN
Engineering Data	EPLAN_WSCAD
Engineering Data	STEP

Data sheet

**OMNIMATE Signal - series BL/SL 5.08
BLZP 5.08HC/16/225 SN OR BX**

Weidmüller Interface GmbH & Co. KG
Klingenbergstraße 26
D-32758 Detmold
Germany
Fon: +49 5231 14-0
Fax: +49 5231 14-292083
www.weidmueller.com

Drawings

Dimensional drawing

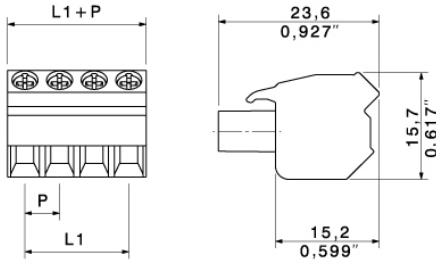

Graph

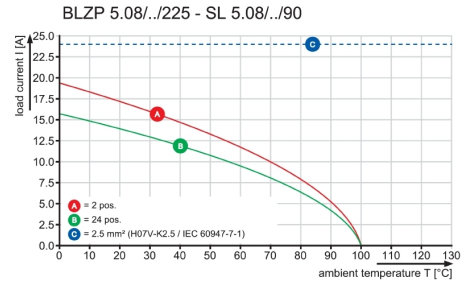

Graph

**OMNIMATE Signal - series BL/SL 5.08
BLZP 5.08HC/16/225 SN OR BX**

Weidmüller Interface GmbH & Co. KG
Klingenbergstraße 26
D-32758 Detmold
Germany
Fon: +49 5231 14-0
Fax: +49 5231 14-292083
www.weidmueller.com

Mating connector (fully pluggable)
SL 5.08HC/90B

Pin headers made from glass-fibre-reinforced plastic with 90° wire outlet; optimised for wave soldering. The flange variant (F) can be screwed onto the respective counter piece or the circuit board. There is no need for an extra screw to connect the circuit board when the solder flange (LF) version is used. This also protects the solder points from mechanical strain. All pin headers can be manually coded or ordered pre-coded. HC = High Current.

General ordering data

Type	SL 5.08HC/16/90B 3.2SN ...	Version	Product data	Packaging
Order No.	1155730000	PCB plug-in connector, male header, Dovetails for fixing blocks, THT	IEC: 400 V / 24 A	Box
GTIN (EAN)	4050118050219	solder connection, 5.08 mm, Number of poles: 16, 90°, Solder pin	UL: 300 V / 18.5 A	
Qty.	50 pc(s).	length (l): 3.2 mm, tinned, black, Box		
Type	SL 5.08HC/16/90B 3.2SN ...	Version	Product data	Packaging
Order No.	1154920000	PCB plug-in connector, male header, Dovetails for fixing blocks, THT	IEC: 400 V / 24 A	Box
GTIN (EAN)	4050118050905	solder connection, 5.08 mm, Number of poles: 16, 90°, Solder pin	UL: 300 V / 18.5 A	
Qty.	50 pc(s).	length (l): 3.2 mm, tinned, orange, Box		

SLT 5.08B

Male plugs with screw TOP wire connection. The male plug provides space for labelling and can be coded.

General ordering data

Type	SLT 5.08/16/180B SN OR ...	Version	Product data	Packaging
Order No.	1611850000	PCB plug-in connector, male plug, 5.08 mm, Number of poles: 16,	IEC: 400 V / 16 A / 0.2 - 2.5 mm ²	Box
GTIN (EAN)	4008190192730	180°, TOP connection, Clamping range, max. : 2.5 mm ² , Box	UL: 300 V / 15 A / AWG 26 - AWG 14	
Qty.	50 pc(s).			

**OMNIMATE Signal - series BL/SL 5.08
BLZP 5.08HC/16/225 SN OR BX**

Weidmüller Interface GmbH & Co. KG
Klingenbergstraße 26
D-32758 Detmold
Germany
Fon: +49 5231 14-0
Fax: +49 5231 14-292083
www.weidmueller.com

Mating connector (fully pluggable)
SLDV 5.08/90B

Pin headers with solder pin length optimised for wave flow soldering. The male connectors provide space for labelling and can be coded. HC = High Current.

General ordering data

Type	SLD 5.08V/32/90B 3.2 SN ...	Version	Product data	Packaging
Order No.	1726420000	PCB plug-in connector, male header, Dovetails for fixing blocks, THT	IEC: 400 V / 17 A	Box
GTIN (EAN)	4032248061396	solder connection, 5.08 mm, Number of poles: 32, 90°, Solder pin	UL: 300 V / 10 A	
Qty.	10 pc(s).	length (l): 3.2 mm, tinned, orange, Box		

SL 5.08/90B

Male connectors with 90° outlet direction. The solder pin length is optimised for wave flow soldering. The pin headers provide space for labelling and can be coded.

General ordering data

Type	SL 5.08/16/90B 3.2SN OR ...	Version	Product data	Packaging
Order No.	1511760000	PCB plug-in connector, male header, Dovetails for fixing blocks, THT	IEC: 400 V / 18 A	Box
GTIN (EAN)	4008190020552	solder connection, 5.08 mm, Number of poles: 16, 90°, Solder pin	UL: 300 V / 15 A	
Qty.	50 pc(s).	length (l): 3.2 mm, tinned, orange, Box		

**OMNIMATE Signal - series BL/SL 5.08
BLZP 5.08HC/16/225 SN OR BX**

Weidmüller Interface GmbH & Co. KG
Klingenbergstraße 26
D-32758 Detmold
Germany
Fon: +49 5231 14-0
Fax: +49 5231 14-292083
www.weidmueller.com

Mating connector (fully pluggable)
SL 5.08/135

Male connectors with 135° outlet direction. The solder pin length is optimised for wave flow soldering. The pin headers provide space for labelling and can be coded.

General ordering data

Type	SL 5.08/16/135 3.2SN OR ...	Version	Product data	Packaging
Order No.	1603200000	PCB plug-in connector, male header, open side, THT solder	IEC: 400 V / 17 A	Box
GTIN (EAN)	4008190123635	connection, 5.08 mm, Number of poles: 16, 135°, Solder pin length	UL: 300 V / 15 A	
Qty.	50 pc(s).	(I): 3.2 mm, tinned, orange, Box		

SLDV 5.08/90

Pin headers with solder pin length optimised for wave flow soldering. The male connectors provide space for labelling and can be coded. HC = High Current.

General ordering data

Type	SLD 5.08V/32/90 3.2 SN ...	Version	Product data	Packaging
Order No.	1725310000	PCB plug-in connector, male header, open side, THT solder	IEC: 400 V / 17 A	Box
GTIN (EAN)	4032248060719	connection, 5.08 mm, Number of poles: 32, 90°, Solder pin length (I):	UL: 300 V / 10 A	
Qty.	10 pc(s).	3.2 mm, tinned, orange, Box		

**OMNIMATE Signal - series BL/SL 5.08
BLZP 5.08HC/16/225 SN OR BX**

Weidmüller Interface GmbH & Co. KG
Klingenbergstraße 26
D-32758 Detmold
Germany
Fon: +49 5231 14-0
Fax: +49 5231 14-292083
www.weidmueller.com

Mating connector (fully pluggable)
SL 5.08HC/180B

Pin headers in glass-fibre-reinforced plastic with straight wire outlet; optimised for wave soldering. The flange variant (F) can be screwed onto the respective counter piece or the circuit board. There is no need for an extra screw to connect the circuit board when the solder flange (LF) version is used. This also protects the solder points from mechanical strain. All pin headers can be manually coded or ordered pre-coded. HC = High Current.

General ordering data

Type	SL 5.08HC/16/180B 3.2SN ...	Version	Product data	Packaging
Order No.	1149870000	PCB plug-in connector, male header, Dovetails for fixing blocks, THT	IEC: 400 V / 24 A	Box
GTIN (EAN)	4032248934263	solder connection, 5.08 mm, Number of poles: 16, 180°, Solder pin	UL: 300 V / 18.5 A	
Qty.	50 pc(s).	length (l): 3.2 mm, tinned, black, Box		
Type	SL 5.08HC/16/180B 3.2SN ...	Version	Product data	Packaging
Order No.	1147770000	PCB plug-in connector, male header, Dovetails for fixing blocks, THT	IEC: 400 V / 24 A	Box
GTIN (EAN)	4032248933747	solder connection, 5.08 mm, Number of poles: 16, 180°, Solder pin	UL: 300 V / 18.5 A	
Qty.	50 pc(s).	length (l): 3.2 mm, tinned, orange, Box		

SL-SMT 5.08/180G Box

High-temperature-resistant pin header, packed in box or tape. On tape, with 1.5 mm solder pin, optimised for automatic assembly. 3.2 mm solder pin suitable for reflow and wave soldering. The pin headers provide space for labelling and can be coded. HC = High Current.

General ordering data

Type	SL-SMT 5.08HC/16/180G 3 ...	Version	Product data	Packaging
Order No.	1838350000	PCB plug-in connector, male header, closed side, THT/THR solder	IEC: 400 V / 27.5 A	Box
GTIN (EAN)	4032248348411	connection, 5.08 mm, Number of poles: 16, 180°, Solder pin length	UL: 300 V / 18.5 A	
Qty.	50 pc(s).	(l): 3.2 mm, tinned, black, Box		
Type	SL-SMT 5.08HC/16/180G 1 ...	Version	Product data	Packaging
Order No.	1776272001	PCB plug-in connector, male header, closed side, THT/THR solder	IEC: 400 V / 27.5 A	Box
GTIN (EAN)	4032248159055	connection, 5.08 mm, Number of poles: 16, 180°, Solder pin length	UL: 300 V / 18.5 A	
Qty.	50 pc(s).	(l): 1.5 mm, tinned, black, Box		

**OMNIMATE Signal - series BL/SL 5.08
BLZP 5.08HC/16/225 SN OR BX**

Weidmüller Interface GmbH & Co. KG
Klingenbergstraße 26
D-32758 Detmold
Germany
Fon: +49 5231 14-0
Fax: +49 5231 14-292083
www.weidmueller.com

Mating connector (fully pluggable)
SL-SMT 5.08/180 Box

High-temperature-resistant, straight, open pin header. Packed in box or tape. On tape and with 1.5 mm solder pin, optimised for automatic assembly. 3.2 mm solder pin suitable for reflow and wave soldering. The pin headers provide space for labelling and can be coded. HC = High Current.

General ordering data

Type	SL-SMT 5.08/16/180 1.5S ...	Version	Product data	Packaging
Order No.	1775742001	PCB plug-in connector, male header, open side, THT/THR solder connection, 5.08 mm, Number of poles: 16, 180°, Solder pin length (l): 1.5 mm, tinned, black, Box	IEC: 400 V / 27.5 A UL: 300 V / 18.5 A	Box
GTIN (EAN)	4032248158393			
Qty.	50 pc(s).			
Type	SL-SMT 5.08HC/16/180 3. ...	Version	Product data	Packaging
Order No.	1838120000	PCB plug-in connector, male header, open side, THT/THR solder connection, 5.08 mm, Number of poles: 16, 180°, Solder pin length (l): 3.2 mm, tinned, black, Box	IEC: 400 V / 27.5 A UL: 300 V / 18.5 A	Box
GTIN (EAN)	4032248348183			
Qty.	50 pc(s).			

SLDV 5.08/180

Pin headers with solder pin length optimised for wave flow soldering. The male connectors provide space for labelling and can be coded. HC = High Current.

General ordering data

Type	SLD 5.08V/32/180 3.2SN ...	Version	Product data	Packaging
Order No.	1725790000	PCB plug-in connector, male header, open side, THT solder connection, 5.08 mm, Number of poles: 32, 180°, Solder pin length (l): 3.2 mm, tinned, orange, Box	IEC: 400 V / 14 A UL: 300 V / 10 A	Box
GTIN (EAN)	4032248062089			
Qty.	10 pc(s).			

**OMNIMATE Signal - series BL/SL 5.08
BLZP 5.08HC/16/225 SN OR BX**

Weidmüller Interface GmbH & Co. KG
Klingenbergstraße 26
D-32758 Detmold
Germany
Fon: +49 5231 14-0
Fax: +49 5231 14-292083
www.weidmueller.com

Mating connector (fully pluggable)
SL-SMT 5.08HC/90 Box

High-temperature-resistant, 90° angled, open male header. Packed in box or tape. On tape, with 1.5 mm solder pin, optimised for automatic assembly. 3.2 mm solder pin suitable for reflow and wave soldering. The pin headers provide space for labelling and can be coded. HC = High Current.

General ordering data

Type	SL-SMT 5.08HC/16/90 1.5 ...	Version	Product data	Packaging
Order No.	1774902001	PCB plug-in connector, male header, open side, THT/THR solder connection, 5.08 mm, Number of poles: 16, 90°, Solder pin length (l): 1.5 mm, tinned, black, Box	IEC: 400 V / 27.5 A UL: 300 V / 18.5 A	Box
GTIN (EAN)	4032248155842			
Qty.	50 pc(s).			
Type	SL-SMT 5.08HC/16/90 3.2 ...	Version	Product data	Packaging
Order No.	1780090000	PCB plug-in connector, male header, open side, THT/THR solder connection, 5.08 mm, Number of poles: 16, 90°, Solder pin length (l): 3.2 mm, tinned, black, Box	IEC: 400 V / 27.5 A UL: 300 V / 18.5 A	Box
GTIN (EAN)	4032248165414			
Qty.	50 pc(s).			

SL 5.08/180B



Male connectors with straight outlet direction. The solder pin length is optimised for wave flow soldering. The pin headers provide space for labelling and can be coded.

General ordering data

Type	SL 5.08/16/180B 3.2SN O ...	Version	Product data	Packaging
Order No.	1520960000	PCB plug-in connector, male header, Dovetails for fixing blocks, THT solder connection, 5.08 mm, Number of poles: 16, 180°, Solder pin length (l): 3.2 mm, tinned, orange, Box	IEC: 400 V / 18 A UL: 300 V / 15 A	Box
GTIN (EAN)	4008190145149			
Qty.	50 pc(s).			

**OMNIMATE Signal - series BL/SL 5.08
BLZP 5.08HC/16/225 SN OR BX**

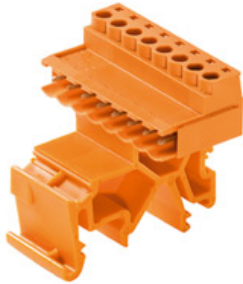
Weidmüller Interface GmbH & Co. KG
Klingenbergstraße 26
D-32758 Detmold
Germany
Fon: +49 5231 14-0
Fax: +49 5231 14-292083
www.weidmueller.com

Mating connector (fully pluggable)
SLS 5.08TB KF35

Male plugs with clamping-yoke screw wire-connect system. With clip-on feet for attaching the male plugs on rail. The male plugs provide space for labelling and can be coded.

General ordering data

Type	SLS 5.08/16/180TB KF SN ...	Version	Product data	Packaging
Order No.	1846180000	PCB plug-in connector, male plug, 5.08 mm, Number of poles: 16,	IEC: 400 V / 21.5 A / 0.2 - 2.5 mm ²	Box
GTIN (EAN)	4032248362462	180°, Clamping yoke connection, Clamping range, max. : 3.31 mm ² ,	UL: 300 V / 14 A / AWG 26 - AWG 12	
Qty.	5 pc(s).	Box		

SL-SMT 5.08HC/90G Box

High-temperature-resistant pin header, packed in box or tape. On tape, with 1.5 mm solder pin, optimised for automatic assembly. 3.2 mm solder pin suitable for reflow and wave soldering. The pin headers provide space for labelling and can be coded. HC = High Current.

General ordering data

Type	SL-SMT 5.08HC/16/90G 3. ...	Version	Product data	Packaging
Order No.	1780320000	PCB plug-in connector, male header, closed side, THT/THR solder	IEC: 400 V / 27.5 A	Box
GTIN (EAN)	4032248165643	connection, 5.08 mm, Number of poles: 16, 90°, Solder pin length (l):	UL: 300 V / 18.5 A	
Qty.	50 pc(s).	3.2 mm, tinned, black, Box		
Type	SL-SMT 5.08HC/16/90G 1. ...	Version	Product data	Packaging
Order No.	1775142001	PCB plug-in connector, male header, closed side, THT/THR solder	IEC: 400 V / 27.5 A	Box
GTIN (EAN)	4032248156719	connection, 5.08 mm, Number of poles: 16, 90°, Solder pin length (l):	UL: 300 V / 18.5 A	
Qty.	50 pc(s).	1.5 mm, tinned, black, Box		

**OMNIMATE Signal - series BL/SL 5.08
BLZP 5.08HC/16/225 SN OR BX**

Weidmüller Interface GmbH & Co. KG
Klingenbergstraße 26
D-32758 Detmold
Germany
Fon: +49 5231 14-0
Fax: +49 5231 14-292083
www.weidmueller.com

Mating connector (fully pluggable)
SL 5.08HC/180G

Pin headers in glass-fibre-reinforced plastic with straight wire outlet; optimised for wave soldering. The flange variant (F) can be screwed onto the respective counter piece or the circuit board. There is no need for an extra screw to connect the circuit board when the solder flange (LF) version is used. This also protects the solder points from mechanical strain. All pin headers can be manually coded or ordered pre-coded. HC = High Current.

General ordering data

Type	SL 5.08HC/16/180G 3.2SN ...	Version	Product data	Packaging
Order No.	1149100000	PCB plug-in connector, male header, closed side, THT solder connection, 5.08 mm, Number of poles: 16, 180°, Solder pin length (l): 3.2 mm, tinned, black, Box	IEC: 400 V / 24 A UL: 300 V / 18.5 A	Box
GTIN (EAN)	4032248935017			
Qty.	50 pc(s).			
Type	SL 5.08HC/16/180G 3.2SN ...	Version	Product data	Packaging
Order No.	1147040000	PCB plug-in connector, male header, closed side, THT solder connection, 5.08 mm, Number of poles: 16, 180°, Solder pin length (l): 3.2 mm, tinned, orange, Box	IEC: 400 V / 24 A UL: 300 V / 18.5 A	Box
GTIN (EAN)	4032248934065			
Qty.	50 pc(s).			

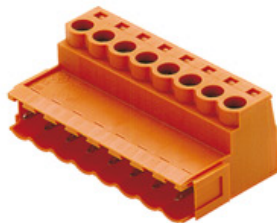
SLS 5.08/180B

Male plugs with clamping-yoke screw wire-connect system. The male plugs provide space for labelling and can be coded.

General ordering data

Type	SLS 5.08/16/180B SN OR ...	Version	Product data	Packaging
Order No.	1627380000	PCB plug-in connector, male plug, 5.08 mm, Number of poles: 16, 180°, Clamping yoke connection, Clamping range, max. : 3.31 mm², UL: 300 V / 14 A / AWG 26 - AWG 12	IEC: 400 V / 21.5 A / 0.2 - 2.5 mm² UL: 300 V / 14 A / AWG 26 - AWG 12	Box
GTIN (EAN)	4008190199890			
Qty.	18 pc(s).			

**OMNIMATE Signal - series BL/SL 5.08
BLZP 5.08HC/16/225 SN OR BX**

Weidmüller Interface GmbH & Co. KG
Klingenbergstraße 26
D-32758 Detmold
Germany
Fon: +49 5231 14-0
Fax: +49 5231 14-292083
www.weidmueller.com

Mating connector (fully pluggable)
SL 5.08HC/180

Pin headers in glass-fibre-reinforced plastic with straight wire outlet; optimised for wave soldering. The flange variant (F) can be screwed onto the respective counter piece or the circuit board. There is no need for an extra screw to connect the circuit board when the solder flange (LF) version is used. This also protects the solder points from mechanical strain. All pin headers can be manually coded or ordered pre-coded. HC = High Current.

General ordering data

Type	SL 5.08HC/16/180 3.2SN ...	Version	Product data	Packaging
Order No.	1146610000	PCB plug-in connector, male header, open side, THT solder connection, 5.08 mm, Number of poles: 16, 180°, Solder pin length (l): 3.2 mm, tinned, orange, Box	IEC: 400 V / 24 A UL: 300 V / 18.5 A	Box
GTIN (EAN)	4032248933518			
Qty.	50 pc(s).			
Type	SL 5.08HC/16/180 3.2SN ...	Version	Product data	Packaging
Order No.	1148410000	PCB plug-in connector, male header, open side, THT solder connection, 5.08 mm, Number of poles: 16, 180°, Solder pin length (l): 3.2 mm, tinned, black, Box	IEC: 400 V / 24 A UL: 300 V / 18.5 A	Box
GTIN (EAN)	4032248934867			
Qty.	50 pc(s).			

SLS 5.08TB RF15

Male plugs with clamping-yoke screw wire-connect system. With clip-on feet for attaching the male plugs on rail. The male plugs provide space for labelling and can be coded.

General ordering data

Type	SLS 5.08/16/180TB RF15 ...	Version	Product data	Packaging
Order No.	1846100000	PCB plug-in connector, male plug, 5.08 mm, Number of poles: 16, 180°, Clamping yoke connection, Clamping range, max. : 3.31 mm², Box	IEC: 400 V / 21.5 A / 0.2 - 2.5 mm² UL: 300 V / 14 A / AWG 26 - AWG 12	Box
GTIN (EAN)	4032248362387			
Qty.	5 pc(s).			

**OMNIMATE Signal - series BL/SL 5.08
BLZP 5.08HC/16/225 SN OR BX**

Weidmüller Interface GmbH & Co. KG
Klingenbergstraße 26
D-32758 Detmold
Germany
Fon: +49 5231 14-0
Fax: +49 5231 14-292083
www.weidmueller.com

Mating connector (fully pluggable)
SL 5.08/90

Male connectors with 90° outlet direction. The solder pin length is optimised for wave flow soldering. The pin headers provide space for labelling and can be coded.

General ordering data

Type	SL 5.08/16/90 3.2SN OR ...	Version	Product data	Packaging
Order No.	1509460000	PCB plug-in connector, male header, open side, THT solder connection, 5.08 mm, Number of poles: 16, 90°, Solder pin length (l): 3.2 mm, tinned, orange, Box	IEC: 400 V / 18 A UL: 300 V / 15 A	Box
GTIN (EAN)	4008190147464			
Qty.	50 pc(s).			

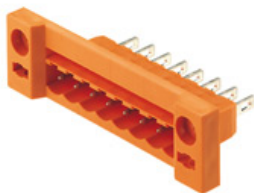
SLDF 5.08

Male connector for through-panel mounting with optional locking function. Internal connection as flat-blade or solder connection. These male connectors provide space for labelling and can be coded.

General ordering data

Type	SLDF 5.08 L/F 16 SN OR ...	Version	Product data	Packaging
Order No.	1599270000	PCB plug-in connector, male header, 5.08 mm, Number of poles: 16, 180°, Flat-blade connection, Solder connection, Box	IEC: 400 V / 15 A UL: 300 V / 10 A	Box
GTIN (EAN)	4008190066826			
Qty.	18 pc(s).			

**OMNIMATE Signal - series BL/SL 5.08
BLZP 5.08HC/16/225 SN OR BX**

Weidmüller Interface GmbH & Co. KG
Klingenbergstraße 26
D-32758 Detmold
Germany
Fon: +49 5231 14-0
Fax: +49 5231 14-292083
www.weidmueller.com

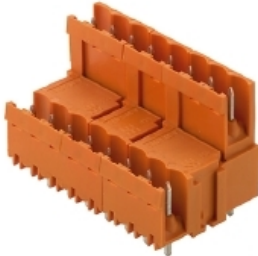
Mating connector (fully pluggable)
SLDV 5.08/180B

Pin headers with solder pin length optimised for wave flow soldering. The male connectors provide space for labelling and can be coded. HC = High Current.

General ordering data

Type	SLD 5.08V/32/180B 3.2SN ...	Version	Product data	Packaging
Order No.	1726880000	PCB plug-in connector, male header, Dovetails for fixing blocks, THT	IEC: 400 V / 14 A	Box
GTIN (EAN)	4032248062775	solder connection, 5.08 mm, Number of poles: 32, 180°, Solder pin	UL: 300 V / 10 A	
Qty.	10 pc(s).	length (l): 3.2 mm, tinned, orange, Box		

SL 5.08/135B



Male connectors with 135° outlet direction. The solder pin length is optimised for wave flow soldering. The pin headers provide space for labelling and can be coded.

General ordering data

Type	SL 5.08/16/135B 3.2SN O ...	Version	Product data	Packaging
Order No.	1605670000	PCB plug-in connector, male header, Dovetails for fixing blocks, THT	IEC: 400 V / 17 A	Box
GTIN (EAN)	4008190153816	solder connection, 5.08 mm, Number of poles: 16, 135°, Solder pin	UL: 300 V / 15 A	
Qty.	50 pc(s).	length (l): 3.2 mm, tinned, orange, Box		

**OMNIMATE Signal - series BL/SL 5.08
BLZP 5.08HC/16/225 SN OR BX**

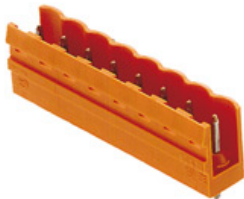
Weidmüller Interface GmbH & Co. KG
Klingenbergstraße 26
D-32758 Detmold
Germany
Fon: +49 5231 14-0
Fax: +49 5231 14-292083
www.weidmueller.com

Mating connector (fully pluggable)
SL 5.08/180

Male connectors with straight outlet direction. The solder pin length is optimised for wave flow soldering. The pin headers provide space for labelling and can be coded.

General ordering data

Type	SL 5.08/16/180 3.2SN OR ...	Version	Product data	Packaging
Order No.	1518660000	PCB plug-in connector, male header, open side, THT solder	IEC: 400 V / 18 A	Box
GTIN (EAN)	4008190083304	connection, 5.08 mm, Number of poles: 16, 180°, Solder pin length	UL: 300 V / 15 A	
Qty.	50 pc(s).	(l): 3.2 mm, tinned, orange, Box		

SLS 5.08/180 SN

Male plugs with clamping-yoke screw wire-connect system. The male plugs provide space for labelling and can be coded.

General ordering data

Type	SLS 5.08/16/180 SN OR BX	Version	Product data	Packaging
Order No.	1627230000	PCB plug-in connector, male plug, 5.08 mm, Number of poles: 16,	IEC: 400 V / 21.5 A / 0.2 - 2.5 mm ²	Box
GTIN (EAN)	4008190199746	180°, Clamping yoke connection, Clamping range, max. : 3.31 mm ² ,	UL: 300 V / 14 A / AWG 26 - AWG 12	
Qty.	18 pc(s).	Box		

**OMNIMATE Signal - series BL/SL 5.08
BLZP 5.08HC/16/225 SN OR BX**

Weidmüller Interface GmbH & Co. KG
 Klingenbergstraße 26
 D-32758 Detmold
 Germany
 Fon: +49 5231 14-0
 Fax: +49 5231 14-292083
 www.weidmueller.com

Mating connector (fully pluggable)
SL 5.08HC/90

Pin headers made from glass-fibre-reinforced plastic with 90° wire outlet; optimised for wave soldering. The flange variant (F) can be screwed onto the respective counter piece or the circuit board. There is no need for an extra screw to connect the circuit board when the solder flange (LF) version is used. This also protects the solder points from mechanical strain. All pin headers can be manually coded or ordered pre-coded. HC = High Current.

General ordering data

Type	SL 5.08HC/16/90 3.2SN O ...	Version	Product data	Packaging
Order No.	1147030000	PCB plug-in connector, male header, open side, THT solder connection, 5.08 mm, Number of poles: 16, 90°, Solder pin length (l): 3.2 mm, tinned, orange, Box	IEC: 400 V / 24 A UL: 300 V / 18.5 A	Box
GTIN (EAN)	4050118051360			
Qty.	50 pc(s).			
Type	SL 5.08HC/16/90 3.2SN B ...	Version	Product data	Packaging
Order No.	1155200000	PCB plug-in connector, male header, open side, THT solder connection, 5.08 mm, Number of poles: 16, 90°, Solder pin length (l): 3.2 mm, tinned, black, Box	IEC: 400 V / 24 A UL: 300 V / 18.5 A	Box
GTIN (EAN)	4050118050677			
Qty.	50 pc(s).			

OMNIMATE Signal - series BL/SL 5.08 BLZP 5.08HC/16/225 SN OR BX

Weidmüller Interface GmbH & Co. KG
 Klingenbergstraße 26
 D-32758 Detmold
 Germany
 Fon: +49 5231 14-0
 Fax: +49 5231 14-292083
 www.weidmueller.com

Accessories

Strain reliefs



For frequent load changes: the "trailer coupling" for plug-in connectors.

The strain relief can do more than just relieve the strain on conductors:

Simply clip onto the plug and

- bundle conductors
- guide cables
- use as a connection and disconnection aid

No damage to the connecting points, clear, tidy wiring and easy to handle.

User advantages: permanent heavy-duty connections for harsh industrial environments and convenient operation ensure improved system availability.

General ordering data

Type	BLZ 5.08 ZE04 BK BX	Version	Product data	Packaging
Order No.	1652130000	PCB plug-in connector, Accessories, Strain relief, black, Number of poles: 4		Box
GTIN (EAN)	4008190401801			
Qty.	50 pc(s).			
Type	BLZ 5.08 ZE08 BK BX	Version	Product data	Packaging
Order No.	1652070000	PCB plug-in connector, Accessories, Strain relief, black, Number of poles: 8		Box
GTIN (EAN)	4008190401740			
Qty.	50 pc(s).			
Type	BLZ 5.08 ZE08 OR BX	Version	Product data	Packaging
Order No.	1652050000	PCB plug-in connector, Accessories, Strain relief, orange, Number of poles: 8		Box
GTIN (EAN)	4008190401726			
Qty.	50 pc(s).			
Type	BLZ 5.08 ZE04 OR BX	Version	Product data	Packaging
Order No.	1652110000	PCB plug-in connector, Accessories, Strain relief, orange, Number of poles: 4		Box
GTIN (EAN)	4008190401788			
Qty.	50 pc(s).			

Crosshead screwdriver Phillips

Crosshead screwdriver, Phillips, SDK PH DIN 5262, ISO 8764/2-PH, output to ISO 8764-PH, ChromTop tip, SoftFinish grip



General ordering data

Type	SDK PH1	Version
Order No.	9008480000	Screwdriver, Blade width (B): 4.5 mm, Blade length: 80 mm
GTIN (EAN)	4032248056477	
Qty.	1 pc(s).	

OMNIMATE Signal - series BL/SL 5.08 BLZP 5.08HC/16/225 SN OR BX

Weidmüller Interface GmbH & Co. KG
 Klingenbergstraße 26
 D-32758 Detmold
 Germany
 Fon: +49 5231 14-0
 Fax: +49 5231 14-292083
 www.weidmueller.com

Accessories

Coding elements



**Only connects what is supposed to be connected:
the right connection at the right place.**

Coding elements and locking devices clearly assign connecting elements during the manufacturing process and operation

The coding elements and locking devices are inserted prior to assembly or during the cable assembly phase. The Weidmüller alternative: configure online using the variant configurator to precode prior to delivery. Incorrect assembly on the circuit board and incorrect plugging of connecting elements is no longer possible. The advantage: no troubleshooting during manufacture and no operational errors by the user.

General ordering data

Type	BLZ/SL KO BK BX	Version	Product data	Packaging
Order No.	1545710000	PCB plug-in connector, Accessories, Coding element, black, Number		Box
GTIN (EAN)	4008190087142	of poles: 1		
Qty.	50 pc(s).			
Type	BLZ/SL KO OR BX	Version	Product data	Packaging
Order No.	1573010000	PCB plug-in connector, Accessories, Coding element, orange, Number		Box
GTIN (EAN)	4008190048396	of poles: 1		
Qty.	100 pc(s).			

Crosshead screwdriver Pozidriv

Crosshead screwdriver, Pozidriv, SDK PZ DIN 5262, ISO 8764/2-PZ, output to ISO 8764/1-PZ, ChromTop tip, SoftFinish grip



General ordering data

Type	SDK PZ1	Version
Order No.	9008530000	Screwdriver, Blade width (B): 4.5 mm, Blade length: 80 mm
GTIN (EAN)	4032248056521	
Qty.	1 pc(s).	

**OMNIMATE Signal - series BL/SL 5.08
BLZP 5.08HC/16/225 SN OR BX**

Weidmüller Interface GmbH & Co. KG
Klingenbergstraße 26
D-32758 Detmold
Germany
Fon: +49 5231 14-0
Fax: +49 5231 14-292083
www.weidmueller.com

Accessories

Slotted screwdriver

Slotted screwdriver with rounded blade SD DIN 5265, ISO 2380/2, output to DIN 5264, ISO 2380/1. ChromTop tip, SoftFinish grip



General ordering data

Type	SDS 0.6X3.5X100	Version
Order No.	9008330000	Screwdriver, Blade width (B): 3.5 mm, Blade length: 100 mm, Blade thickness (A): 0.6 mm
GTIN (EAN)	4032248056286	
Qty.	1 pc(s).	

Slotted screwdriver

VDE insulated slot-head screwdriver, SDI DIN 7437, ISO 2380/2, drive output acc. to DIN 5264, ISO 2380/1. SoftFinish grip



General ordering data

Type	SDIS 0.6X3.5X100	Version
Order No.	9008390000	Screwdriver, Blade width (B): 3.5 mm, Blade length: 100 mm, Blade thickness (A): 0.6 mm
GTIN (EAN)	4032248056354	
Qty.	1 pc(s).	

MASSE OHNE TOLERANZ SIND KEINE PRUEFMASSE
 DIMS. WITHOUT TOLERANCE ARE NOT CONTROL DIMS.

DIE DEUTSCHE VERSION IST VERBINDLICH
 THE GERMAN VERSION IS BINDING

WEITERGABE SOWIE VERVIELFAELTIGUNG DIESES DOKUMENTS, VERWERTUNG UND MITTEILUNG SEINES INHALTS SIND VERBOTEN, SOWEIT NICHT AUSDRUECKLICH GESTATTET.
 ZUWIDERHANDLUNGEN VERPFLICHTEN ZU SCHADENERSATZ. ALLE RECHTE FUER DEN FALL DER PATENT-, GEBRAUCHSMUSTER- ODER GESCHMACKSMUSTEREINTRAGUNG VORBEHALTEN.
 THE REPRODUCTION, DISTRIBUTION AND UTILIZATION OF THIS DOCUMENT AS WELL AS THE COMMUNICATION OF ITS CONTENTS TO OTHERS WITHOUT EXPLICIT AUTHORIZATION IS PROHIBITED.
 OFFENDERS WILL BE HELD LIABLE FOR THE PAYMENT OF DAMAGES. WEIDMUELLER EXCLUSIVELY RESERVES THE RIGHT TO FILE FOR PATENTS, UTILITY MODELS OR DESIGNS.
 © WEIDMUELLER INTERFACE GmbH & Co.KG

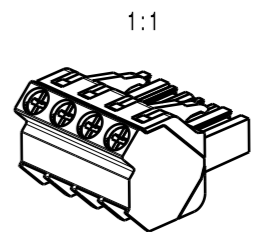
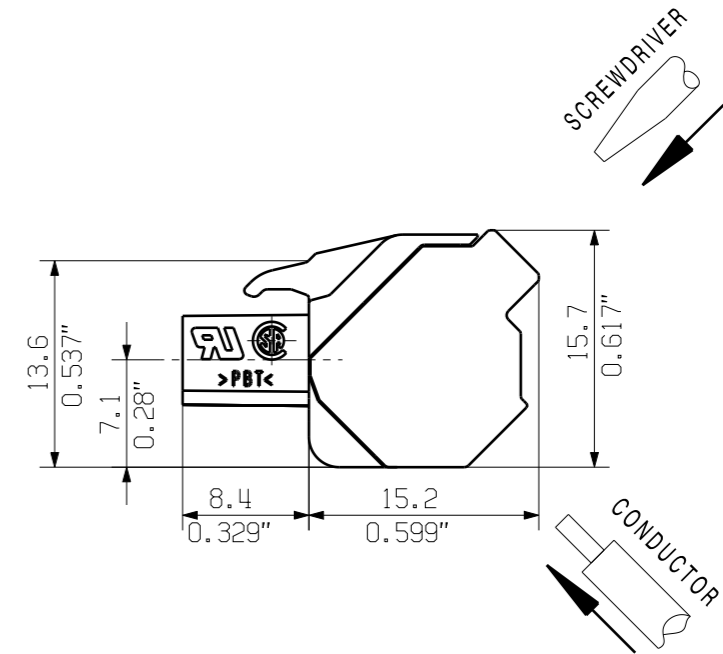
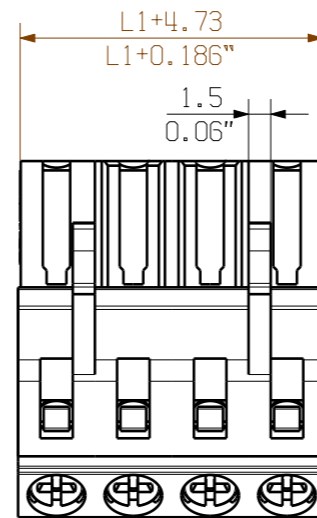
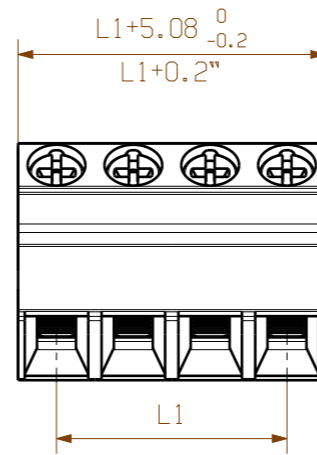

24	116,84	4,600
23	111,76	4,400
22	106,68	4,200
21	101,60	4,000
20	96,52	3,800
19	91,44	3,600
18	86,36	3,400
17	81,28	3,200
16	76,20	3,000
15	71,12	2,800
14	66,04	2,600
13	60,96	2,400
12	55,88	2,200
11	50,80	2,000
10	45,72	1,800
9	40,64	1,600
8	35,56	1,400
7	30,48	1,200
6	25,40	1,000
5	20,32	0,800
4	15,24	0,600
3	10,16	0,400
2	5,08	0,200
n	L1 [mm]	L1 [Inch]

SHOWN: BLZP 5.08HC/04/225

For the mounting of PCBs, it should be noted that the rated data given in the catalogue relates only to the connection elements. The necessary creepage and clearance paths must be observed in connection with the respective applicant in accordance to VDE 0110. The current-carrying capacity and pitch tolerance is to be determined according to DIN IEC 326 part 3 very fine.

Weidmüller connectors are tested to the DIN VDE 0627 standard, and are valid for its field of application. Provided that the connectors are used to the intended purpose, all requirements with respect to the occurring of electrical, mechanical, thermic and corrosive stress will be satisfied.

GENERAL TOLERANCE: DIN ISO 2768-mK		85592/0 04.12.15 HELIS_MA 01		CAT.NO.: .	
		MODIFICATION			
		DATE	NAME	DRAWING NO. C 39789 05	
DRAWN		24.06.2013	HERTEL_S	SHEET 01 OF 03 SHEETS	
RESPONSIBLE			HERTEL_S		
SCALE: 2:1		CHECKED	18.12.2015	BLZP 5.08HC/.../225	
SUPERSEDES: .		APPROVED	LANG_T	BUCHSENLEISTE SOCKET BLOCK	
		PRODUCT FILE: BLZP 5.0X		7157	