

## OMNIMATE Signal - series BL/SL 5.08 BLZP 5.08HC/02/225 SN OR BX

**Weidmüller Interface GmbH & Co. KG**  
Klingenbergstraße 26  
D-32758 Detmold  
Germany  
Fon: +49 5231 14-0  
Fax: +49 5231 14-292083  
www.weidmueller.com

### Product image

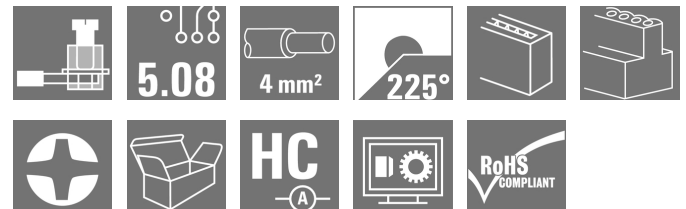

Similar to illustration

Clamping-yoke connection with right-angled (90° or 270°) or angled (225°) outlet direction. The female connectors provide space for labelling and can be coded. Fastened by means of a flange or release latch. They also provide an integrated plus/minus screw, protection against faulty insertion of the wire, and they are delivered with open clamping yokes. HC = High Current.

### General ordering data

Type	BLZP 5.08HC/02/225 SN OR BX
Order No.	<a href="#">1946250000</a>
Version	PCB plug-in connector, female plug, 5.08 mm, Number of poles: 2, 225°, Clamping yoke connection, Clamping range, max. : 4 mm², Box
GTIN (EAN)	4032248621828
Qty.	180 pc(s).
Product data	IEC: 400 V / 17.5 A / 0.2 - 4 mm² UL: 300 V / 15 A / AWG 26 - AWG 12
Packaging	Box

Creation date May 3, 2020 9:44:41 AM CEST

**OMNIMATE Signal - series BL/SL 5.08  
BLZP 5.08HC/02/225 SN OR BX**

**Weidmüller Interface GmbH & Co. KG**  
 Klingenbergstraße 26  
 D-32758 Detmold  
 Germany  
 Fon: +49 5231 14-0  
 Fax: +49 5231 14-292083  
 www.weidmueller.com

**Technical data****Dimensions and weights**

Width	10.16 mm	Width (inches)	0.4 inch
Height	15.7 mm	Height (inches)	0.618 inch
Depth	23.6 mm	Depth (inches)	0.929 inch
Net weight	3.81 g		

**System Parameters**

Product family	OMNIMATE Signal - series BL/SL 5.08	Type of connection	Field connection
Wire connection method	Clamping yoke connection	Pitch in mm (P)	5.08 mm
Pitch in inches (P)	0.2 inch	Conductor outlet direction	225°
Number of poles	2	L1 in mm	5.08 mm
L1 in inches	0.2 inch	Number of rows	1
Pin series quantity	1	Rated cross-section	4 mm <sup>2</sup>
Touch-safe protection acc. to DIN VDE 57 106	Safe from finger touch	Touch-safe protection acc. to DIN VDE 0470	IP 20
Volume resistance	≤ 5mΩ	Can be coded	Yes
Stripping length	7 mm	Tightening torque, min.	0.4 Nm
Tightening torque, max.	0.5 Nm	Clamping screw	M 2.5
Screwdriver blade		Screwdriver blade standard	DIN 5264, ISO 8764/2-PH, ISO 8764/2-PZ
	0.6 x 3.5, PH 1, PZ 1	Plugging force/pole, max.	10 N
Plugging cycles	25		
Pulling force/pole, max.	9 N		

**Material data**

Insulating material	PBT	Colour	orange
Colour chart (similar)	RAL 2000	Insulating material group	IIIa
Comparative Tracking Index (CTI)	≥ 200	Insulation strength	≥ 10 <sup>8</sup> Ω
UL 94 flammability rating	V-0	GWFI	960 °C
Contact material	Copper alloy	Contact surface	tinned
Layer structure of plug contact	4-8 μm Sn hot-dip tinned	Storage temperature, min.	-25 °C
Storage temperature, max.	50 °C	Max. relative humidity during storage	70 %
Operating temperature, min.	-50 °C	Operating temperature, max.	100 °C
Temperature range, installation, min.	-25 °C	Temperature range, installation, max.	100 °C

**Conductors suitable for connection**

Clamping range, min.	0.13 mm <sup>2</sup>	Clamping range, max.	4 mm <sup>2</sup>
Wire connection cross section AWG, min.	AWG 30	Wire connection cross section AWG, max.	AWG 12
Solid, min. H05(07) V-U	0.2 mm <sup>2</sup>	Solid, max. H05(07) V-U	4 mm <sup>2</sup>
Flexible, min. H05(07) V-K	0.2 mm <sup>2</sup>	Flexible, max. H05(07) V-K	4 mm <sup>2</sup>
w. plastic collar ferrule, DIN 46228 pt 4, min.	0.2 mm <sup>2</sup>	w. plastic collar ferrule, DIN 46228 pt 4, max.	2.5 mm <sup>2</sup>
w. wire end ferrule, DIN 46228 pt 1, min.	0.2 mm <sup>2</sup>	w. wire end ferrule, DIN 46228 pt 1, max.	4 mm <sup>2</sup>
Plug gauge in accordance with EN 60999 a x b; ø		Reference text	The outside diameter of the plastic collar should not be larger than the pitch (P). Length of ferrules is to be chosen depending on the product and the rated voltage.
	2.8 mm x 2.4 mm		
Max. clamping range	4 mm <sup>2</sup>		

**OMNIMATE Signal - series BL/SL 5.08  
BLZP 5.08HC/02/225 SN OR BX**

**Weidmüller Interface GmbH & Co. KG**  
 Klingenbergstraße 26  
 D-32758 Detmold  
 Germany  
 Fon: +49 5231 14-0  
 Fax: +49 5231 14-292083  
 www.weidmueller.com



**Technical data****Rated data acc. to IEC**

tested acc. to standard	IEC 60664-1, IEC 61984	Rated current, min. number of poles (Tu=20°C)	17.5 A
Rated current, max. number of poles (Tu=20°C)	14 A	Rated current, min. number of poles (Tu=40°C)	14 A
Rated current, max. number of poles (Tu=40°C)	12 A	Rated voltage for surge voltage class / pollution degree II/2	400 V
Rated voltage for surge voltage class / pollution degree III/2	320 V	Rated voltage for surge voltage class / pollution degree III/3	250 V
Rated impulse voltage for surge voltage class/ pollution degree II/2	4 kV	Rated impulse voltage for surge voltage class/ pollution degree III/2	4 kV
Rated impulse voltage for surge voltage class/ contamination degree III/3	4 kV	Short-time withstand current resistance	3 x 1s with 120 A

**Rated data acc. to CSA**

Institute (CSA)		Certificate No. (CSA)	200039-1121690
Rated voltage (Use group B / CSA)	300 V	Rated voltage (Use group C / CSA)	50 V
Rated voltage (Use group D / CSA)	300 V	Rated current (Use group B / CSA)	15 A
Rated current (Use group D / CSA)	15 A	Wire cross-section, AWG, min.	AWG 30
Wire cross-section, AWG, max.	AWG 12	Reference to approval values	Specifications are maximum values, details - see approval certificate.

**Rated data acc. to UL 1059**

Institute (UR)		Certificate No. (UR)	E60693
Institute (cURus)		Certificate No. (cURus)	E60693
Rated voltage (Use group B / UL 1059)	300 V	Rated voltage (Use group D / UL 1059)	300 V
Rated current (Use group B / UL 1059)	15 A	Rated current (Use group D / UL 1059)	10 A
Wire cross-section, AWG, min.	AWG 26	Wire cross-section, AWG, max.	AWG 12
Reference to approval values	Specifications are maximum values, details - see approval certificate.		

**Packing**

Packaging	Box	VPE length	30 mm
VPE width	135 mm	VPE height	350 mm

**Classifications**

ETIM 6.0	EC002638	ETIM 7.0	EC002638
eClass 9.0	27-44-03-09	eClass 9.1	27-44-03-09
eClass 10.0	27-44-03-09	UNSPSC	30-21-18-01

## Data sheet

### OMNIMATE Signal - series BL/SL 5.08 BLZP 5.08HC/02/225 SN OR BX

**Weidmüller Interface GmbH & Co. KG**  
Klingenbergstraße 26  
D-32758 Detmold  
Germany  
Fon: +49 5231 14-0  
Fax: +49 5231 14-292083  
www.weidmueller.com

## Technical data

### Notes

Notes	<ul style="list-style-type: none"> <li>• Additional colours on request</li> <li>• Gold-plated contact surfaces on request</li> <li>• Rated current related to rated cross-section &amp; min. No. of poles.</li> <li>• Wire end ferrule without plastic collar to DIN 46228/1</li> <li>• Wire end ferrule with plastic collar to DIN 46228/4</li> <li>• P on drawing = pitch</li> <li>• Rated data refer only to the component itself. Clearance and creepage distances to other components are to be designed in accordance with the relevant application standards.</li> </ul>
IPC conformity	Conformity: The products are developed, manufactured and delivered according international recognized standards and norms and comply with the assured properties in the data sheet resp. fulfill decorative properties in accordance with IPC-A-610 "Class 2". Further claims on the products can be evaluated on request.

### Approvals

Approvals



ROHS Conform

### Downloads

Approval/Certificate/Document of Conformity	<a href="#">Declaration of the Manufacturer</a>
Brochure/Catalogue	<a href="#">FL DRIVES EN</a> <a href="#">MB DEVICE MANUF. EN</a> <a href="#">FL DRIVES DE</a> <a href="#">CAT 2 PORTFOLIOGUIDE EN</a> <a href="#">FL BUILDING SAFETY EN</a> <a href="#">FL APPL LED LIGHTING EN</a> <a href="#">FLIndustr.CONTROLS EN</a> <a href="#">FL MACHINE SAFETY EN</a> <a href="#">FL HEATING ELECTER EN</a> <a href="#">FL APPL INVERTER EN</a> <a href="#">FL_BASE_STATION_EN</a> <a href="#">FL ELEVATOR EN</a> <a href="#">FL POWER SUPPLY EN</a> <a href="#">FL 72H SAMPLE SER EN</a> <a href="#">PO OMNIMATE EN</a>
Engineering Data	<a href="#">WSCAD</a>
Engineering Data	<a href="#">STEP</a>

**Data sheet**

**OMNIMATE Signal - series BL/SL 5.08  
BLZP 5.08HC/02/225 SN OR BX**

**Weidmüller Interface GmbH & Co. KG**  
Klingenbergstraße 26  
D-32758 Detmold  
Germany  
Fon: +49 5231 14-0  
Fax: +49 5231 14-292083  
www.weidmueller.com

**Drawings**

**Dimensional drawing**

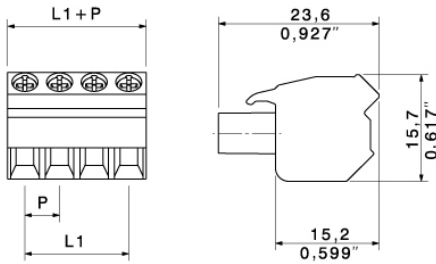

**Graph**

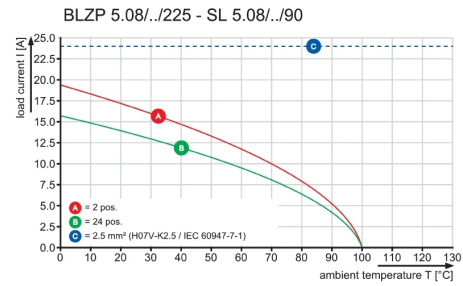

**Graph**

**OMNIMATE Signal - series BL/SL 5.08  
BLZP 5.08HC/02/225 SN OR BX**

**Weidmüller Interface GmbH & Co. KG**  
Klingenbergstraße 26  
D-32758 Detmold  
Germany  
Fon: +49 5231 14-0  
Fax: +49 5231 14-292083  
www.weidmueller.com

**Mating connector (fully pluggable)**
**SL 5.08HC/90B**

Pin headers made from glass-fibre-reinforced plastic with 90° wire outlet; optimised for wave soldering. The flange variant (F) can be screwed onto the respective counter piece or the circuit board. There is no need for an extra screw to connect the circuit board when the solder flange (LF) version is used. This also protects the solder points from mechanical strain. All pin headers can be manually coded or ordered pre-coded. HC = High Current.

**General ordering data**

Type	SL 5.08HC/02/90B 3.2SN ...	Version	Product data	Packaging
Order No.	<a href="#">1155580000</a>	PCB plug-in connector, male header, Dovetails for fixing blocks, THT	IEC: 400 V / 24 A	Box
GTIN (EAN)	4050118050356	solder connection, 5.08 mm, Number of poles: 2, 90°, Solder pin	UL: 300 V / 18.5 A	
Qty.	100 pc(s).	length (l): 3.2 mm, tinned, black, Box		
Type	SL 5.08HC/02/90B 3.2SN ...	Version	Product data	Packaging
Order No.	<a href="#">1148030000</a>	PCB plug-in connector, male header, Dovetails for fixing blocks, THT	IEC: 400 V / 24 A	Box
GTIN (EAN)	4050118051049	solder connection, 5.08 mm, Number of poles: 2, 90°, Solder pin	UL: 300 V / 18.5 A	
Qty.	100 pc(s).	length (l): 3.2 mm, tinned, orange, Box		

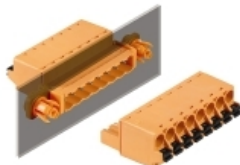
**SLF 5.08/180DF SN**

Male plug with PUSH IN wire connection and straight outlet direction, when used with BLF 5.08HC as wire-to-wire application for panel feed-through. The male plugs provide space for labelling and can be coded.

**General ordering data**

Type	SLF 5.08/02/180DF SN OR ...	Version	Product data	Packaging
Order No.	<a href="#">1353580000</a>	PCB plug-in connector, male plug, 5.08 mm, Number of poles: 2,	IEC: 400 V / 25.9 A / 0.2 - 2.5 mm <sup>2</sup>	Box
GTIN (EAN)	4050118156430	180°, PUSH IN, Spring connection, Clamping range, max.: 3.31 mm <sup>2</sup> , UL: 300 V / 14 A / AWG 26 - AWG 12		
Qty.	54 pc(s).	Box		

**OMNIMATE Signal - series BL/SL 5.08  
BLZP 5.08HC/02/225 SN OR BX**

**Weidmüller Interface GmbH & Co. KG**  
Klingenbergstraße 26  
D-32758 Detmold  
Germany  
Fon: +49 5231 14-0  
Fax: +49 5231 14-292083  
www.weidmueller.com

**Mating connector (fully pluggable)**
**SLT 5.08B**

Male plugs with screw TOP wire connection. The male plug provides space for labelling and can be coded.

**General ordering data**

Type	SLT 5.08/02/180B SN OR ...	Version	Product data	Packaging
Order No.	<a href="#">1611710000</a>	PCB plug-in connector, male plug, 5.08 mm, Number of poles: 2,	IEC: 400 V / 16 A / 0.2 - 2.5 mm <sup>2</sup>	Box
GTIN (EAN)	4008190192594	180°, TOP connection, Clamping range, max. : 2.5 mm <sup>2</sup> , Box	UL: 300 V / 15 A / AWG 26 - AWG 14	
Qty.	100 pc(s).			

**SLDV 5.08/90B**

Pin headers with solder pin length optimised for wave flow soldering. The male connectors provide space for labelling and can be coded. HC = High Current.

**General ordering data**

Type	SLD 5.08V/04/90B 3.2 SN ...	Version	Product data	Packaging
Order No.	<a href="#">1726280000</a>	PCB plug-in connector, male header, Dovetails for fixing blocks, THT	IEC: 400 V / 17 A	Box
GTIN (EAN)	4032248061259	solder connection, 5.08 mm, Number of poles: 4, 90°, Solder pin	UL: 300 V / 10 A	
Qty.	50 pc(s).	length (l): 3.2 mm, tinned, orange, Box		

**OMNIMATE Signal - series BL/SL 5.08  
BLZP 5.08HC/02/225 SN OR BX**

**Weidmüller Interface GmbH & Co. KG**  
Klingenbergstraße 26  
D-32758 Detmold  
Germany  
Fon: +49 5231 14-0  
Fax: +49 5231 14-292083  
www.weidmueller.com

**Mating connector (fully pluggable)**
**SL 5.08/90B**

Male connectors with 90° outlet direction. The solder pin length is optimised for wave flow soldering. The pin headers provide space for labelling and can be coded.

**General ordering data**

Type	SL 5.08/02/90B 3.2SN BK ...	Version	Product data	Packaging
Order No.	<a href="#">1510310000</a>	PCB plug-in connector, male header, Dovetails for fixing blocks, THT	IEC: 400 V / 18 A	Box
GTIN (EAN)	4008190477684	solder connection, 5.08 mm, Number of poles: 2, 90°, Solder pin	UL: 300 V / 15 A	
Qty.	100 pc(s).	length (l): 3.2 mm, tinned, black, Box		
Type	SL 5.08/02/90B 3.2SN OR ...	Version	Product data	Packaging
Order No.	<a href="#">1510360000</a>	PCB plug-in connector, male header, Dovetails for fixing blocks, THT	IEC: 400 V / 18 A	Box
GTIN (EAN)	4008190180188	solder connection, 5.08 mm, Number of poles: 2, 90°, Solder pin	UL: 300 V / 15 A	
Qty.	100 pc(s).	length (l): 3.2 mm, tinned, orange, Box		

**SL 5.08/135**

Male connectors with 135° outlet direction. The solder pin length is optimised for wave flow soldering. The pin headers provide space for labelling and can be coded.

**General ordering data**

Type	SL 5.08/02/135 3.2SN OR ...	Version	Product data	Packaging
Order No.	<a href="#">1603060000</a>	PCB plug-in connector, male header, open side, THT solder	IEC: 400 V / 17 A	Box
GTIN (EAN)	4008190095512	connection, 5.08 mm, Number of poles: 2, 135°, Solder pin length (l):	UL: 300 V / 15 A	
Qty.	100 pc(s).	3.2 mm, tinned, orange, Box		



**OMNIMATE Signal - series BL/SL 5.08  
BLZP 5.08HC/02/225 SN OR BX**

**Weidmüller Interface GmbH & Co. KG**  
Klingenbergstraße 26  
D-32758 Detmold  
Germany  
Fon: +49 5231 14-0  
Fax: +49 5231 14-292083  
www.weidmueller.com

**Mating connector (fully pluggable)**
**SL-SMT 5.08/270GL Tape**

High-temperature-resistant, straight, open pin header. Packed in box or tape. On tape and with 1.5 mm solder pin, optimised for automatic assembly. 3.2 mm solder pin suitable for reflow and wave soldering. The pin headers provide space for labelling and can be coded. HC = High Current.

**General ordering data**

Type	SL-SMT 5.08/02/270GL 3. ...	Version	Product data	Packaging
Order No.	<a href="#">1877880000</a>	PCB plug-in connector, male header, closed side, THT/THR solder connection, 5.08 mm, Number of poles: 2, 270°, Solder pin length (l): 3.2 mm, tinned, black, Tape	IEC: 400 V / 27.5 A UL: 300 V / 18.5 A	Tape
GTIN (EAN)	4032248468553			
Qty.	350 pc(s).			
Type	SL-SMT 5.08HC/02/270GL ...	Version	Product data	Packaging
Order No.	<a href="#">1877740000</a>	PCB plug-in connector, male header, closed side, THT/THR solder connection, 5.08 mm, Number of poles: 2, 270°, Solder pin length (l): 1.5 mm, tinned, black, Tape	IEC: 400 V / 27.5 A UL: 300 V / 18.5 A	Tape
GTIN (EAN)	4032248467891			
Qty.	350 pc(s).			

**SLDV 5.08/90**

Pin headers with solder pin length optimised for wave flow soldering. The male connectors provide space for labelling and can be coded. HC = High Current.

**General ordering data**

Type	SLD 5.08V/04/90 3.2 SN ...	Version	Product data	Packaging
Order No.	<a href="#">1725170000</a>	PCB plug-in connector, male header, open side, THT solder connection, 5.08 mm, Number of poles: 4, 90°, Solder pin length (l): 3.2 mm, tinned, orange, Box	IEC: 400 V / 17 A UL: 300 V / 10 A	Box
GTIN (EAN)	4032248060573			
Qty.	50 pc(s).			

**OMNIMATE Signal - series BL/SL 5.08  
BLZP 5.08HC/02/225 SN OR BX**

**Weidmüller Interface GmbH & Co. KG**  
Klingenbergstraße 26  
D-32758 Detmold  
Germany  
Fon: +49 5231 14-0  
Fax: +49 5231 14-292083  
www.weidmueller.com

**Mating connector (fully pluggable)**
**SL 5.08HC/180B**

Pin headers in glass-fibre-reinforced plastic with straight wire outlet; optimised for wave soldering. The flange variant (F) can be screwed onto the respective counter piece or the circuit board. There is no need for an extra screw to connect the circuit board when the solder flange (LF) version is used. This also protects the solder points from mechanical strain. All pin headers can be manually coded or ordered pre-coded. HC = High Current.

**General ordering data**

Type	SL 5.08HC/02/180B 3.2SN ...	Version	Product data	Packaging
Order No.	<a href="#">1149400000</a>	PCB plug-in connector, male header, Dovetails for fixing blocks, THT	IEC: 400 V / 24 A	Box
GTIN (EAN)	4032248934669	solder connection, 5.08 mm, Number of poles: 2, 180°, Solder pin	UL: 300 V / 18.5 A	
Qty.	100 pc(s).	length (l): 3.2 mm, tinned, black, Box		
Type	SL 5.08HC/02/180B 3.2SN ...	Version	Product data	Packaging
Order No.	<a href="#">1147300000</a>	PCB plug-in connector, male header, Dovetails for fixing blocks, THT	IEC: 400 V / 24 A	Box
GTIN (EAN)	4032248933839	solder connection, 5.08 mm, Number of poles: 2, 180°, Solder pin	UL: 300 V / 18.5 A	
Qty.	100 pc(s).	length (l): 3.2 mm, tinned, orange, Box		

**SL-SMT 5.08/180G Box**

High-temperature-resistant pin header, packed in box or tape. On tape, with 1.5 mm solder pin, optimised for automatic assembly. 3.2 mm solder pin suitable for reflow and wave soldering. The pin headers provide space for labelling and can be coded. HC = High Current.

**General ordering data**

Type	SL-SMT 5.08HC/02/180G 1 ...	Version	Product data	Packaging
Order No.	<a href="#">1775922001</a>	PCB plug-in connector, male header, closed side, THT/THR solder	IEC: 400 V / 27.5 A	Box
GTIN (EAN)	4032248158911	connection, 5.08 mm, Number of poles: 2, 180°, Solder pin length (l):	UL: 300 V / 18.5 A	
Qty.	100 pc(s).	1.5 mm, tinned, black, Box		
Type	SL-SMT 5.08HC/02/180G 3 ...	Version	Product data	Packaging
Order No.	<a href="#">1838210000</a>	PCB plug-in connector, male header, closed side, THT/THR solder	IEC: 400 V / 27.5 A	Box
GTIN (EAN)	4032248348275	connection, 5.08 mm, Number of poles: 2, 180°, Solder pin length (l):	UL: 300 V / 18.5 A	
Qty.	100 pc(s).	3.2 mm, tinned, black, Box		

**OMNIMATE Signal - series BL/SL 5.08  
BLZP 5.08HC/02/225 SN OR BX**

**Weidmüller Interface GmbH & Co. KG**  
Klingenbergstraße 26  
D-32758 Detmold  
Germany  
Fon: +49 5231 14-0  
Fax: +49 5231 14-292083  
www.weidmueller.com

**Mating connector (fully pluggable)**
**SL-SMT 5.08HC/90 Tape**

High-temperature-resistant, 90° angled, open male header. Packed in box or tape. On tape, with 1.5 mm solder pin, optimised for automatic assembly. 3.2 mm solder pin suitable for reflow and wave soldering. The pin headers provide space for labelling and can be coded. HC = High Current.

**General ordering data**

Type	SL-SMT 5.08HC/02/90 1.5 ...	Version	Product data	Packaging
Order No.	<a href="#">1821160000</a>	PCB plug-in connector, male header, open side, THT/THR solder connection, 5.08 mm, Number of poles: 2, 90°, Solder pin length (l): 1.5 mm, tinned, black, Tape	IEC: 400 V / 27.5 A UL: 300 V / 18.5 A	Tape
GTIN (EAN)	4032248319800			
Qty.	350 pc(s).			

**SL-SMT 5.08/180 Box**

High-temperature-resistant, straight, open pin header. Packed in box or tape. On tape and with 1.5 mm solder pin, optimised for automatic assembly. 3.2 mm solder pin suitable for reflow and wave soldering. The pin headers provide space for labelling and can be coded. HC = High Current.

**General ordering data**

Type	SL-SMT 5.08HC/02/180 3. ...	Version	Product data	Packaging
Order No.	<a href="#">1837980000</a>	PCB plug-in connector, male header, open side, THT/THR solder connection, 5.08 mm, Number of poles: 2, 180°, Solder pin length (l): 3.2 mm, tinned, black, Box	IEC: 400 V / 27.5 A UL: 300 V / 18.5 A	Box
GTIN (EAN)	4032248348046			
Qty.	100 pc(s).			
Type	SL-SMT 5.08HC/02/180 1. ...	Version	Product data	Packaging
Order No.	<a href="#">1775522001</a>	PCB plug-in connector, male header, open side, THT/THR solder connection, 5.08 mm, Number of poles: 2, 180°, Solder pin length (l): 1.5 mm, tinned, black, Box	IEC: 400 V / 27.5 A UL: 300 V / 18.5 A	Box
GTIN (EAN)	4032248157549			
Qty.	100 pc(s).			

**OMNIMATE Signal - series BL/SL 5.08  
BLZP 5.08HC/02/225 SN OR BX**

**Weidmüller Interface GmbH & Co. KG**  
Klingenbergstraße 26  
D-32758 Detmold  
Germany  
Fon: +49 5231 14-0  
Fax: +49 5231 14-292083  
www.weidmueller.com

**Mating connector (fully pluggable)**
**SLDV 5.08/180**

Pin headers with solder pin length optimised for wave flow soldering. The male connectors provide space for labelling and can be coded. HC = High Current.

**General ordering data**

Type	SLD 5.08V/04/180 3.2SN ...	Version	Product data	Packaging
Order No.	<a href="#">1725650000</a>	PCB plug-in connector, male header, open side, THT solder	IEC: 400 V / 14 A	Box
GTIN (EAN)	4032248061945	connection, 5.08 mm, Number of poles: 4, 180°, Solder pin length (l):	UL: 300 V / 10 A	
Qty.	50 pc(s).	3.2 mm, tinned, orange, Box		

**SL-SMT 5.08/180 Tape**



High-temperature-resistant, straight, open pin header. Packed in box or tape. On tape and with 1.5 mm solder pin, optimised for automatic assembly. 3.2 mm solder pin suitable for reflow and wave soldering. The pin headers provide space for labelling and can be coded. HC = High Current.

**General ordering data**

Type	SL-SMT 5.08HC/02/180 1. ...	Version	Product data	Packaging
Order No.	<a href="#">1821100000</a>	PCB plug-in connector, male header, open side, THT/THR solder	IEC: 400 V / 27.5 A	Tape
GTIN (EAN)	4032248319749	connection, 5.08 mm, Number of poles: 2, 180°, Solder pin length (l):	UL: 300 V / 18.5 A	
Qty.	250 pc(s).	1.5 mm, tinned, black, Tape		

**OMNIMATE Signal - series BL/SL 5.08  
BLZP 5.08HC/02/225 SN OR BX**

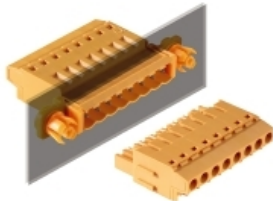
**Weidmüller Interface GmbH & Co. KG**  
Klingenbergstraße 26  
D-32758 Detmold  
Germany  
Fon: +49 5231 14-0  
Fax: +49 5231 14-292083  
www.weidmueller.com

**Mating connector (fully pluggable)**
**SLT 5.08/180DF SN**

Male plugs with screw TOP wire connection. The male plug provides space for labelling and can be coded.

**General ordering data**

Type	SLT 5.08/02/180DF SN OR ...	Version	Product data	Packaging
Order No.	<a href="#">1353350000</a>	PCB plug-in connector, male plug, 5.08 mm, Number of poles: 2,	IEC: 400 V / 16 A / 0.2 - 2.5 mm <sup>2</sup>	Box
GTIN (EAN)	4050118156645	180°, TOP connection, Clamping range, max.: 2.5 mm <sup>2</sup> , Box	UL: 300 V / 15 A / AWG 26 - AWG 14	
Qty.	54 pc(s).			

**SL-SMT 5.08HC/90 Box**

High-temperature-resistant, 90° angled, open male header. Packed in box or tape. On tape, with 1.5 mm solder pin, optimised for automatic assembly. 3.2 mm solder pin suitable for reflow and wave soldering. The pin headers provide space for labelling and can be coded. HC = High Current.

**General ordering data**

Type	SL-SMT 5.08HC/02/90 3.2 ...	Version	Product data	Packaging
Order No.	<a href="#">1779950000</a>	PCB plug-in connector, male header, open side, THT/THR solder	IEC: 400 V / 27.5 A	Box
GTIN (EAN)	4032248165278	connection, 5.08 mm, Number of poles: 2, 90°, Solder pin length (l):	UL: 300 V / 18.5 A	
Qty.	100 pc(s).	3.2 mm, tinned, black, Box		
Type	SL-SMT 5.08HC/02/90 1.5 ...	Version	Product data	Packaging
Order No.	<a href="#">1774762001</a>	PCB plug-in connector, male header, open side, THT/THR solder	IEC: 400 V / 27.5 A	Box
GTIN (EAN)	4032248155699	connection, 5.08 mm, Number of poles: 2, 90°, Solder pin length (l):	UL: 300 V / 18.5 A	
Qty.	100 pc(s).	1.5 mm, tinned, black, Box		

**OMNIMATE Signal - series BL/SL 5.08  
BLZP 5.08HC/02/225 SN OR BX**

**Weidmüller Interface GmbH & Co. KG**  
Klingenbergstraße 26  
D-32758 Detmold  
Germany  
Fon: +49 5231 14-0  
Fax: +49 5231 14-292083  
www.weidmueller.com

**Mating connector (fully pluggable)**
**SL 5.08/180B**

Male connectors with straight outlet direction. The solder pin length is optimised for wave flow soldering. The pin headers provide space for labelling and can be coded.

**General ordering data**

Type	SL 5.08/02/180B 3.2SN O ...	Version	Product data	Packaging
Order No.	<a href="#">1519560000</a>	PCB plug-in connector, male header, Dovetails for fixing blocks, THT	IEC: 400 V / 18 A	Box
GTIN (EAN)	4008190083892	solder connection, 5.08 mm, Number of poles: 2, 180°, Solder pin	UL: 300 V / 15 A	
Qty.	100 pc(s).	length (l): 3.2 mm, tinned, orange, Box		

**SL-SMT 5.08/180G Tape**



High-temperature-resistant pin header, packed in box or tape. On tape, with 1.5 mm solder pin, optimised for automatic assembly. 3.2 mm solder pin suitable for reflow and wave soldering. The pin headers provide space for labelling and can be coded. HC = High Current.

**General ordering data**

Type	SL-SMT 5.08HC/02/180G 1 ...	Version	Product data	Packaging
Order No.	<a href="#">1820170000</a>	PCB plug-in connector, male header, closed side, THT/THR solder	IEC: 400 V / 27.5 A	Tape
GTIN (EAN)	4032248315680	connection, 5.08 mm, Number of poles: 2, 180°, Solder pin length (l):	UL: 300 V / 18.5 A	
Qty.	250 pc(s).	1.5 mm, tinned, black, Tape		

**OMNIMATE Signal - series BL/SL 5.08  
BLZP 5.08HC/02/225 SN OR BX**

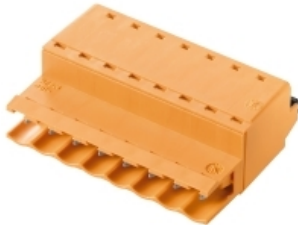
**Weidmüller Interface GmbH & Co. KG**  
Klingenbergstraße 26  
D-32758 Detmold  
Germany  
Fon: +49 5231 14-0  
Fax: +49 5231 14-292083  
www.weidmueller.com

**Mating connector (fully pluggable)**
**SLF 5.08/180 SN**

Male plug with PUSH IN wire connection and straight outlet direction, when used with BLF 5.08HC as wire-to-wire application for panel feed-through. The male plugs provide space for labelling and can be coded.

**General ordering data**

Type	SLF 5.08/02/180 SN BK BX	Version	Product data	Packaging
Order No.	<a href="#">1335560000</a>	PCB plug-in connector, male plug, 5.08 mm, Number of poles: 2,	IEC: 400 V / 25.9 A / 0.2 - 2.5 mm <sup>2</sup>	Box
GTIN (EAN)	4050118138740	180°, PUSH IN, Spring connection, Clamping range, max.: 3.31 mm <sup>2</sup> , UL: 300 V / 14 A / AWG 26 - AWG 12		
Qty.	180 pc(s).	Box		
Type	SLF 5.08/02/180 SN OR BX	Version	Product data	Packaging
Order No.	<a href="#">1335330000</a>	PCB plug-in connector, male plug, 5.08 mm, Number of poles: 2,	IEC: 400 V / 25.9 A / 0.2 - 2.5 mm <sup>2</sup>	Box
GTIN (EAN)	4050118138559	180°, PUSH IN, Spring connection, Clamping range, max.: 3.31 mm <sup>2</sup> , UL: 300 V / 14 A / AWG 26 - AWG 12		
Qty.	180 pc(s).	Box		

**SL-SMT 5.08HC/90G Box**

High-temperature-resistant pin header, packed in box or tape. On tape, with 1.5 mm solder pin, optimised for automatic assembly. 3.2 mm solder pin suitable for reflow and wave soldering. The pin headers provide space for labelling and can be coded. HC = High Current.

**General ordering data**

Type	SL-SMT 5.08HC/02/90G 1. ...	Version	Product data	Packaging
Order No.	<a href="#">1775002001</a>	PCB plug-in connector, male header, closed side, THT/THR solder	IEC: 400 V / 27.5 A	Box
GTIN (EAN)	4032248156023	connection, 5.08 mm, Number of poles: 2, 90°, Solder pin length (l):	UL: 300 V / 18.5 A	
Qty.	100 pc(s).	1.5 mm, tinned, black, Box		
Type	SL-SMT 5.08HC/02/90G 3. ...	Version	Product data	Packaging
Order No.	<a href="#">1780180000</a>	PCB plug-in connector, male header, closed side, THT/THR solder	IEC: 400 V / 27.5 A	Box
GTIN (EAN)	4032248165506	connection, 5.08 mm, Number of poles: 2, 90°, Solder pin length (l):	UL: 300 V / 18.5 A	
Qty.	100 pc(s).	3.2 mm, tinned, black, Box		

**OMNIMATE Signal - series BL/SL 5.08  
BLZP 5.08HC/02/225 SN OR BX**

**Weidmüller Interface GmbH & Co. KG**  
Klingenbergstraße 26  
D-32758 Detmold  
Germany  
Fon: +49 5231 14-0  
Fax: +49 5231 14-292083  
www.weidmueller.com

**Mating connector (fully pluggable)**
**SL 5.08HC/180G**

Pin headers in glass-fibre-reinforced plastic with straight wire outlet; optimised for wave soldering. The flange variant (F) can be screwed onto the respective counter piece or the circuit board. There is no need for an extra screw to connect the circuit board when the solder flange (LF) version is used. This also protects the solder points from mechanical strain. All pin headers can be manually coded or ordered pre-coded. HC = High Current.

**General ordering data**

Type	SL 5.08HC/02/180G 3.2SN ...	Version	Product data	Packaging
Order No.	<a href="#">1146730000</a>	PCB plug-in connector, male header, closed side, THT solder connection, 5.08 mm, Number of poles: 2, 180°, Solder pin length (l): 3.2 mm, tinned, orange, Box	IEC: 400 V / 24 A UL: 300 V / 18.5 A	Box
GTIN (EAN)	4032248108688			
Qty.	100 pc(s).			
Type	SL 5.08HC/02/180G 3.2SN ...	Version	Product data	Packaging
Order No.	<a href="#">1148630000</a>	PCB plug-in connector, male header, closed side, THT solder connection, 5.08 mm, Number of poles: 2, 180°, Solder pin length (l): 3.2 mm, tinned, black, Box	IEC: 400 V / 24 A UL: 300 V / 18.5 A	Box
GTIN (EAN)	4032248934409			
Qty.	100 pc(s).			

**SLF 5.08/180B SN**

Male plug with PUSH IN wire connection and straight outlet direction, when used with BLF 5.08HC as wire-to-wire application for panel feed-through The male plugs provide space for labelling and can be coded.

**General ordering data**

Type	SLF 5.08/02/180B SN BK ...	Version	Product data	Packaging
Order No.	<a href="#">1335770000</a>	PCB plug-in connector, male plug, 5.08 mm, Number of poles: 2, 180°, PUSH IN, Spring connection, Clamping range, max.: 3.31 mm <sup>2</sup> , UL: 300 V / 14 A / AWG 26 - AWG 12	IEC: 400 V / 25.9 A / 0.2 - 2.5 mm <sup>2</sup> UL: 300 V / 14 A / AWG 26 - AWG 12	Box
GTIN (EAN)	4050118140590			
Qty.	150 pc(s).	Box		
Type	SLF 5.08/02/180B SN OR ...	Version	Product data	Packaging
Order No.	<a href="#">1335440000</a>	PCB plug-in connector, male plug, 5.08 mm, Number of poles: 2, 180°, PUSH IN, Spring connection, Clamping range, max.: 3.31 mm <sup>2</sup> , UL: 300 V / 14 A / AWG 26 - AWG 12	IEC: 400 V / 25.9 A / 0.2 - 2.5 mm <sup>2</sup> UL: 300 V / 14 A / AWG 26 - AWG 12	Box
GTIN (EAN)	4050118138832			
Qty.	150 pc(s).	Box		



**OMNIMATE Signal - series BL/SL 5.08  
BLZP 5.08HC/02/225 SN OR BX**

**Weidmüller Interface GmbH & Co. KG**  
Klingenbergstraße 26  
D-32758 Detmold  
Germany  
Fon: +49 5231 14-0  
Fax: +49 5231 14-292083  
www.weidmueller.com

**Mating connector (fully pluggable)**
**SLS 5.08/180B**

Male plugs with clamping-yoke screw wire-connect system. The male plugs provide space for labelling and can be coded.

**General ordering data**

Type	SLS 5.08/02/180B SN OR ...	Version	Product data	Packaging
Order No.	<a href="#">1627240000</a>	PCB plug-in connector, male plug, 5.08 mm, Number of poles: 2,	IEC: 400 V / 21.5 A / 0.2 - 2.5 mm <sup>2</sup>	Box
GTIN (EAN)	4008190199753	180°, Clamping yoke connection, Clamping range, max. : 3.31 mm <sup>2</sup> ,	UL: 300 V / 14 A / AWG 26 - AWG 12	
Qty.	150 pc(s).	Box		

**SL 5.08HC/180**

Pin headers in glass-fibre-reinforced plastic with straight wire outlet; optimised for wave soldering. The flange variant (F) can be screwed onto the respective counter piece or the circuit board. There is no need for an extra screw to connect the circuit board when the solder flange (LF) version is used. This also protects the solder points from mechanical strain. All pin headers can be manually coded or ordered pre-coded. HC = High Current.

**General ordering data**

Type	SL 5.08HC/02/180 3.2SN ...	Version	Product data	Packaging
Order No.	<a href="#">1148080000</a>	PCB plug-in connector, male header, open side, THT solder	IEC: 400 V / 24 A	Box
GTIN (EAN)	4032248934386	connection, 5.08 mm, Number of poles: 2, 180°, Solder pin length (l):	UL: 300 V / 18.5 A	
Qty.	100 pc(s).	3.2 mm, tinned, black, Box		
Type	SL 5.08HC/02/180 3.2SN ...	Version	Product data	Packaging
Order No.	<a href="#">1146320000</a>	PCB plug-in connector, male header, open side, THT solder	IEC: 400 V / 24 A	Box
GTIN (EAN)	4032248108916	connection, 5.08 mm, Number of poles: 2, 180°, Solder pin length (l):	UL: 300 V / 18.5 A	
Qty.	100 pc(s).	3.2 mm, tinned, orange, Box		

**OMNIMATE Signal - series BL/SL 5.08  
BLZP 5.08HC/02/225 SN OR BX**

**Weidmüller Interface GmbH & Co. KG**  
Klingenbergstraße 26  
D-32758 Detmold  
Germany  
Fon: +49 5231 14-0  
Fax: +49 5231 14-292083  
www.weidmueller.com

**Mating connector (fully pluggable)**
**SL-SMT 5.08/270GH Tape**

High-temperature-resistant, straight, open pin header. Packed in box or tape. On tape and with 1.5 mm solder pin, optimised for automatic assembly. 3.2 mm solder pin suitable for reflow and wave soldering. The pin headers provide space for labelling and can be coded. HC = High Current.

**General ordering data**

Type	SL-SMT 5.08HC/02/270GH ...	Version	Product data	Packaging
Order No.	<a href="#">1877560000</a>	PCB plug-in connector, male header, closed side, THT/THR solder connection, 5.08 mm, Number of poles: 2, 270°, Solder pin length (l): 1.5 mm, tinned, black, Tape	IEC: 400 V / 27.5 A UL: 300 V / 18.5 A	Tape
GTIN (EAN)	4032248468188			
Qty.	335 pc(s).			
Type	SL-SMT 5.08HC/02/270GH ...	Version	Product data	Packaging
Order No.	<a href="#">1877810000</a>	PCB plug-in connector, male header, closed side, THT/THR solder connection, 5.08 mm, Number of poles: 2, 270°, Solder pin length (l): 3.2 mm, tinned, black, Tape	IEC: 400 V / 27.5 A UL: 300 V / 18.5 A	Tape
GTIN (EAN)	4032248468461			
Qty.	335 pc(s).			

**SL-SMT 5.08HC/90G Tape**

High-temperature-resistant pin header, packed in box or tape. On tape, with 1.5 mm solder pin, optimised for automatic assembly. 3.2 mm solder pin suitable for reflow and wave soldering. The pin headers provide space for labelling and can be coded. HC = High Current.

**General ordering data**

Type	SL-SMT 5.08HC/02/90G 1. ...	Version	Product data	Packaging
Order No.	<a href="#">1821140000</a>	PCB plug-in connector, male header, closed side, THT/THR solder connection, 5.08 mm, Number of poles: 2, 90°, Solder pin length (l): 1.5 mm, tinned, black, Tape	IEC: 400 V / 27.5 A UL: 300 V / 18.5 A	Tape
GTIN (EAN)	4032248319787			
Qty.	350 pc(s).			

**OMNIMATE Signal - series BL/SL 5.08  
BLZP 5.08HC/02/225 SN OR BX**

**Weidmüller Interface GmbH & Co. KG**  
Klingenbergstraße 26  
D-32758 Detmold  
Germany  
Fon: +49 5231 14-0  
Fax: +49 5231 14-292083  
www.weidmueller.com

**Mating connector (fully pluggable)**
**SL 5.08/90**

Male connectors with 90° outlet direction. The solder pin length is optimised for wave flow soldering. The pin headers provide space for labelling and can be coded.

**General ordering data**

Type	SL 5.08/02/90 3.2SN OR ...	Version	Product data	Packaging
Order No.	<a href="#">1508060000</a>	PCB plug-in connector, male header, open side, THT solder connection, 5.08 mm, Number of poles: 2, 90°, Solder pin length (l): 3.2 mm, tinned, orange, Box	IEC: 400 V / 18 A UL: 300 V / 15 A	Box
GTIN (EAN)	4008190189006			
Qty.	100 pc(s).			

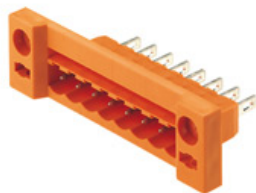
**SLDF 5.08**

Male connector for through-panel mounting with optional locking function. Internal connection as flat-blade or solder connection. These male connectors provide space for labelling and can be coded.

**General ordering data**

Type	SLDF 5.08 L/F 2 SN BK BX	Version	Product data	Packaging
Order No.	<a href="#">1635740000</a>	PCB plug-in connector, male header, 5.08 mm, Number of poles: 2, 180°, Flat-blade connection, Solder connection, Box	IEC: 400 V / 15 A UL: 300 V / 10 A	Box
GTIN (EAN)	4008190264161			
Qty.	60 pc(s).			
Type	SLDF 5.08 L/F 2 SN OR BX	Version	Product data	Packaging
Order No.	<a href="#">1599130000</a>	PCB plug-in connector, male header, 5.08 mm, Number of poles: 2, 180°, Flat-blade connection, Solder connection, Box	IEC: 400 V / 15 A UL: 300 V / 10 A	Box
GTIN (EAN)	4008190175931			
Qty.	60 pc(s).			

**OMNIMATE Signal - series BL/SL 5.08  
BLZP 5.08HC/02/225 SN OR BX**

**Weidmüller Interface GmbH & Co. KG**  
Klingenbergstraße 26  
D-32758 Detmold  
Germany  
Fon: +49 5231 14-0  
Fax: +49 5231 14-292083  
www.weidmueller.com

**Mating connector (fully pluggable)**
**SLDV 5.08/180B**

Pin headers with solder pin length optimised for wave flow soldering. The male connectors provide space for labelling and can be coded. HC = High Current.

**General ordering data**

Type	SLD 5.08V/04/180B 3.2SN ...	Version	Product data	Packaging
Order No.	<a href="#">1726740000</a>	PCB plug-in connector, male header, Dovetails for fixing blocks, THT	IEC: 400 V / 14 A	Box
GTIN (EAN)	4032248062621	solder connection, 5.08 mm, Number of poles: 4, 180°, Solder pin	UL: 300 V / 10 A	
Qty.	50 pc(s).	length (l): 3.2 mm, tinned, orange, Box		

**SL 5.08/135B**

Male connectors with 135° outlet direction. The solder pin length is optimised for wave flow soldering. The pin headers provide space for labelling and can be coded.

**General ordering data**

Type	SL 5.08/02/135B 3.2SN O ...	Version	Product data	Packaging
Order No.	<a href="#">1605530000</a>	PCB plug-in connector, male header, Dovetails for fixing blocks, THT	IEC: 400 V / 17 A	Box
GTIN (EAN)	4008190104290	solder connection, 5.08 mm, Number of poles: 2, 135°, Solder pin	UL: 300 V / 15 A	
Qty.	100 pc(s).	length (l): 3.2 mm, tinned, orange, Box		

**OMNIMATE Signal - series BL/SL 5.08  
BLZP 5.08HC/02/225 SN OR BX**

**Weidmüller Interface GmbH & Co. KG**  
Klingenbergstraße 26  
D-32758 Detmold  
Germany  
Fon: +49 5231 14-0  
Fax: +49 5231 14-292083  
www.weidmueller.com

**Mating connector (fully pluggable)**
**SL 5.08/180**

Male connectors with straight outlet direction. The solder pin length is optimised for wave flow soldering. The pin headers provide space for labelling and can be coded.

**General ordering data**

Type	SL 5.08/02/180 3.2SN OR ...	Version	Product data	Packaging
Order No.	<a href="#">1517260000</a>	PCB plug-in connector, male header, open side, THT solder	IEC: 400 V / 18 A	Box
GTIN (EAN)	4008190034795	connection, 5.08 mm, Number of poles: 2, 180°, Solder pin length (l):	UL: 300 V / 15 A	
Qty.	100 pc(s).	3.2 mm, tinned, orange, Box		

**SLS 5.08/180 SN**

Male plugs with clamping-yoke screw wire-connect system. The male plugs provide space for labelling and can be coded.

**General ordering data**

Type	SLS 5.08/02/180 SN OR BX	Version	Product data	Packaging
Order No.	<a href="#">1627090000</a>	PCB plug-in connector, male plug, 5.08 mm, Number of poles: 2,	IEC: 400 V / 21.5 A / 0.2 - 2.5 mm <sup>2</sup>	Box
GTIN (EAN)	4008190199609	180°, Clamping yoke connection, Clamping range, max. : 3.31 mm <sup>2</sup> ,	UL: 300 V / 14 A / AWG 26 - AWG 12	
Qty.	180 pc(s).	Box		

**OMNIMATE Signal - series BL/SL 5.08  
BLZP 5.08HC/02/225 SN OR BX**

**Weidmüller Interface GmbH & Co. KG**  
Klingenbergstraße 26  
D-32758 Detmold  
Germany  
Fon: +49 5231 14-0  
Fax: +49 5231 14-292083  
www.weidmueller.com

**Mating connector (fully pluggable)**
**SL 5.08HC/90**

Pin headers made from glass-fibre-reinforced plastic with 90° wire outlet; optimised for wave soldering. The flange variant (F) can be screwed onto the respective counter piece or the circuit board. There is no need for an extra screw to connect the circuit board when the solder flange (LF) version is used. This also protects the solder points from mechanical strain. All pin headers can be manually coded or ordered pre-coded. HC = High Current.

**General ordering data**

Type	SL 5.08HC/02/90 3.2SN B ...	Version	Product data	Packaging
Order No.	<a href="#">1155030000</a>	PCB plug-in connector, male header, open side, THT solder connection, 5.08 mm, Number of poles: 2, 90°, Solder pin length (l): 3.2 mm, tinned, black, Box	IEC: 400 V / 24 A UL: 300 V / 18.5 A	Box
GTIN (EAN)	4050118050813			
Qty.	100 pc(s).			
Type	SL 5.08HC/02/90 3.2SN O ...	Version	Product data	Packaging
Order No.	<a href="#">1146720000</a>	PCB plug-in connector, male header, open side, THT solder connection, 5.08 mm, Number of poles: 2, 90°, Solder pin length (l): 3.2 mm, tinned, orange, Box	IEC: 400 V / 24 A UL: 300 V / 18.5 A	Box
GTIN (EAN)	4050118051506			
Qty.	100 pc(s).			

**SL-SMT 5.08/270GH Box**

High-temperature-resistant, straight, open pin header. Packed in box or tape. On tape and with 1.5 mm solder pin, optimised for automatic assembly. 3.2 mm solder pin suitable for reflow and wave soldering. The pin headers provide space for labelling and can be coded. HC = High Current.

**General ordering data**

Type	SL-SMT 5.08HC/02/270GH ...	Version	Product data	Packaging
Order No.	<a href="#">1876340000</a>	PCB plug-in connector, male header, closed side, THT/THR solder connection, 5.08 mm, Number of poles: 2, 270°, Solder pin length (l): 1.5 mm, tinned, black, Box	IEC: 400 V / 27.5 A UL: 300 V / 18.5 A	Box
GTIN (EAN)	4032248466818			
Qty.	100 pc(s).			
Type	SL-SMT 5.08HC/02/270GH ...	Version	Product data	Packaging
Order No.	<a href="#">1877370000</a>	PCB plug-in connector, male header, closed side, THT/THR solder connection, 5.08 mm, Number of poles: 2, 270°, Solder pin length (l): 3.2 mm, tinned, black, Box	IEC: 400 V / 27.5 A UL: 300 V / 18.5 A	Box
GTIN (EAN)	4032248468003			
Qty.	100 pc(s).			

**OMNIMATE Signal - series BL/SL 5.08  
BLZP 5.08HC/02/225 SN OR BX**

**Weidmüller Interface GmbH & Co. KG**  
 Klingenbergstraße 26  
 D-32758 Detmold  
 Germany  
 Fon: +49 5231 14-0  
 Fax: +49 5231 14-292083  
 www.weidmueller.com

**Mating connector (fully pluggable)**
**SL-SMT 5.08/270GL Box**

High-temperature-resistant, straight, open pin header. Packed in box or tape. On tape and with 1.5 mm solder pin, optimised for automatic assembly. 3.2 mm solder pin suitable for reflow and wave soldering. The pin headers provide space for labelling and can be coded. HC = High Current.

**General ordering data**

Type	SL-SMT 5.08HC/02/270GL ...	Version	Product data	Packaging
Order No.	<a href="#">1877100000</a>	PCB plug-in connector, male header, closed side, THT/THR solder connection, 5.08 mm, Number of poles: 2, 270°, Solder pin length (l): 1.5 mm, tinned, black, Box	IEC: 400 V / 27.5 A UL: 300 V / 18.5 A	Box
GTIN (EAN)	4032248467570			
Qty.	100 pc(s).			
Type	SL-SMT 5.08HC/02/270GL ...	Version	Product data	Packaging
Order No.	<a href="#">1877470000</a>	PCB plug-in connector, male header, closed side, THT/THR solder connection, 5.08 mm, Number of poles: 2, 270°, Solder pin length (l): 3.2 mm, tinned, black, Box	IEC: 400 V / 27.5 A UL: 300 V / 18.5 A	Box
GTIN (EAN)	4032248468096			
Qty.	100 pc(s).			

## OMNIMATE Signal - series BL/SL 5.08 BLZP 5.08HC/02/225 SN OR BX

**Weidmüller Interface GmbH & Co. KG**  
 Klingenbergstraße 26  
 D-32758 Detmold  
 Germany  
 Fon: +49 5231 14-0  
 Fax: +49 5231 14-292083  
 www.weidmueller.com

# Accessories

### Crosshead screwdriver Phillips

Crosshead screwdriver, Phillips, SDK PH DIN 5262, ISO 8764/2-PH, output to ISO 8764-PH, ChromTop tip, SoftFinish grip



### General ordering data

Type	SDK PH1	Version
Order No.	<a href="#">9008480000</a>	Screwdriver, Blade width (B): 4.5 mm, Blade length: 80 mm
GTIN (EAN)	4032248056477	
Qty.	1 pc(s).	

### Coding elements



**Only connects what is supposed to be connected: the right connection at the right place.**

Coding elements and locking devices clearly assign connecting elements during the manufacturing process and operation

The coding elements and locking devices are inserted prior to assembly or during the cable assembly phase.

The Weidmüller alternative: configure online using the variant configurator to precode prior to delivery.

Incorrect assembly on the circuit board and incorrect plugging of connecting elements is no longer possible.

The advantage: no troubleshooting during manufacture and no operational errors by the user.

### General ordering data

Type	BLZ/SL KO BK BX	Version	Product data	Packaging
Order No.	<a href="#">1545710000</a>	PCB plug-in connector, Accessories, Coding element, black, Number		Box
GTIN (EAN)	4008190087142	of poles: 1		
Qty.	50 pc(s).			
Type	BLZ/SL KO OR BX	Version	Product data	Packaging
Order No.	<a href="#">1573010000</a>	PCB plug-in connector, Accessories, Coding element, orange, Number		Box
GTIN (EAN)	4008190048396	of poles: 1		
Qty.	100 pc(s).			



**Data sheet**

**OMNIMATE Signal - series BL/SL 5.08  
BLZP 5.08HC/02/225 SN OR BX**

**Weidmüller Interface GmbH & Co. KG**  
Klingenbergstraße 26  
D-32758 Detmold  
Germany  
Fon: +49 5231 14-0  
Fax: +49 5231 14-292083  
www.weidmueller.com

**Accessories**

**Crosshead screwdriver Pozidriv**

Crosshead screwdriver, Pozidriv, SDK PZ DIN 5262, ISO 8764/2-PZ, output to ISO 8764/1-PZ, ChromTop tip, SoftFinish grip



**General ordering data**

Type	SDK PZ1	Version
Order No.	<a href="#">9008530000</a>	Screwdriver, Blade width (B): 4.5 mm, Blade length: 80 mm
GTIN (EAN)	4032248056521	
Qty.	1 pc(s).	

**Slotted screwdriver**

Slotted screwdriver with rounded blade SD DIN 5265, ISO 2380/2, output to DIN 5264, ISO 2380/1. ChromTop tip, SoftFinish grip



**General ordering data**

Type	SDS 0.6X3.5X100	Version
Order No.	<a href="#">9008330000</a>	Screwdriver, Blade width (B): 3.5 mm, Blade length: 100 mm, Blade thickness (A): 0.6 mm
GTIN (EAN)	4032248056286	
Qty.	1 pc(s).	

**Data sheet****OMNIMATE Signal - series BL/SL 5.08  
BLZP 5.08HC/02/225 SN OR BX**

**Weidmüller Interface GmbH & Co. KG**  
Klingenbergstraße 26  
D-32758 Detmold  
Germany  
Fon: +49 5231 14-0  
Fax: +49 5231 14-292083  
www.weidmueller.com

**Accessories****Slotted screwdriver**

VDE insulated slot-head screwdriver, SDI DIN 7437, ISO 2380/2, drive output acc. to DIN 5264, ISO 2380/1. SoftFinish grip

**General ordering data**

Type	SDIS 0.6X3.5X100	Version
Order No.	<a href="#">9008390000</a>	Screwdriver, Blade width (B): 3.5 mm, Blade length: 100 mm, Blade
GTIN (EAN)	4032248056354	thickness (A): 0.6 mm
Qty.	1 pc(s).	

MASSE OHNE TOLERANZ SIND KEINE PRUEFMASSE  
 DIMS. WITHOUT TOLERANCE ARE NOT CONTROL DIMS.

DIE DEUTSCHE VERSION IST VERBINDLICH  
 THE GERMAN VERSION IS BINDING

WEITERGABE SOWIE VERVIELFAELTIGUNG DIESES DOKUMENTS, VERWERTUNG UND MITTEILUNG SEINES INHALTS SIND VERBOTEN, SOWEIT NICHT AUSDRUECKLICH GESTATTET.  
 ZUWIDERHANDLUNGEN VERPFLICHTEN ZU SCHADENERSATZ. ALLE RECHTE FUER DEN FALL DER PATENT-, GEBRAUCHSMUSTER- ODER GESCHMACKSMUSTEREINTRAGUNG VORBEHALTEN.  
 THE REPRODUCTION, DISTRIBUTION AND UTILIZATION OF THIS DOCUMENT AS WELL AS THE COMMUNICATION OF ITS CONTENTS TO OTHERS WITHOUT EXPLICIT AUTHORIZATION IS PROHIBITED.  
 OFFENDERS WILL BE HELD LIABLE FOR THE PAYMENT OF DAMAGES. WEIDMUELLER EXCLUSIVELY RESERVES THE RIGHT TO FILE FOR PATENTS, UTILITY MODELS OR DESIGNS.  
 © WEIDMUELLER INTERFACE GmbH & Co.KG

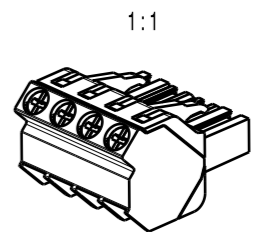
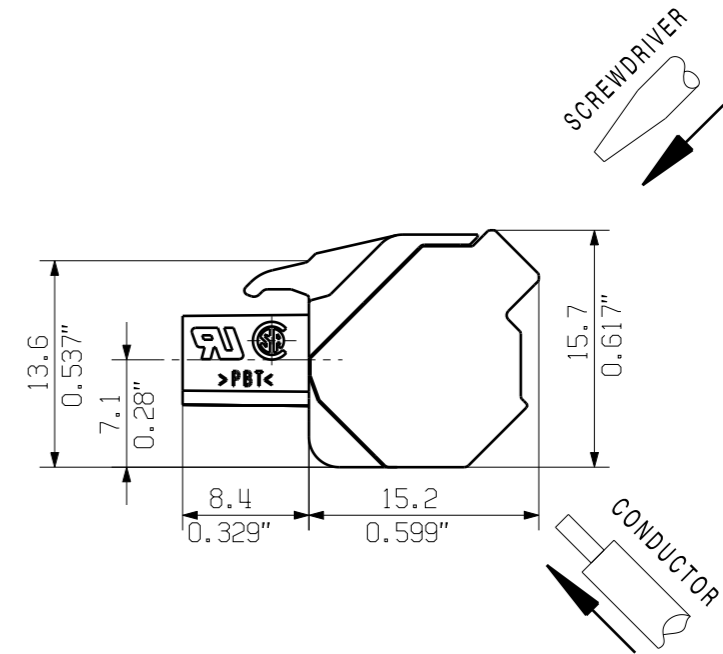
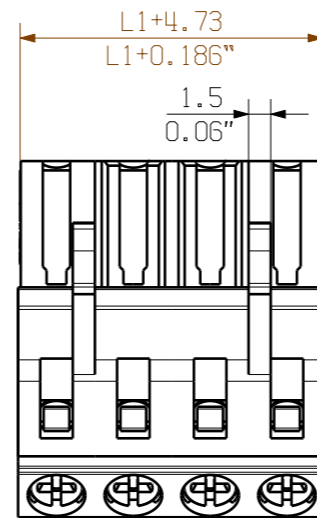
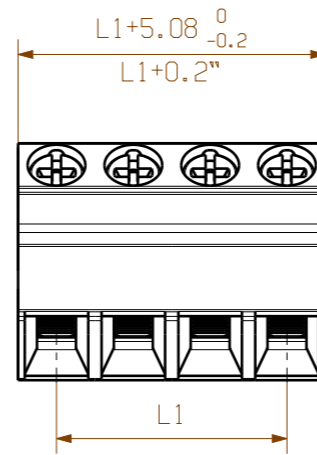

24	116,84	4,600
23	111,76	4,400
22	106,68	4,200
21	101,60	4,000
20	96,52	3,800
19	91,44	3,600
18	86,36	3,400
17	81,28	3,200
16	76,20	3,000
15	71,12	2,800
14	66,04	2,600
13	60,96	2,400
12	55,88	2,200
11	50,80	2,000
10	45,72	1,800
9	40,64	1,600
8	35,56	1,400
7	30,48	1,200
6	25,40	1,000
5	20,32	0,800
4	15,24	0,600
3	10,16	0,400
2	5,08	0,200
n	L1 [mm]	L1 [Inch]

SHOWN: BLZP 5.08HC/04/225

For the mounting of PCBs, it should be noted that the rated data given in the catalogue relates only to the connection elements. The necessary creepage and clearance paths must be observed in connection with the respective applicant in accordance to VDE 0110. The current-carrying capacity and pitch tolerance is to be determined according to DIN IEC 326 part 3 very fine.

Weidmüller connectors are tested to the DIN VDE 0627 standard, and are valid for its field of application. Provided that the connectors are used to the intended purpose, all requirements with respect to the occurring of electrical, mechanical, thermic and corrosive stress will be satisfied.

<b>GENERAL TOLERANCE:</b> DIN ISO 2768-mK		85592/0 04.12.15 HELIS_MA 01		CAT.NO.:	
		<b>MODIFICATION</b>			
		DATE 24.06.2013	NAME HERTEL_S	<b>C 39789 05</b> DRAWING NO. ISSUE NO.	
SCALE: 2:1		RESPONSIBLE HERTEL_S	<b>BLZP 5.08HC/.../225</b> BUCHSENLEISTE SOCKET BLOCK		
SUPERSEDES:		CHECKED 18.12.2015 LANG_T	APPROVED	PRODUCT FILE: BLZP 5.0X 7157	
				SHEET 01 OF 03 SHEETS	