

OMNIMATE Signal - series BL/SL 5.08 BLZP 5.08HC/10/180 SN BK BX

Weidmüller Interface GmbH & Co. KG
Klingenbergstraße 26
D-32758 Detmold
Germany
Fon: +49 5231 14-0
Fax: +49 5231 14-292083
www.weidmueller.com

Product image

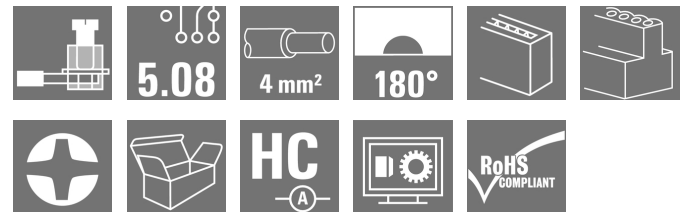

Similar to illustration

Female plug with clamping-yoke screw system for connecting wires with straight (180°) outlet direction. The female connectors provide space for labelling and can be coded. Fastened by means of a flange or release latch. They also provide an integrated plus/minus screw, protection against faulty insertion of the wire, and they are delivered with open clamping yokes. HC = High Current.

General ordering data

Type	BLZP 5.08HC/10/180 SN BK BX
Order No.	1943890000
Version	PCB plug-in connector, female plug, 5.08 mm, Number of poles: 10, 180°, Clamping yoke connection, Clamping range, max. : 4 mm², Box
GTIN (EAN)	4032248618002
Qty.	36 pc(s).
Product data	IEC: 400 V / 23 A / 0.2 - 4 mm² UL: 300 V / 20 A / AWG 26 - AWG 12
Packaging	Box

Creation date May 3, 2020 10:34:40 AM CEST

**OMNIMATE Signal - series BL/SL 5.08
BLZP 5.08HC/10/180 SN BK BX**

Weidmüller Interface GmbH & Co. KG
Klingenbergstraße 26
D-32758 Detmold
Germany
Fon: +49 5231 14-0
Fax: +49 5231 14-292083
www.weidmueller.com

Technical data**Dimensions and weights**

Width	50.8 mm	Width (inches)	2 inch
Height	16 mm	Height (inches)	0.63 inch
Depth	20.1 mm	Depth (inches)	0.791 inch
Net weight	16.844 g		

System Parameters

Product family	OMNIMATE Signal - series BL/SL 5.08	Type of connection	Field connection
Wire connection method	Clamping yoke connection	Pitch in mm (P)	5.08 mm
Pitch in inches (P)	0.2 inch	Conductor outlet direction	180°
Number of poles	10	L1 in mm	45.72 mm
L1 in inches	1.8 inch	Number of rows	1
Pin series quantity	1	Rated cross-section	4 mm ²
Touch-safe protection acc. to DIN VDE 57 106	Safe from finger touch	Volume resistance	≤ 5mΩ
Can be coded	Yes	Stripping length	7 mm
Tightening torque, min.	0.4 Nm	Tightening torque, max.	0.5 Nm
Clamping screw	M 2.5	Screwdriver blade	0.6 x 3.5, PH 1, PZ 1
Screwdriver blade standard	DIN 5264, ISO 8764/2-PH, ISO 8764/2-PZ	Plugging cycles	25
Plugging force/pole, max.	10 N	Pulling force/pole, max.	9 N

Material data

Insulating material	PBT	Colour	black
Colour chart (similar)	RAL 9011	Insulating material group	Illa
Comparative Tracking Index (CTI)	≥ 200	Insulation strength	≥ 10 ⁸ Ω
UL 94 flammability rating	V-0	GWFI	960 °C
Contact material	Copper alloy	Contact surface	tinned
Layer structure of plug contact	4-8 μm Sn hot-dip tinned	Storage temperature, min.	-25 °C
Storage temperature, max.	50 °C	Max. relative humidity during storage	70 %
Operating temperature, min.	-50 °C	Operating temperature, max.	100 °C
Temperature range, installation, min.	-25 °C	Temperature range, installation, max.	100 °C

Conductors suitable for connection

Clamping range, min.	0.13 mm ²
Clamping range, max.	4 mm ²
Wire connection cross section AWG, min.	AWG 30
Wire connection cross section AWG, max.	AWG 12
Solid, min. H05(07) V-U	0.2 mm ²
Solid, max. H05(07) V-U	4 mm ²
Flexible, min. H05(07) V-K	0.2 mm ²
Flexible, max. H05(07) V-K	4 mm ²
w. plastic collar ferrule, DIN 46228 pt 4, 0.2 mm ² min.	
w. plastic collar ferrule, DIN 46228 pt 4, 2.5 mm ² max.	
w. wire end ferrule, DIN 46228 pt 1, min.	0.2 mm ²
w. wire end ferrule, DIN 46228 pt 1, max.	4 mm ²

Creation date May 3, 2020 10:34:40 AM CEST

OMNIMATE Signal - series BL/SL 5.08
BLZP 5.08HC/10/180 SN BK BX

Weidmüller Interface GmbH & Co. KG
 Klingenbergstraße 26
 D-32758 Detmold
 Germany
 Fon: +49 5231 14-0
 Fax: +49 5231 14-292083
 www.weidmueller.com

Technical data

Plug gauge in accordance with EN 60999 a x b; ø 2.8 mm x 2.4 mm

Clampable conductor	Cross-section for conductor connection	Type	fine-wired
		nominal	0.5 mm ²
wire end ferrule		Stripping length	nominal 6 mm
		Recommended wire-end ferrule	H0.5/6
Clampable conductor	Cross-section for conductor connection	Type	fine-wired
		nominal	1 mm ²
wire end ferrule		Stripping length	nominal 6 mm
		Recommended wire-end ferrule	H1.0/6
Clampable conductor	Cross-section for conductor connection	Type	fine-wired
		nominal	1.5 mm ²
wire end ferrule		Stripping length	nominal 7 mm
		Recommended wire-end ferrule	H1.5/7
Clampable conductor	Cross-section for conductor connection	Type	fine-wired
		nominal	2.5 mm ²
wire end ferrule		Stripping length	nominal 7 mm
		Recommended wire-end ferrule	H2.5/7

Reference text The outside diameter of the plastic collar should not be larger than the pitch (P), Length of ferrules is to be chosen depending on the product and the rated voltage.

Max. clamping range 4 mm²

Rated data acc. to IEC

tested acc. to standard	IEC 60664-1, IEC 61984	Rated current, min. number of poles (Tu=20°C)	23 A
Rated current, max. number of poles (Tu=20°C)	18 A	Rated current, min. number of poles (Tu=40°C)	21 A
Rated current, max. number of poles (Tu=40°C)	16 A	Rated voltage for surge voltage class / pollution degree II/2	400 V
Rated voltage for surge voltage class / pollution degree III/2	320 V	Rated voltage for surge voltage class / pollution degree III/3	250 V
Rated impulse voltage for surge voltage class/ pollution degree II/2	4 kV	Rated impulse voltage for surge voltage class/ pollution degree III/2	4 kV
Rated impulse voltage for surge voltage class/ contamination degree III/3	4 kV	Short-time withstand current resistance	3 x 1s with 120 A

Rated data acc. to CSA

Institute (CSA)		Certificate No. (CSA)	200039-1121690
Rated voltage (Use group B / CSA)	300 V	Rated voltage (Use group C / CSA)	50 V
Rated voltage (Use group D / CSA)	300 V	Rated current (Use group B / CSA)	20 A
Rated current (Use group D / CSA)	20 A	Wire cross-section, AWG, min.	AWG 30
Wire cross-section, AWG, max.	AWG 12	Reference to approval values	Specifications are maximum values, details - see approval certificate.



Data sheet

**OMNIMATE Signal - series BL/SL 5.08
BLZP 5.08HC/10/180 SN BK BX**

Weidmüller Interface GmbH & Co. KG
Klingenbergstraße 26
D-32758 Detmold
Germany
Fon: +49 5231 14-0
Fax: +49 5231 14-292083
www.weidmueller.com

Technical data

Rated data acc. to UL 1059

Institute (UR)		Certificate No. (UR)	E60693
Institute (cURus)		Certificate No. (cURus)	E60693
Rated voltage (Use group B / UL 1059)	300 V	Rated voltage (Use group D / UL 1059)	300 V
Rated current (Use group B / UL 1059)	20 A	Rated current (Use group D / UL 1059)	10 A
Wire cross-section, AWG, min.	AWG 26	Wire cross-section, AWG, max.	AWG 12
Reference to approval values	Specifications are maximum values, details - see approval certificate.		

Packing

Packaging	Box	VPE length	25 mm
VPE width	175 mm	VPE height	295 mm

Classifications

ETIM 6.0	EC002638	ETIM 7.0	EC002638
eClass 9.0	27-44-03-09	eClass 9.1	27-44-03-09
eClass 10.0	27-44-03-09	UNSPSC	30-21-18-01

Notes

Notes	<ul style="list-style-type: none"> • Additional colours on request • Gold-plated contact surfaces on request • Rated current related to rated cross-section & min. No. of poles. • Wire end ferrule without plastic collar to DIN 46228/1 • Wire end ferrule with plastic collar to DIN 46228/4 • P on drawing = pitch • Rated data refer only to the component itself. Clearance and creepage distances to other components are to be designed in accordance with the relevant application standards.
-------	---

IPC conformity	Conformity: The products are developed, manufactured and delivered according international recognized standards and norms and comply with the assured properties in the data sheet resp. fulfill decorative properties in accordance with IPC-A-610 "Class 2". Further claims on the products can be evaluated on request.
----------------	--

Approvals

Approvals	
ROHS	Conform

Data sheet**OMNIMATE Signal - series BL/SL 5.08
BLZP 5.08HC/10/180 SN BK BX**

Weidmüller Interface GmbH & Co. KG
Klingenbergstraße 26
D-32758 Detmold
Germany
Fon: +49 5231 14-0
Fax: +49 5231 14-292083
www.weidmueller.com

Technical data**Downloads**

Approval/Certificate/Document of Conformity	CB Certificate CB Testreport Declaration of the Manufacturer
Brochure/Catalogue	FL DRIVES EN MB DEVICE MANUF. EN FL DRIVES DE CAT 2 PORTFOLIOGUIDE EN FL BUILDING SAFETY EN FL APPL LED LIGHTING EN FLIndustr.CONTROLS EN FL MACHINE SAFETY EN FL HEATING ELECTR EN FL APPL INVERTER EN FL_BASE_STATION_EN FL ELEVATOR EN FL POWER SUPPLY EN FL 72H SAMPLE SER EN PO OMNIMATE EN
Engineering Data	EPLAN, WSCAD
Engineering Data	STEP

Data sheet

**OMNIMATE Signal - series BL/SL 5.08
BLZP 5.08HC/10/180 SN BK BX**

Weidmüller Interface GmbH & Co. KG
 Klingenbergstraße 26
 D-32758 Detmold
 Germany
 Fon: +49 5231 14-0
 Fax: +49 5231 14-292083
 www.weidmueller.com

Drawings

Dimensional drawing

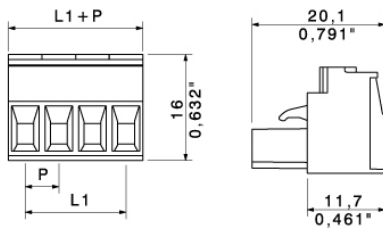

Graph

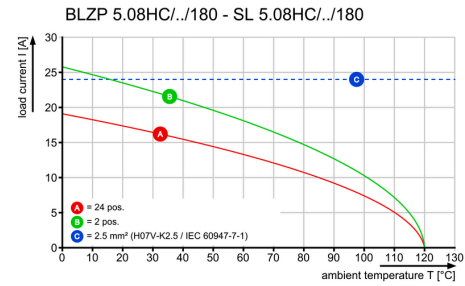

**OMNIMATE Signal - series BL/SL 5.08
BLZP 5.08HC/10/180 SN BK BX**

Weidmüller Interface GmbH & Co. KG
Klingenbergstraße 26
D-32758 Detmold
Germany
Fon: +49 5231 14-0
Fax: +49 5231 14-292083
www.weidmuller.com

Mating connector (fully pluggable)
SL 5.08HC/90B

Pin headers made from glass-fibre-reinforced plastic with 90° wire outlet; optimised for wave soldering. The flange variant (F) can be screwed onto the respective counter piece or the circuit board. There is no need for an extra screw to connect the circuit board when the solder flange (LF) version is used. This also protects the solder points from mechanical strain. All pin headers can be manually coded or ordered pre-coded. HC = High Current.

General ordering data

Type	SL 5.08HC/10/90B 3.2SN ...	Version	Product data	Packaging
Order No.	1154850000	PCB plug-in connector, male header, Dovetails for fixing blocks, THT	IEC: 400 V / 24 A	Box
GTIN (EAN)	4050118050967	solder connection, 5.08 mm, Number of poles: 10, 90°, Solder pin	UL: 300 V / 18.5 A	
Qty.	50 pc(s).	length (l): 3.2 mm, tinned, orange, Box		
Type	SL 5.08HC/10/90B 3.2SN ...	Version	Product data	Packaging
Order No.	1155670000	PCB plug-in connector, male header, Dovetails for fixing blocks, THT	IEC: 400 V / 24 A	Box
GTIN (EAN)	4050118050271	solder connection, 5.08 mm, Number of poles: 10, 90°, Solder pin	UL: 300 V / 18.5 A	
Qty.	50 pc(s).	length (l): 3.2 mm, tinned, black, Box		

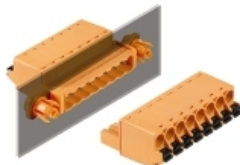
SLF 5.08/180DF SN

Male plug with PUSH IN wire connection and straight outlet direction, when used with BLF 5.08HC as wire-to-wire application for panel feed-through The male plugs provide space for labelling and can be coded.

General ordering data

Type	SLF 5.08/10/180DF SN OR ...	Version	Product data	Packaging
Order No.	1353680000	PCB plug-in connector, male plug, 5.08 mm, Number of poles: 10,	IEC: 400 V / 25.9 A / 0.2 - 2.5 mm ²	Box
GTIN (EAN)	4050118156423	180°, PUSH IN, Spring connection, Clamping range, max.: 3.31 mm ² , UL: 300 V / 14 A / AWG 26 - AWG 12		
Qty.	24 pc(s).	Box		

**OMNIMATE Signal - series BL/SL 5.08
BLZP 5.08HC/10/180 SN BK BX**

Weidmüller Interface GmbH & Co. KG
Klingenbergstraße 26
D-32758 Detmold
Germany
Fon: +49 5231 14-0
Fax: +49 5231 14-292083
www.weidmueller.com

Mating connector (fully pluggable)
SLT 5.08B

Male plugs with screw TOP wire connection. The male plug provides space for labelling and can be coded.

General ordering data

Type	SLT 5.08/10/180B SN OR ...	Version	Product data	Packaging
Order No.	1611790000	PCB plug-in connector, male plug, 5.08 mm, Number of poles: 10,	IEC: 400 V / 16 A / 0.2 - 2.5 mm ²	Box
GTIN (EAN)	4008190192679	180°, TOP connection, Clamping range, max. : 2.5 mm ² , Box	UL: 300 V / 15 A / AWG 26 - AWG 14	
Qty.	50 pc(s).			

SLDV 5.08/90B

Pin headers with solder pin length optimised for wave flow soldering. The male connectors provide space for labelling and can be coded. HC = High Current.

General ordering data

Type	SLD 5.08V/20/90B 3.2 SN ...	Version	Product data	Packaging
Order No.	1726360000	PCB plug-in connector, male header, Dovetails for fixing blocks, THT	IEC: 400 V / 17 A	Box
GTIN (EAN)	4032248061334	solder connection, 5.08 mm, Number of poles: 20, 90°, Solder pin	UL: 300 V / 10 A	
Qty.	20 pc(s).	length (l): 3.2 mm, tinned, orange, Box		

**OMNIMATE Signal - series BL/SL 5.08
BLZP 5.08HC/10/180 SN BK BX**

Weidmüller Interface GmbH & Co. KG
Klingenbergstraße 26
D-32758 Detmold
Germany
Fon: +49 5231 14-0
Fax: +49 5231 14-292083
www.weidmueller.com

Mating connector (fully pluggable)
SL 5.08/90B

Male connectors with 90° outlet direction. The solder pin length is optimised for wave flow soldering. The pin headers provide space for labelling and can be coded.

General ordering data

Type	SL 5.08/10/90B 3.2SN OR ...	Version	Product data	Packaging
Order No.	1511160000	PCB plug-in connector, male header, Dovetails for fixing blocks, THT	IEC: 400 V / 18 A	Box
GTIN (EAN)	4008190052485	solder connection, 5.08 mm, Number of poles: 10, 90°, Solder pin	UL: 300 V / 15 A	
Qty.	50 pc(s).	length (l): 3.2 mm, tinned, orange, Box		

SL 5.08/135

Male connectors with 135° outlet direction. The solder pin length is optimised for wave flow soldering. The pin headers provide space for labelling and can be coded.

General ordering data

Type	SL 5.08/10/135 3.2SN OR ...	Version	Product data	Packaging
Order No.	1603140000	PCB plug-in connector, male header, open side, THT solder	IEC: 400 V / 17 A	Box
GTIN (EAN)	4008190082123	connection, 5.08 mm, Number of poles: 10, 135°, Solder pin length	UL: 300 V / 15 A	
Qty.	50 pc(s).	(l): 3.2 mm, tinned, orange, Box		

**OMNIMATE Signal - series BL/SL 5.08
BLZP 5.08HC/10/180 SN BK BX**

Weidmüller Interface GmbH & Co. KG
Klingenbergstraße 26
D-32758 Detmold
Germany
Fon: +49 5231 14-0
Fax: +49 5231 14-292083
www.weidmueller.com

Mating connector (fully pluggable)
SLDV 5.08/90

Pin headers with solder pin length optimised for wave flow soldering. The male connectors provide space for labelling and can be coded. HC = High Current.

General ordering data

Type	SLD 5.08V/20/90 3.2 SN ...	Version	Product data	Packaging
Order No.	1725250000	PCB plug-in connector, male header, open side, THT solder connection, 5.08 mm, Number of poles: 20, 90°, Solder pin length (l): 3.2 mm, tinned, orange, Box	IEC: 400 V / 17 A UL: 300 V / 10 A	Box
GTIN (EAN)	4032248060658			
Qty.	20 pc(s).			

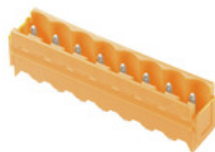
SL 5.08HC/180B

Pin headers in glass-fibre-reinforced plastic with straight wire outlet; optimised for wave soldering. The flange variant (F) can be screwed onto the respective counter piece or the circuit board. There is no need for an extra screw to connect the circuit board when the solder flange (LF) version is used. This also protects the solder points from mechanical strain. All pin headers can be manually coded or ordered pre-coded. HC = High Current.

General ordering data

Type	SL 5.08HC/10/180B 3.2SN ...	Version	Product data	Packaging
Order No.	1149670000	PCB plug-in connector, male header, Dovetails for fixing blocks, THT solder connection, 5.08 mm, Number of poles: 10, 180°, Solder pin length (l): 3.2 mm, tinned, black, Box	IEC: 400 V / 24 A UL: 300 V / 18.5 A	Box
GTIN (EAN)	4032248934904			
Qty.	50 pc(s).			
Type	SL 5.08HC/10/180B 3.2SN ...	Version	Product data	Packaging
Order No.	1147580000	PCB plug-in connector, male header, Dovetails for fixing blocks, THT solder connection, 5.08 mm, Number of poles: 10, 180°, Solder pin length (l): 3.2 mm, tinned, orange, Box	IEC: 400 V / 24 A UL: 300 V / 18.5 A	Box
GTIN (EAN)	4032248934249			
Qty.	50 pc(s).			

**OMNIMATE Signal - series BL/SL 5.08
BLZP 5.08HC/10/180 SN BK BX**

Weidmüller Interface GmbH & Co. KG
Klingenbergstraße 26
D-32758 Detmold
Germany
Fon: +49 5231 14-0
Fax: +49 5231 14-292083
www.weidmueller.com

Mating connector (fully pluggable)
SL-SMT 5.08/180G Box

High-temperature-resistant pin header, packed in box or tape. On tape, with 1.5 mm solder pin, optimised for automatic assembly. 3.2 mm solder pin suitable for reflow and wave soldering. The pin headers provide space for labelling and can be coded. HC = High Current.

General ordering data

Type	SL-SMT 5.08HC/10/180G 1 ...	Version	Product data	Packaging
Order No.	1776002001	PCB plug-in connector, male header, closed side, THT/THR solder connection, 5.08 mm, Number of poles: 10, 180°, Solder pin length (l): 1.5 mm, tinned, black, Box	IEC: 400 V / 27.5 A UL: 300 V / 18.5 A	Box
GTIN (EAN)	4032248158997			
Qty.	50 pc(s).			
Type	SL-SMT 5.08HC/10/180G 3 ...	Version	Product data	Packaging
Order No.	1838290000	PCB plug-in connector, male header, closed side, THT/THR solder connection, 5.08 mm, Number of poles: 10, 180°, Solder pin length (l): 3.2 mm, tinned, black, Box	IEC: 400 V / 27.5 A UL: 300 V / 18.5 A	Box
GTIN (EAN)	4032248348350			
Qty.	50 pc(s).			

SL-SMT 5.08/180 Box

High-temperature-resistant, straight, open pin header. Packed in box or tape. On tape and with 1.5 mm solder pin, optimised for automatic assembly. 3.2 mm solder pin suitable for reflow and wave soldering. The pin headers provide space for labelling and can be coded. HC = High Current.

General ordering data

Type	SL-SMT 5.08HC/10/180 3. ...	Version	Product data	Packaging
Order No.	1838060000	PCB plug-in connector, male header, open side, THT/THR solder connection, 5.08 mm, Number of poles: 10, 180°, Solder pin length (l): 3.2 mm, tinned, black, Box	IEC: 400 V / 27.5 A UL: 300 V / 18.5 A	Box
GTIN (EAN)	4032248348121			
Qty.	50 pc(s).			
Type	SL-SMT 5.08HC/10/180 1. ...	Version	Product data	Packaging
Order No.	1775682001	PCB plug-in connector, male header, open side, THT/THR solder connection, 5.08 mm, Number of poles: 10, 180°, Solder pin length (l): 1.5 mm, tinned, black, Box	IEC: 400 V / 27.5 A UL: 300 V / 18.5 A	Box
GTIN (EAN)	4032248158324			
Qty.	50 pc(s).			

**OMNIMATE Signal - series BL/SL 5.08
BLZP 5.08HC/10/180 SN BK BX**

Weidmüller Interface GmbH & Co. KG
 Klingenbergstraße 26
 D-32758 Detmold
 Germany
 Fon: +49 5231 14-0
 Fax: +49 5231 14-292083
 www.weidmueller.com

Mating connector (fully pluggable)
SLDV 5.08/180

Pin headers with solder pin length optimised for wave flow soldering. The male connectors provide space for labelling and can be coded. HC = High Current.

General ordering data

Type	SLD 5.08V/20/180 3.2SN ...	Version	Product data	Packaging
Order No.	1725730000	PCB plug-in connector, male header, open side, THT solder connection, 5.08 mm, Number of poles: 20, 180°, Solder pin length (l): 3.2 mm, tinned, orange, Box	IEC: 400 V / 14 A UL: 300 V / 10 A	Box
GTIN (EAN)	4032248062027			
Qty.	20 pc(s).			

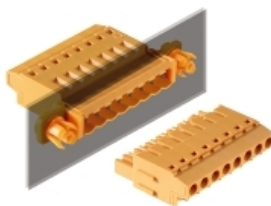
SLT 5.08/180DF SN

Male plugs with screw TOP wire connection. The male plug provides space for labelling and can be coded.

General ordering data

Type	SLT 5.08/10/180DF SN OR ...	Version	Product data	Packaging
Order No.	1353450000	PCB plug-in connector, male plug, 5.08 mm, Number of poles: 10, 180°, TOP connection, Clamping range, max. : 2.5 mm², Box	IEC: 400 V / 16 A / 0.2 - 2.5 mm² UL: 300 V / 15 A / AWG 26 - AWG 14	Box
GTIN (EAN)	4050118156102			
Qty.	24 pc(s).			

**OMNIMATE Signal - series BL/SL 5.08
BLZP 5.08HC/10/180 SN BK BX**

Weidmüller Interface GmbH & Co. KG
Klingenbergstraße 26
D-32758 Detmold
Germany
Fon: +49 5231 14-0
Fax: +49 5231 14-292083
www.weidmueller.com

Mating connector (fully pluggable)
SL-SMT 5.08HC/90 Box

High-temperature-resistant, 90° angled, open male header. Packed in box or tape. On tape, with 1.5 mm solder pin, optimised for automatic assembly. 3.2 mm solder pin suitable for reflow and wave soldering. The pin headers provide space for labelling and can be coded. HC = High Current.

General ordering data

Type	SL-SMT 5.08HC/10/90 3.2 ...	Version	Product data	Packaging
Order No.	1780030000	PCB plug-in connector, male header, open side, THT/THR solder connection, 5.08 mm, Number of poles: 10, 90°, Solder pin length (l): 3.2 mm, tinned, black, Box	IEC: 400 V / 27.5 A UL: 300 V / 18.5 A	Box
GTIN (EAN)	4032248165353			
Qty.	50 pc(s).			
Type	SL-SMT 5.08HC/10/90 1.5 ...	Version	Product data	Packaging
Order No.	1774842001	PCB plug-in connector, male header, open side, THT/THR solder connection, 5.08 mm, Number of poles: 10, 90°, Solder pin length (l): 1.5 mm, tinned, black, Box	IEC: 400 V / 27.5 A UL: 300 V / 18.5 A	Box
GTIN (EAN)	4032248155880			
Qty.	50 pc(s).			

SL 5.08/180B

Male connectors with straight outlet direction. The solder pin length is optimised for wave flow soldering. The pin headers provide space for labelling and can be coded.

General ordering data

Type	SL 5.08/10/180B 3.2SN O ...	Version	Product data	Packaging
Order No.	1520360000	PCB plug-in connector, male header, Dovetails for fixing blocks, THT solder connection, 5.08 mm, Number of poles: 10, 180°, Solder pin length (l): 3.2 mm, tinned, orange, Box	IEC: 400 V / 18 A UL: 300 V / 15 A	Box
GTIN (EAN)	4008190030612			
Qty.	50 pc(s).			

**OMNIMATE Signal - series BL/SL 5.08
BLZP 5.08HC/10/180 SN BK BX**

Weidmüller Interface GmbH & Co. KG
Klingenbergstraße 26
D-32758 Detmold
Germany
Fon: +49 5231 14-0
Fax: +49 5231 14-292083
www.weidmueller.com

Mating connector (fully pluggable)
SLS 5.08TB KF35

Male plugs with clamping-yoke screw wire-connect system. With clip-on feet for attaching the male plugs on rail. The male plugs provide space for labelling and can be coded.

General ordering data

Type	SLS 5.08/10/180TB KF SN ...	Version	Product data	Packaging
Order No.	1846160000	PCB plug-in connector, male plug, 5.08 mm, Number of poles: 10,	IEC: 400 V / 21.5 A / 0.2 - 2.5 mm ²	Box
GTIN (EAN)	4032248362448	180°, Clamping yoke connection, Clamping range, max. : 3.31 mm ² ,	UL: 300 V / 14 A / AWG 26 - AWG 12	
Qty.	10 pc(s).	Box		

SLF 5.08/180 SN

Male plug with PUSH IN wire connection and straight outlet direction, when used with BLF 5.08HC as wire-to-wire application for panel feed-through The male plugs provide space for labelling and can be coded.

General ordering data

Type	SLF 5.08/10/180 SN BK BX	Version	Product data	Packaging
Order No.	1335710000	PCB plug-in connector, male plug, 5.08 mm, Number of poles: 10,	IEC: 400 V / 25.9 A / 0.2 - 2.5 mm ²	Box
GTIN (EAN)	4050118139143	180°, PUSH IN, Spring connection, Clamping range, max. : 3.31 mm ² ,	UL: 300 V / 14 A / AWG 26 - AWG 12	
Qty.	36 pc(s).	Box		
Type	SLF 5.08/10/180 SN OR BX	Version	Product data	Packaging
Order No.	1335410000	PCB plug-in connector, male plug, 5.08 mm, Number of poles: 10,	IEC: 400 V / 25.9 A / 0.2 - 2.5 mm ²	Box
GTIN (EAN)	4050118138719	180°, PUSH IN, Spring connection, Clamping range, max. : 3.31 mm ² ,	UL: 300 V / 14 A / AWG 26 - AWG 12	
Qty.	36 pc(s).	Box		

**OMNIMATE Signal - series BL/SL 5.08
BLZP 5.08HC/10/180 SN BK BX**

Weidmüller Interface GmbH & Co. KG
Klingenbergstraße 26
D-32758 Detmold
Germany
Fon: +49 5231 14-0
Fax: +49 5231 14-292083
www.weidmueller.com

Mating connector (fully pluggable)
SL-SMT 5.08HC/90G Box

High-temperature-resistant pin header, packed in box or tape. On tape, with 1.5 mm solder pin, optimised for automatic assembly. 3.2 mm solder pin suitable for reflow and wave soldering. The pin headers provide space for labelling and can be coded. HC = High Current.

General ordering data

Type	SL-SMT 5.08HC/10/90G 1. ...	Version	Product data	Packaging
Order No.	1775083001	PCB plug-in connector, male header, closed side, THT/THR solder connection, 5.08 mm, Number of poles: 10, 90°, Solder pin length (l): 1.5 mm, tinned, black, Tray	IEC: 400 V / 27.5 A UL: 300 V / 18.5 A	Tray
GTIN (EAN)	4032248166312			
Qty.	30 pc(s).			
Type	SL-SMT 5.08HC/10/90G 3. ...	Version	Product data	Packaging
Order No.	1780260000	PCB plug-in connector, male header, closed side, THT/THR solder connection, 5.08 mm, Number of poles: 10, 90°, Solder pin length (l): 3.2 mm, tinned, black, Box	IEC: 400 V / 27.5 A UL: 300 V / 18.5 A	Box
GTIN (EAN)	4032248165582			
Qty.	50 pc(s).			
Type	SL-SMT 5.08HC/10/90G 1. ...	Version	Product data	Packaging
Order No.	1775082001	PCB plug-in connector, male header, closed side, THT/THR solder connection, 5.08 mm, Number of poles: 10, 90°, Solder pin length (l): 1.5 mm, tinned, black, Box	IEC: 400 V / 27.5 A UL: 300 V / 18.5 A	Box
GTIN (EAN)	4032248156559			
Qty.	50 pc(s).			

SL 5.08HC/180G

Pin headers in glass-fibre-reinforced plastic with straight wire outlet; optimised for wave soldering. The flange variant (F) can be screwed onto the respective counter piece or the circuit board. There is no need for an extra screw to connect the circuit board when the solder flange (LF) version is used. This also protects the solder points from mechanical strain. All pin headers can be manually coded or ordered pre-coded. HC = High Current.

General ordering data

Type	SL 5.08HC/10/180G 3.2SN ...	Version	Product data	Packaging
Order No.	1146910000	PCB plug-in connector, male header, closed side, THT solder connection, 5.08 mm, Number of poles: 10, 180°, Solder pin length (l): 3.2 mm, tinned, orange, Box	IEC: 400 V / 24 A UL: 300 V / 18.5 A	Box
GTIN (EAN)	4032248108602			
Qty.	50 pc(s).			
Type	SL 5.08HC/10/180G 3.2SN ...	Version	Product data	Packaging
Order No.	1148900000	PCB plug-in connector, male header, closed side, THT solder connection, 5.08 mm, Number of poles: 10, 180°, Solder pin length (l): 3.2 mm, tinned, black, Box	IEC: 400 V / 24 A UL: 300 V / 18.5 A	Box
GTIN (EAN)	4032248935369			
Qty.	50 pc(s).			

**OMNIMATE Signal - series BL/SL 5.08
BLZP 5.08HC/10/180 SN BK BX**

Weidmüller Interface GmbH & Co. KG
Klingenbergstraße 26
D-32758 Detmold
Germany
Fon: +49 5231 14-0
Fax: +49 5231 14-292083
www.weidmueller.com

Mating connector (fully pluggable)
SLF 5.08/180B SN

Male plug with PUSH IN wire connection and straight outlet direction, when used with BLF 5.08HC as wire-to-wire application for panel feed-through The male plugs provide space for labelling and can be coded.

General ordering data

Type	SLF 5.08/10/180B SN OR ...	Version	Product data	Packaging
Order No.	1335530000	PCB plug-in connector, male plug, 5.08 mm, Number of poles: 10,	IEC: 400 V / 25.9 A / 0.2 - 2.5 mm ²	Box
GTIN (EAN)	4050118139044	180°, PUSH IN, Spring connection, Clamping range, max. : 3.31 mm ² ,	UL: 300 V / 14 A / AWG 26 - AWG 12	
Qty.	30 pc(s).	Box		
Type	SLF 5.08/10/180B SN BK ...	Version	Product data	Packaging
Order No.	1335940000	PCB plug-in connector, male plug, 5.08 mm, Number of poles: 10,	IEC: 400 V / 25.9 A / 0.2 - 2.5 mm ²	Box
GTIN (EAN)	4050118138993	180°, PUSH IN, Spring connection, Clamping range, max. : 3.31 mm ² ,	UL: 300 V / 14 A / AWG 26 - AWG 12	
Qty.	30 pc(s).	Box		

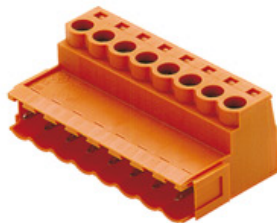
SLS 5.08/180B

Male plugs with clamping-yoke screw wire-connect system. The male plugs provide space for labelling and can be coded.

General ordering data

Type	SLS 5.08/10/180B SN OR ...	Version	Product data	Packaging
Order No.	1627320000	PCB plug-in connector, male plug, 5.08 mm, Number of poles: 10,	IEC: 400 V / 21.5 A / 0.2 - 2.5 mm ²	Box
GTIN (EAN)	4008190199838	180°, Clamping yoke connection, Clamping range, max. : 3.31 mm ² ,	UL: 300 V / 14 A / AWG 26 - AWG 12	
Qty.	30 pc(s).	Box		

**OMNIMATE Signal - series BL/SL 5.08
BLZP 5.08HC/10/180 SN BK BX**

Weidmüller Interface GmbH & Co. KG
Klingenbergstraße 26
D-32758 Detmold
Germany
Fon: +49 5231 14-0
Fax: +49 5231 14-292083
www.weidmueller.com

Mating connector (fully pluggable)
SL 5.08HC/180

Pin headers in glass-fibre-reinforced plastic with straight wire outlet; optimised for wave soldering. The flange variant (F) can be screwed onto the respective counter piece or the circuit board. There is no need for an extra screw to connect the circuit board when the solder flange (LF) version is used. This also protects the solder points from mechanical strain. All pin headers can be manually coded or ordered pre-coded. HC = High Current.

General ordering data

Type	SL 5.08HC/10/180 3.2SN ...	Version	Product data	Packaging
Order No.	1148290000	PCB plug-in connector, male header, open side, THT solder connection, 5.08 mm, Number of poles: 10, 180°, Solder pin length (l): 3.2 mm, tinned, black, Box	IEC: 400 V / 24 A UL: 300 V / 18.5 A	Box
GTIN (EAN)	4032248107773			
Qty.	50 pc(s).			
Type	SL 5.08HC/10/180 3.2SN ...	Version	Product data	Packaging
Order No.	1146530000	PCB plug-in connector, male header, open side, THT solder connection, 5.08 mm, Number of poles: 10, 180°, Solder pin length (l): 3.2 mm, tinned, orange, Box	IEC: 400 V / 24 A UL: 300 V / 18.5 A	Box
GTIN (EAN)	4032248933310			
Qty.	50 pc(s).			

SLS 5.08TB RF15

Male plugs with clamping-yoke screw wire-connect system. With clip-on feet for attaching the male plugs on rail. The male plugs provide space for labelling and can be coded.

General ordering data

Type	SLS 5.08/10/180TB RF15 ...	Version	Product data	Packaging
Order No.	1846080000	PCB plug-in connector, male plug, 5.08 mm, Number of poles: 10, 180°, Clamping yoke connection, Clamping range, max. : 3.31 mm², Box	IEC: 400 V / 21.5 A / 0.2 - 2.5 mm² UL: 300 V / 14 A / AWG 26 - AWG 12	Box
GTIN (EAN)	4032248362363			
Qty.	10 pc(s).			

**OMNIMATE Signal - series BL/SL 5.08
BLZP 5.08HC/10/180 SN BK BX**

Weidmüller Interface GmbH & Co. KG
Klingenbergstraße 26
D-32758 Detmold
Germany
Fon: +49 5231 14-0
Fax: +49 5231 14-292083
www.weidmueller.com

Mating connector (fully pluggable)
SL 5.08/90

Male connectors with 90° outlet direction. The solder pin length is optimised for wave flow soldering. The pin headers provide space for labelling and can be coded.

General ordering data

Type	SL 5.08/10/90 3.2SN OR ...	Version	Product data	Packaging
Order No.	1508860000	PCB plug-in connector, male header, open side, THT solder	IEC: 400 V / 18 A	Box
GTIN (EAN)	4008190089092	connection, 5.08 mm, Number of poles: 10, 90°, Solder pin length (l):	UL: 300 V / 15 A	
Qty.	50 pc(s).	3.2 mm, tinned, orange, Box		

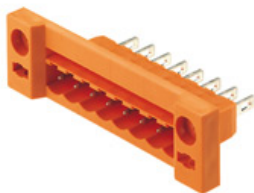
SLDF 5.08

Male connector for through-panel mounting with optional locking function. Internal connection as flat-blade or solder connection. These male connectors provide space for labelling and can be coded.

General ordering data

Type	SLDF 5.08 L/F 10 SN OR ...	Version	Product data	Packaging
Order No.	1599210000	PCB plug-in connector, male header, 5.08 mm, Number of poles: 10,	IEC: 400 V / 15 A	Box
GTIN (EAN)	4008190065522	180°, Flat-blade connection, Solder connection, Box	UL: 300 V / 10 A	
Qty.	24 pc(s).			

**OMNIMATE Signal - series BL/SL 5.08
BLZP 5.08HC/10/180 SN BK BX**

Weidmüller Interface GmbH & Co. KG
Klingenbergstraße 26
D-32758 Detmold
Germany
Fon: +49 5231 14-0
Fax: +49 5231 14-292083
www.weidmueller.com

Mating connector (fully pluggable)
SLDV 5.08/180B

Pin headers with solder pin length optimised for wave flow soldering. The male connectors provide space for labelling and can be coded. HC = High Current.

General ordering data

Type	SLD 5.08V/20/180B 3.2SN ...	Version	Product data	Packaging
Order No.	1726820000	PCB plug-in connector, male header, Dovetails for fixing blocks, THT	IEC: 400 V / 14 A	Box
GTIN (EAN)	4032248062706	solder connection, 5.08 mm, Number of poles: 20, 180°, Solder pin	UL: 300 V / 10 A	
Qty.	20 pc(s).	length (l): 3.2 mm, tinned, orange, Box		

SL 5.08/135B

Male connectors with 135° outlet direction. The solder pin length is optimised for wave flow soldering. The pin headers provide space for labelling and can be coded.

General ordering data

Type	SL 5.08/10/135B 3.2SN O ...	Version	Product data	Packaging
Order No.	1605610000	PCB plug-in connector, male header, Dovetails for fixing blocks, THT	IEC: 400 V / 17 A	Box
GTIN (EAN)	4008190178284	solder connection, 5.08 mm, Number of poles: 10, 135°, Solder pin	UL: 300 V / 15 A	
Qty.	50 pc(s).	length (l): 3.2 mm, tinned, orange, Box		

**OMNIMATE Signal - series BL/SL 5.08
BLZP 5.08HC/10/180 SN BK BX**

Weidmüller Interface GmbH & Co. KG
Klingenbergstraße 26
D-32758 Detmold
Germany
Fon: +49 5231 14-0
Fax: +49 5231 14-292083
www.weidmueller.com

Mating connector (fully pluggable)
SL 5.08/180

Male connectors with straight outlet direction. The solder pin length is optimised for wave flow soldering. The pin headers provide space for labelling and can be coded.

General ordering data

Type	SL 5.08/10/180 3.2SN OR ...	Version	Product data	Packaging
Order No.	1518060000	PCB plug-in connector, male header, open side, THT solder	IEC: 400 V / 18 A	Box
GTIN (EAN)	4008190122539	connection, 5.08 mm, Number of poles: 10, 180°, Solder pin length	UL: 300 V / 15 A	
Qty.	50 pc(s).	(l): 3.2 mm, tinned, orange, Box		

SLS 5.08/180 SN

Male plugs with clamping-yoke screw wire-connect system. The male plugs provide space for labelling and can be coded.

General ordering data

Type	SLS 5.08/10/180 SN OR BX	Version	Product data	Packaging
Order No.	1627170000	PCB plug-in connector, male plug, 5.08 mm, Number of poles: 10,	IEC: 400 V / 21.5 A / 0.2 - 2.5 mm ²	Box
GTIN (EAN)	4008190199685	180°, Clamping yoke connection, Clamping range, max. : 3.31 mm ² ,	UL: 300 V / 14 A / AWG 26 - AWG 12	
Qty.	36 pc(s).	Box		

**OMNIMATE Signal - series BL/SL 5.08
BLZP 5.08HC/10/180 SN BK BX**

Weidmüller Interface GmbH & Co. KG
Klingenbergstraße 26
D-32758 Detmold
Germany
Fon: +49 5231 14-0
Fax: +49 5231 14-292083
www.weidmueller.com

Mating connector (fully pluggable)

SL 5.08HC/90



Pin headers made from glass-fibre-reinforced plastic with 90° wire outlet; optimised for wave soldering. The flange variant (F) can be screwed onto the respective counter piece or the circuit board. There is no need for an extra screw to connect the circuit board when the solder flange (LF) version is used. This also protects the solder points from mechanical strain. All pin headers can be manually coded or ordered pre-coded. HC = High Current.

General ordering data

Type	SL 5.08HC/10/90 3.2SN B ...	Version	Product data	Packaging
Order No.	1155130000	PCB plug-in connector, male header, open side, THT solder connection, 5.08 mm, Number of poles: 10, 90°, Solder pin length (l): 3.2 mm, tinned, black, Box	IEC: 400 V / 24 A UL: 300 V / 18.5 A	Box
GTIN (EAN)	4050118050738			
Qty.	50 pc(s).			
Type	SL 5.08HC/10/90 3.2SN O ...	Version	Product data	Packaging
Order No.	1146900000	PCB plug-in connector, male header, open side, THT solder connection, 5.08 mm, Number of poles: 10, 90°, Solder pin length (l): 3.2 mm, tinned, orange, Box	IEC: 400 V / 24 A UL: 300 V / 18.5 A	Box
GTIN (EAN)	4050118051421			
Qty.	50 pc(s).			

OMNIMATE Signal - series BL/SL 5.08 BLZP 5.08HC/10/180 SN BK BX

Weidmüller Interface GmbH & Co. KG
 Klingenbergstraße 26
 D-32758 Detmold
 Germany
 Fon: +49 5231 14-0
 Fax: +49 5231 14-292083
 www.weidmueller.com

Accessories

Strain reliefs



For frequent load changes: the "trailer coupling" for plug-in connectors.

The strain relief can do more than just relieve the strain on conductors:

Simply clip onto the plug and

- bundle conductors
- guide cables
- use as a connection and disconnection aid

No damage to the connecting points, clear, tidy wiring and easy to handle.

User advantages: permanent heavy-duty connections for harsh industrial environments and convenient operation ensure improved system availability.

General ordering data

Type	BLZ 5.08 ZE04 BK BX	Version	Product data	Packaging
Order No.	1652130000		PCB plug-in connector, Accessories, Strain relief, black, Number of	Box
GTIN (EAN)	4008190401801		poles: 4	
Qty.	50 pc(s).			
Type	BLZ 5.08 ZE08 BK BX	Version	Product data	Packaging
Order No.	1652070000		PCB plug-in connector, Accessories, Strain relief, black, Number of	Box
GTIN (EAN)	4008190401740		poles: 8	
Qty.	50 pc(s).			
Type	BLZ 5.08 ZE08 OR BX	Version	Product data	Packaging
Order No.	1652050000		PCB plug-in connector, Accessories, Strain relief, orange, Number of	Box
GTIN (EAN)	4008190401726		poles: 8	
Qty.	50 pc(s).			
Type	BLZ 5.08 ZE04 OR BX	Version	Product data	Packaging
Order No.	1652110000		PCB plug-in connector, Accessories, Strain relief, orange, Number of	Box
GTIN (EAN)	4008190401788		poles: 4	
Qty.	50 pc(s).			

Crosshead screwdriver Phillips

Crosshead screwdriver, Phillips, SDK PH DIN 5262, ISO 8764/2-PH, output to ISO 8764-PH, ChromTop tip, SoftFinish grip



General ordering data

Type	SDK PH1	Version	Product data	Packaging
Order No.	9008480000		Screwdriver, Blade width (B): 4.5 mm, Blade length: 80 mm	
GTIN (EAN)	4032248056477			
Qty.	1 pc(s).			

**OMNIMATE Signal - series BL/SL 5.08
BLZP 5.08HC/10/180 SN BK BX**

Weidmüller Interface GmbH & Co. KG
Klingenbergstraße 26
D-32758 Detmold
Germany
Fon: +49 5231 14-0
Fax: +49 5231 14-292083
www.weidmueller.com

Accessories
Coding elements

**Only connects what is supposed to be connected:
the right connection at the right place.**

Coding elements and locking devices clearly assign connecting elements during the manufacturing process and operation

The coding elements and locking devices are inserted prior to assembly or during the cable assembly phase. The Weidmüller alternative: configure online using the variant configurator to precode prior to delivery. Incorrect assembly on the circuit board and incorrect plugging of connecting elements is no longer possible. The advantage: no troubleshooting during manufacture and no operational errors by the user.

General ordering data

Type	BLZ/SL KO BK BX	Version	Product data	Packaging
Order No.	1545710000	PCB plug-in connector, Accessories, Coding element, black, Number		Box
GTIN (EAN)	4008190087142	of poles: 1		
Qty.	50 pc(s).			
Type	BLZ/SL KO OR BX	Version	Product data	Packaging
Order No.	1573010000	PCB plug-in connector, Accessories, Coding element, orange, Number		Box
GTIN (EAN)	4008190048396	of poles: 1		
Qty.	100 pc(s).			

Crosshead screwdriver Pozidriv

Crosshead screwdriver, Pozidriv, SDK PZ DIN 5262, ISO 8764/2-PZ, output to ISO 8764/1-PZ, ChromTop tip, SoftFinish grip

General ordering data

Type	SDK PZ1	Version
Order No.	9008530000	Screwdriver, Blade width (B): 4.5 mm, Blade length: 80 mm
GTIN (EAN)	4032248056521	
Qty.	1 pc(s).	

OMNIMATE Signal - series BL/SL 5.08 BLZP 5.08HC/10/180 SN BK BX

Weidmüller Interface GmbH & Co. KG
 Klingenbergstraße 26
 D-32758 Detmold
 Germany
 Fon: +49 5231 14-0
 Fax: +49 5231 14-292083
 www.weidmueller.com

Accessories

Slotted screwdriver

Slotted screwdriver with rounded blade SD DIN 5265, ISO 2380/2, output to DIN 5264, ISO 2380/1. ChromTop tip, SoftFinish grip



General ordering data

Type	SDS 0.6X3.5X100	Version
Order No.	9008330000	Screwdriver, Blade width (B): 3.5 mm, Blade length: 100 mm, Blade thickness (A): 0.6 mm
GTIN (EAN)	4032248056286	
Qty.	1 pc(s).	

Slotted screwdriver

VDE insulated slot-head screwdriver, SDI DIN 7437, ISO 2380/2, drive output acc. to DIN 5264, ISO 2380/1. SoftFinish grip



General ordering data

Type	SDIS 0.6X3.5X100	Version
Order No.	9008390000	Screwdriver, Blade width (B): 3.5 mm, Blade length: 100 mm, Blade thickness (A): 0.6 mm
GTIN (EAN)	4032248056354	
Qty.	1 pc(s).	

MASSE OHNE TOLERANZ SIND KEINE PRUEFMASSE
 DIMS. WITHOUT TOLERANCE ARE NOT CONTROL DIMS.

DIE DEUTSCHE VERSION IST VERBINDLICH
 THE GERMAN VERSION IS BINDING

WEITERGABE SOWIE VERVIELFAELTIGUNG DIESES DOKUMENTS, VERWERTUNG UND MITTEILUNG SEINES INHALTS SIND VERBOTEN, SOWEIT NICHT AUSDRUECKLICH GESTATTET.
 ZUWIDERHANDLUNGEN VERPFLICHTEN ZU SCHADENERSATZ. ALLE RECHTE FUER DEN FALL DER PATENT-, GEBRAUCHSMUSTER- ODER GESCHMACKSMUSTEREINTRAGUNG VORBEHALTEN.
 THE REPRODUCTION, DISTRIBUTION AND UTILIZATION OF THIS DOCUMENT AS WELL AS THE COMMUNICATION OF ITS CONTENTS TO OTHERS WITHOUT EXPLICIT AUTHORIZATION IS PROHIBITED.
 OFFENDERS WILL BE HELD LIABLE FOR THE PAYMENT OF DAMAGES. WEIDMUELLER EXCLUSIVELY RESERVES THE RIGHT TO FILE FOR PATENTS, UTILITY MODELS OR DESIGNS.
 © WEIDMUELLER INTERFACE GmbH & Co.KG

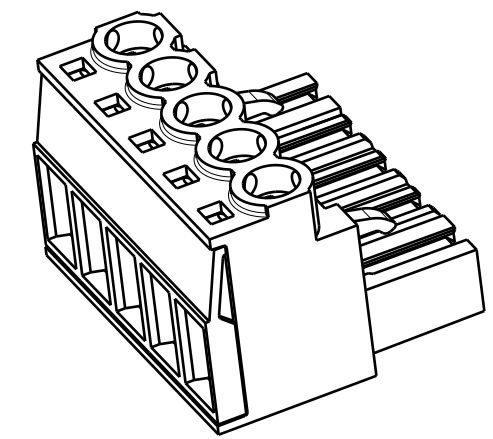
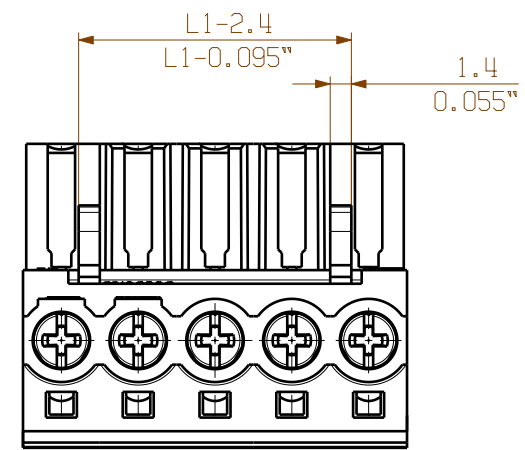
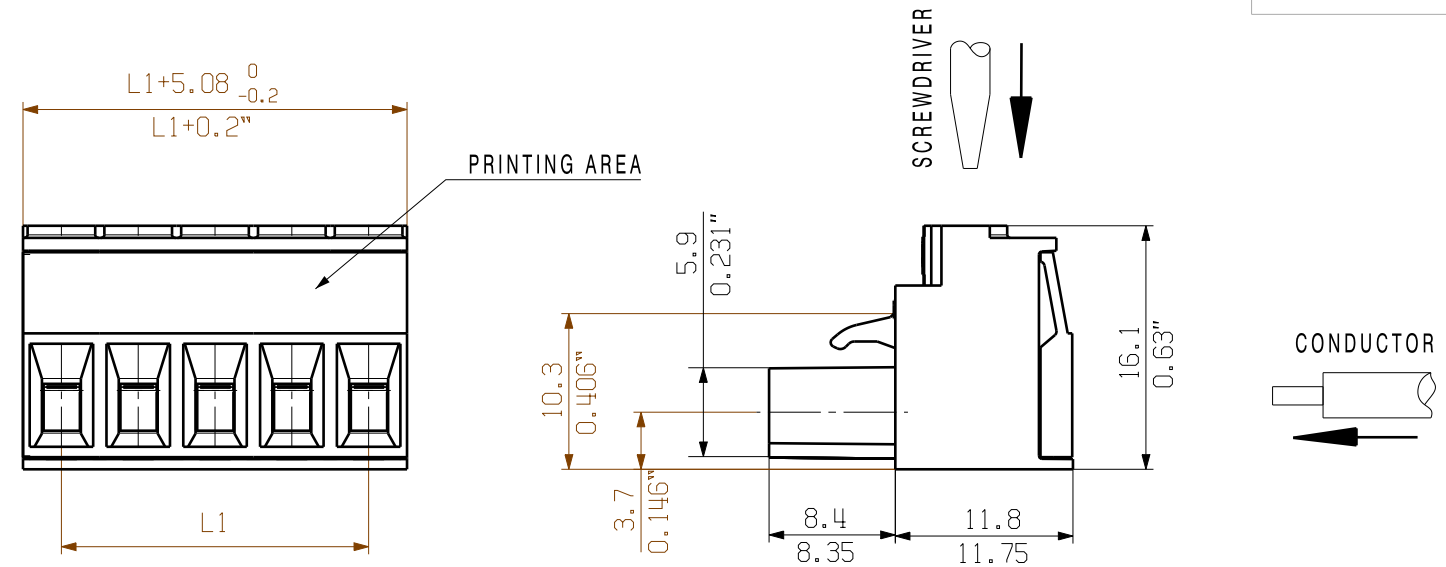

24	116,84	4,600
23	111,76	4,400
22	106,68	4,200
21	101,60	4,000
20	96,52	3,800
19	91,44	3,600
18	86,36	3,400
17	81,28	3,200
16	76,20	3,000
15	71,12	2,800
14	66,04	2,600
13	60,96	2,400
12	55,88	2,200
11	50,80	2,000
10	45,72	1,800
9	40,64	1,600
8	35,56	1,400
7	30,48	1,200
6	25,40	1,000
5	20,32	0,800
4	15,24	0,600
3	10,16	0,400
2	5,08	0,200
n	L1 [mm]	L1 [Inch]

For the mounting of PCBs, it should be noted that the rated data given in the catalogue relates only to the connection elements. The necessary creepage and clearance paths must be observed in connection with the respective applicant in accordance to VDE 0110. The current-carrying capacity and pitch tolerance is to be determined according to DIN IEC 326 part 3 very fine.

Weidmüller connectors are tested to the DIN VDE 0627 standard, and are valid for its field of application. Provided that the connectors are used to the intended purpose, all requirements with respect to the occurring of electrical, mechanical, thermic and corrosive stress will be satisfied.

SHOWN: BLZP 5.08HC/05/180

P = 5.08 RASTER/PITCH
 n = POLZAHL/NO OF POLES

	78302/4 08.04.15 HERTEL_S 01		CAT.NO.: .	
	MODIFICATION			
ISO 2768-m	DATE	NAME	DRAWING NO. C 39784 09	
	DRAWN	05.09.2005	KRUG_M	SHEET 01 OF 04 SHEETS
	RESPONSIBLE		KRUG_M	
	CHECKED	27.04.2015	HERTEL_S	
SCALE: 2/1	APPROVED	LANG_T	PRODUCT FILE: BLZP 5.0X WG 180 7157	
SUPERSEDES: .	BLZP 5.08HC/.../180... BUCHSENLEISTE SOCKET BLOCK			