

OMNIMATE Signal - series BL/SL 5.08 SL-SMT 5.08HC/12/180LF 1.5SN BK BX

Weidmüller Interface GmbH & Co. KG
Klingenbergstraße 26
D-32758 Detmold
Germany
Fon: +49 5231 14-0
Fax: +49 5231 14-292083
www.weidmueller.com



Similar to illustration

High-temperature-resistant pin header, packed in box or tape. On tape, with 1.5 mm solder pin, optimised for automatic assembly. 3.2 mm solder pin suitable for reflow and wave soldering. The pin headers provide space for labelling and can be coded. HC = High Current.

General ordering data

Type	SL-SMT 5.08HC/12/180LF 1.5SN BK BX
Order No.	1776462001
Version	PCB plug-in connector, male header, Solder flange, THT/THR solder connection, 5.08 mm, Number of poles: 12, 180°, Solder pin length (l): 1.5 mm, tinned, black, Box
GTIN (EAN)	4032248159345
Qty.	24 pc(s).
Product data	IEC: 400 V / 27.5 A UL: 300 V / 18.5 A
Packaging	Box

Creation date May 3, 2020 1:03:06 PM CEST

**OMNIMATE Signal - series BL/SL 5.08
SL-SMT 5.08HC/12/180LF 1.5SN BK BX**

Weidmüller Interface GmbH & Co. KG
 Klingenbergstraße 26
 D-32758 Detmold
 Germany
 Fon: +49 5231 14-0
 Fax: +49 5231 14-292083
 www.weidmueller.com

Technical data**Dimensions and weights**

Width	70.76 mm	Width (inches)	2.786 inch
Height	13.5 mm	Height (inches)	0.531 inch
Height of lowest version	12 mm	Depth	8.5 mm
Depth (inches)	0.335 inch	Net weight	6.18 g

System specifications

Product family	OMNIMATE Signal - series BL/SL 5.08	Type of connection	Board connection
Mounting onto the PCB	THT/THR solder connection	Pitch in mm (P)	5.08 mm
Pitch in inches (P)	0.2 inch	Outgoing elbow	180°
Number of poles	12	Number of solder pins per pole	1
Solder pin length (l)	1.5 mm	Solder pin length tolerance	0 / -0.3 mm
Tolerance of solder pin position	± 0.15 mm	Solder pin dimensions	d = 1.2 mm, Octagonal
Solder eyelet hole diameter (D)	1.5 mm	Solder eyelet hole diameter tolerance (D)	+ 0,1 mm
L1 in mm	55.88 mm	L1 in inches	2.2 inch
Number of rows	1	Pin series quantity	1
Volume resistance	≤ 5mΩ	Can be coded	Yes
Plugging cycles	25	Plugging force/pole, max.	9 N
Pulling force/pole, max.	7 N		

Material data

Insulating material	LCP GF	Colour	black
Colour chart (similar)	RAL 9011	Insulating material group	IIIa
Comparative Tracking Index (CTI)	≥ 175	Insulation strength	≥ 10 ⁸ Ω
Moisture Level (MSL)	1	UL 94 flammability rating	V-0
GWIT	930 °C	GWFI	960 °C
Contact material	CuMg	Contact surface	tinned
Layer structure of solder connection	1-3 μm Ni / 2-4 μm Sn matt	Layer structure of plug contact	1-3 μm Ni / 2-4 μm Sn matt
Storage temperature, min.	-25 °C	Storage temperature, max.	50 °C
Max. relative humidity during storage	70 %	Operating temperature, min.	-50 °C
Operating temperature, max.	100 °C	Temperature range, installation, min.	-30 °C
Temperature range, installation, max.	100 °C		

Rated data acc. to IEC

tested acc. to standard	IEC 60664-1, IEC 61984	Rated current, min. number of poles (Tu=20°C)	27.5 A
Rated current, max. number of poles (Tu=20°C)	19 A	Rated current, min. number of poles (Tu=40°C)	24 A
Rated current, max. number of poles (Tu=40°C)	16.5 A	Rated voltage for surge voltage class / pollution degree II/2	400 V
Rated voltage for surge voltage class / pollution degree III/2	320 V	Rated voltage for surge voltage class / pollution degree III/3	250 V
Rated impulse voltage for surge voltage class/ pollution degree II/2	4 kV	Rated impulse voltage for surge voltage class/ pollution degree III/2	4 kV
Rated impulse voltage for surge voltage class/ contamination degree III/3	4 kV		

OMNIMATE Signal - series BL/SL 5.08 SL-SMT 5.08HC/12/180LF 1.5SN BK BX

Weidmüller Interface GmbH & Co. KG
Klingenbergstraße 26
D-32758 Detmold
Germany
Fon: +49 5231 14-0
Fax: +49 5231 14-292083
www.weidmueller.com

Technical data

Rated data acc. to CSA

Institute (CSA)		Certificate No. (CSA)	200039-1176845
Rated voltage (Use group B / CSA)	300 V	Rated voltage (Use group D / CSA)	300 V
Rated current (Use group D / CSA)	18.5 A	Reference to approval values	Specifications are maximum values, details - see approval certificate.

Rated data acc. to UL 1059

Institute (UR)		Certificate No. (UR)	E60693
Rated voltage (Use group B / UL 1059)	300 V	Rated voltage (Use group D / UL 1059)	300 V
Rated current (Use group B / UL 1059)	18.5 A	Rated current (Use group D / UL 1059)	10 A
Reference to approval values	Specifications are maximum values, details - see approval certificate.		

Packing

Packaging	Box	VPE length	35 mm
VPE width	115 mm	VPE height	165 mm

Classifications

ETIM 6.0	EC002637	ETIM 7.0	EC002637
eClass 9.0	27-44-04-02	eClass 9.1	27-44-04-02
eClass 10.0	27-44-04-02	UNSPSC	30-21-18-10

Notes

Notes	<ul style="list-style-type: none"> • Gold-plated contact surfaces on request • Rated current related to rated cross-section & min. No. of poles. • Diameter of solder eyelet D = 1.4+0.1mm • Solder eyelet diameter D = 1.5 + 0.1 mm, from 9 poles • P on drawing = pitch • Rated data refer only to the component itself. Clearance and creepage distances to other components are to be designed in accordance with the relevant application standards.
IPC conformity	Conformity: The products are developed, manufactured and delivered according international recognized standards and norms and comply with the assured properties in the data sheet resp. fulfill decorative properties in accordance with IPC-A-610 "Class 2". Further claims on the products can be evaluated on request.

Data sheet

**OMNIMATE Signal - series BL/SL 5.08
SL-SMT 5.08HC/12/180LF 1.5SN BK BX**

Weidmüller Interface GmbH & Co. KG
Klingenbergstraße 26
D-32758 Detmold
Germany
Fon: +49 5231 14-0
Fax: +49 5231 14-292083
www.weidmueller.com

Technical data

Approvals

Approvals



ROHS

Conform

Downloads

Approval/Certificate/Document of Conformity	CB Certificate CB Testreport Declaration of the Manufacturer
Brochure/Catalogue	FL DRIVES EN MB SMT EN FL DRIVES DE MB DEVICE MANUF. EN CAT 2 PORTFOLIOGUIDE EN FL BUILDING SAFETY EN FL APPL LED LIGHTING EN FLIndustr.CONTROLS EN FL MACHINE SAFETY EN FL HEATING ELECTR EN FL APPL INVERTER EN FL_BASE_STATION_EN FL ELEVATOR EN FL POWER SUPPLY EN FL 72H SAMPLE SER EN PO OMNIMATE EN
Engineering Data	WSCAD
Engineering Data	STEP
White paper surface mount technology	Download Whitepaper

Data sheet

**OMNIMATE Signal - series BL/SL 5.08
SL-SMT 5.08HC/12/180LF 1.5SN BK BX**

Weidmüller Interface GmbH & Co. KG
Klingenbergstraße 26
D-32758 Detmold
Germany
Fon: +49 5231 14-0
Fax: +49 5231 14-292083
www.weidmueller.com

Drawings

Dimensional drawing

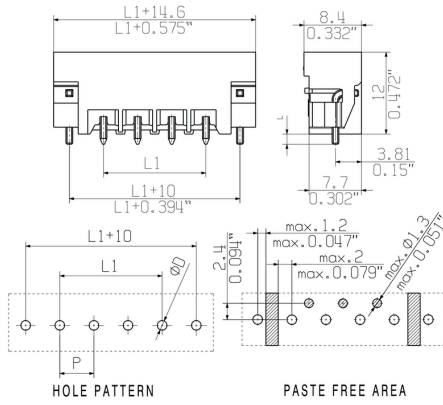

Product benefits

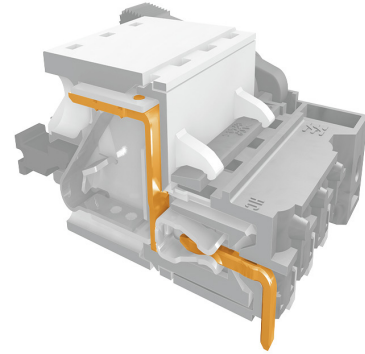

Safe power transmission

Product benefits

Proven properties



**OMNIMATE Signal - series BL/SL 5.08
SL-SMT 5.08HC/12/180LF 1.5SN BK BX**

Weidmüller Interface GmbH & Co. KG
Klingenbergstraße 26
D-32758 Detmold
Germany
Fon: +49 5231 14-0
Fax: +49 5231 14-292083
www.weidmueller.com

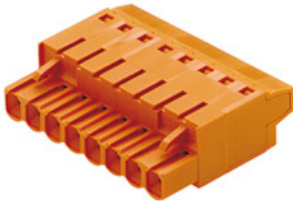
Mating connector (conditionally pluggable)
BLT 5.08HC/180B

Female plugs with TOP screw connection system for connecting wires with straight 180° outlet direction. The female connectors provide space for labelling and can be coded. HC = High Current.

General ordering data

Type	BLT 5.08HC/12/180B SN O ...	Version	Product data	Packaging
Order No.	1502860000	PCB plug-in connector, female plug, 5.08 mm, Number of poles: 12,	IEC: 400 V / 27 A / 0.2 - 2.5 mm ²	Box
GTIN (EAN)	4008190069155	180°, TOP connection, Clamping range, max. : 2.5 mm ² , Box	UL: 300 V / 17 A / AWG 26 - AWG 14	
Qty.	24 pc(s).			

BLL 5.08/180

Female header for PCB mounting. The solder pin length is optimised for wave flow soldering.

General ordering data

Type	BLL 5.08/12/180 4.5 SN ...	Version	Product data	Packaging
Order No.	1646350000	PCB plug-in connector, female header, closed side, THT solder	IEC: 400 V / 23 A	Box
GTIN (EAN)	4008190285692	connection, 5.08 mm, Number of poles: 12, 180°, Solder pin length	UL: 300 V / 15 A	
Qty.	50 pc(s).	(I): 4.5 mm, tinned, black, Box		
Type	BLL 5.08/12/180 4.5SN O ...	Version	Product data	Packaging
Order No.	1646240000	PCB plug-in connector, female header, closed side, THT solder	IEC: 400 V / 23 A	Box
GTIN (EAN)	4008190285586	connection, 5.08 mm, Number of poles: 12, 180°, Solder pin length	UL: 300 V / 15 A	
Qty.	50 pc(s).	(I): 4.5 mm, tinned, orange, Box		

**OMNIMATE Signal - series BL/SL 5.08
SL-SMT 5.08HC/12/180LF 1.5SN BK BX**

Weidmüller Interface GmbH & Co. KG
 Klingenbergstraße 26
 D-32758 Detmold
 Germany
 Fon: +49 5231 14-0
 Fax: +49 5231 14-292083
 www.weidmueller.com

Mating connector (conditionally pluggable)
BLZ 5.08/180

Female plugs with clamping-yoke screw for wire connection with straight (180°) outlet direction. The female plugs provide space for labelling and can be coded.

General ordering data

Type	BLZ 5.08/12/180 SN DKGN ...	Version	Product data	Packaging
Order No.	1527450000	PCB plug-in connector, female plug, 5.08 mm, Number of poles: 12,	IEC: 400 V / 19 A / 0.2 - 2.5 mm ²	Box
GTIN (EAN)	4008190146542	180°, Clamping yoke connection, Clamping range, max. : 3.31 mm ² ,	UL: 300 V / 15 A / AWG 26 - AWG 12	
Qty.	40 pc(s).	Box		
Type	BLZ 5.08/12/180 SN OR B ...	Version	Product data	Packaging
Order No.	1695761001	PCB plug-in connector, female plug, 5.08 mm, Number of poles: 12,	IEC: 400 V / 19 A / 0.2 - 2.5 mm ²	Box
GTIN (EAN)	4008190875527	180°, Clamping yoke connection, Clamping range, max. : 3.31 mm ² ,	UL: 300 V / 15 A / AWG 26 - AWG 12	
Qty.	30 pc(s).	Box		

**OMNIMATE Signal - series BL/SL 5.08
SL-SMT 5.08HC/12/180LF 1.5SN BK BX**

Weidmüller Interface GmbH & Co. KG
Klingenbergstraße 26
D-32758 Detmold
Germany
Fon: +49 5231 14-0
Fax: +49 5231 14-292083
www.weidmueller.com

Mating connector (fully pluggable)
BLZP 5.08HC/180F SN

Female plug with clamping-yoke screw system for connecting wires with straight (180°) outlet direction. The female connectors provide space for labelling and can be coded. Fastened by means of a flange or release latch. They also provide an integrated plus/minus screw, protection against faulty insertion of the wire, and they are delivered with open clamping yokes. HC = High Current.

General ordering data

Type	BLZP 5.08HC/12/180F SN ...	Version	Product data	Packaging
Order No.	1944430000	PCB plug-in connector, female plug, 5.08 mm, Number of poles: 12,	IEC: 400 V / 23 A / 0.2 - 4 mm ²	Box
GTIN (EAN)	4032248619009	180°, Clamping yoke connection, Clamping range, max. : 4 mm ² , Box	UL: 300 V / 20 A / AWG 26 - AWG 12	
Qty.	24 pc(s).			
Type	BLZP 5.08HC/12/180F SN ...	Version	Product data	Packaging
Order No.	1944190000	PCB plug-in connector, female plug, 5.08 mm, Number of poles: 12,	IEC: 400 V / 23 A / 0.2 - 4 mm ²	Box
GTIN (EAN)	4032248618774	180°, Clamping yoke connection, Clamping range, max. : 4 mm ² , Box	UL: 300 V / 20 A / AWG 26 - AWG 12	
Qty.	24 pc(s).			

BLF 5.08HC/180LR SN

Just as reliable as the millionfold proven original and featuring innovative details:
The BLF 5.08HC PUSH IN version of the BLZP 5.08HC female connector is not only different in terms of connection system; it also has a more compact design. Weidmüller's innovative PUSH IN spring connection system stands for the future of easy and tool-free wire connection. HC = High Current.
In terms of versatility, the BLF 5.08HC offers just as much as the version which served as a model:

- 3 tested-and-proven wire outlet directions provide the usual flexibility for application-specific design
- 4 flange variations and the patented release latch allow the locking concept to be based on the requirements of the user
- Use the BLF 5.08HC and SL 5.08HC plug combination to reach the max. rated specifications

General ordering data

Type	BLF 5.08HC/12/180LR SN ...	Version	Product data	Packaging
Order No.	1014480000	PCB plug-in connector, female plug, 5.08 mm, Number of poles: 12,	IEC: 400 V / 24 A / 0.2 - 2.5 mm ²	Box
GTIN (EAN)	4032248722884	180°, PUSH IN, Spring connection, Clamping range, max. : 3.31 mm ² , Box	UL: 300 V / 18.5 A / AWG 26 - AWG 12	
Qty.	24 pc(s).			
Type	BLF 5.08HC/12/180LR SN ...	Version	Product data	Packaging
Order No.	1014230000	PCB plug-in connector, female plug, 5.08 mm, Number of poles: 12,	IEC: 400 V / 24 A / 0.2 - 2.5 mm ²	Box
GTIN (EAN)	4032248723119	180°, PUSH IN, Spring connection, Clamping range, max. : 3.31 mm ² , Box	UL: 300 V / 18.5 A / AWG 26 - AWG 12	
Qty.	24 pc(s).			

**OMNIMATE Signal - series BL/SL 5.08
SL-SMT 5.08HC/12/180LF 1.5SN BK BX**

Weidmüller Interface GmbH & Co. KG
Klingenbergstraße 26
D-32758 Detmold
Germany
Fon: +49 5231 14-0
Fax: +49 5231 14-292083
www.weidmuller.com

Mating connector (fully pluggable)
BLF 5.08HC/270LR SN

Just as reliable as the millionfold proven original and featuring innovative details:
The BLF 5.08HC PUSH IN version of the BLZP 5.08HC female connector is not only different in terms of connection system; it also has a more compact design. Weidmüller's innovative PUSH IN spring connection system stands for the future of easy and tool-free wire connection. HC = High Current.
In terms of versatility, the BLF 5.08HC offers just as much as the version which served as a model:

- 3 tested-and-proven wire outlet directions provide the usual flexibility for application-specific design
- 4 flange variations and the patented release latch allow the locking concept to be based on the requirements of the user
- Use the BLF 5.08HC and SL 5.08HC plug combination to reach the max. rated specifications

General ordering data

Type	BLF 5.08HC/12/270LR SN ...	Version	Product data	Packaging
Order No.	1982410000	PCB plug-in connector, female plug, 5.08 mm, Number of poles: 12,	IEC: 400 V / 24 A / 0.2 - 2.5 mm ²	Box
GTIN (EAN)	4032248686506	270°, PUSH IN, Spring connection, Clamping range, max. : 3.31 mm ² ,	UL: 300 V / 18.5 A / AWG 26 - AWG	
Qty.	24 pc(s).	Box	12	
Type	BLF 5.08HC/12/270LR SN ...	Version	Product data	Packaging
Order No.	1983180000	PCB plug-in connector, female plug, 5.08 mm, Number of poles: 12,	IEC: 400 V / 24 A / 0.2 - 2.5 mm ²	Box
GTIN (EAN)	4032248687275	270°, PUSH IN, Spring connection, Clamping range, max. : 3.31 mm ² ,	UL: 300 V / 18.5 A / AWG 26 - AWG	
Qty.	24 pc(s).	Box	12	

BLZP 5.08HC/270F SN

Female plugs with clamping-yoke connection for connecting wires with a right-angle (90° or 270°) outlet direction. The female connectors provide space for labelling and can be coded. Fastened by means of a flange or release latch. They also provide an integrated plus/minus screw, protection against faulty insertion of the wire, and they are delivered with open clamping yokes. HC = High Current.

General ordering data

Type	BLZP 5.08HC/12/270F SN ...	Version	Product data	Packaging
Order No.	1950690000	PCB plug-in connector, female plug, 5.08 mm, Number of poles: 12,	IEC: 400 V / 23 A / 0.2 - 4 mm ²	Box
GTIN (EAN)	4032248628995	270°, Clamping yoke connection, Clamping range, max. : 4 mm ² , Box	UL: 300 V / 20 A / AWG 26 - AWG 12	
Qty.	24 pc(s).			
Type	BLZP 5.08HC/12/270F SN ...	Version	Product data	Packaging
Order No.	1950410000	PCB plug-in connector, female plug, 5.08 mm, Number of poles: 12,	IEC: 400 V / 23 A / 0.2 - 4 mm ²	Box
GTIN (EAN)	4032248628537	270°, Clamping yoke connection, Clamping range, max. : 4 mm ² , Box	UL: 300 V / 20 A / AWG 26 - AWG 12	
Qty.	24 pc(s).			

**OMNIMATE Signal - series BL/SL 5.08
SL-SMT 5.08HC/12/180LF 1.5SN BK BX**

Weidmüller Interface GmbH & Co. KG
Klingenbergstraße 26
D-32758 Detmold
Germany
Fon: +49 5231 14-0
Fax: +49 5231 14-292083
www.weidmueller.com

Mating connector (fully pluggable)
BLL 5.08/90FI

Female header for PCB mounting. The solder pin length is optimised for wave flow soldering.

General ordering data

Type	BLL 5.08/12/90FI 3.2SN ...	Version	Product data	Packaging
Order No.	1843850000	PCB plug-in connector, female header, Inverted flange, THT solder connection, 5.08 mm, Number of poles: 12, 90°, Solder pin length (l): 3.2 mm, tinned, orange, Box	IEC: 400 V / 23 A UL: 300 V / 15 A	Box
GTIN (EAN)	4032248355600			
Qty.	24 pc(s).			

BLT 5.08HC/180F

Female plugs with TOP screw connection system for connecting wires with straight outlet direction and screw flange. The female connectors provide space for labelling and can be coded. HC = High Current.

General ordering data

Type	BLT 5.08HC/12/180F SN B ...	Version	Product data	Packaging
Order No.	1844320000	PCB plug-in connector, female plug, 5.08 mm, Number of poles: 12, 180°, TOP connection, Clamping range, max. : 2.5 mm², Box	IEC: 400 V / 27 A / 0.2 - 2.5 mm² UL: 300 V / 17 A / AWG 26 - AWG 14	Box
GTIN (EAN)	4032248356256			
Qty.	24 pc(s).			
Type	BLT 5.08HC/12/180F SN O ...	Version	Product data	Packaging
Order No.	1844090000	PCB plug-in connector, female plug, 5.08 mm, Number of poles: 12, 180°, TOP connection, Clamping range, max. : 2.5 mm², Box	IEC: 400 V / 27 A / 0.2 - 2.5 mm² UL: 300 V / 17 A / AWG 26 - AWG 14	Box
GTIN (EAN)	4032248356010			
Qty.	24 pc(s).			

**OMNIMATE Signal - series BL/SL 5.08
SL-SMT 5.08HC/12/180LF 1.5SN BK BX**

Weidmüller Interface GmbH & Co. KG
Klingenbergstraße 26
D-32758 Detmold
Germany
Fon: +49 5231 14-0
Fax: +49 5231 14-292083
www.weidmueller.com

Mating connector (fully pluggable)
BLF 5.08HC/90LR SN

Just as reliable as the millionfold proven original and featuring innovative details:

The BLF 5.08HC PUSH IN version of the BLZP 5.08HC female connector is not only different in terms of connection system; it also has a more compact design. Weidmüller's innovative PUSH IN spring connection system stands for the future of easy and tool-free wire connection. HC = High Current.

In terms of versatility, the BLF 5.08HC offers just as much as the version which served as a model:

- 3 tested-and-proven wire outlet directions provide the usual flexibility for application-specific design
- 4 flange variations and the patented release latch allow the locking concept to be based on the requirements of the user
- Use the BLF 5.08HC and SL 5.08HC plug combination to reach the max. rated specifications

General ordering data

Type	BLF 5.08HC/12/90LR SN B ...	Version	Product data	Packaging
Order No.	1000510001	PCB plug-in connector, female plug, 5.08 mm, Number of poles: 12,	IEC: 400 V / 24 A / 0.2 - 2.5 mm ²	Box
GTIN (EAN)	4032248690473	90°, PUSH IN, Spring connection, Clamping range, max. : 3.31 mm ² ,	UL: 300 V / 18.5 A / AWG 26 - AWG	
Qty.	24 pc(s).	Box	12	
Type	BLF 5.08HC/12/90LR SN O ...	Version	Product data	Packaging
Order No.	1002380000	PCB plug-in connector, female plug, 5.08 mm, Number of poles: 12,	IEC: 400 V / 24 A / 0.2 - 2.5 mm ²	Box
GTIN (EAN)	4032248694549	90°, PUSH IN, Spring connection, Clamping range, max. : 3.31 mm ² ,	UL: 300 V / 18.5 A / AWG 26 - AWG	
Qty.	24 pc(s).	Box	12	

BLF 5.08HC/180F SN

Just as reliable as the millionfold proven original and featuring innovative details:

The BLF 5.08HC PUSH IN version of the BLZP 5.08HC female connector is not only different in terms of connection system; it also has a more compact design. Weidmüller's innovative PUSH IN spring connection system stands for the future of easy and tool-free wire connection. HC = High Current.

In terms of versatility, the BLF 5.08HC offers just as much as the version which served as a model:

- 3 tested-and-proven wire outlet directions provide the usual flexibility for application-specific design
- 4 flange variations and the patented release latch allow the locking concept to be based on the requirements of the user
- Use the BLF 5.08HC and SL 5.08HC plug combination to reach the max. rated specifications

General ordering data

Type	BLF 5.08HC/12/180F SN O ...	Version	Product data	Packaging
Order No.	1013190000	PCB plug-in connector, female plug, 5.08 mm, Number of poles: 12,	IEC: 400 V / 24 A / 0.2 - 2.5 mm ²	Box
GTIN (EAN)	4032248720941	180°, PUSH IN, Spring connection, Clamping range, max. : 3.31 mm ² ,	UL: 300 V / 18.5 A / AWG 26 - AWG	
Qty.	24 pc(s).	Box	12	

**OMNIMATE Signal - series BL/SL 5.08
SL-SMT 5.08HC/12/180LF 1.5SN BK BX**

Weidmüller Interface GmbH & Co. KG
Klingenbergstraße 26
D-32758 Detmold
Germany
Fon: +49 5231 14-0
Fax: +49 5231 14-292083
www.weidmueller.com

Mating connector (fully pluggable)

Type	BLF 5.08HC/12/180F SN B ...	Version	Product data	Packaging
Order No.	1012750000	PCB plug-in connector, female plug, 5.08 mm, Number of poles: 12,	IEC: 400 V / 24 A / 0.2 - 2.5 mm ²	Box
GTIN (EAN)	4032248720392	180°, PUSH IN, Spring connection, Clamping range, max. : 3.31 mm ² ,	UL: 300 V / 18.5 A / AWG 26 - AWG	
Qty.	24 pc(s).	Box	12	

BLT 5.08HC/180LR

Female plugs with TOP screw connection system for connecting wires with straight wire outlet and release latch mechanism. The female connectors provide space for labelling and can be coded. HC = High Current.

General ordering data

Type	BLT 5.08HC/12/180LR SN ...	Version	Product data	Packaging
Order No.	1894230000	PCB plug-in connector, female plug, 5.08 mm, Number of poles: 12,	IEC: 400 V / 27 A / 0.2 - 2.5 mm ²	Box
GTIN (EAN)	4032248508570	180°, TOP connection, Clamping range, max. : 2.5 mm ² , Box	UL: 300 V / 17 A / AWG 26 - AWG 14	
Qty.	24 pc(s).			
Type	BLT 5.08HC/12/180LR SN ...	Version	Product data	Packaging
Order No.	1890320000	PCB plug-in connector, female plug, 5.08 mm, Number of poles: 12,	IEC: 400 V / 27 A / 0.2 - 2.5 mm ²	Box
GTIN (EAN)	4032248498802	180°, TOP connection, Clamping range, max. : 2.5 mm ² , Box	UL: 300 V / 17 A / AWG 26 - AWG 14	
Qty.	24 pc(s).			

BLZP 5.08HC/90LR

Female plugs with clamping-yoke connection for connecting wires with a right-angle (90° or 270°) outlet direction. The female connectors provide space for labelling and can be coded. Fastened by means of a flange or release latch. They also provide an integrated plus/minus screw, protection against faulty insertion of the wire, and they are delivered with open clamping yokes. HC = High Current.

General ordering data

Type	BLZP 5.08HC/12/90LR SN ...	Version	Product data	Packaging
Order No.	1087130000	PCB plug-in connector, female plug, 5.08 mm, Number of poles: 12,	IEC: 400 V / 23 A / 0.2 - 4 mm ²	Box
GTIN (EAN)	4032248854219	90°, Clamping yoke connection, Clamping range, max. : 4 mm ² , Box	UL: 300 V / 20 A / AWG 26 - AWG 12	
Qty.	24 pc(s).			
Type	BLZP 5.08HC/12/90LR SN ...	Version	Product data	Packaging
Order No.	1087350000	PCB plug-in connector, female plug, 5.08 mm, Number of poles: 12,	IEC: 400 V / 23 A / 0.2 - 4 mm ²	Box
GTIN (EAN)	4032248854233	90°, Clamping yoke connection, Clamping range, max. : 4 mm ² , Box	UL: 300 V / 20 A / AWG 26 - AWG 12	
Qty.	24 pc(s).			

**OMNIMATE Signal - series BL/SL 5.08
SL-SMT 5.08HC/12/180LF 1.5SN BK BX**

Weidmüller Interface GmbH & Co. KG
Klingenbergstraße 26
D-32758 Detmold
Germany
Fon: +49 5231 14-0
Fax: +49 5231 14-292083
www.weidmuller.com

Mating connector (fully pluggable)
BLZP 5.08HC/270LR SN

Female plugs with clamping-yoke connection for connecting wires with a right-angle (90° or 270°) outlet direction. The female connectors provide space for labelling and can be coded. Fastened by means of a flange or release latch. They also provide an integrated plus/minus screw, protection against faulty insertion of the wire, and they are delivered with open clamping yokes. HC = High Current.

General ordering data

Type	BLZP 5.08HC/12/270LR SN ...	Version	Product data	Packaging
Order No.	1947630000	PCB plug-in connector, female plug, 5.08 mm, Number of poles: 12,	IEC: 400 V / 23 A / 0.2 - 4 mm ²	Box
GTIN (EAN)	4032248624027	270°, Clamping yoke connection, Clamping range, max. : 4 mm ² , Box	UL: 300 V / 20 A / AWG 26 - AWG 12	
Qty.	24 pc(s).			
Type	BLZP 5.08HC/12/270LR SN ...	Version	Product data	Packaging
Order No.	1947860000	PCB plug-in connector, female plug, 5.08 mm, Number of poles: 12,	IEC: 400 V / 23 A / 0.2 - 4 mm ²	Box
GTIN (EAN)	4032248624355	270°, Clamping yoke connection, Clamping range, max. : 4 mm ² , Box	UL: 300 V / 20 A / AWG 26 - AWG 12	
Qty.	24 pc(s).			

BLZP 5.08HC/90F SN

Female plugs with clamping-yoke connection for connecting wires with a right-angle (90° or 270°) outlet direction. The female connectors provide space for labelling and can be coded. Fastened by means of a flange or release latch. They also provide an integrated plus/minus screw, protection against faulty insertion of the wire, and they are delivered with open clamping yokes. HC = High Current.

General ordering data

Type	BLZP 5.08HC/12/90F SN O ...	Version	Product data	Packaging
Order No.	1949900000	PCB plug-in connector, female plug, 5.08 mm, Number of poles: 12,	IEC: 400 V / 23 A / 0.2 - 4 mm ²	Box
GTIN (EAN)	4032248627837	90°, Clamping yoke connection, Clamping range, max. : 4 mm ² , Box	UL: 300 V / 20 A / AWG 26 - AWG 12	
Qty.	24 pc(s).			
Type	BLZP 5.08HC/12/90F SN B ...	Version	Product data	Packaging
Order No.	1950140000	PCB plug-in connector, female plug, 5.08 mm, Number of poles: 12,	IEC: 400 V / 23 A / 0.2 - 4 mm ²	Box
GTIN (EAN)	4032248628070	90°, Clamping yoke connection, Clamping range, max. : 4 mm ² , Box	UL: 300 V / 20 A / AWG 26 - AWG 12	
Qty.	24 pc(s).			

**OMNIMATE Signal - series BL/SL 5.08
SL-SMT 5.08HC/12/180LF 1.5SN BK BX**

Weidmüller Interface GmbH & Co. KG
Klingenbergstraße 26
D-32758 Detmold
Germany
Fon: +49 5231 14-0
Fax: +49 5231 14-292083
www.weidmueller.com

Mating connector (fully pluggable)
BLZP 5.08HC/180LR SN

Female plug with clamping-yoke screw system for connecting wires with straight (180°) outlet direction. The female connectors provide space for labelling and can be coded. Fastened by means of a flange or release latch. They also provide an integrated plus/minus screw, protection against faulty insertion of the wire, and they are delivered with open clamping yokes. HC = High Current.

General ordering data

Type	BLZP 5.08HC/12/180LR SN ...	Version	Product data	Packaging
Order No.	1944930000	PCB plug-in connector, female plug, 5.08 mm, Number of poles: 12,	IEC: 400 V / 23 A / 0.2 - 4 mm ²	Box
GTIN (EAN)	4032248620005	180°, Clamping yoke connection, Clamping range, max. : 4 mm ² , Box	UL: 300 V / 20 A / AWG 26 - AWG 12	
Qty.	24 pc(s).			
Type	BLZP 5.08HC/12/180LR SN ...	Version	Product data	Packaging
Order No.	1945160000	PCB plug-in connector, female plug, 5.08 mm, Number of poles: 12,	IEC: 400 V / 23 A / 0.2 - 4 mm ²	Box
GTIN (EAN)	4032248620302	180°, Clamping yoke connection, Clamping range, max. : 4 mm ² , Box	UL: 300 V / 20 A / AWG 26 - AWG 12	
Qty.	24 pc(s).			

BLF 5.08HC/270F SN

Just as reliable as the millionfold proven original and featuring innovative details:
The BLF 5.08HC PUSH IN version of the BLZP 5.08HC female connector is not only different in terms of connection system; it also has a more compact design. Weidmüller's innovative PUSH IN spring connection system stands for the future of easy and tool-free wire connection. HC = High Current.
In terms of versatility, the BLF 5.08HC offers just as much as the version which served as a model:

- 3 tested-and-proven wire outlet directions provide the usual flexibility for application-specific design
- 4 flange variations and the patented release latch allow the locking concept to be based on the requirements of the user
- Use the BLF 5.08HC and SL 5.08HC plug combination to reach the max. rated specifications

General ordering data

Type	BLF 5.08HC/12/270F SN O ...	Version	Product data	Packaging
Order No.	1982990000	PCB plug-in connector, female plug, 5.08 mm, Number of poles: 12,	IEC: 400 V / 24 A / 0.2 - 2.5 mm ²	Box
GTIN (EAN)	4032248687084	270°, PUSH IN, Spring connection, Clamping range, max. : 3.31 mm ² , Box	UL: 300 V / 18.5 A / AWG 26 - AWG 12	
Qty.	24 pc(s).			
Type	BLF 5.08HC/12/270F SN B ...	Version	Product data	Packaging
Order No.	1982220000	PCB plug-in connector, female plug, 5.08 mm, Number of poles: 12,	IEC: 400 V / 24 A / 0.2 - 2.5 mm ²	Box
GTIN (EAN)	4032248686315	270°, PUSH IN, Spring connection, Clamping range, max. : 3.31 mm ² , Box	UL: 300 V / 18.5 A / AWG 26 - AWG 12	
Qty.	24 pc(s).			

**OMNIMATE Signal - series BL/SL 5.08
SL-SMT 5.08HC/12/180LF 1.5SN BK BX**

Weidmüller Interface GmbH & Co. KG
 Klingenbergstraße 26
 D-32758 Detmold
 Germany
 Fon: +49 5231 14-0
 Fax: +49 5231 14-292083
 www.weidmueller.com

Mating connector (fully pluggable)
BLF 5.08HC/90F SN

Just as reliable as the millionfold proven original and featuring innovative details:

The BLF 5.08HC PUSH IN version of the BLZP 5.08HC female connector is not only different in terms of connection system; it also has a more compact design. Weidmüller's innovative PUSH IN spring connection system stands for the future of easy and tool-free wire connection. HC = High Current.

In terms of versatility, the BLF 5.08HC offers just as much as the version which served as a model:

- 3 tested-and-proven wire outlet directions provide the usual flexibility for application-specific design
- 4 flange variations and the patented release latch allow the locking concept to be based on the requirements of the user
- Use the BLF 5.08HC and SL 5.08HC plug combination to reach the max. rated specifications

General ordering data

Type	BLF 5.08HC/12/90F SN BK ...	Version	Product data	Packaging
Order No.	1000320001	PCB plug-in connector, female plug, 5.08 mm, Number of poles: 12,	IEC: 400 V / 24 A / 0.2 - 2.5 mm ²	Box
GTIN (EAN)	4032248690282	90°, PUSH IN, Spring connection, Clamping range, max. : 3.31 mm ² ,	UL: 300 V / 18.5 A / AWG 26 - AWG	
Qty.	24 pc(s).	Box	12	
Type	BLF 5.08HC/12/90F SN OR ...	Version	Product data	Packaging
Order No.	1002190000	PCB plug-in connector, female plug, 5.08 mm, Number of poles: 12,	IEC: 400 V / 24 A / 0.2 - 2.5 mm ²	Box
GTIN (EAN)	4032248694341	90°, PUSH IN, Spring connection, Clamping range, max. : 3.31 mm ² ,	UL: 300 V / 18.5 A / AWG 26 - AWG	
Qty.	24 pc(s).	Box	12	

OMNIMATE Signal - series BL/SL 5.08 SL-SMT 5.08HC/12/180LF 1.5SN BK BX

Weidmüller Interface GmbH & Co. KG
 Klingenbergstraße 26
 D-32758 Detmold
 Germany
 Fon: +49 5231 14-0
 Fax: +49 5231 14-292083
 www.weidmueller.com

Accessories

Coding elements



Only connects what is supposed to be connected: the right connection at the right place.

Coding elements and locking devices clearly assign connecting elements during the manufacturing process and operation

The coding elements and locking devices are inserted prior to assembly or during the cable assembly phase. The Weidmüller alternative: configure online using the variant configurator to precode prior to delivery.

Incorrect assembly on the circuit board and incorrect plugging of connecting elements is no longer possible. The advantage: no troubleshooting during manufacture and no operational errors by the user.

General ordering data

Type	BLZ/SL KO OR BX	Version	Product data	Packaging
Order No.	1573010000	PCB plug-in connector, Accessories, Coding element, orange, Number		Box
GTIN (EAN)	4008190048396	of poles: 1		
Qty.	100 pc(s).			
Type	BLZ/SL KO BK BX	Version	Product data	Packaging
Order No.	1545710000	PCB plug-in connector, Accessories, Coding element, black, Number		Box
GTIN (EAN)	4008190087142	of poles: 1		
Qty.	50 pc(s).			

Additional accessories



No task is too small when creating the perfect solution. br />

Connections form just one part of the overall process. Small details are often the key to the perfect solution in applications where potentials are tested, grouped or even isolated.

A system is not a system without small but useful details:

- Test plugs - ensure reliable pick-up from diagnostic sockets
- Cross-connectors - ensure a stable electrical distribution contact directly at the connection
- Compartment partition elements - divide a large number of male connectors into several separate socket connector channels
- Locks and clips - optional vibration-resistant clip-on connection or mounting for male and female connectors

In tandem with the manufacturing process and application - more accessories = smaller workload

General ordering data

Type	SL AT SW	Version	Product data	Packaging
Order No.	1770240000	PCB plug-in connector, Accessories, Spacer, black, Number of poles: 1		Box
GTIN (EAN)	4032248117710			
Qty.	100 pc(s).			

Data sheet

**OMNIMATE Signal - series BL/SL 5.08
SL-SMT 5.08HC/12/180LF 1.5SN BK BX**

Weidmüller Interface GmbH & Co. KG
 Klingenbergstraße 26
 D-32758 Detmold
 Germany
 Fon: +49 5231 14-0
 Fax: +49 5231 14-292083
 www.weidmueller.com

Accessories

Type	SL AT OR	Version	Product data	Packaging
Order No.	1598300000	PCB plug-in connector, Accessories, Spacer, orange, Number of poles:		Box
GTIN (EAN)	4008190189266	1		
Qty.	100 pc(s).			

The reproduction, distribution and utilization of this document as well as the communication of its contents to others without explicit authorization is prohibited. Offenders will be held liable for the payment of damages. Weidmüller exclusively reserves the right to file for patents, utility models or designs.

© Weidmüller Interface GmbH & Co. KG

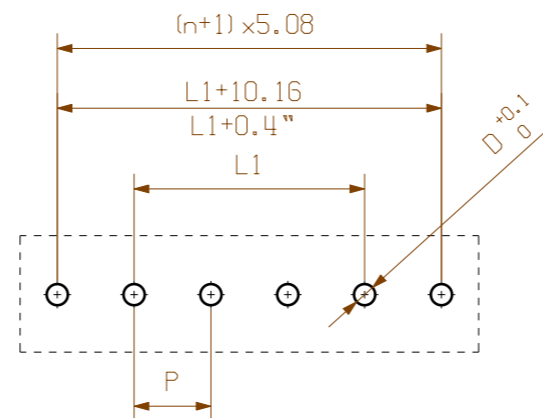
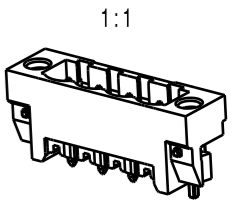
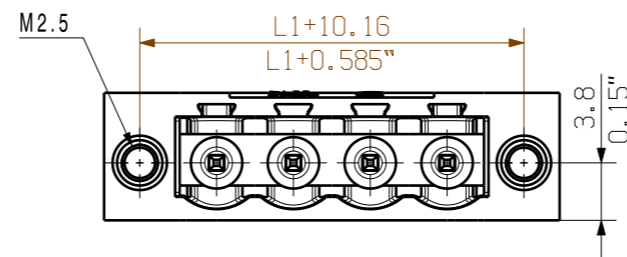
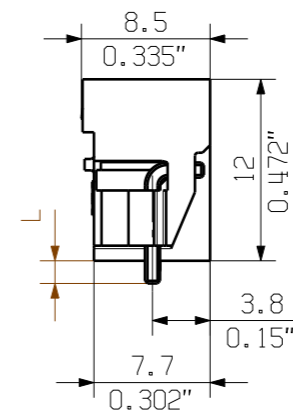
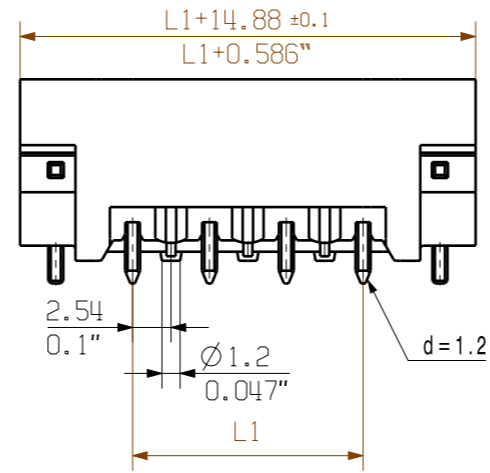

HOLE PATTERN

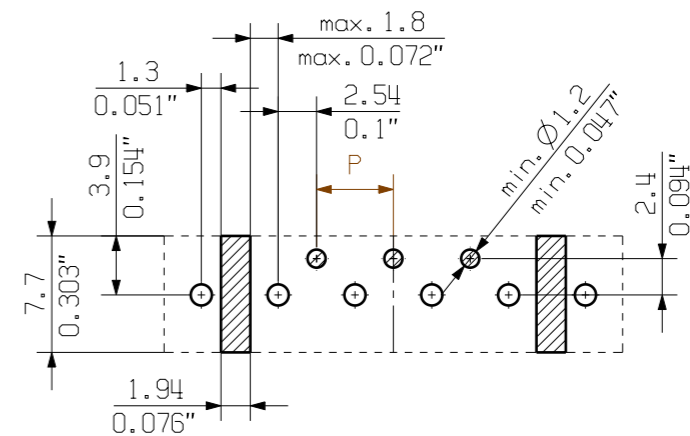

PASTE-FREE AREA

D = 1.5/0.059" (REFLOW SOLDERING)
RECOMMENDATION FOR AUTOMATIC ASSEMBLY

n = POLZAH/ NO OF POLES

P = RASTER/PITCH

SHOWN: SL-SMT 5.08HC/04/180 LF

1.5	0,0	n	L1 [mm]	L1 [Inch]
	-0,3			
3.2	0,1	24	116,84	4,600
	-0,3	23	111,76	4,400
4.5	0,1	22	106,68	4,200
	-0,3	21	101,60	4,000
		20	96,52	3,800
		19	91,44	3,600
		18	86,36	3,400
		17	81,28	3,200
		16	76,20	3,000
		15	71,12	2,800
		14	66,04	2,600
		13	60,96	2,400
		12	55,88	2,200
		11	50,80	2,000
		10	45,72	1,800
		9	40,64	1,600
		8	35,56	1,400
		7	30,48	1,200
		6	25,40	1,000
		5	20,32	0,800
		4	15,24	0,600
		3	10,16	0,400
		2	5,08	0,200

For the mounting of PCBs, it should be noted that the rated data relates only to the PCB components alone. The necessary creepage and clearance paths must be observed in connection with the respective applicant in accordance to IEC 664 / VDE 0110. The current-carrying capacity and pitch tolerance is to be determined according to DIN IEC 326 part 3 very fine.

Weidmüller PCB components are tested to the DIN EN 61984 standard, and are valid for its field of application. Provided that the components are used to the intended purpose, all requirements with respect to the occurring of electrical, mechanical, thermic and corrosive stress will be satisfied.

	DIN ISO 2768-m	106339/4 30.07.18 HERTEL_S 01		Cat.no.: .	
		Modification			
	Drawn	30.11.2007	HELIS_MA	C 34148 23	
	Responsible		HERTEL_S	Drawing no. Issue no.	
	Checked	01.08.2018	KOCH_JG	Sheet 03 of 04 sheets	
Supersedes: .	Approved		LANG_T	SL-SMT 5.08HC/.../180... STIFTLISTE MALE HEADER	
			Product file: SL-SMT 5.08HC		7280

Recommended wave soldering profiles

Weidmüller Interface GmbH & Co. KG
 Klängenbergstraße 16
 D-32758 Detmold
 Germany
 Fon: +49 5231 14-0
 Fax: +49 5231 14-292083
 www.weidmueller.com

Single Wave:



Double Wave:

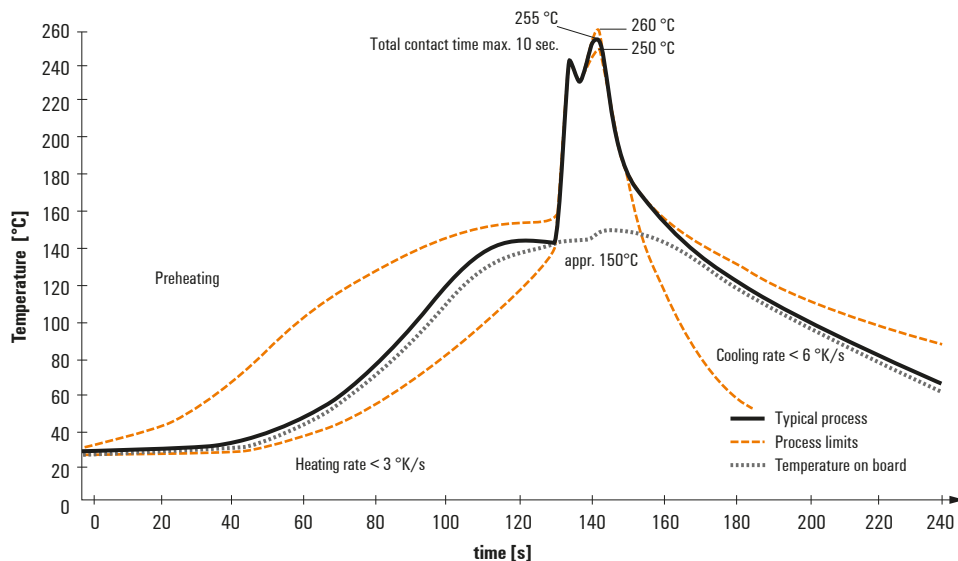

Wave soldering profiles

Wired connection elements should be processed in accordance with the DIN EN 61760-1 standard. We have included two recommendations for practical wave soldering profiles, with which Weidmüller PCB terminals and connectors are qualified.

When choosing a suitable profile for your application, the following factors also need to be considered:

- PCB thickness
- Proportion of Cu in the layers
- Single/double-sided assembly
- Product range
- Heating and cooling rates

The single and double wave profiles each indicate the recommended operating range, including the maximum soldering temperature of 260°C. In practice, the maximum soldering temperature is quite often well below the above maximum profile.

Recommended reflow soldering profile

Weidmüller Interface GmbH & Co. KG
 Klingenbergstraße 16
 D-32758 Detmold
 Germany
 Fon: +49 5231 14-0
 Fax: +49 5231 14-292083
 www.weidmueller.com



Reflow soldering profile

The perfect soldering profile for SMT Surface Mount Technology is one the most exiting question in SMT production. But there are more than one correct answer: The diagram of temperature-on-time is related to processing features of solder paste and to maximum load of components.

We have to consider the following parameters:

- Time for pre heating
- Maximum temperature
- Time above melting point
- Time for cooling
- Maximum heating rate
- Maximum cooling rate

We recommend a typical solder profile with associated process limits. With preheating components and board are prepared smoothly for the solder phase. Heating rate is typically $\leq +3\text{K/s}$. In parallel the solder paste is ‚activated‘. The time above melting point of 217°C the paste gets liquid and components and boards begin to connect. The maximum temperature of 245°C to 254°C should stay between 10 and 40 seconds. In the cooling phase at $\geq -6\text{K/s}$ solder is cured. Board and components cool down while avoiding cold cracks.