

OMNIMATE Signal - series BL/SL 5.08 SL-SMT 5.08HC/08/90G 1.5SN BK BX

Weidmüller Interface GmbH & Co. KG
Klingenbergstraße 26
D-32758 Detmold
Germany
Fon: +49 5231 14-0
Fax: +49 5231 14-292083
www.weidmueller.com



Similar to illustration

High-temperature-resistant pin header, packed in box or tape. On tape, with 1.5 mm solder pin, optimised for automatic assembly. 3.2 mm solder pin suitable for reflow and wave soldering. The pin headers provide space for labelling and can be coded. HC = High Current.

General ordering data

Type	SL-SMT 5.08HC/08/90G 1.5SN BK BX
Order No.	1775062001
Version	PCB plug-in connector, male header, closed side, THT/THR solder connection, 5.08 mm, Number of poles: 8, 90°, Solder pin length (l): 1.5 mm, tinned, black, Box
GTIN (EAN)	4032248156528
Qty.	50 pc(s).
Product data	IEC: 400 V / 27.5 A UL: 300 V / 18.5 A
Packaging	Box

Creation date May 3, 2020 12:35:05 PM CEST

**OMNIMATE Signal - series BL/SL 5.08
SL-SMT 5.08HC/08/90G 1.5SN BK BX**

Weidmüller Interface GmbH & Co. KG
 Klingenbergstraße 26
 D-32758 Detmold
 Germany
 Fon: +49 5231 14-0
 Fax: +49 5231 14-292083
 www.weidmueller.com

Technical data**Dimensions and weights**

Width	43.84 mm	Width (inches)	1.726 inch
Height	9.9 mm	Height (inches)	0.39 inch
Height of lowest version	8.4 mm	Depth	12 mm
Depth (inches)	0.472 inch	Net weight	3.94 g

System specifications

Product family	OMNIMATE Signal - series BL/SL 5.08	Type of connection	Board connection
Mounting onto the PCB	THT/THR solder connection	Pitch in mm (P)	5.08 mm
Pitch in inches (P)	0.2 inch	Outgoing elbow	90°
Number of poles	8	Number of solder pins per pole	1
Solder pin length (l)	1.5 mm	Solder pin length tolerance	0 / -0.3 mm
Tolerance of solder pin position	± 0.1 mm	Solder pin dimensions	d = 1.2 mm, Octagonal
Solder eyelet hole diameter (D)	1.4 mm	Solder eyelet hole diameter tolerance (D)	+ 0,1 mm
L1 in mm	35.56 mm	L1 in inches	1.4 inch
Number of rows	1	Pin series quantity	1
Volume resistance	≤ 5mΩ	Can be coded	Yes
Plugging cycles	25	Plugging force/pole, max.	9 N
Pulling force/pole, max.	7 N		

Material data

Insulating material	LCP GF	Colour	black
Colour chart (similar)	RAL 9011	Insulating material group	IIIa
Comparative Tracking Index (CTI)	≥ 175	Insulation strength	≥ 10 ⁸ Ω
Moisture Level (MSL)	1	UL 94 flammability rating	V-0
GWIT	930 °C	GWFI	960 °C
Contact material	CuMg	Contact surface	tinned
Layer structure of solder connection	1-3 μm Ni / 2-4 μm Sn matt	Layer structure of plug contact	1-3 μm Ni / 2-4 μm Sn matt
Storage temperature, min.	-25 °C	Storage temperature, max.	50 °C
Max. relative humidity during storage	70 %	Operating temperature, min.	-50 °C
Operating temperature, max.	100 °C	Temperature range, installation, min.	-30 °C
Temperature range, installation, max.	100 °C		

Rated data acc. to IEC

tested acc. to standard	IEC 60664-1, IEC 61984	Rated current, min. number of poles (Tu=20°C)	27.5 A
Rated current, max. number of poles (Tu=20°C)	19 A	Rated current, min. number of poles (Tu=40°C)	24 A
Rated current, max. number of poles (Tu=40°C)	16.5 A	Rated voltage for surge voltage class / pollution degree II/2	400 V
Rated voltage for surge voltage class / pollution degree III/2	320 V	Rated voltage for surge voltage class / pollution degree III/3	250 V
Rated impulse voltage for surge voltage class/ pollution degree II/2	4 kV	Rated impulse voltage for surge voltage class/ pollution degree III/2	4 kV
Rated impulse voltage for surge voltage class/ contamination degree III/3	4 kV		

**OMNIMATE Signal - series BL/SL 5.08
SL-SMT 5.08HC/08/90G 1.5SN BK BX**

Weidmüller Interface GmbH & Co. KG
 Klingenbergstraße 26
 D-32758 Detmold
 Germany
 Fon: +49 5231 14-0
 Fax: +49 5231 14-292083
 www.weidmueller.com

Technical data**Rated data acc. to CSA**

Institute (CSA)



Certificate No. (CSA)

200039-1176845

Rated voltage (Use group B / CSA) 300 V

Rated voltage (Use group D / CSA) 300 V

Rated current (Use group B / CSA) 18.5 A

Rated current (Use group D / CSA) 18.5 A

Reference to approval values
 Specifications are maximum values, details - see approval certificate.

Rated data acc. to UL 1059

Institute (UR)



Certificate No. (UR)

E60693

Rated voltage (Use group B / UL 1059) 300 V

Rated voltage (Use group D / UL 1059) 300 V

Rated current (Use group B / UL 1059) 18.5 A

Rated current (Use group D / UL 1059) 10 A

Reference to approval values
 Specifications are maximum values, details - see approval certificate.

Packing

Packaging	Box	VPE length	35 mm
VPE width	115 mm	VPE height	165 mm

Classifications

ETIM 6.0	EC002637	ETIM 7.0	EC002637
eClass 9.0	27-44-04-02	eClass 9.1	27-44-04-02
eClass 10.0	27-44-04-02	UNSPSC	30-21-18-10

Notes

Notes	<ul style="list-style-type: none"> • Gold-plated contact surfaces on request • Rated current related to rated cross-section & min. No. of poles. • Diameter of solder eyelet D = 1.4+0.1mm • Solder eyelet diameter D = 1.5 + 0.1 mm, from 9 poles • P on drawing = pitch • Rated data refer only to the component itself. Clearance and creepage distances to other components are to be designed in accordance with the relevant application standards.
-------	---

IPC conformity	Conformity: The products are developed, manufactured and delivered according international recognized standards and norms and comply with the assured properties in the data sheet resp. fulfill decorative properties in accordance with IPC-A-610 "Class 2". Further claims on the products can be evaluated on request.
----------------	--

Data sheet

**OMNIMATE Signal - series BL/SL 5.08
SL-SMT 5.08HC/08/90G 1.5SN BK BX**

Weidmüller Interface GmbH & Co. KG
Klingenbergstraße 26
D-32758 Detmold
Germany
Fon: +49 5231 14-0
Fax: +49 5231 14-292083
www.weidmueller.com

Technical data

Approvals

Approvals



ROHS

Conform

Downloads

Approval/Certificate/Document of Conformity

[Declaration of the Manufacturer](#)

Brochure/Catalogue

- [FL DRIVES EN](#)
- [MB SMT EN](#)
- [FL DRIVES DE](#)
- [MB DEVICE MANUF. EN](#)
- [CAT 2 PORTFOLIOGUIDE EN](#)
- [FL BUILDING SAFETY EN](#)
- [FL APPL LED LIGHTING EN](#)
- [FLIndustr.CONTROLS EN](#)
- [FL MACHINE SAFETY EN](#)
- [FL HEATING ELECTR EN](#)
- [FL APPL_INVERTER EN](#)
- [FL_BASE_STATION_EN](#)
- [FL ELEVATOR EN](#)
- [FL POWER SUPPLY EN](#)
- [FL 72H SAMPLE SER EN](#)
- [PO OMNIMATE EN](#)

Engineering Data

[EPLAN, WSCAD](#)

Engineering Data

[STEP](#)

White paper surface mount technology

[Download Whitepaper](#)

Data sheet

**OMNIMATE Signal - series BL/SL 5.08
SL-SMT 5.08HC/08/90G 1.5SN BK BX**

Weidmüller Interface GmbH & Co. KG
Klingenbergstraße 26
D-32758 Detmold
Germany
Fon: +49 5231 14-0
Fax: +49 5231 14-292083
www.weidmueller.com

Drawings

Dimensional drawing

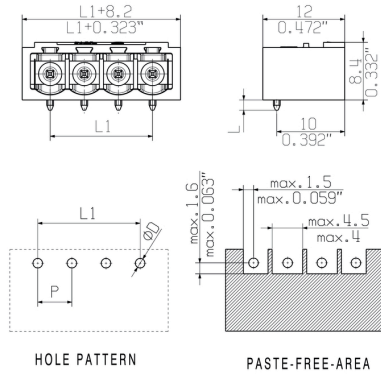

Graph

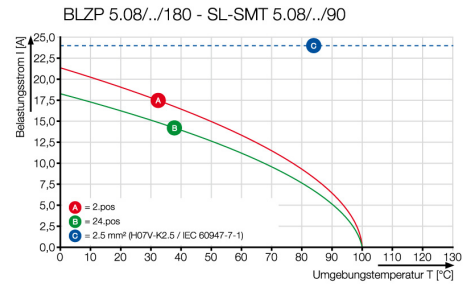

Graph

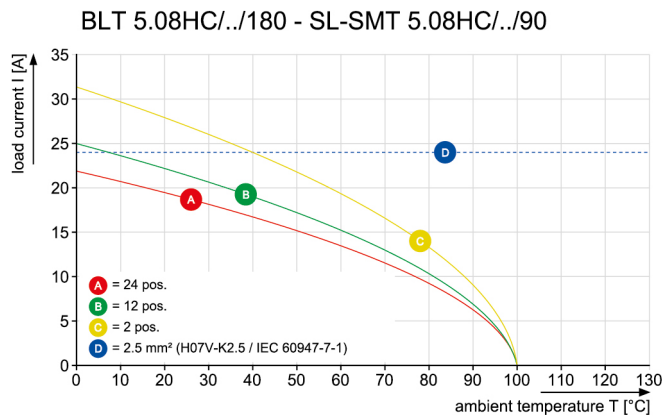

Product benefits Safe power transmission
Proven properties



**OMNIMATE Signal - series BL/SL 5.08
SL-SMT 5.08HC/08/90G 1.5SN BK BX**

Weidmüller Interface GmbH & Co. KG
Klingenbergstraße 26
D-32758 Detmold
Germany
Fon: +49 5231 14-0
Fax: +49 5231 14-292083
www.weidmueller.com

Mating connector (conditionally pluggable)

BLT 5.08HC/180B

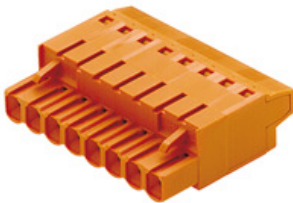

Female plugs with TOP screw connection system for connecting wires with straight 180° outlet direction. The female connectors provide space for labelling and can be coded. HC = High Current.

General ordering data

Type	BLT 5.08HC/08/180B SN O ...	Version	Product data	Packaging
Order No.	1502460000	PCB plug-in connector, female plug, 5.08 mm, Number of poles: 8,	IEC: 400 V / 27 A / 0.2 - 2.5 mm ²	Box
GTIN (EAN)	4008190147334	180°, TOP connection, Clamping range, max. : 2.5 mm ² , Box	UL: 300 V / 17 A / AWG 26 - AWG 14	
Qty.	42 pc(s).			

**OMNIMATE Signal - series BL/SL 5.08
SL-SMT 5.08HC/08/90G 1.5SN BK BX**

Weidmüller Interface GmbH & Co. KG
Klingenbergstraße 26
D-32758 Detmold
Germany
Fon: +49 5231 14-0
Fax: +49 5231 14-292083
www.weidmueller.com

Mating connector (fully pluggable)
BLDF 5.08/180 SN

The powerful daisy-chain solution for high-performance signal bus applications is also suitable for 400V auxiliary power chains with 18.5A current-carrying capacity. The large clamping capacity (up to 2.5mm² wire cross-sections) is particularly beneficial for long bus cables or high currents because of the low voltage drop. Four flange variations, including the patented release latch, allow for user-friendly unplugging designs.

General ordering data

Type	BLDF 5.08/08/180 SN OR ...	Version	Product data	Packaging
Order No.	1001210000	PCB plug-in connector, female plug, 5.08 mm, Number of poles: 8,	IEC: 400 V / 20.8 A / 0.2 - 2.5 mm ²	Box
GTIN (EAN)	4032248817573	180°, PUSH IN, Spring connection, Clamping range, max. : 3.31 mm ² ,	UL: 300 V / 18.5 A / AWG 12 - AWG	
Qty.	28 pc(s).	Box	26	
Type	BLDF 5.08/08/180 SN BK ...	Version	Product data	Packaging
Order No.	1000920000	PCB plug-in connector, female plug, 5.08 mm, Number of poles: 8,	IEC: 400 V / 20.8 A / 0.2 - 2.5 mm ²	Box
GTIN (EAN)	4032248817092	180°, PUSH IN, Spring connection, Clamping range, max. : 3.31 mm ² ,	UL: 300 V / 18.5 A / AWG 12 - AWG	
Qty.	28 pc(s).	Box	26	

BLC 5.08R

Female plugs with crimp wire connection system. The female plugs provide space for labelling and can be coded.

General ordering data

Type	BLC 5.08/08/180R OR BX	Version	Product data	Packaging
Order No.	1610550000	PCB plug-in connector, female plug, 5.08 mm, Number of poles: 8,	IEC: 400 V / 21 A	Box
GTIN (EAN)	4008190080563	180°, Crimp connection, Clamping range, max. : 2.5 mm ² ,	UL: 300 V / 10 A / AWG 26 - AWG 14	
Qty.	50 pc(s).	Box		
Type	BLC 5.08/08/180R BK BX	Version	Product data	Packaging
Order No.	1712020000	PCB plug-in connector, female plug, 5.08 mm, Number of poles: 8,	IEC: 400 V / 21 A	Box
GTIN (EAN)	4008190935030	180°, Crimp connection, Clamping range, max. : 2.5 mm ² ,	UL: 300 V / 10 A / AWG 26 - AWG 14	
Qty.	50 pc(s).			

**OMNIMATE Signal - series BL/SL 5.08
SL-SMT 5.08HC/08/90G 1.5SN BK BX**

Weidmüller Interface GmbH & Co. KG
Klingenbergstraße 26
D-32758 Detmold
Germany
Fon: +49 5231 14-0
Fax: +49 5231 14-292083
www.weidmueller.com

Mating connector (fully pluggable)
BLL 5.08/180

Female header for PCB mounting. The solder pin length is optimised for wave flow soldering.

General ordering data

Type	Version	Product data	Packaging
BLL 5.08/08/180 3.2 SN ...	PCB plug-in connector, female header, closed side, THT solder connection, 5.08 mm, Number of poles: 8, 180°, Solder pin length (l): 3.2 mm, tinned, orange, Box	IEC: 400 V / 23 A UL: 300 V / 15 A	Box
Order No. 1630770000			
GTIN (EAN) 4008190204198			
Qty. 42 pc(s).			
BLL 5.08/08/180 4.5 SN ...	PCB plug-in connector, female header, closed side, THT solder connection, 5.08 mm, Number of poles: 8, 180°, Solder pin length (l): 4.5 mm, tinned, black, Box	IEC: 400 V / 23 A UL: 300 V / 15 A	Box
Order No. 1646310000			
GTIN (EAN) 4008190285654			
Qty. 42 pc(s).			

BLZ 5.08/180

Female plugs with clamping-yoke screw for wire connection with straight (180°) outlet direction. The female plugs provide space for labelling and can be coded.

General ordering data

Type	Version	Product data	Packaging
BLZ 5.08/08/180 SN OR B ...	PCB plug-in connector, female plug, 5.08 mm, Number of poles: 8, 180°, Clamping yoke connection, Clamping range, max.: 3.31 mm², Box	IEC: 400 V / 19 A / 0.2 - 2.5 mm² UL: 300 V / 15 A / AWG 26 - AWG 12	Box
Order No. 1653451001			
GTIN (EAN) 4008190404826			
Qty. 42 pc(s).			
BLZ 5.08/08/180 SN DKG ...	PCB plug-in connector, female plug, 5.08 mm, Number of poles: 8, 180°, Clamping yoke connection, Clamping range, max.: 3.31 mm², Box	IEC: 400 V / 19 A / 0.2 - 2.5 mm² UL: 300 V / 15 A / AWG 26 - AWG 12	Box
Order No. 1527050000			
GTIN (EAN) 4008190191160			
Qty. 50 pc(s).			
BLZ 5.08/08/180 SN GY BX	PCB plug-in connector, female plug, 5.08 mm, Number of poles: 8, 180°, Clamping yoke connection, Clamping range, max.: 3.31 mm², Box	IEC: 400 V / 19 A / 0.2 - 2.5 mm² UL: 300 V / 15 A / AWG 26 - AWG 12	Box
Order No. 1527000000			
GTIN (EAN) 4008190017613			
Qty. 50 pc(s).			

**OMNIMATE Signal - series BL/SL 5.08
SL-SMT 5.08HC/08/90G 1.5SN BK BX**

Weidmüller Interface GmbH & Co. KG
Klingenbergstraße 26
D-32758 Detmold
Germany
Fon: +49 5231 14-0
Fax: +49 5231 14-292083
www.weidmueller.com

Mating connector (fully pluggable)
BLF 5.08HC/270 SN

Just as reliable as the millionfold proven original and featuring innovative details:
The BLF 5.08HC PUSH IN version of the BLZP 5.08HC female connector is not only different in terms of connection system; it also has a more compact design. Weidmüller's innovative PUSH IN spring connection system stands for the future of easy and tool-free wire connection. HC = High Current.
In terms of versatility, the BLF 5.08HC offers just as much as the version which served as a model:

- 3 tested-and-proven wire outlet directions provide the usual flexibility for application-specific design
- 4 flange variations and the patented release latch allow the locking concept to be based on the requirements of the user
- Use the BLF 5.08HC and SL 5.08HC plug combination to reach the max. rated specifications

General ordering data

Type	BLF 5.08HC/08/270 SN OR ...	Version	Product data	Packaging
Order No.	1982760000	PCB plug-in connector, female plug, 5.08 mm, Number of poles: 8,	IEC: 400 V / 24 A / 0.2 - 2.5 mm ²	Box
GTIN (EAN)	4032248686858	270°, PUSH IN, Spring connection, Clamping range, max. : 3.31 mm ² , UL: 300 V / 18.5 A / AWG 26 - AWG		
Qty.	42 pc(s).	Box	12	
Type	BLF 5.08HC/08/270 SN BK ...	Version	Product data	Packaging
Order No.	1981990000	PCB plug-in connector, female plug, 5.08 mm, Number of poles: 8,	IEC: 400 V / 24 A / 0.2 - 2.5 mm ²	Box
GTIN (EAN)	4032248684687	270°, PUSH IN, Spring connection, Clamping range, max. : 3.31 mm ² , UL: 300 V / 18.5 A / AWG 26 - AWG		
Qty.	42 pc(s).	Box	12	

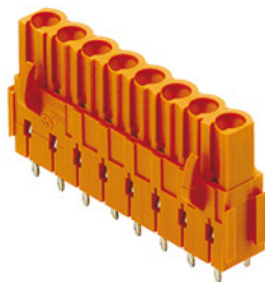
BLL 5.08/180B

Female header for PCB mounting. The solder pin length is optimised for wave flow soldering.

General ordering data

Type	BLL 5.08/08/180B 3.2SN ...	Version	Product data	Packaging
Order No.	1682790000	PCB plug-in connector, female header, Dovetails for fixing blocks, THT	IEC: 400 V / 23 A	Box
GTIN (EAN)	4008190474553	solder connection, 5.08 mm, Number of poles: 8, 180°, Solder pin	UL: 300 V / 15 A	
Qty.	42 pc(s).	length (l): 3.2 mm, tinned, orange, Box		

**OMNIMATE Signal - series BL/SL 5.08
SL-SMT 5.08HC/08/90G 1.5SN BK BX**

Weidmüller Interface GmbH & Co. KG
Klingenbergstraße 26
D-32758 Detmold
Germany
Fon: +49 5231 14-0
Fax: +49 5231 14-292083
www.weidmueller.com

Mating connector (fully pluggable)
BLZF 5.08/180

Female plugs with tension-clamp wire connection system, straight 180° outlet direction. The female plugs provide space for labelling and can be coded.

General ordering data

Type	BLZF 5.08/08/180 SN DKG ...	Version	Product data	Packaging
Order No.	1707980000	PCB plug-in connector, female plug, 5.08 mm, Number of poles: 8,	IEC: 400 V / 17 A / 0.2 - 2.5 mm ²	Box
GTIN (EAN)	4008190317393	180°, Tension-clamp connection, Clamping range, max. : 3.31 mm ² ,	UL: 300 V / 15 A / AWG 26 - AWG 12	
Qty.	42 pc(s).	Box		

BLZP 5.08HC/225B SN

Clamping-yoke connection with right-angled (90° or 270°) or angled (225°) outlet direction. The female connectors provide space for labelling and can be coded. Fastened by means of a flange or release latch. They also provide an integrated plus/minus screw, protection against faulty insertion of the wire, and they are delivered with open clamping yokes. HC = High Current.

General ordering data

Type	BLZP 5.08HC/08/225B SN ...	Version	Product data	Packaging
Order No.	1945810000	PCB plug-in connector, female plug, 5.08 mm, Number of poles: 8,	IEC: 400 V / 17.5 A / 0.2 - 4 mm ²	Box
GTIN (EAN)	4032248621286	225°, Clamping yoke connection, Clamping range, max. : 4 mm ² , Box	UL: 300 V / 15 A / AWG 26 - AWG 12	
Qty.	42 pc(s).			

Type	BLZP 5.08HC/08/225B SN ...	Version	Product data	Packaging
Order No.	1946040000	PCB plug-in connector, female plug, 5.08 mm, Number of poles: 8,	IEC: 400 V / 17.5 A / 0.2 - 4 mm ²	Box
GTIN (EAN)	4032248621576	225°, Clamping yoke connection, Clamping range, max. : 4 mm ² , Box	UL: 300 V / 15 A / AWG 26 - AWG 12	
Qty.	42 pc(s).			

**OMNIMATE Signal - series BL/SL 5.08
SL-SMT 5.08HC/08/90G 1.5SN BK BX**

Weidmüller Interface GmbH & Co. KG
Klingenbergstraße 26
D-32758 Detmold
Germany
Fon: +49 5231 14-0
Fax: +49 5231 14-292083
www.weidmuller.com

Mating connector (fully pluggable)
BLZP 5.08HC/90 SN

Female plugs with clamping-yoke connection for connecting wires with a right-angle (90° or 270°) outlet direction. The female connectors provide space for labelling and can be coded. Fastened by means of a flange or release latch. They also provide an integrated plus/minus screw, protection against faulty insertion of the wire, and they are delivered with open clamping yokes. HC = High Current.

General ordering data

Type	BLZP 5.08HC/08/90 SN OR ...	Version	Product data	Packaging
Order No.	1948060000	PCB plug-in connector, female plug, 5.08 mm, Number of poles: 8,	IEC: 400 V / 23 A / 0.2 - 4 mm ²	Box
GTIN (EAN)	4032248624287	90°, Clamping yoke connection, Clamping range, max. : 4 mm ² , Box	UL: 300 V / 20 A / AWG 26 - AWG 12	
Qty.	42 pc(s).			
Type	BLZP 5.08HC/08/90 SN BK ...	Version	Product data	Packaging
Order No.	1948300000	PCB plug-in connector, female plug, 5.08 mm, Number of poles: 8,	IEC: 400 V / 23 A / 0.2 - 4 mm ²	Box
GTIN (EAN)	4032248624829	90°, Clamping yoke connection, Clamping range, max. : 4 mm ² , Box	UL: 300 V / 20 A / AWG 26 - AWG 12	
Qty.	42 pc(s).			

BLDT 5.08B

Female plugs with two clamping-yoke screw connections per pole for wire connections with 90° and 270° outlet directions. The female plugs provide space for labelling and can be coded.

General ordering data

Type	BLDT 5.08/08/-B SN BK BX	Version	Product data	Packaging
Order No.	1673840000	PCB plug-in connector, female plug, 5.08 mm, Number of poles: 8,	IEC: 400 V / 14 A / 0.2 - 2.5 mm ²	Box
GTIN (EAN)	4008190435578	180°, Clamping yoke connection, Clamping range, max. : 3.31 mm ² ,	UL: 300 V / 10 A / AWG 26 - AWG 12	
Qty.	50 pc(s).	Box		
Type	BLDT 5.08/08/-B SN OR BX	Version	Product data	Packaging
Order No.	1651800000	PCB plug-in connector, female plug, 5.08 mm, Number of poles: 8,	IEC: 400 V / 14 A / 0.2 - 2.5 mm ²	Box
GTIN (EAN)	4008190400484	180°, Clamping yoke connection, Clamping range, max. : 3.31 mm ² ,	UL: 300 V / 10 A / AWG 26 - AWG 12	
Qty.	35 pc(s).	Box		

**OMNIMATE Signal - series BL/SL 5.08
SL-SMT 5.08HC/08/90G 1.5SN BK BX**

Weidmüller Interface GmbH & Co. KG
Klingenbergstraße 26
D-32758 Detmold
Germany
Fon: +49 5231 14-0
Fax: +49 5231 14-292083
www.weidmueller.com

Mating connector (fully pluggable)
BLF 5.08HC/90 SN

Just as reliable as the millionfold proven original and featuring innovative details:
The BLF 5.08HC PUSH IN version of the BLZP 5.08HC female connector is not only different in terms of connection system; it also has a more compact design. Weidmüller's innovative PUSH IN spring connection system stands for the future of easy and tool-free wire connection. HC = High Current.
In terms of versatility, the BLF 5.08HC offers just as much as the version which served as a model:

- 3 tested-and-proven wire outlet directions provide the usual flexibility for application-specific design
- 4 flange variations and the patented release latch allow the locking concept to be based on the requirements of the user
- Use the BLF 5.08HC and SL 5.08HC plug combination to reach the max. rated specifications

General ordering data

Type	BLF 5.08HC/08/90 SN OR ...	Version	Product data	Packaging
Order No.	1001590000	PCB plug-in connector, female plug, 5.08 mm, Number of poles: 8,	IEC: 400 V / 24 A / 0.2 - 2.5 mm ²	Box
GTIN (EAN)	4032248693399	90°, PUSH IN, Spring connection, Clamping range, max. : 3.31 mm ² ,	UL: 300 V / 18.5 A / AWG 26 - AWG	
Qty.	42 pc(s).	Box	12	
Type	BLF 5.08HC/08/90 SN BK ...	Version	Product data	Packaging
Order No.	1000090001	PCB plug-in connector, female plug, 5.08 mm, Number of poles: 8,	IEC: 400 V / 24 A / 0.2 - 2.5 mm ²	Box
GTIN (EAN)	4032248690022	90°, PUSH IN, Spring connection, Clamping range, max. : 3.31 mm ² ,	UL: 300 V / 18.5 A / AWG 26 - AWG	
Qty.	42 pc(s).	Box	12	

BLZ 5.00/270



Female plugs with clamping-yoke screw for wire connection with 270° outlet direction. The female plugs provide space for labelling and can be coded.

General ordering data

Type	BLZ 5.00/08/270 SN DKGN ...	Version	Product data	Packaging
Order No.	1649950000	PCB plug-in connector, female plug, 5.00 mm, Number of poles: 8,	IEC: 400 V / 15 A / 0.5 - 2.5 mm ²	Box
GTIN (EAN)	4008190296537	270°, Clamping yoke connection, Clamping range, max. : 3.31 mm ² ,	UL: 300 V / 10 A / AWG 26 - AWG 12	
Qty.	42 pc(s).	Box		
Type	BLZ 5.00/15/270 SN BK B ...	Version	Product data	Packaging
Order No.	1724270000	PCB plug-in connector, female plug, 5.00 mm, Number of poles: 15,	IEC: 400 V / 15 A / 0.5 - 2.5 mm ²	Box
GTIN (EAN)	4008190369361	270°, Clamping yoke connection, Clamping range, max. : 3.31 mm ² ,	UL: 300 V / 10 A / AWG 26 - AWG 12	
Qty.	24 pc(s).	Box		

**OMNIMATE Signal - series BL/SL 5.08
SL-SMT 5.08HC/08/90G 1.5SN BK BX**

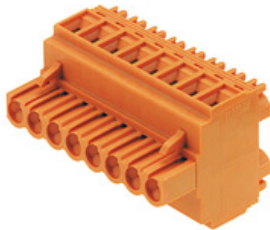
Weidmüller Interface GmbH & Co. KG
Klingenbergstraße 26
D-32758 Detmold
Germany
Fon: +49 5231 14-0
Fax: +49 5231 14-292083
www.weidmuller.com

Mating connector (fully pluggable)
BLDT 5.08

Female plugs with two clamping-yoke screw connections per pole for wire connections with 90° and 270° outlet directions. The female plugs provide space for labelling and can be coded.

General ordering data

Type	BLDT 5.08/08/- SN BK BX	Version	Product data	Packaging
Order No.	1660770000	PCB plug-in connector, female plug, 5.08 mm, Number of poles: 8,	IEC: 400 V / 14 A / 0.2 - 2.5 mm ²	Box
GTIN (EAN)	4008190417222	180°, Clamping yoke connection, Clamping range, max. : 3.31 mm ² ,	UL: 300 V / 10 A / AWG 26 - AWG 12	
Qty.	35 pc(s).	Box		
Type	BLDT 5.08/08/- SN OR BX	Version	Product data	Packaging
Order No.	1644790000	PCB plug-in connector, female plug, 5.08 mm, Number of poles: 8,	IEC: 400 V / 14 A / 0.2 - 2.5 mm ²	Box
GTIN (EAN)	4008190284008	180°, Clamping yoke connection, Clamping range, max. : 3.31 mm ² ,	UL: 300 V / 10 A / AWG 26 - AWG 12	
Qty.	35 pc(s).	Box		

BLZP 5.08HC/225 SN



Clamping-yoke connection with right-angled (90° or 270°) or angled (225°) outlet direction. The female connectors provide space for labelling and can be coded. Fastened by means of a flange or release latch. The also provide an integrated plus/minus screw, protection against faulty insertion of the wire, and they are delivered with open clamping yokes. HC = High Current.

General ordering data

Type	BLZP 5.08HC/08/225 SN B ...	Version	Product data	Packaging
Order No.	1946620000	PCB plug-in connector, female plug, 5.08 mm, Number of poles: 8,	IEC: 400 V / 17.5 A / 0.2 - 4 mm ²	Box
GTIN (EAN)	4032248622399	225°, Clamping yoke connection, Clamping range, max. : 4 mm ² , Box	UL: 300 V / 15 A / AWG 26 - AWG 12	
Qty.	42 pc(s).			
Type	BLZP 5.08HC/08/225 SN O ...	Version	Product data	Packaging
Order No.	1946310000	PCB plug-in connector, female plug, 5.08 mm, Number of poles: 8,	IEC: 400 V / 17.5 A / 0.2 - 4 mm ²	Box
GTIN (EAN)	4032248621880	225°, Clamping yoke connection, Clamping range, max. : 4 mm ² , Box	UL: 300 V / 15 A / AWG 26 - AWG 12	
Qty.	42 pc(s).			

**OMNIMATE Signal - series BL/SL 5.08
SL-SMT 5.08HC/08/90G 1.5SN BK BX**

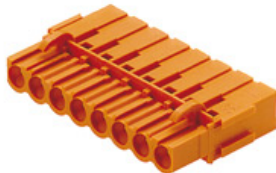
Weidmüller Interface GmbH & Co. KG
Klingenbergstraße 26
D-32758 Detmold
Germany
Fon: +49 5231 14-0
Fax: +49 5231 14-292083
www.weidmueller.com

Mating connector (fully pluggable)
BLC 5.08BR

Female plugs with crimp wire connection system. The female plugs provide space for labelling and can be coded.

General ordering data

Type	BLC 5.08/08/180BR OR BX	Version	Product data	Packaging
Order No.	1649430000	PCB plug-in connector, female plug, 5.08 mm, Number of poles: 8,	IEC: 400 V / 21 A	Box
GTIN (EAN)	4008190294540	180°, Crimp connection, Clamping range, max. : 2.5 mm ² , Box	UL: 300 V / 10 A / AWG 26 - AWG 14	
Qty.	50 pc(s).			
Type	BLC 5.08/08/180BR BK BX	Version	Product data	Packaging
Order No.	1712170000	PCB plug-in connector, female plug, 5.08 mm, Number of poles: 8,	IEC: 400 V / 21 A	Box
GTIN (EAN)	4008190935184	180°, Crimp connection, Clamping range, max. : 2.5 mm ² , Box	UL: 300 V / 10 A / AWG 26 - AWG 14	
Qty.	50 pc(s).			

BLF 5.08HC/180 SN

Just as reliable as the millionfold proven original and featuring innovative details:
The BLF 5.08HC PUSH IN version of the BLZP 5.08HC female connector is not only different in terms of connection system; it also has a more compact design. Weidmüller's innovative PUSH IN spring connection system stands for the future of easy and tool-free wire connection. HC = High Current.
In terms of versatility, the BLF 5.08HC offers just as much as the version which served as a model:

- 3 tested-and-proven wire outlet directions provide the usual flexibility for application-specific design
- 4 flange variations and the patented release latch allow the locking concept to be based on the requirements of the user
- Use the BLF 5.08HC and SL 5.08HC plug combination to reach the max. rated specifications

General ordering data

Type	BLF 5.08HC/08/180 SN BK ...	Version	Product data	Packaging
Order No.	1013490000	PCB plug-in connector, female plug, 5.08 mm, Number of poles: 8,	IEC: 400 V / 24 A / 0.2 - 2.5 mm ²	Box
GTIN (EAN)	4032248721641	180°, PUSH IN, Tension-clamp connection, Clamping range, max. :	UL: 300 V / 18.5 A / AWG 26 - AWG	
Qty.	42 pc(s).	3.31 mm ² , Box	12	
Type	BLF 5.08HC/08/180 SN OR ...	Version	Product data	Packaging
Order No.	1013750000	PCB plug-in connector, female plug, 5.08 mm, Number of poles: 8,	IEC: 400 V / 24 A / 0.2 - 2.5 mm ²	Box
GTIN (EAN)	4032248721863	180°, PUSH IN, Spring connection, Clamping range, max. : 3.31 mm ² ,	UL: 300 V / 18.5 A / AWG 26 - AWG	
Qty.	42 pc(s).	Box	12	

**OMNIMATE Signal - series BL/SL 5.08
SL-SMT 5.08HC/08/90G 1.5SN BK BX**

Weidmüller Interface GmbH & Co. KG
Klingenbergstraße 26
D-32758 Detmold
Germany
Fon: +49 5231 14-0
Fax: +49 5231 14-292083
www.weidmueller.com

Mating connector (fully pluggable)
BLZP 5.08HC/180 SN

Female plug with clamping-yoke screw system for connecting wires with straight (180°) outlet direction. The female connectors provide space for labelling and can be coded. Fastened by means of a flange or release latch. They also provide an integrated plus/minus screw, protection against faulty insertion of the wire, and they are delivered with open clamping yokes. HC = High Current.

General ordering data

Type	BLZP 5.08HC/08/180 SN B ...	Version	Product data	Packaging
Order No.	1943870000	PCB plug-in connector, female plug, 5.08 mm, Number of poles: 8,	IEC: 400 V / 23 A / 0.2 - 4 mm ²	Box
GTIN (EAN)	4032248617913	180°, Clamping yoke connection, Clamping range, max.: 4 mm ² , Box	UL: 300 V / 20 A / AWG 26 - AWG 12	
Qty.	42 pc(s).			
Type	BLZP 5.08HC/08/180 SN O ...	Version	Product data	Packaging
Order No.	1943640000	PCB plug-in connector, female plug, 5.08 mm, Number of poles: 8,	IEC: 400 V / 23 A / 0.2 - 4 mm ²	Box
GTIN (EAN)	4032248617647	180°, Clamping yoke connection, Clamping range, max.: 4 mm ² , Box	UL: 300 V / 20 A / AWG 26 - AWG 12	
Qty.	42 pc(s).			

BLL 5.08/90

Female header for PCB mounting. The solder pin length is optimised for wave flow soldering.

General ordering data

Type	BLL 5.08/08/90 3.2 SN B ...	Version	Product data	Packaging
Order No.	1730190000	PCB plug-in connector, female header, closed side, THT solder	IEC: 400 V / 23 A	Box
GTIN (EAN)	4050118007008	connection, 5.08 mm, Number of poles: 8, 90°, Solder pin length (l):	UL: 300 V / 15 A	
Qty.	42 pc(s).	3.2 mm, tinned, black, Box		
Type	BLL 5.08/08/90 3.2 SN O ...	Version	Product data	Packaging
Order No.	1623000000	PCB plug-in connector, female header, closed side, THT solder	IEC: 400 V / 23 A	Box
GTIN (EAN)	4008190194055	connection, 5.08 mm, Number of poles: 8, 90°, Solder pin length (l):	UL: 300 V / 15 A	
Qty.	42 pc(s).	3.2 mm, tinned, orange, Box		

**OMNIMATE Signal - series BL/SL 5.08
SL-SMT 5.08HC/08/90G 1.5SN BK BX**

Weidmüller Interface GmbH & Co. KG
Klingenbergstraße 26
D-32758 Detmold
Germany
Fon: +49 5231 14-0
Fax: +49 5231 14-292083
www.weidmueller.com

Mating connector (fully pluggable)
BLZ 5.00/180

Female plugs with clamping-yoke screw for wire connection with straight (180°) outlet direction. The female plugs provide space for labelling and can be coded.

General ordering data

Type	BLZ 5.00/08/180 SN DKG...	Version	Product data	Packaging
Order No.	1646880000	PCB plug-in connector, female plug, 5.00 mm, Number of poles: 8,	IEC: 400 V / 19 A / 0.5 - 2.5 mm ²	Box
GTIN (EAN)	4008190288136	180°, Clamping yoke connection, Clamping range, max. : 3.31 mm ² ,	UL: 300 V / 15 A / AWG 26 - AWG 12	
Qty.	50 pc(s).	Box		

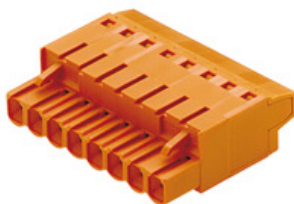
BLT 5.08HC

Female plugs with TOP screw connection system for connecting wires with straight 180° outlet direction. The female connectors provide space for labelling and can be coded. HC = High Current.

General ordering data

Type	BLT 5.08HC/08/180 SN GY ...	Version	Product data	Packaging
Order No.	1500100000	PCB plug-in connector, female plug, 5.08 mm, Number of poles: 8,	IEC: 400 V / 27 A / 0.2 - 2.5 mm ²	Box
GTIN (EAN)	4008190285210	180°, TOP connection, Clamping range, max. : 2.5 mm ² , Box	UL: 300 V / 17 A / AWG 26 - AWG 14	
Qty.	42 pc(s).			
Type	BLT 5.08HC/08/180 SN BL ...	Version	Product data	Packaging
Order No.	1500180000	PCB plug-in connector, female plug, 5.08 mm, Number of poles: 8,	IEC: 400 V / 27 A / 0.2 - 2.5 mm ²	Box
GTIN (EAN)	4008190368654	180°, TOP connection, Clamping range, max. : 2.5 mm ² , Box	UL: 300 V / 17 A / AWG 26 - AWG 14	
Qty.	42 pc(s).			

**OMNIMATE Signal - series BL/SL 5.08
SL-SMT 5.08HC/08/90G 1.5SN BK BX**

Weidmüller Interface GmbH & Co. KG
 Klingenbergstraße 26
 D-32758 Detmold
 Germany
 Fon: +49 5231 14-0
 Fax: +49 5231 14-292083
 www.weidmueller.com

Mating connector (fully pluggable)
BLZP 5.08HC/270 SN

Female plugs with clamping-yoke connection for connecting wires with a right-angle (90° or 270°) outlet direction. The female connectors provide space for labelling and can be coded. Fastened by means of a flange or release latch. They also provide an integrated plus/minus screw, protection against faulty insertion of the wire, and they are delivered with open clamping yokes. HC = High Current.

General ordering data

Type	BLZP 5.08HC/08/270 SN B ...	Version	Product data	Packaging
Order No.	1949080000	PCB plug-in connector, female plug, 5.08 mm, Number of poles: 8,	IEC: 400 V / 23 A / 0.2 - 4 mm ²	Box
GTIN (EAN)	4032248626533	270°, Clamping yoke connection, Clamping range, max. : 4 mm ² , Box	UL: 300 V / 20 A / AWG 26 - AWG 12	
Qty.	42 pc(s).			
Type	BLZP 5.08HC/08/270 SN O ...	Version	Product data	Packaging
Order No.	1948850000	PCB plug-in connector, female plug, 5.08 mm, Number of poles: 8,	IEC: 400 V / 23 A / 0.2 - 4 mm ²	Box
GTIN (EAN)	4032248626304	270°, Clamping yoke connection, Clamping range, max. : 4 mm ² , Box	UL: 300 V / 20 A / AWG 26 - AWG 12	
Qty.	42 pc(s).			

**OMNIMATE Signal - series BL/SL 5.08
SL-SMT 5.08HC/08/90G 1.5SN BK BX**

Weidmüller Interface GmbH & Co. KG
Klingenbergstraße 26
D-32758 Detmold
Germany
Fon: +49 5231 14-0
Fax: +49 5231 14-292083
www.weidmueller.com

Accessories
LED Light guides

Effective: the link between LED and front panel.

Floodlight indicators allow users to monitor the switching states without requiring a special design: optical plastic directs the light from standard LEDs around a bend into the connectors or through the front plate.

The fibre-optic elements are simply clipped behind the relevant 90° bend male connectors (90° outlet direction). Versions with different incoming light beam heights achieve maximum light efficiency for LEDs with different designs or heights.

The advantages compared to conventional solutions:

- No additional LED circuit board required behind the front panel
- No "long-legged" LEDs with separate mounting required
- Bent fibre-optic cable line for maximum light efficiency
- Uncomplicated front plate bore holes due to circular shape of outgoing light beam
- Easy to maintain correct clearance and creepage distance
- Can be partitioned for smaller pole numbers

The result: simplified manufacturing process, reduced costs and simplified design

General ordering data

Type	SL FLA 3.8/1	Version	Product data	Packaging
Order No.	1580110000	PCB plug-in connector, Accessories, Flood-light display, Transparent,		Box
GTIN (EAN)	4008190050740	Number of poles: 1		
Qty.	100 pc(s).			
Type	SL FLA 2,3/1	Version	Product data	Packaging
Order No.	1636670000	PCB plug-in connector, Accessories, Flood-light display, Transparent,		Box
GTIN (EAN)	4008190409975	Number of poles: 1		
Qty.	100 pc(s).			
Type	SL FLA 2,3/24	Version	Product data	Packaging
Order No.	1636680000	PCB plug-in connector, Accessories, Flood-light display, Transparent,		Box
GTIN (EAN)	4008190409968	Number of poles: 1		
Qty.	10 pc(s).			
Type	SL FLA 3.8/24	Version	Product data	
Order No.	1595860000	PCB plug-in connector, Accessories, Flood-light display, Transparent,		
GTIN (EAN)	4008190140892	Number of poles: 1		
Qty.	10 pc(s).			
Type	SL FLA 9.0/24	Version	Product data	
Order No.	1595870000	PCB plug-in connector, Accessories, Flood-light display, Transparent,		
GTIN (EAN)	4008190079796	Number of poles: 1		
Qty.	10 pc(s).			
Type	SL FLA 9.0/1	Version	Product data	Packaging
Order No.	1580120000	PCB plug-in connector, Accessories, Flood-light display, Transparent,		Box
GTIN (EAN)	4008190031909	Number of poles: 1		
Qty.	100 pc(s).			

OMNIMATE Signal - series BL/SL 5.08 SL-SMT 5.08HC/08/90G 1.5SN BK BX

Weidmüller Interface GmbH & Co. KG
 Klingenbergstraße 26
 D-32758 Detmold
 Germany
 Fon: +49 5231 14-0
 Fax: +49 5231 14-292083
 www.weidmueller.com

Accessories

Type	SL FLA 1.5/1	Version	Product data	Packaging
Order No.	1580100000	PCB plug-in connector, Accessories, Flood-light display, Transparent,		Box
GTIN (EAN)	4008190152475	Number of poles: 1		
Qty.	100 pc(s).			
Type	SL FLA 1.5/24	Version	Product data	
Order No.	1595850000	PCB plug-in connector, Accessories, Flood-light display, Transparent,		
GTIN (EAN)	4008190092573	Number of poles: 1		
Qty.	10 pc(s).			

Coding elements



Only connects what is supposed to be connected: the right connection at the right place.

Coding elements and locking devices clearly assign connecting elements during the manufacturing process and operation

The coding elements and locking devices are inserted prior to assembly or during the cable assembly phase. The Weidmüller alternative: configure online using the variant configurator to precode prior to delivery.

Incorrect assembly on the circuit board and incorrect plugging of connecting elements is no longer possible. The advantage: no troubleshooting during manufacture and no operational errors by the user.

General ordering data

Type	BLZ/SL KO OR BX	Version	Product data	Packaging
Order No.	1573010000	PCB plug-in connector, Accessories, Coding element, orange, Number		Box
GTIN (EAN)	4008190048396	of poles: 1		
Qty.	100 pc(s).			
Type	BLZ/SL KO BK BX	Version	Product data	Packaging
Order No.	1545710000	PCB plug-in connector, Accessories, Coding element, black, Number		Box
GTIN (EAN)	4008190087142	of poles: 1		
Qty.	50 pc(s).			

OMNIMATE Signal - series BL/SL 5.08 SL-SMT 5.08HC/08/90G 1.5SN BK BX

Weidmüller Interface GmbH & Co. KG
 Klingenbergstraße 26
 D-32758 Detmold
 Germany
 Fon: +49 5231 14-0
 Fax: +49 5231 14-292083
 www.weidmueller.com

Accessories

Additional accessories



No task is too small when creating the perfect solution.

Connections form just one part of the overall process. Small details are often the key to the perfect solution in applications where potentials are tested, grouped or even isolated.

A system is not a system without small but useful details:

- Test plugs - ensure reliable pick-up from diagnostic sockets
- Cross-connectors - ensure a stable electrical distribution contact directly at the connection
- Compartment partition elements - divide a large number of male connectors into several separate socket connector channels
- Locks and clips - optional vibration-resistant clip-on connection or mounting for male and female connectors

In tandem with the manufacturing process and application - more accessories = smaller workload

General ordering data

Type	SL AT SW	Version	Product data	Packaging
Order No.	1770240000	PCB plug-in connector, Accessories, Spacer, black, Number of poles: 1		Box
GTIN (EAN)	4032248117710			
Qty.	100 pc(s).			
Type	SL AT OR	Version	Product data	Packaging
Order No.	1598300000	PCB plug-in connector, Accessories, Spacer, orange, Number of poles: 1		Box
GTIN (EAN)	4008190189266			
Qty.	100 pc(s).			

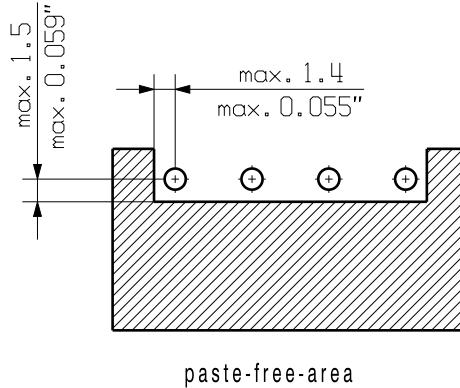
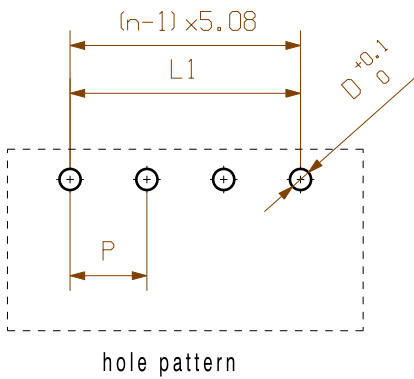
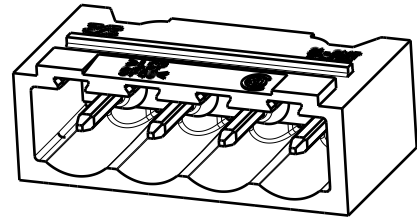
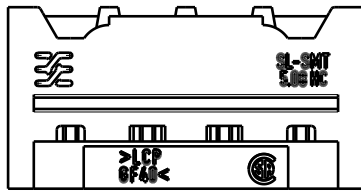
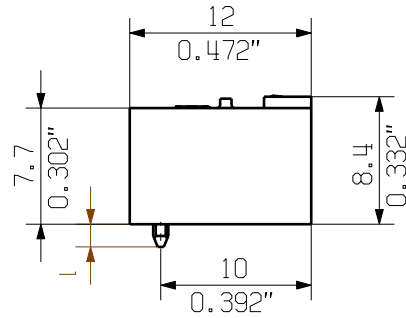
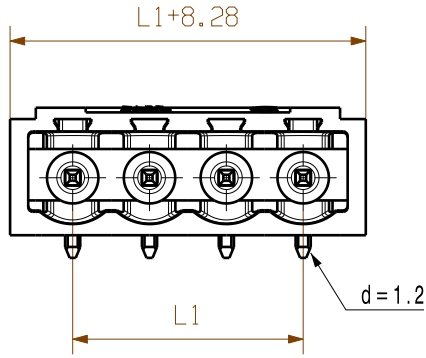

hole pattern

paste-free-area

D = 1.4/0.055" or 1.5/0.059" (REFLOW SOLDERING)
 RECOMMENDATION FOR AUTOMATIC ASSEMBLY
 (1.4mm FOR n=2...8 / 1.5mm for n=9...24)

n = Polzahl / no of poles
 P = Raster / pitch

For the mounting of PCBs, it should be noted that the rated data relates only to the PCB components alone.

The necessary creepage and clearance paths must be observed in connection with the respective applicant in accordance to IEC 664 / VDE 0110.

The current-carrying capacity and pitch tolerance is to be determined according to DIN IEC 326 part 3 very fine.

Weidmüller PCB components are tested to the DIN EN 61984 standard, and are valid for its field of application.

Provided that the components are used to the intended purpose, all requirements with respect to the occurring of electrical, mechanical, thermic and corrosive stress will be satisfied.

shown: SL-SMT 5.08HC/04/90G

24	116.84	4.600	+/- 0.2
23	111.76	4.400	
22	106.68	4.200	
21	101.60	4.000	
20	96.52	3.800	
19	91.44	3.600	+/- 0.15
18	86.36	3.400	
17	81.28	3.200	
16	76.20	3.000	
15	71.12	2.800	
14	66.04	2.600	+/- 0.1
13	60.96	2.400	
12	55.88	2.200	
11	50.80	2.000	
10	45.72	1.800	
9	40.64	1.600	+/- 0.1
8	35.56	1.400	
7	30.48	1.200	
6	25.40	1.000	
5	20.32	0.800	
4	15.24	0.600	+/- 0.1
3	10.16	0.400	
2	5.08	0.200	
1	tolerance		

4.5	0.1/-0.3
3.2	0.1/-0.3
2.1	0.1/-0.3
1.5	-0.3
1	tolerance

	DIN ISO 2768-m	106339/4 30.07.18 HERTEL_S 00	Weidmüller	Cat.no.: . . .		2 33262
	Modification			Drawing no. 31	Sheet 02 of 04 sheets	
	Date	Name	SL-SMT 5.08HC/.../90... STIFTLISTE MALE HEADER			
	Drawn	29.11.2007				
Scale: 2:1	Responsible		HERTEL_S	Product file: SL-SMT 5.08		
	Checked	01.08.2018	KOCH_JG			
Supersedes: .	Approved		LANG_T	7280		

The reproduction, distribution and utilization of this document as well as the communication of its contents without explicit authorization is prohibited. Offenders will be held liable for the payment of damages. Weidmüller exclusively reserves the right to file for patents, utility models or designs.

© Weidmüller Interface GmbH & Co. KG

Recommended wave soldering profiles

Weidmüller Interface GmbH & Co. KG
 Klängenbergstraße 16
 D-32758 Detmold
 Germany
 Fon: +49 5231 14-0
 Fax: +49 5231 14-292083
 www.weidmueller.com

Single Wave:



Double Wave:



Wave soldering profiles

Wired connection elements should be processed in accordance with the DIN EN 61760-1 standard. We have included two recommendations for practical wave soldering profiles, with which Weidmüller PCB terminals and connectors are qualified.

When choosing a suitable profile for your application, the following factors also need to be considered:

- PCB thickness
- Proportion of Cu in the layers
- Single/double-sided assembly
- Product range
- Heating and cooling rates

The single and double wave profiles each indicate the recommended operating range, including the maximum soldering temperature of 260°C. In practice, the maximum soldering temperature is quite often well below the above maximum profile.

Recommended reflow soldering profile

Weidmüller Interface GmbH & Co. KG
 Klingenbergstraße 16
 D-32758 Detmold
 Germany
 Fon: +49 5231 14-0
 Fax: +49 5231 14-292083
 www.weidmueller.com



Reflow soldering profile

The perfect soldering profile for SMT Surface Mount Technology is one the most exiting question in SMT production. But there are more than one correct answer: The diagram of temperature-on-time is related to processing features of solder paste and to maximum load of components.

We have to consider the following parameters:

- Time for pre heating
- Maximum temperature
- Time above melting point
- Time for cooling
- Maximum heating rate
- Maximum cooling rate

We recommend a typical solder profile with associated process limits. With preheating components and board are prepared smoothly for the solder phase. Heating rate is typically $\leq +3\text{K/s}$. In parallel the solder paste is ‚activated‘. The time above melting point of 217°C the paste gets liquid and components and boards begin to connect. The maximum temperature of 245°C to 254°C should stay between 10 and 40 seconds. In the cooling phase at $\geq -6\text{K/s}$ solder is cured. Board and components cool down while avoiding cold cracks.