

**OMNIMATE Signal - series BL/SL 5.08  
SL-SMT 5.08HC/04/90G 1.5SN BK RL**

**Weidmüller Interface GmbH & Co. KG**  
Klingenbergstraße 26  
D-32758 Detmold  
Germany  
Fon: +49 5231 14-0  
Fax: +49 5231 14-292083  
www.weidmueller.com



Similar to illustration

High-temperature-resistant pin header, packed in box or tape. On tape, with 1.5 mm solder pin, optimised for automatic assembly. 3.2 mm solder pin suitable for reflow and wave soldering. The pin headers provide space for labelling and can be coded. HC = High Current.

**General ordering data**

Type	SL-SMT 5.08HC/04/90G 1.5SN BK RL
Order No.	<a href="#">1775024001</a>
Version	PCB plug-in connector, male header, closed side, THT/THR solder connection, 5.08 mm, Number of poles: 4, 90°, Solder pin length (l): 1.5 mm, tinned, black, Tape
GTIN (EAN)	4032248167746
Qty.	350 pc(s).
Product data	IEC: 400 V / 27.5 A UL: 300 V / 18.5 A
Packaging	Tape

Creation date May 3, 2020 12:32:39 PM CEST

**OMNIMATE Signal - series BL/SL 5.08  
SL-SMT 5.08HC/04/90G 1.5SN BK RL**

**Weidmüller Interface GmbH & Co. KG**  
 Klingenbergstraße 26  
 D-32758 Detmold  
 Germany  
 Fon: +49 5231 14-0  
 Fax: +49 5231 14-292083  
 www.weidmueller.com

**Technical data****Dimensions and weights**

Width	23.52 mm	Width (inches)	0.926 inch
Height	9.9 mm	Height (inches)	0.39 inch
Height of lowest version	8.4 mm	Depth	12 mm
Depth (inches)	0.472 inch	Net weight	3.151 g

**System specifications**

Product family	OMNIMATE Signal - series BL/SL 5.08	Type of connection	Board connection
Mounting onto the PCB	THT/THR solder connection	Pitch in mm (P)	5.08 mm
Pitch in inches (P)	0.2 inch	Outgoing elbow	90°
Number of poles	4	Number of solder pins per pole	1
Solder pin length (l)	1.5 mm	Solder pin length tolerance	0 / -0.3 mm
Tolerance of solder pin position	± 0.1 mm	Solder pin dimensions	d = 1.2 mm, Octagonal
Solder eyelet hole diameter (D)	1.4 mm	Solder eyelet hole diameter tolerance (D)	+ 0,1 mm
L1 in mm	15.24 mm	L1 in inches	0.6 inch
Number of rows	1	Pin series quantity	1
Volume resistance	≤ 5mΩ	Can be coded	Yes
Plugging cycles	25	Plugging force/pole, max.	9 N
Pulling force/pole, max.	7 N		

**Material data**

Insulating material	LCP GF	Colour	black
Colour chart (similar)	RAL 9011	Insulating material group	IIIa
Comparative Tracking Index (CTI)	≥ 175	Insulation strength	≥ 10 <sup>8</sup> Ω
Moisture Level (MSL)	1	UL 94 flammability rating	V-0
GWIT	930 °C	GWFI	960 °C
Contact material	CuMg	Contact surface	tinned
Layer structure of solder connection	1-3 μm Ni / 2-4 μm Sn matt	Layer structure of plug contact	1-3 μm Ni / 2-4 μm Sn matt
Storage temperature, min.	-25 °C	Storage temperature, max.	50 °C
Max. relative humidity during storage	70 %	Operating temperature, min.	-50 °C
Operating temperature, max.	100 °C	Temperature range, installation, min.	-30 °C
Temperature range, installation, max.	100 °C		

**Rated data acc. to IEC**

tested acc. to standard	IEC 60664-1, IEC 61984	Rated current, min. number of poles (Tu=20°C)	27.5 A
Rated current, max. number of poles (Tu=20°C)	19 A	Rated current, min. number of poles (Tu=40°C)	24 A
Rated current, max. number of poles (Tu=40°C)	16.5 A	Rated voltage for surge voltage class / pollution degree II/2	400 V
Rated voltage for surge voltage class / pollution degree III/2	320 V	Rated voltage for surge voltage class / pollution degree III/3	250 V
Rated impulse voltage for surge voltage class/ pollution degree II/2	4 kV	Rated impulse voltage for surge voltage class/ pollution degree III/2	4 kV
Rated impulse voltage for surge voltage class/ contamination degree III/3	4 kV		

**OMNIMATE Signal - series BL/SL 5.08  
SL-SMT 5.08HC/04/90G 1.5SN BK RL**

**Weidmüller Interface GmbH & Co. KG**  
 Klingenbergstraße 26  
 D-32758 Detmold  
 Germany  
 Fon: +49 5231 14-0  
 Fax: +49 5231 14-292083  
 www.weidmueller.com

**Technical data****Rated data acc. to CSA**

Institute (CSA)



Certificate No. (CSA)

200039-1176845

Rated voltage (Use group B / CSA)	300 V
Rated current (Use group B / CSA)	18.5 A
Reference to approval values	Specifications are maximum values, details - see approval certificate.

Rated voltage (Use group D / CSA)	300 V
Rated current (Use group D / CSA)	18.5 A

**Rated data acc. to UL 1059**

Institute (UR)



Certificate No. (UR)

E60693

Rated voltage (Use group B / UL 1059)	300 V
Rated current (Use group B / UL 1059)	18.5 A
Reference to approval values	Specifications are maximum values, details - see approval certificate.

Rated voltage (Use group D / UL 1059)	300 V
Rated current (Use group D / UL 1059)	10 A

**Packing**

Packaging	Tape	VPE length	90 mm
VPE width	360 mm	VPE height	365 mm
Tape depth (T2)	12.8 mm	Tape width (W)	44 mm
Tape pocket depth (K0)	12.3 mm	Tape pocket height (A0)	12.3 mm
Tape pocket width (B0)	23.82 mm	Tape pocket separation (P1)	16 mm
Tape hole separation (E)	1.75 mm	Tape pocket separation (F)	20.2 mm
Tape reel diameter $\varnothing$ (A)	330 mm	Surface resistance	$R_s = 10^9 - 10^{12} \Omega$

**Classifications**

ETIM 6.0	EC002637	ETIM 7.0	EC002637
eClass 9.0	27-44-04-02	eClass 9.1	27-44-04-02
eClass 10.0	27-44-04-02	UNSPSC	30-21-18-10

**Notes**

Notes

- Gold-plated contact surfaces on request
- Rated current related to rated cross-section & min. No. of poles.
- Diameter of solder eyelet  $D = 1.4 + 0.1 \text{ mm}$
- Solder eyelet diameter  $D = 1.5 + 0.1 \text{ mm}$ , from 9 poles
- P on drawing = pitch
- Rated data refer only to the component itself. Clearance and creepage distances to other components are to be designed in accordance with the relevant application standards.

IPC conformity

Conformity: The products are developed, manufactured and delivered according international recognized standards and norms and comply with the assured properties in the data sheet resp. fulfill decorative properties in accordance with IPC-A-610 "Class 2". Further claims on the products can be evaluated on request.

Creation date May 3, 2020 12:32:39 PM CEST

**Data sheet**

**OMNIMATE Signal - series BL/SL 5.08  
SL-SMT 5.08HC/04/90G 1.5SN BK RL**

**Weidmüller Interface GmbH & Co. KG**  
Klingenbergstraße 26  
D-32758 Detmold  
Germany  
Fon: +49 5231 14-0  
Fax: +49 5231 14-292083  
www.weidmueller.com

**Technical data**

**Approvals**

Approvals



ROHS

Conform

**Downloads**

Approval/Certificate/Document of  
Conformity

[Declaration of the Manufacturer](#)

Brochure/Catalogue

- [FL DRIVES EN](#)
- [MB SMT EN](#)
- [FL DRIVES DE](#)
- [MB DEVICE MANUF. EN](#)
- [CAT 2 PORTFOLIOGUIDE EN](#)
- [FL BUILDING SAFETY EN](#)
- [FL APPL LED LIGHTING EN](#)
- [FLIndustr.CONTROLS EN](#)
- [FL MACHINE SAFETY EN](#)
- [FL HEATING ELECTR EN](#)
- [FL APPL\\_INVERTER EN](#)
- [FL\\_BASE\\_STATION\\_EN](#)
- [FL ELEVATOR EN](#)
- [FL POWER SUPPLY EN](#)
- [FL 72H SAMPLE SER EN](#)
- [PO OMNIMATE EN](#)

Engineering Data

[EPLAN, WSCAD](#)

Engineering Data

[STEP](#)

White paper surface mount technology

[Download Whitepaper](#)

**OMNIMATE Signal - series BL/SL 5.08  
SL-SMT 5.08HC/04/90G 1.5SN BK RL**

**Weidmüller Interface GmbH & Co. KG**  
Klingenbergstraße 26  
D-32758 Detmold  
Germany  
Fon: +49 5231 14-0  
Fax: +49 5231 14-292083  
www.weidmueller.com

**Drawings**

**Dimensional drawing**

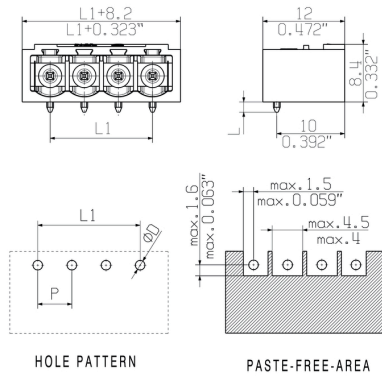

**Example of use**



Safe power transmission

**Dimensional drawing**

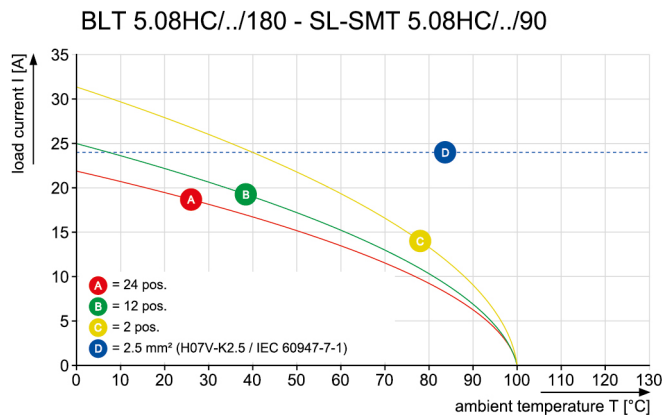

**Packaging drawing**

Proven properties



**OMNIMATE Signal - series BL/SL 5.08  
SL-SMT 5.08HC/04/90G 1.5SN BK RL**

**Weidmüller Interface GmbH & Co. KG**  
Klingenbergstraße 26  
D-32758 Detmold  
Germany  
Fon: +49 5231 14-0  
Fax: +49 5231 14-292083  
www.weidmueller.com

**Mating connector (conditionally pluggable)**

**BLT 5.08HC/180B**

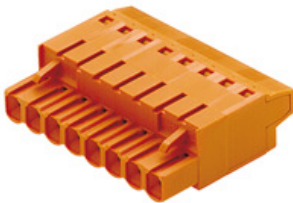

Female plugs with TOP screw connection system for connecting wires with straight 180° outlet direction. The female connectors provide space for labelling and can be coded. HC = High Current.

**General ordering data**

Type	BLT 5.08HC/04/180B SN O ...	Version	Product data	Packaging
Order No.	<a href="#">1502060000</a>	PCB plug-in connector, female plug, 5.08 mm, Number of poles: 4,	IEC: 400 V / 27 A / 0.2 - 2.5 mm <sup>2</sup>	Box
GTIN (EAN)	4008190166441	180°, TOP connection, Clamping range, max. : 2.5 mm <sup>2</sup> , Box	UL: 300 V / 17 A / AWG 26 - AWG 14	
Qty.	78 pc(s).			

**OMNIMATE Signal - series BL/SL 5.08  
SL-SMT 5.08HC/04/90G 1.5SN BK RL**

**Weidmüller Interface GmbH & Co. KG**  
 Klingenbergstraße 26  
 D-32758 Detmold  
 Germany  
 Fon: +49 5231 14-0  
 Fax: +49 5231 14-292083  
 www.weidmueller.com

**Mating connector (fully pluggable)**
**BLDF 5.08/180 SN**

The powerful daisy-chain solution for high-performance signal bus applications is also suitable for 400V auxiliary power chains with 18.5A current-carrying capacity. The large clamping capacity (up to 2.5mm<sup>2</sup> wire cross-sections) is particularly beneficial for long bus cables or high currents because of the low voltage drop. Four flange variations, including the patented release latch, allow for user-friendly unplugging designs.

**General ordering data**

Type	BLDF 5.08/04/180 SN OR ...	Version	Product data	Packaging
Order No.	<a href="#">1001170000</a>	PCB plug-in connector, female plug, 5.08 mm, Number of poles: 4,	IEC: 400 V / 20.8 A / 0.2 - 2.5 mm <sup>2</sup>	Box
GTIN (EAN)	4032248818075	180°, PUSH IN, Spring connection, Clamping range, max. : 3.31 mm <sup>2</sup> ,	UL: 300 V / 18.5 A / AWG 12 - AWG	
Qty.	60 pc(s).	Box	26	
Type	BLDF 5.08/04/180 SN BK ...	Version	Product data	Packaging
Order No.	<a href="#">1000880000</a>	PCB plug-in connector, female plug, 5.08 mm, Number of poles: 4,	IEC: 400 V / 20.8 A / 0.2 - 2.5 mm <sup>2</sup>	Box
GTIN (EAN)	4032248817269	180°, PUSH IN, Spring connection, Clamping range, max. : 3.31 mm <sup>2</sup> ,	UL: 300 V / 18.5 A / AWG 12 - AWG	
Qty.	60 pc(s).	Box	26	

**BLZ 5.08/90**



Female plugs with clamping-yoke screw connection. The female plugs provide space for labelling and can be coded.

**General ordering data**

Type	BLZ 5.08/04/90 SN GY BX	Version	Product data	Packaging
Order No.	<a href="#">1552900000</a>	PCB plug-in connector, female plug, 5.08 mm, Number of poles: 4,	IEC: 400 V / 15 A / 0.2 - 2.5 mm <sup>2</sup>	Box
GTIN (EAN)	4008190401566	90°, Clamping yoke connection, Clamping range, max. : 3.31 mm <sup>2</sup> ,	UL: 300 V / 10 A / AWG 26 - AWG 12	
Qty.	90 pc(s).	Box		

**OMNIMATE Signal - series BL/SL 5.08  
SL-SMT 5.08HC/04/90G 1.5SN BK RL**

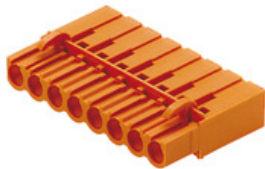
**Weidmüller Interface GmbH & Co. KG**  
Klingenbergstraße 26  
D-32758 Detmold  
Germany  
Fon: +49 5231 14-0  
Fax: +49 5231 14-292083  
www.weidmueller.com

**Mating connector (fully pluggable)**
**BLC 5.08R**

Female plugs with crimp wire connection system. The female plugs provide space for labelling and can be coded.

**General ordering data**

Type	Version	Product data	Packaging
BLC 5.08/04/180R BK BX	PCB plug-in connector, female plug, 5.08 mm, Number of poles: 4, 180°, Crimp connection, Clamping range, max. : 2.5 mm², Box	IEC: 400 V / 21 A UL: 300 V / 10 A / AWG 26 - AWG 14	Box
Order No. <a href="#">1711980000</a>			
GTIN (EAN) 4008190934996			
Qty. 100 pc(s).			
BLC 5.08/04/180R OR BX	PCB plug-in connector, female plug, 5.08 mm, Number of poles: 4, 180°, Crimp connection, Clamping range, max. : 2.5 mm², Box	IEC: 400 V / 21 A UL: 300 V / 10 A / AWG 26 - AWG 14	Box
Order No. <a href="#">1610510000</a>			
GTIN (EAN) 4008190065102			
Qty. 100 pc(s).			

**BLL 5.08/180**

Female header for PCB mounting. The solder pin length is optimised for wave flow soldering.

**General ordering data**

Type	Version	Product data	Packaging
BLL 5.08/04/180 4.5SN B ...	PCB plug-in connector, female header, closed side, THT solder connection, 5.08 mm, Number of poles: 4, 180°, Solder pin length (l): 4.5 mm, tinned, black, Box	IEC: 400 V / 23 A UL: 300 V / 15 A	Box
Order No. <a href="#">1646270000</a>			
GTIN (EAN) 4008190285616			
Qty. 100 pc(s).			
BLL 5.08/04/180 3.2 SN ...	PCB plug-in connector, female header, closed side, THT solder connection, 5.08 mm, Number of poles: 4, 180°, Solder pin length (l): 3.2 mm, tinned, Pebble grey, Box	IEC: 400 V / 23 A UL: 300 V / 15 A	Box
Order No. <a href="#">1687580000</a>			
GTIN (EAN) 4008190853662			
Qty. 90 pc(s).			
BLL 5.08/04/180 4.5 SN ...	PCB plug-in connector, female header, closed side, THT solder connection, 5.08 mm, Number of poles: 4, 180°, Solder pin length (l): 4.5 mm, tinned, orange, Box	IEC: 400 V / 23 A UL: 300 V / 15 A	Box
Order No. <a href="#">1646160000</a>			
GTIN (EAN) 4008190285500			
Qty. 90 pc(s).			
BLL 5.08/04/180 3.2 SN ...	PCB plug-in connector, female header, closed side, THT solder connection, 5.08 mm, Number of poles: 4, 180°, Solder pin length (l): 3.2 mm, tinned, orange, Box	IEC: 400 V / 23 A UL: 300 V / 15 A	Box
Order No. <a href="#">1630730000</a>			
GTIN (EAN) 4008190204150			
Qty. 90 pc(s).			



**OMNIMATE Signal - series BL/SL 5.08  
SL-SMT 5.08HC/04/90G 1.5SN BK RL**

**Weidmüller Interface GmbH & Co. KG**  
Klingenbergstraße 26  
D-32758 Detmold  
Germany  
Fon: +49 5231 14-0  
Fax: +49 5231 14-292083  
www.weidmueller.com

**Mating connector (fully pluggable)**
**BLZ 5.08/180**

Female plugs with clamping-yoke screw for wire connection with straight (180°) outlet direction. The female plugs provide space for labelling and can be coded.

**General ordering data**

Type	BLZ 5.08/04/180 SN DKGN ...	Version	Product data	Packaging
Order No.	<a href="#">1526650000</a>	PCB plug-in connector, female plug, 5.08 mm, Number of poles: 4,	IEC: 400 V / 19 A / 0.2 - 2.5 mm <sup>2</sup>	Box
GTIN (EAN)	4008190069056	180°, Clamping yoke connection, Clamping range, max. : 3.31 mm <sup>2</sup> ,	UL: 300 V / 15 A / AWG 26 - AWG 12	
Qty.	100 pc(s).	Box		
Type	BLZ 5.08/04/180 SN OR B ...	Version	Product data	Packaging
Order No.	<a href="#">1594260000</a>	PCB plug-in connector, female plug, 5.08 mm, Number of poles: 4,	IEC: 400 V / 19 A / 0.2 - 2.5 mm <sup>2</sup>	Box
GTIN (EAN)	4008190001537	180°, Clamping yoke connection, Clamping range, max. : 3.31 mm <sup>2</sup> ,	UL: 300 V / 15 A / AWG 26 - AWG 12	
Qty.	90 pc(s).	Box		
Type	BLZ 5.08/04/180 SN GY BX	Version	Product data	Packaging
Order No.	<a href="#">1526600000</a>	PCB plug-in connector, female plug, 5.08 mm, Number of poles: 4,	IEC: 400 V / 19 A / 0.2 - 2.5 mm <sup>2</sup>	Box
GTIN (EAN)	4008190287115	180°, Clamping yoke connection, Clamping range, max. : 3.31 mm <sup>2</sup> ,	UL: 300 V / 15 A / AWG 26 - AWG 12	
Qty.	100 pc(s).	Box		

**BLF 5.08HC/270 SN**

Just as reliable as the millionfold proven original and featuring innovative details:  
The BLF 5.08HC PUSH IN version of the BLZP 5.08HC female connector is not only different in terms of connection system; it also has a more compact design. Weidmüller's innovative PUSH IN spring connection system stands for the future of easy and tool-free wire connection. HC = High Current.  
In terms of versatility, the BLF 5.08HC offers just as much as the version which served as a model:

- 3 tested-and-proven wire outlet directions provide the usual flexibility for application-specific design
- 4 flange variations and the patented release latch allow the locking concept to be based on the requirements of the user
- Use the BLF 5.08HC and SL 5.08HC plug combination to reach the max. rated specifications

**General ordering data**

Type	BLF 5.08HC/04/270 SN BK ...	Version	Product data	Packaging
Order No.	<a href="#">1981950000</a>	PCB plug-in connector, female plug, 5.08 mm, Number of poles: 4,	IEC: 400 V / 24 A / 0.2 - 2.5 mm <sup>2</sup>	Box
GTIN (EAN)	4032248684649	270°, PUSH IN, Spring connection, Clamping range, max. : 3.31 mm <sup>2</sup> ,	UL: 300 V / 18.5 A / AWG 26 - AWG 12	
Qty.	90 pc(s).	Box		

**OMNIMATE Signal - series BL/SL 5.08  
SL-SMT 5.08HC/04/90G 1.5SN BK RL**

**Weidmüller Interface GmbH & Co. KG**  
Klingenbergstraße 26  
D-32758 Detmold  
Germany  
Fon: +49 5231 14-0  
Fax: +49 5231 14-292083  
www.weidmueller.com

**Mating connector (fully pluggable)**

Type	BLF 5.08HC/04/270 SN OR ...	Version	Product data	Packaging
Order No.	<a href="#">1982720000</a>	PCB plug-in connector, female plug, 5.08 mm, Number of poles: 4,	IEC: 400 V / 24 A / 0.2 - 2.5 mm <sup>2</sup>	Box
GTIN (EAN)	4032248686810	270°, PUSH IN, Spring connection, Clamping range, max. : 3.31 mm <sup>2</sup> ,	UL: 300 V / 18.5 A / AWG 26 - AWG	
Qty.	90 pc(s).	Box	12	

**BLL 5.08/180B**

Female header for PCB mounting. The solder pin length is optimised for wave flow soldering.

**General ordering data**

Type	BLL 5.08/04/180B 3.2SN ...	Version	Product data	Packaging
Order No.	<a href="#">1682750000</a>	PCB plug-in connector, female header, Dovetails for fixing blocks, THT	IEC: 400 V / 23 A	Box
GTIN (EAN)	4008190474515	solder connection, 5.08 mm, Number of poles: 4, 180°, Solder pin	UL: 300 V / 15 A	
Qty.	78 pc(s).	length (l): 3.2 mm, tinned, orange, Box		

**BLZF 5.08/180**

Female plugs with tension-clamp wire connection system, straight 180° outlet direction. The female plugs provide space for labelling and can be coded.

**General ordering data**

Type	BLZF 5.08/04/180 SN DKG ...	Version	Product data	Packaging
Order No.	<a href="#">1707940000</a>	PCB plug-in connector, female plug, 5.08 mm, Number of poles: 4,	IEC: 400 V / 17 A / 0.2 - 2.5 mm <sup>2</sup>	Box
GTIN (EAN)	4008190317355	180°, Tension-clamp connection, Clamping range, max. : 3.31 mm <sup>2</sup> ,	UL: 300 V / 15 A / AWG 26 - AWG 12	
Qty.	90 pc(s).	Box		

**OMNIMATE Signal - series BL/SL 5.08  
SL-SMT 5.08HC/04/90G 1.5SN BK RL**

**Weidmüller Interface GmbH & Co. KG**  
Klingenbergstraße 26  
D-32758 Detmold  
Germany  
Fon: +49 5231 14-0  
Fax: +49 5231 14-292083  
www.weidmueller.com

**Mating connector (fully pluggable)**
**BLZP 5.08HC/225B SN**

Clamping-yoke connection with right-angled (90° or 270°) or angled (225°) outlet direction. The female connectors provide space for labelling and can be coded. Fastened by means of a flange or release latch. They also provide an integrated plus/minus screw, protection against faulty insertion of the wire, and they are delivered with open clamping yokes. HC = High Current.

**General ordering data**

Type	BLZP 5.08HC/04/225B SN ...	Version	Product data	Packaging
Order No.	<a href="#">1945770000</a>	PCB plug-in connector, female plug, 5.08 mm, Number of poles: 4,	IEC: 400 V / 17.5 A / 0.2 - 4 mm <sup>2</sup>	Box
GTIN (EAN)	4032248621248	225°, Clamping yoke connection, Clamping range, max. : 4 mm <sup>2</sup> , Box	UL: 300 V / 15 A / AWG 26 - AWG 12	
Qty.	78 pc(s).			
Type	BLZP 5.08HC/04/225B SN ...	Version	Product data	Packaging
Order No.	<a href="#">1946000000</a>	PCB plug-in connector, female plug, 5.08 mm, Number of poles: 4,	IEC: 400 V / 17.5 A / 0.2 - 4 mm <sup>2</sup>	Box
GTIN (EAN)	4032248621521	225°, Clamping yoke connection, Clamping range, max. : 4 mm <sup>2</sup> , Box	UL: 300 V / 15 A / AWG 26 - AWG 12	
Qty.	78 pc(s).			

**BLZP 5.08HC/90 SN**

Female plugs with clamping-yoke connection for connecting wires with a right-angle (90° or 270°) outlet direction. The female connectors provide space for labelling and can be coded. Fastened by means of a flange or release latch. They also provide an integrated plus/minus screw, protection against faulty insertion of the wire, and they are delivered with open clamping yokes. HC = High Current.

**General ordering data**

Type	BLZP 5.08HC/04/90 SN OR ...	Version	Product data	Packaging
Order No.	<a href="#">1948020000</a>	PCB plug-in connector, female plug, 5.08 mm, Number of poles: 4,	IEC: 400 V / 23 A / 0.2 - 4 mm <sup>2</sup>	Box
GTIN (EAN)	4032248624249	90°, Clamping yoke connection, Clamping range, max. : 4 mm <sup>2</sup> , Box	UL: 300 V / 20 A / AWG 26 - AWG 12	
Qty.	90 pc(s).			
Type	BLZP 5.08HC/04/90 SN BK ...	Version	Product data	Packaging
Order No.	<a href="#">1948260000</a>	PCB plug-in connector, female plug, 5.08 mm, Number of poles: 4,	IEC: 400 V / 23 A / 0.2 - 4 mm <sup>2</sup>	Box
GTIN (EAN)	4032248624782	90°, Clamping yoke connection, Clamping range, max. : 4 mm <sup>2</sup> , Box	UL: 300 V / 20 A / AWG 26 - AWG 12	
Qty.	90 pc(s).			

**OMNIMATE Signal - series BL/SL 5.08  
SL-SMT 5.08HC/04/90G 1.5SN BK RL**

**Weidmüller Interface GmbH & Co. KG**  
Klingenbergstraße 26  
D-32758 Detmold  
Germany  
Fon: +49 5231 14-0  
Fax: +49 5231 14-292083  
www.weidmueller.com

**Mating connector (fully pluggable)**
**BLDT 5.08B**

Female plugs with two clamping-yoke screw connections per pole for wire connections with 90° and 270° outlet directions. The female plugs provide space for labelling and can be coded.

**General ordering data**

Type	BLDT 5.08/04/-B SN OR BX	Version	Product data	Packaging
Order No.	<a href="#">1651760000</a>	PCB plug-in connector, female plug, 5.08 mm, Number of poles: 4,	IEC: 400 V / 14 A / 0.2 - 2.5 mm <sup>2</sup>	Box
GTIN (EAN)	4008190400446	180°, Clamping yoke connection, Clamping range, max. : 3.31 mm <sup>2</sup> ,	UL: 300 V / 10 A / AWG 26 - AWG 12	
Qty.	70 pc(s).	Box		
Type	BLDT 5.08/04/-B SN BK BX	Version	Product data	Packaging
Order No.	<a href="#">1673800000</a>	PCB plug-in connector, female plug, 5.08 mm, Number of poles: 4,	IEC: 400 V / 14 A / 0.2 - 2.5 mm <sup>2</sup>	Box
GTIN (EAN)	4008190435530	180°, Clamping yoke connection, Clamping range, max. : 3.31 mm <sup>2</sup> ,	UL: 300 V / 10 A / AWG 26 - AWG 12	
Qty.	70 pc(s).	Box		

**BLF 5.08HC/90 SN**

Just as reliable as the millionfold proven original and featuring innovative details:  
The BLF 5.08HC PUSH IN version of the BLZP 5.08HC female connector is not only different in terms of connection system; it also has a more compact design. Weidmüller's innovative PUSH IN spring connection system stands for the future of easy and tool-free wire connection. HC = High Current.  
In terms of versatility, the BLF 5.08HC offers just as much as the version which served as a model:

- 3 tested-and-proven wire outlet directions provide the usual flexibility for application-specific design
- 4 flange variations and the patented release latch allow the locking concept to be based on the requirements of the user
- Use the BLF 5.08HC and SL 5.08HC plug combination to reach the max. rated specifications

**General ordering data**

Type	BLF 5.08HC/04/90 SN BK ...	Version	Product data	Packaging
Order No.	<a href="#">1000050001</a>	PCB plug-in connector, female plug, 5.08 mm, Number of poles: 4,	IEC: 400 V / 24 A / 0.2 - 2.5 mm <sup>2</sup>	Box
GTIN (EAN)	4032248689989	90°, PUSH IN, Spring connection, Clamping range, max. : 3.31 mm <sup>2</sup> ,	UL: 300 V / 18.5 A / AWG 26 - AWG 12	
Qty.	90 pc(s).	Box		
Type	BLF 5.08HC/04/90 SN OR ...	Version	Product data	Packaging
Order No.	<a href="#">1001550000</a>	PCB plug-in connector, female plug, 5.08 mm, Number of poles: 4,	IEC: 400 V / 24 A / 0.2 - 2.5 mm <sup>2</sup>	Box
GTIN (EAN)	4032248693351	90°, PUSH IN, Spring connection, Clamping range, max. : 3.31 mm <sup>2</sup> ,	UL: 300 V / 18.5 A / AWG 26 - AWG 12	
Qty.	90 pc(s).	Box		

**OMNIMATE Signal - series BL/SL 5.08  
SL-SMT 5.08HC/04/90G 1.5SN BK RL**

**Weidmüller Interface GmbH & Co. KG**  
Klingenbergstraße 26  
D-32758 Detmold  
Germany  
Fon: +49 5231 14-0  
Fax: +49 5231 14-292083  
www.weidmueller.com

**Mating connector (fully pluggable)**
**BLZ 5.00/270**

Female plugs with clamping-yoke screw for wire connection with 270° outlet direction. The female plugs provide space for labelling and can be coded.

**General ordering data**

Type	BLZ 5.00/04/270 SN DKGN ...	Version	Product data	Packaging
Order No.	<a href="#">1649910000</a>	PCB plug-in connector, female plug, 5.00 mm, Number of poles: 4,	IEC: 400 V / 15 A / 0.5 - 2.5 mm <sup>2</sup>	Box
GTIN (EAN)	4008190296490	270°, Clamping yoke connection, Clamping range, max. : 3.31 mm <sup>2</sup> ,	UL: 300 V / 10 A / AWG 26 - AWG 12	
Qty.	100 pc(s).	Box		

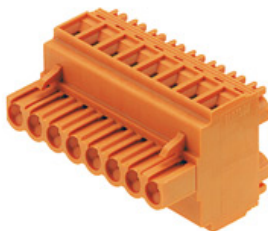
**BLDT 5.08**

Female plugs with two clamping-yoke screw connections per pole for wire connections with 90° and 270° outlet directions. The female plugs provide space for labelling and can be coded.

**General ordering data**

Type	BLDT 5.08/04/- SN OR BX	Version	Product data	Packaging
Order No.	<a href="#">1644750000</a>	PCB plug-in connector, female plug, 5.08 mm, Number of poles: 4,	IEC: 400 V / 14 A / 0.2 - 2.5 mm <sup>2</sup>	Box
GTIN (EAN)	4008190283964	180°, Clamping yoke connection, Clamping range, max. : 3.31 mm <sup>2</sup> ,	UL: 300 V / 10 A / AWG 26 - AWG 12	
Qty.	75 pc(s).	Box		
Type	BLDT 5.08/04/- SN BK BX	Version	Product data	Packaging
Order No.	<a href="#">1660730000</a>	PCB plug-in connector, female plug, 5.08 mm, Number of poles: 4,	IEC: 400 V / 14 A / 0.2 - 2.5 mm <sup>2</sup>	Box
GTIN (EAN)	4008190417185	180°, Clamping yoke connection, Clamping range, max. : 3.31 mm <sup>2</sup> ,	UL: 300 V / 10 A / AWG 26 - AWG 12	
Qty.	75 pc(s).	Box		

**OMNIMATE Signal - series BL/SL 5.08  
SL-SMT 5.08HC/04/90G 1.5SN BK RL**

**Weidmüller Interface GmbH & Co. KG**  
Klingenbergstraße 26  
D-32758 Detmold  
Germany  
Fon: +49 5231 14-0  
Fax: +49 5231 14-292083  
www.weidmueller.com

**Mating connector (fully pluggable)**
**BLZP 5.08HC/225 SN**

Clamping-yoke connection with right-angled (90° or 270°) or angled (225°) outlet direction. The female connectors provide space for labelling and can be coded. Fastened by means of a flange or release latch. They also provide an integrated plus/minus screw, protection against faulty insertion of the wire, and they are delivered with open clamping yokes. HC = High Current.

**General ordering data**

Type	BLZP 5.08HC/04/225 SN O ...	Version	Product data	Packaging
Order No.	<a href="#">1946270000</a>	PCB plug-in connector, female plug, 5.08 mm, Number of poles: 4,	IEC: 400 V / 17.5 A / 0.2 - 4 mm <sup>2</sup>	Box
GTIN (EAN)	4032248621842	225°, Clamping yoke connection, Clamping range, max. : 4 mm <sup>2</sup> , Box	UL: 300 V / 15 A / AWG 26 - AWG 12	
Qty.	90 pc(s).			
Type	BLZP 5.08HC/04/225 SN B ...	Version	Product data	Packaging
Order No.	<a href="#">1946580000</a>	PCB plug-in connector, female plug, 5.08 mm, Number of poles: 4,	IEC: 400 V / 17.5 A / 0.2 - 4 mm <sup>2</sup>	Box
GTIN (EAN)	4032248622351	225°, Clamping yoke connection, Clamping range, max. : 4 mm <sup>2</sup> , Box	UL: 300 V / 15 A / AWG 26 - AWG 12	
Qty.	90 pc(s).			

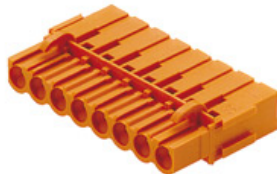
**BLC 5.08BR**

Female plugs with crimp wire connection system. The female plugs provide space for labelling and can be coded.

**General ordering data**

Type	BLC 5.08/04/180BR OR BX	Version	Product data	Packaging
Order No.	<a href="#">1649390000</a>	PCB plug-in connector, female plug, 5.08 mm, Number of poles: 4,	IEC: 400 V / 21 A	Box
GTIN (EAN)	4008190294502	180°, Crimp connection, Clamping range, max. : 2.5 mm <sup>2</sup> , Box	UL: 300 V / 10 A / AWG 26 - AWG 14	
Qty.	100 pc(s).			
Type	BLC 5.08/04/180BR BK BX	Version	Product data	Packaging
Order No.	<a href="#">1712130000</a>	PCB plug-in connector, female plug, 5.08 mm, Number of poles: 4,	IEC: 400 V / 21 A	Box
GTIN (EAN)	4008190935146	180°, Crimp connection, Clamping range, max. : 2.5 mm <sup>2</sup> , Box	UL: 300 V / 10 A / AWG 26 - AWG 14	
Qty.	100 pc(s).			

**OMNIMATE Signal - series BL/SL 5.08  
SL-SMT 5.08HC/04/90G 1.5SN BK RL**

**Weidmüller Interface GmbH & Co. KG**  
Klingenbergstraße 26  
D-32758 Detmold  
Germany  
Fon: +49 5231 14-0  
Fax: +49 5231 14-292083  
www.weidmueller.com

**Mating connector (fully pluggable)**
**BLF 5.08HC/180 SN**

Just as reliable as the millionfold proven original and featuring innovative details:  
The BLF 5.08HC PUSH IN version of the BLZP 5.08HC female connector is not only different in terms of connection system; it also has a more compact design. Weidmüller's innovative PUSH IN spring connection system stands for the future of easy and tool-free wire connection. HC = High Current.  
In terms of versatility, the BLF 5.08HC offers just as much as the version which served as a model:

- 3 tested-and-proven wire outlet directions provide the usual flexibility for application-specific design
- 4 flange variations and the patented release latch allow the locking concept to be based on the requirements of the user
- Use the BLF 5.08HC and SL 5.08HC plug combination to reach the max. rated specifications

**General ordering data**

Type	BLF 5.08HC/04/180 SN BK ...	Version	Product data	Packaging
Order No.	<a href="#">1013450000</a>	PCB plug-in connector, female plug, 5.08 mm, Number of poles: 4,	IEC: 400 V / 24 A / 0.2 - 2.5 mm <sup>2</sup>	Box
GTIN (EAN)	4032248721603	180°, PUSH IN, Spring connection, Clamping range, max. : 3.31 mm <sup>2</sup> , UL: 300 V / 18.5 A / AWG 26 - AWG		
Qty.	90 pc(s).	Box	12	
Type	BLF 5.08HC/04/180 SN OR ...	Version	Product data	Packaging
Order No.	<a href="#">1013710000</a>	PCB plug-in connector, female plug, 5.08 mm, Number of poles: 4,	IEC: 400 V / 24 A / 0.2 - 2.5 mm <sup>2</sup>	Box
GTIN (EAN)	4032248721825	180°, PUSH IN, Spring connection, Clamping range, max. : 3.31 mm <sup>2</sup> , UL: 300 V / 18.5 A / AWG 26 - AWG		
Qty.	90 pc(s).	Box	12	

**BLZP 5.08HC/180 SN**

Female plug with clamping-yoke screw system for connecting wires with straight (180°) outlet direction. The female connectors provide space for labelling and can be coded. Fastened by means of a flange or release latch. They also provide an integrated plus/minus screw, protection against faulty insertion of the wire, and they are delivered with open clamping yokes. HC = High Current.

**General ordering data**

Type	BLZP 5.08HC/04/180 SN O ...	Version	Product data	Packaging
Order No.	<a href="#">1943600000</a>	PCB plug-in connector, female plug, 5.08 mm, Number of poles: 4,	IEC: 400 V / 23 A / 0.2 - 4 mm <sup>2</sup>	Box
GTIN (EAN)	4032248617593	180°, Clamping yoke connection, Clamping range, max. : 4 mm <sup>2</sup> , Box	UL: 300 V / 20 A / AWG 26 - AWG 12	
Qty.	90 pc(s).			
Type	BLZP 5.08HC/04/180 SN B ...	Version	Product data	Packaging
Order No.	<a href="#">1943830000</a>	PCB plug-in connector, female plug, 5.08 mm, Number of poles: 4,	IEC: 400 V / 23 A / 0.2 - 4 mm <sup>2</sup>	Box
GTIN (EAN)	4032248617869	180°, Clamping yoke connection, Clamping range, max. : 4 mm <sup>2</sup> , Box	UL: 300 V / 20 A / AWG 26 - AWG 12	
Qty.	90 pc(s).			

**OMNIMATE Signal - series BL/SL 5.08  
SL-SMT 5.08HC/04/90G 1.5SN BK RL**

**Weidmüller Interface GmbH & Co. KG**  
 Klingenbergstraße 26  
 D-32758 Detmold  
 Germany  
 Fon: +49 5231 14-0  
 Fax: +49 5231 14-292083  
 www.weidmueller.com

**Mating connector (fully pluggable)**
**BLL 5.08/90**

Female header for PCB mounting. The solder pin length is optimised for wave flow soldering.

**General ordering data**

Type	Version	Product data	Packaging
BLL 5.08/04/90 3.2 SN O ...	PCB plug-in connector, female header, closed side, THT solder connection, 5.08 mm, Number of poles: 4, 90°, Solder pin length (l): 3.2 mm, tinned, orange, Box	IEC: 400 V / 23 A UL: 300 V / 15 A	Box
Order No. <a href="#">1622960000</a>			
GTIN (EAN) 4008190194024			
Qty. 90 pc(s).			
BLL 5.08/04/90 4.5 SN B ...	PCB plug-in connector, female header, closed side, THT solder connection, 5.08 mm, Number of poles: 4, 90°, Solder pin length (l): 4.5 mm, tinned, black, Box	IEC: 400 V / 23 A UL: 300 V / 15 A	Box
Order No. <a href="#">1646050000</a>			
GTIN (EAN) 4008190285395			
Qty. 90 pc(s).			

**BLZ 5.00/180**

Female plugs with clamping-yoke screw for wire connection with straight (180°) outlet direction. The female plugs provide space for labelling and can be coded.

**General ordering data**

Type	Version	Product data	Packaging
BLZ 5.00/04/180 SN DKGN ...	PCB plug-in connector, female plug, 5.00 mm, Number of poles: 4, 180°, Clamping yoke connection, Clamping range, max. : 3.31 mm², UL: 300 V / 15 A / AWG 26 - AWG 12	IEC: 400 V / 19 A / 0.5 - 2.5 mm² UL: 300 V / 15 A / AWG 26 - AWG 12	Box
Order No. <a href="#">1646840000</a>			
GTIN (EAN) 4008190288051			
Qty. 100 pc(s).			



**OMNIMATE Signal - series BL/SL 5.08  
SL-SMT 5.08HC/04/90G 1.5SN BK RL**

**Weidmüller Interface GmbH & Co. KG**  
Klingenbergstraße 26  
D-32758 Detmold  
Germany  
Fon: +49 5231 14-0  
Fax: +49 5231 14-292083  
www.weidmueller.com

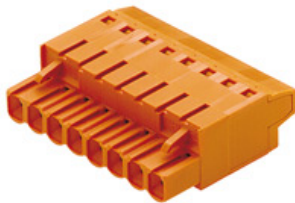
**Mating connector (fully pluggable)**
**BLT 5.08HC**

Female plugs with TOP screw connection system for connecting wires with straight 180° outlet direction. The female connectors provide space for labelling and can be coded. HC = High Current.

**General ordering data**

Type	BLT 5.08HC/04/180 SN BL ...	Version	Product data	Packaging
Order No.	<a href="#">1499780000</a>	PCB plug-in connector, female plug, 5.08 mm, Number of poles: 4,	IEC: 400 V / 27 A / 0.2 - 2.5 mm <sup>2</sup>	Box
GTIN (EAN)	4032248015467	180°, TOP connection, Clamping range, max. : 2.5 mm <sup>2</sup> , Box	UL: 300 V / 17 A / AWG 26 - AWG 14	
Qty.	90 pc(s).			

**BLZP 5.08HC/270 SN**

Female plugs with clamping-yoke connection for connecting wires with a right-angle (90° or 270°) outlet direction. The female connectors provide space for labelling and can be coded. Fastened by means of a flange or release latch. They also provide an integrated plus/minus screw, protection against faulty insertion of the wire, and they are delivered with open clamping yokes. HC = High Current.

**General ordering data**

Type	BLZP 5.08HC/04/270 SN O ...	Version	Product data	Packaging
Order No.	<a href="#">1948810000</a>	PCB plug-in connector, female plug, 5.08 mm, Number of poles: 4,	IEC: 400 V / 23 A / 0.2 - 4 mm <sup>2</sup>	Box
GTIN (EAN)	4032248626267	270°, Clamping yoke connection, Clamping range, max. : 4 mm <sup>2</sup> , Box	UL: 300 V / 20 A / AWG 26 - AWG 12	
Qty.	90 pc(s).			

**OMNIMATE Signal - series BL/SL 5.08  
SL-SMT 5.08HC/04/90G 1.5SN BK RL**

**Weidmüller Interface GmbH & Co. KG**  
 Klingenbergstraße 26  
 D-32758 Detmold  
 Germany  
 Fon: +49 5231 14-0  
 Fax: +49 5231 14-292083  
 www.weidmueller.com

**Accessories****LED Light guides****Effective: the link between LED and front panel.**

Floodlight indicators allow users to monitor the switching states without requiring a special design: optical plastic directs the light from standard LEDs around a bend into the connectors or through the front plate.

The fibre-optic elements are simply clipped behind the relevant 90° bend male connectors (90° outlet direction). Versions with different incoming light beam heights achieve maximum light efficiency for LEDs with different designs or heights.

The advantages compared to conventional solutions:

- No additional LED circuit board required behind the front panel
- No "long-legged" LEDs with separate mounting required
- Bent fibre-optic cable line for maximum light efficiency
- Uncomplicated front plate bore holes due to circular shape of outgoing light beam
- Easy to maintain correct clearance and creepage distance
- Can be partitioned for smaller pole numbers

The result: simplified manufacturing process, reduced costs and simplified design

**General ordering data**

Type	SL FLA 3.8/1	Version	Product data	Packaging
Order No.	<a href="#">1580110000</a>	PCB plug-in connector, Accessories, Flood-light display, Transparent,		Box
GTIN (EAN)	4008190050740	Number of poles: 1		
Qty.	100 pc(s).			
Type	SL FLA 2,3/1	Version	Product data	Packaging
Order No.	<a href="#">1636670000</a>	PCB plug-in connector, Accessories, Flood-light display, Transparent,		Box
GTIN (EAN)	4008190409975	Number of poles: 1		
Qty.	100 pc(s).			
Type	SL FLA 2,3/24	Version	Product data	Packaging
Order No.	<a href="#">1636680000</a>	PCB plug-in connector, Accessories, Flood-light display, Transparent,		Box
GTIN (EAN)	4008190409968	Number of poles: 1		
Qty.	10 pc(s).			
Type	SL FLA 3.8/24	Version	Product data	
Order No.	<a href="#">1595860000</a>	PCB plug-in connector, Accessories, Flood-light display, Transparent,		
GTIN (EAN)	4008190140892	Number of poles: 1		
Qty.	10 pc(s).			
Type	SL FLA 9.0/24	Version	Product data	
Order No.	<a href="#">1595870000</a>	PCB plug-in connector, Accessories, Flood-light display, Transparent,		
GTIN (EAN)	4008190079796	Number of poles: 1		
Qty.	10 pc(s).			
Type	SL FLA 9.0/1	Version	Product data	Packaging
Order No.	<a href="#">1580120000</a>	PCB plug-in connector, Accessories, Flood-light display, Transparent,		Box
GTIN (EAN)	4008190031909	Number of poles: 1		
Qty.	100 pc(s).			

## OMNIMATE Signal - series BL/SL 5.08 SL-SMT 5.08HC/04/90G 1.5SN BK RL

**Weidmüller Interface GmbH & Co. KG**  
 Klingenbergstraße 26  
 D-32758 Detmold  
 Germany  
 Fon: +49 5231 14-0  
 Fax: +49 5231 14-292083  
 www.weidmueller.com

## Accessories

Type	SL FLA 1.5/1	Version	Product data	Packaging
Order No.	<a href="#">1580100000</a>	PCB plug-in connector, Accessories, Flood-light display, Transparent,		Box
GTIN (EAN)	4008190152475	Number of poles: 1		
Qty.	100 pc(s).			
Type	SL FLA 1.5/24	Version	Product data	
Order No.	<a href="#">1595850000</a>	PCB plug-in connector, Accessories, Flood-light display, Transparent,		
GTIN (EAN)	4008190092573	Number of poles: 1		
Qty.	10 pc(s).			

## Coding elements



### Only connects what is supposed to be connected: the right connection at the right place.

Coding elements and locking devices clearly assign connecting elements during the manufacturing process and operation

The coding elements and locking devices are inserted prior to assembly or during the cable assembly phase. The Weidmüller alternative: configure online using the variant configurator to precode prior to delivery.

Incorrect assembly on the circuit board and incorrect plugging of connecting elements is no longer possible. The advantage: no troubleshooting during manufacture and no operational errors by the user.

## General ordering data

Type	BLZ/SL KO OR BX	Version	Product data	Packaging
Order No.	<a href="#">1573010000</a>	PCB plug-in connector, Accessories, Coding element, orange, Number		Box
GTIN (EAN)	4008190048396	of poles: 1		
Qty.	100 pc(s).			
Type	BLZ/SL KO BK BX	Version	Product data	Packaging
Order No.	<a href="#">1545710000</a>	PCB plug-in connector, Accessories, Coding element, black, Number		Box
GTIN (EAN)	4008190087142	of poles: 1		
Qty.	50 pc(s).			

## OMNIMATE Signal - series BL/SL 5.08 SL-SMT 5.08HC/04/90G 1.5SN BK RL

**Weidmüller Interface GmbH & Co. KG**  
 Klingenbergstraße 26  
 D-32758 Detmold  
 Germany  
 Fon: +49 5231 14-0  
 Fax: +49 5231 14-292083  
 www.weidmueller.com

# Accessories

### Additional accessories



### No task is too small when creating the perfect solution.

Connections form just one part of the overall process. Small details are often the key to the perfect solution in applications where potentials are tested, grouped or even isolated.

A system is not a system without small but useful details:

- Test plugs - ensure reliable pick-up from diagnostic sockets
- Cross-connectors - ensure a stable electrical distribution contact directly at the connection
- Compartment partition elements - divide a large number of male connectors into several separate socket connector channels
- Locks and clips - optional vibration-resistant clip-on connection or mounting for male and female connectors

In tandem with the manufacturing process and application - more accessories = smaller workload

### General ordering data

Type	SL AT SW	Version	Product data	Packaging
Order No.	<a href="#">1770240000</a>	PCB plug-in connector, Accessories, Spacer, black, Number of poles: 1		Box
GTIN (EAN)	4032248117710			
Qty.	100 pc(s).			
Type	SL AT OR	Version	Product data	Packaging
Order No.	<a href="#">1598300000</a>	PCB plug-in connector, Accessories, Spacer, orange, Number of poles: 1		Box
GTIN (EAN)	4008190189266			
Qty.	100 pc(s).			

**OMNIMATE Signal - series BL/SL 5.08  
SL-SMT 5.08HC/04/90G 1.5SN BK RL**

**Weidmüller Interface GmbH & Co. KG**  
Klingenbergstraße 26  
D-32758 Detmold  
Germany  
Fon: +49 5231 14-0  
Fax: +49 5231 14-292083  
www.weidmueller.com

**Drawings**

**Dimensional drawing**

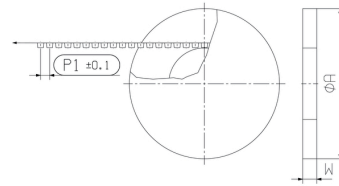

**Dimensional drawing**

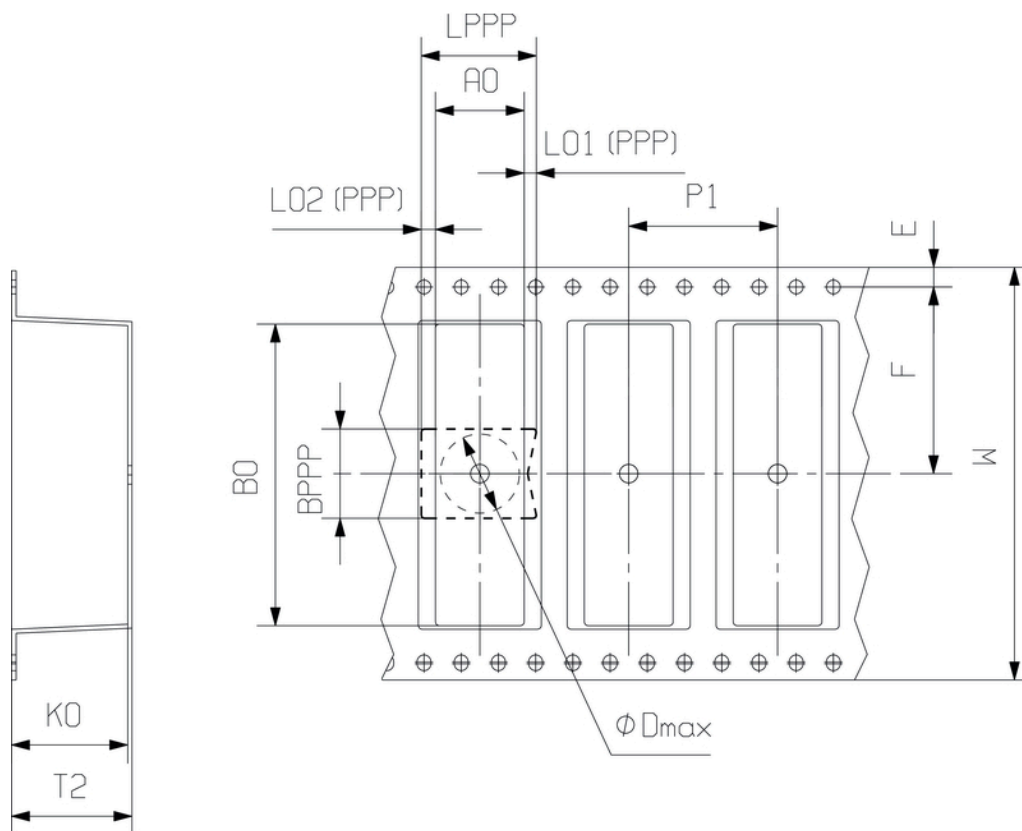

## Recommended wave soldering profiles

**Weidmüller Interface GmbH & Co. KG**  
 Klängenbergstraße 16  
 D-32758 Detmold  
 Germany  
 Fon: +49 5231 14-0  
 Fax: +49 5231 14-292083  
 www.weidmueller.com

### Single Wave:



### Double Wave:



### Wave soldering profiles

Wired connection elements should be processed in accordance with the DIN EN 61760-1 standard. We have included two recommendations for practical wave soldering profiles, with which Weidmüller PCB terminals and connectors are qualified.

When choosing a suitable profile for your application, the following factors also need to be considered:

- PCB thickness
- Proportion of Cu in the layers
- Single/double-sided assembly
- Product range
- Heating and cooling rates

The single and double wave profiles each indicate the recommended operating range, including the maximum soldering temperature of 260°C. In practice, the maximum soldering temperature is quite often well below the above maximum profile.

## Recommended reflow soldering profile

**Weidmüller Interface GmbH & Co. KG**  
 Klingenbergstraße 16  
 D-32758 Detmold  
 Germany  
 Fon: +49 5231 14-0  
 Fax: +49 5231 14-292083  
 www.weidmueller.com

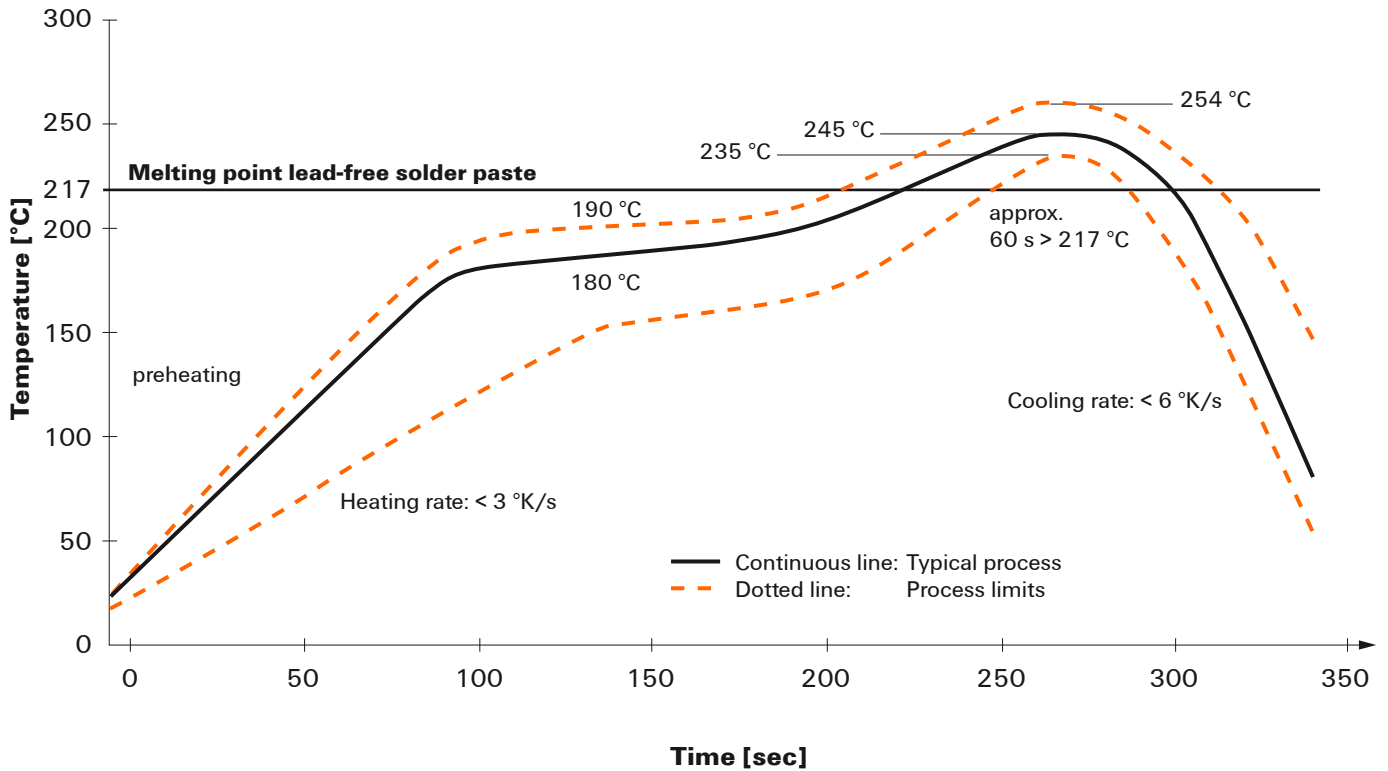

### Reflow soldering profile

The perfect soldering profile for SMT Surface Mount Technology is one the most exiting question in SMT production. But there are more than one correct answer: The diagram of temperature-on-time is related to processing features of solder paste and to maximum load of components.

We have to consider the following parameters:

- Time for pre heating
- Maximum temperature
- Time above melting point
- Time for cooling
- Maximum heating rate
- Maximum cooling rate

We recommend a typical solder profile with associated process limits. With preheating components and board are prepared smoothly for the solder phase. Heating rate is typically  $\leq +3\text{K/s}$ . In parallel the solder paste is ‚activated‘. The time above melting point of 217°C the paste gets liquid and components and boards begin to connect. The maximum temperature of 245°C to 254°C should stay between 10 and 40 seconds. In the cooling phase at  $\geq -6\text{K/s}$  solder is cured. Board and components cool down while avoiding cold cracks.