

OMNIMATE Signal - series LM LM2N 3.50/28/90 3.2SN OR BX

Weidmüller Interface GmbH & Co. KG
Klingenbergstraße 26
D-32758 Detmold
Germany
Fon: +49 5231 14-0
Fax: +49 5231 14-292083
www.weidmueller.com

Product image



Similar to illustration

Small, compact PCB terminal or -tier PCB terminal with proven clamping yoke connection and 3.5 mm pitch. Suitable for conductor cross-sections up to 1.5 mm².

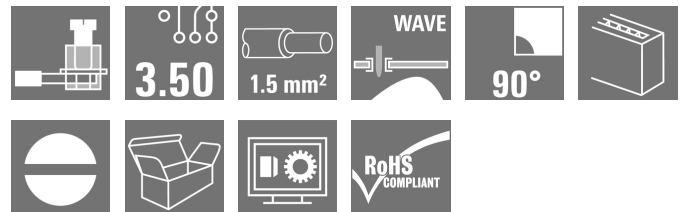

General ordering data

Type	LM2N 3.50/28/90 3.2SN OR BX
Order No.	1703820000
Version	Printed circuit board terminals, 3.50 mm, Number of poles: 28, 90°, Solder pin length (l): 3.2 mm, tinned, orange, Clamping yoke connection, Clamping range, max. : 2.08 mm ² , Box
GTIN (EAN)	4008 1909 1089 1
Qty.	25 pc(s).
Product data	IEC: 320 V / 13 A / 0.5 - 1.5 mm ² UL: 300 V / 10 A / AWG 28 - AWG 14
Packaging	Box

Creation date May 3, 2020 12:38:56 PM CEST

**OMNIMATE Signal - series LM
LM2N 3.50/28/90 3.2SN OR BX**

Weidmüller Interface GmbH & Co. KG
 Klingenbergstraße 26
 D-32758 Detmold
 Germany
 Fon: +49 5231 14-0
 Fax: +49 5231 14-292083
 www.weidmueller.com

Technical data**Dimensions and weights**

Width	51.35 mm	Width (inches)	2.022 inch
Height	27.3 mm	Height (inches)	1.075 inch
Height of lowest version	24.1 mm	Depth	16.75 mm
Depth (inches)	0.659 inch	Net weight	21.4 g

System parameters

Product family	OMNIMATE Signal - series LM	Wire connection method	Clamping yoke connection
Mounting onto the PCB	THT solder connection	Conductor outlet direction	90°
Pitch in mm (P)	3.5 mm	Pitch in inches (P)	0.138 inch
Number of poles	28	Fitted by customer	Yes
Max. adjacent poles per row	24	Solder pin length (l)	3.2 mm
Solder pin dimensions	1.0 x 0.6 mm	Solder eyelet hole diameter (D)	1.3 mm
Solder eyelet hole diameter tolerance (D)+	0, 1 mm	Number of solder pins per pole	1
Screwdriver blade	0.4 x 2.5	Screwdriver blade standard	DIN 5264
Tightening torque, min.	0.2 Nm	Tightening torque, max.	0.2 Nm
Clamping screw	M 2	Stripping length	5 mm
L1 in mm	45.5 mm	L1 in inches	1.791 inch
Touch-safe protection acc. to DIN VDE 0470	IP 20	Touch-safe protection acc. to DIN VDE 57 106	Safe from finger touch
Volume resistance	3.60 mΩ		

Material data

Insulating material	PA	Colour	orange
Colour chart (similar)	RAL 2000	Insulating material group	I
Comparative Tracking Index (CTI)	≥ 600	Insulation strength	≥ 10 ⁸ Ω
UL 94 flammability rating	V-2	Contact material	Copper alloy
Contact surface	tinned	Coating	1-3 μm Ni, 4-6 μm Sn
Tinning type	matt	Layer structure of solder connection	1.5-3 μm Ni / 4-6 μm Sn matt
Storage temperature, min.	-25 °C	Storage temperature, max.	50 °C
Max. relative humidity during storage	70 %	Operating temperature, min.	-50 °C
Operating temperature, max.	100 °C	Temperature range, installation, min.	-25 °C
Temperature range, installation, max.	100 °C		

Conductors suitable for connection

Clamping range, min.	0.08 mm ²
Clamping range, max.	2.08 mm ²
Wire connection cross section AWG, min.	AWG 28
Wire connection cross section AWG, max.	AWG 14
Solid, min. H05(07) V-U	0.5 mm ²
Solid, max. H05(07) V-U	1.5 mm ²
Flexible, min. H05(07) V-K	0.5 mm ²
Flexible, max. H05(07) V-K	1.5 mm ²
w. plastic collar ferrule, DIN 46228 pt 4, min.	0.5 mm ²
w. plastic collar ferrule, DIN 46228 pt 4, max.	0.75 mm ²
Plug gauge in accordance with EN 60999 a x b; ø	2.4 mm x 1.5 mm

Creation date May 3, 2020 12:38:56 PM CEST

**OMNIMATE Signal - series LM
LM2N 3.50/28/90 3.2SN OR BX**

Weidmüller Interface GmbH & Co. KG
 Klingenbergstraße 26
 D-32758 Detmold
 Germany
 Fon: +49 5231 14-0
 Fax: +49 5231 14-292083
 www.weidmueller.com

Technical data

Clampable conductor	Cross-section for conductor connection	Type	fine-wired
	wire end ferrule	nominal	0.75 mm ²
Reference text	Length of ferrules is to be chosen depending on the product and the rated voltage., The outside diameter of the plastic collar should not be larger than the pitch (P)	Stripping length	nominal 8 mm
		Recommended wire-end ferrule	HO.75/12 W
Max. clamping range	2.08 mm ²		

Rated data acc. to IEC

tested acc. to standard	IEC 60664-1, IEC 61984	Rated current, min. number of poles (Tu=20°C)	13 A
Rated current, max. number of poles (Tu=20°C)	12 A	Rated current, min. number of poles (Tu=40°C)	11 A
Rated current, max. number of poles (Tu=40°C)	10 A	Rated voltage for surge voltage class / pollution degree II/2	320 V
Rated voltage for surge voltage class / pollution degree III/2	160 V	Rated voltage for surge voltage class / pollution degree III/3	160 V
Rated impulse voltage for surge voltage class/ pollution degree II/2	2.5 kV	Rated impulse voltage for surge voltage class/ pollution degree III/2	2.5 kV
Rated impulse voltage for surge voltage class/ contamination degree III/3	2.5 kV	Short-time withstand current resistance	3 x 1s with 72 A

Rated data acc. to CSA

Institute (CSA)		Certificate No. (CSA)	154685-1202192
Rated voltage (Use group B / CSA)	300 V	Rated voltage (Use group D / CSA)	300 V
Rated current (Use group B / CSA)	10 A	Rated current (Use group D / CSA)	10 A
Wire cross-section, AWG, min.	AWG 28	Wire cross-section, AWG, max.	AWG 14
Reference to approval values	Specifications are maximum values, details - see approval certificate.		

Rated data acc. to UL 1059

Institute (UR)		Certificate No. (UR)	E60693
Rated voltage (Use group B / UL 1059)	300 V	Rated voltage (Use group D / UL 1059)	300 V
Rated current (Use group B / UL 1059)	10 A	Rated current (Use group D / UL 1059)	10 A
Wire cross-section, AWG, min.	AWG 28	Wire cross-section, AWG, max.	AWG 14
Reference to approval values	Specifications are maximum values, details - see approval certificate.		

Packing

Packaging	Box	VPE length	51 mm
VPE width	77 mm	VPE height	192 mm

OMNIMATE Signal - series LM LM2N 3.50/28/90 3.2SN OR BX

Weidmüller Interface GmbH & Co. KG
 Klingenbergstraße 26
 D-32758 Detmold
 Germany
 Fon: +49 5231 14-0
 Fax: +49 5231 14-292083
 www.weidmueller.com

Technical data

Classifications

ETIM 6.0	EC002643	ETIM 7.0	EC002643
eClass 9.0	27-44-04-01	eClass 9.1	27-44-04-01
eClass 10.0	27-44-04-01	UNSPSC	30-21-18-01

Notes

- Notes
- Additional colours on request
 - Rated current related to rated cross-section & min. No. of poles.
 - Max. outer diameter of the conductor: 2.9 mm
 - Wire end ferrule with plastic collar to DIN 46228/4
 - P on drawing = pitch
 - Rated data refer only to the component itself. Clearance and creepage distances to other components are to be designed in accordance with the relevant application standards.

IPC conformity
 Conformity: The products are developed, manufactured and delivered according international recognized standards and norms and comply with the assured properties in the data sheet resp. fulfill decorative properties in accordance with IPC-A-610 "Class 2". Further claims on the products can be evaluated on request.

Approvals

Approvals



ROHS Conform

Downloads

Approval/Certificate/Document of Conformity	Declaration of the Manufacturer
Brochure/Catalogue	FL DRIVES EN FL ANALO.SIGN.CONV. EN MB DEVICE MANUF. EN FL DRIVES DE CAT 2 PORTFOLIOGUIDE EN FL BUILDING SAFETY EN FL APPL LED LIGHTING EN FL INDUSTR.CONTROLS EN FL MACHINE SAFETY EN FL HEATING ELECTR EN FL APPL INVERTER EN FL_BASE_STATION_EN FL ELEVATOR EN FL POWER SUPPLY EN FL 72H SAMPLE SER EN PO OMNIMATE EN
Engineering Data	EPLAN, WSCAD
Engineering Data	LM2N.zip

Data sheet

**OMNIMATE Signal - series LM
LM2N 3.50/28/90 3.2SN OR BX**

Weidmüller Interface GmbH & Co. KG
 Klingenbergstraße 26
 D-32758 Detmold
 Germany
 Fon: +49 5231 14-0
 Fax: +49 5231 14-292083
 www.weidmueller.com

Drawings

Dimensional drawing

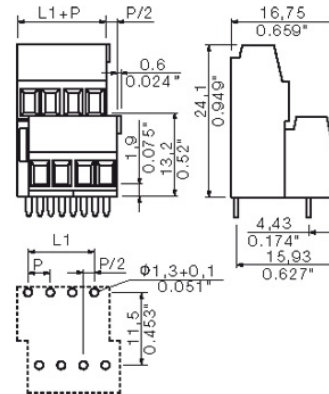

Graph

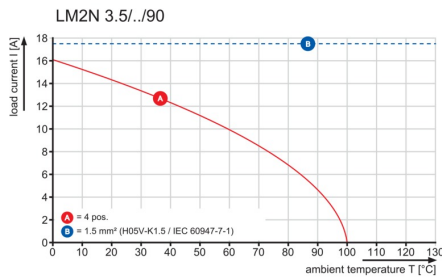

**OMNIMATE Signal - series LM
LM2N 3.50/28/90 3.2SN OR BX**

Weidmüller Interface GmbH & Co. KG
Klingenbergstraße 26
D-32758 Detmold
Germany
Fon: +49 5231 14-0
Fax: +49 5231 14-292083
www.weidmueller.com

Accessories

Slotted screwdriver

Slotted screwdriver with rounded blade SD DIN 5265, ISO 2380/2, output to DIN 5264, ISO 2380/1. ChromTop tip, SoftFinish grip



General ordering data

Type	SDS 0.4X2.5X75	Version
Order No.	9009030000	Screwdriver, Blade width (B): 2.5 mm, Blade length: 75 mm, Blade thickness (A): 0.4 mm
GTIN (EAN)	4032248266944	
Qty.	1 pc(s).	

Slotted screwdriver

VDE insulated slot-head screwdriver, SDI DIN 7437, ISO 2380/2, drive output acc. to DIN 5264, ISO 2380/1. SoftFinish grip



General ordering data

Type	SDIS 0.4X2.5X75	Version
Order No.	9008370000	Screwdriver, Blade width (B): 2.5 mm, Blade length: 75 mm, Blade thickness (A): 0.4 mm
GTIN (EAN)	4032248056330	
Qty.	1 pc(s).	

WEITERGABE SOWIE Vervielfältigung dieses Dokuments, Verwertung und Mitteilung seines Inhalts sind verboten, soweit nicht ausdrücklich gestattet. Zuwiderhandlungen verpflichten zu Schadenersatz. Alle Rechte für den Fall der Patent-, Gebrauchsmuster- oder Geschmacksmusterertragsvorbehalten. THE REPRODUCTION, DISTRIBUTION AND UTILIZATION OF THIS DOCUMENT AS WELL AS THE COMMUNICATION OF ITS CONTENTS TO OTHERS WITHOUT EXPLICIT AUTHORIZATION IS PROHIBITED. OFFENDERS WILL BE HELD LIABLE FOR THE PAYMENT OF DAMAGES. WEIDMÜLLER EXCLUSIVELY RESERVES THE RIGHT TO FILE FOR PATENTS, UTILITY MODELS OR DESIGNS.

Technical Data

Rev.

Material data

Insulation material type	PA 66
Insulation material colours	orange/black
Insulation material flammability class	UL94 V - 2
Insulation resistance	MOhm 10 ³
Contact base material	Cu-alloy
Contact plating	tin-plated

System characteristic values

Pitch P	mm/inch	3.5/0.138
Number of rows		2
Dielectric strength (r.m.s withstand voltage)	kV	>1.5
Through resistance (typical)	mOhm	2.2
Operating temperature range	°C	-55°...+100° 1)
Degree of protection acc. to VDE 0106		finger safe
Degree of protection acc. to DIN EN 60529		IP20
Conductor connection method		clamping yoke
Screw size		M2
Screw torque max. acc. to EN 60999	Nm	0.2
Screw driver type		SDI 0.4x2.5
Solder pin length L	mm/inch	3.2/0.126
PCB hole diameter D (wave soldering)	mm/inch	1.3+0.1/0.051+0.004 2)
PCB hole diameter D (reflow soldering)	mm/inch	n.a. 3)
Resistance to soldering heat acc. to DIN IEC 60512-6	°C/sec	260/10 4)
Resistance to soldering heat acc. to EN 61760-1	°C/sec	n.a. 5)
Solderability classification acc. to EN 61760-1		n.a.
Solder connection type		wave soldering
Solder pin diameter d (max.)	mm/inch	1.22/0.048

Application notes

Coding possibility	yes/no	no
Joinable without loss of pitch	yes/no	no
Manual assembly of modules	yes/no	yes
Max. number of poles	n	48

Conductor

Clamping range	mm ²	0.08...1.5
"e" solid H05(07) V-U	mm ²	0.08...1.5
"f" flexible H05(07) V-K	mm ²	0.08...1.5
"f" with ferrule acc. to DIN 46228/1	mm ²	n.a.
... with plastic collar acc. to DIN 46228/4	mm ²	n.a.
Conductor insulation stripping length	mm/inch	5/0.197
Conductor insulation diameter max.	mm/inch	n.a.
Two wire clamping range	mm ²	0.5
Gauge to EN 60999 (a x b ; Ø)	mm	2.4x1.5

IEC 664-1 / VDE0110 (4.97) rated data

Rated cross section acc. to EN 60999	mm ²	1.5
Rated current @ 20°C ambient	A	10 6)
Rated current @ 40°C ambient	A	8.5 6)

Overvoltage category / Pollution degree

Rated voltage	V	III/3	III/2	II/2
Rated impulse voltage	kV	160	160	320
		2.5	2.5	2.5

UL 1059 rated data

File No.: E60693

Rated voltage	B	C	D
	300	---	300
Rated current	10	---	10
AWG wire range (field wiring / factory wiring)	28...14		

CSA C22.2 rated data

File No.: LR12400

Rated voltage	B	C	D
	300	---	300
Rated current	10	---	10
AWG wire range (field wiring / factory wiring)	28...14		

Packaging

carton

Downloads

www.weidmueller.de

- 1) Sum of ambient temperature and temperature rise
- 2) Recommendation for manual assembly
- 3) Recommendation for automatic assembly
- 4) Recommendation for wave soldering
- 5) Recommendation for reflow soldering
- 6) Referred to rated cross section and 12 pole number

n.a. = not applicable

Subject to technical changes

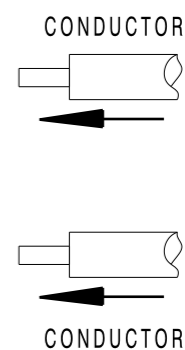
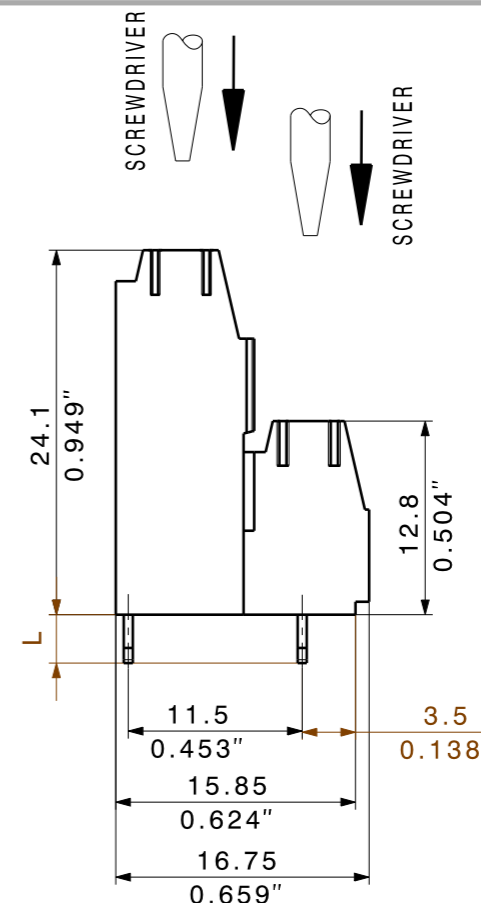
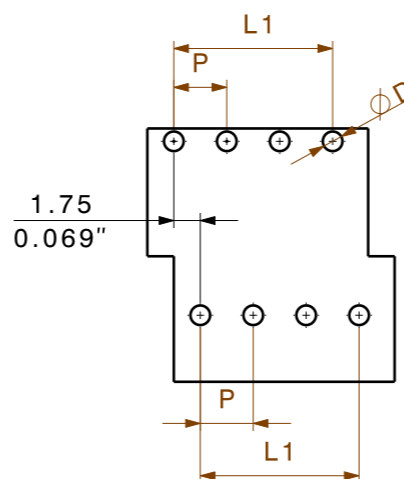
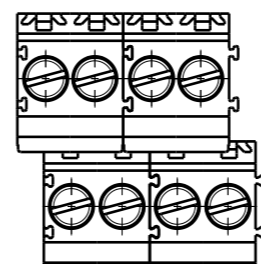
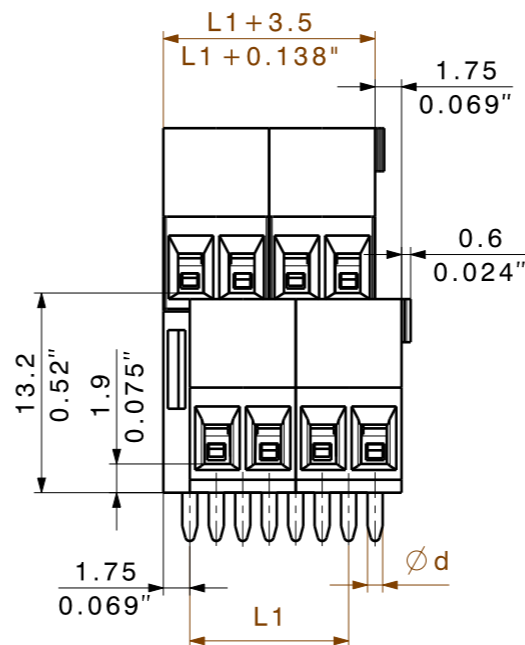

DIE DEUTSCHE VERSION IST VERBINDLICH
THE GERMAN VERSION IS BINDING

48	80,50	3,169
46	77,00	3,031
44	73,50	2,894
42	70,00	2,756
40	66,50	2,618
38	63,00	2,480
36	59,50	2,343
34	56,00	2,205
32	52,50	2,067
30	49,00	1,929
28	45,50	1,791
26	42,00	1,654
24	38,50	1,516
22	35,00	1,378
20	31,50	1,240
18	28,00	1,102
16	24,50	0,965
14	21,00	0,827
12	17,50	0,689
10	14,00	0,551
8	10,50	0,413
6	7,00	0,276
4	3,50	0,138
n	L1 [mm]	L1 [inch]

SHOWN LM2N3.5/8/90

	METRIC TOLERANCES X. = ±0.3 X.X = ±0.1 X.XX = ±0.05	CAT.NO.:	
	43264/5 17.06.09 HELIS_MA 00	C 23209 08	
MODIFICATION		DRAWING NO.	ISSUE NO.
		SHEET 02 OF 03 SHEETS	
SCALE: 5/1 SUPERSEDES:	DATE 23.09.2008	NAME HELIS_MA	LM2N 3.5/././90 LEITERPLATTENANSCHLUSSKLEMME PCB TERMINAL
	RESPONSIBLE KRUG_M	CHECKED 18.06.2009 HECKERT_M	
	APPROVED HECKERT_M	PRODUCT FILE: LM1N 3.5	
			1111

For the mounting of PCBs, it should be noted that the rated data stated here relates only to the PCB components alone. The necessary creepage and clearance paths must be observed in connection with the respective applicant in accordance to IEC 664 / VDE 0110. The current-carrying capacity and pitch tolerance is to be determined according to DIN IEC 326 part 3 very fine. Weidmüller PCB components are tested to the DIN EN 61984 standard, and are valid for its field of application. Provided that the components are used to the intended purpose, all requirements with respect to the occurring of electrical, mechanical, thermic and corrosive stress will be satisfied.

Recommended wave soldering profiles

Weidmüller Interface GmbH & Co. KG
 Klängenbergstraße 16
 D-32758 Detmold
 Germany
 Fon: +49 5231 14-0
 Fax: +49 5231 14-292083
 www.weidmueller.com

Single Wave:



Double Wave:



Wave soldering profiles

Wired connection elements should be processed in accordance with the DIN EN 61760-1 standard. We have included two recommendations for practical wave soldering profiles, with which Weidmüller PCB terminals and connectors are qualified.

When choosing a suitable profile for your application, the following factors also need to be considered:

- PCB thickness
- Proportion of Cu in the layers
- Single/double-sided assembly
- Product range
- Heating and cooling rates

The single and double wave profiles each indicate the recommended operating range, including the maximum soldering temperature of 260°C. In practice, the maximum soldering temperature is quite often well below the above maximum profile.