

OMNIMATE Signal - series BL/SL 3.50 BLZF 3.50/11/180 SN BK BX

Weidmüller Interface GmbH & Co. KG
Klingenbergstraße 26
D-32758 Detmold
Germany
Fon: +49 5231 14-0
Fax: +49 5231 14-292083
www.weidmueller.com

Product image

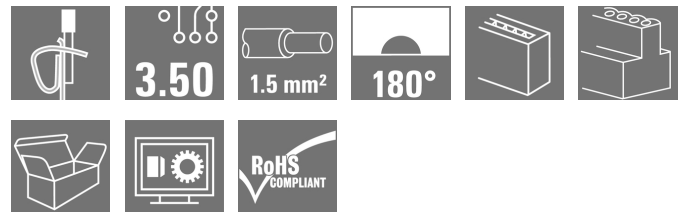

Similar to illustration

Female connectors with tension clamp system for connecting cables in 3.50 pitch. They provide space for labelling and can be coded.

General ordering data

Type	BLZF 3.50/11/180 SN BK BX
Order No.	1690510000
Version	PCB plug-in connector, female plug, 3.50 mm, Number of poles: 11, 180°, Tension-clamp connection, Clamping range, max. : 1.5 mm², Box
GTIN (EAN)	4008190329020
Qty.	50 pc(s).
Product data	IEC: 320 V / 14.5 A / 0.2 - 1.5 mm² UL: 300 V / 10 A / AWG 26 - AWG 14
Packaging	Box

Creation date May 3, 2020 1:40:31 PM CEST

**OMNIMATE Signal - series BL/SL 3.50
BLZF 3.50/11/180 SN BK BX**

Weidmüller Interface GmbH & Co. KG
 Klingenbergstraße 26
 D-32758 Detmold
 Germany
 Fon: +49 5231 14-0
 Fax: +49 5231 14-292083
 www.weidmueller.com

Technical data**Dimensions and weights**

Width	38.5 mm	Width (inches)	1.516 inch
Height	13 mm	Height (inches)	0.512 inch
Depth	22 mm	Depth (inches)	0.866 inch
Net weight	11.06 g		

System Parameters

Product family	OMNIMATE Signal - series BL/SL 3.50	Type of connection	Field connection
Wire connection method	Tension-clamp connection	Pitch in mm (P)	3.5 mm
Pitch in inches (P)	0.138 inch	Conductor outlet direction	180°
Number of poles	11	L1 in mm	35 mm
L1 in inches	1.378 inch	Number of rows	1
Pin series quantity	1	Rated cross-section	1.5 mm ²
Touch-safe protection acc. to DIN VDE 57 106	Safe from finger touch	Touch-safe protection acc. to DIN VDE 0470	IP 20
Volume resistance	≤ 5 mΩ	Can be coded	Yes
Stripping length	10 mm	Screwdriver blade	0.4 x 2.5
Screwdriver blade standard	DIN 5264-A	Plugging cycles	25
Plugging force/pole, max.	7 N	Pulling force/pole, max.	5 N

Material data

Insulating material	PBT	Colour	black
Colour chart (similar)	RAL 9011	Insulating material group	IIIa
Comparative Tracking Index (CTI)	≥ 200	Insulation strength	≥ 10 ⁸ Ω
UL 94 flammability rating	V-0	GWFI	960 °C
Contact material	Copper alloy	Contact surface	tinned
Layer structure of plug contact	4-8 μm Sn hot-dip tinned	Storage temperature, min.	-25 °C
Storage temperature, max.	50 °C	Max. relative humidity during storage	80 %
Operating temperature, min.	-50 °C	Operating temperature, max.	100 °C
Temperature range, installation, min.	-30 °C	Temperature range, installation, max.	100 °C

Conductors suitable for connection

Clamping range, min.	0.13 mm ²
Clamping range, max.	1.5 mm ²
Wire connection cross section AWG, min.	AWG 28
Wire connection cross section AWG, max.	AWG 16
Solid, min. H05(07) V-U	0.2 mm ²
Solid, max. H05(07) V-U	1.5 mm ²
Flexible, min. H05(07) V-K	0.2 mm ²
Flexible, max. H05(07) V-K	1.5 mm ²
w. plastic collar ferrule, DIN 46228 pt 4, 0.2 mm ² min.	
w. plastic collar ferrule, DIN 46228 pt 4, 1 mm ² max.	
w. wire end ferrule, DIN 46228 pt 1, min.	0.2 mm ²
w. wire end ferrule, DIN 46228 pt 1, max.	1.5 mm ²
Outer diameter of insulation, max.	2.9 mm
Plug gauge in accordance with EN 60999 a x b; ø	2.4 mm x 1.5 mm

Creation date May 3, 2020 1:40:31 PM CEST

OMNIMATE Signal - series BL/SL 3.50
BLZF 3.50/11/180 SN BK BX

Weidmüller Interface GmbH & Co. KG
 Klingenbergstraße 26
 D-32758 Detmold
 Germany
 Fon: +49 5231 14-0
 Fax: +49 5231 14-292083
 www.weidmueller.com

Technical data

Clampable conductor	Cross-section for conductor connection	Type	fine-wired	
		nominal	0.5 mm ²	
	wire end ferrule	Stripping length	nominal	12 mm
		Recommended wire-end ferrule	H0.5/16 OR	
		Stripping length	nominal	10 mm
		Recommended wire-end ferrule	H0.5/10	
	Cross-section for conductor connection	Type	fine-wired	
		nominal	0.75 mm ²	
	wire end ferrule	Stripping length	nominal	12 mm
		Recommended wire-end ferrule	H0.75/16 W	
		Stripping length	nominal	10 mm
		Recommended wire-end ferrule	H0.75/10	
	Cross-section for conductor connection	Type	fine-wired	
		nominal	1 mm ²	
	wire end ferrule	Stripping length	nominal	12 mm
		Recommended wire-end ferrule	H1.0/16D R	
Stripping length		nominal	10 mm	
Recommended wire-end ferrule		H1.0/10		
Cross-section for conductor connection	Type	fine-wired		
	nominal	1.5 mm ²		
wire end ferrule	Stripping length	nominal	10 mm	
	Recommended wire-end ferrule	H1.5/10		

Reference text The outside diameter of the plastic collar should not be larger than the pitch (P), Length of ferrules is to be chosen depending on the product and the rated voltage.

Max. clamping range 1.5 mm²

Rated data acc. to IEC

tested acc. to standard	IEC 60664-1, IEC 61984	Rated current, min. number of poles (Tu=20°C)	14.5 A
Rated current, max. number of poles (Tu=20°C)	10 A	Rated current, min. number of poles (Tu=40°C)	12 A
Rated current, max. number of poles (Tu=40°C)	8 A	Rated voltage for surge voltage class / pollution degree II/2	320 V
Rated voltage for surge voltage class / pollution degree III/2	160 V	Rated voltage for surge voltage class / pollution degree III/3	160 V
Rated impulse voltage for surge voltage class/ pollution degree II/2	2.5 kV	Rated impulse voltage for surge voltage class/ pollution degree III/2	2.5 kV
Rated impulse voltage for surge voltage class/ contamination degree III/3	2.5 kV	Short-time withstand current resistance	3 x 1s with 100 A

Data sheet

**OMNIMATE Signal - series BL/SL 3.50
BLZF 3.50/11/180 SN BK BX**

Weidmüller Interface GmbH & Co. KG
Klingenbergstraße 26
D-32758 Detmold
Germany
Fon: +49 5231 14-0
Fax: +49 5231 14-292083
www.weidmueller.com

Technical data

Rated data acc. to CSA

Institute (CSA)				Certificate No. (CSA)	
				200039-1461395	
Rated voltage (Use group B / CSA)	300 V	Rated voltage (Use group D / CSA)	300 V		
Rated current (Use group B / CSA)	10 A	Rated current (Use group D / CSA)	10 A		
Wire cross-section, AWG, min.	AWG 26	Wire cross-section, AWG, max.	AWG 14		
Reference to approval values	Specifications are maximum values, details - see approval certificate.				

Rated data acc. to UL 1059

Institute (UR)				Certificate No. (UR)	
				E60693	
Rated voltage (Use group B / UL 1059)	300 V	Rated voltage (Use group D / UL 1059)	300 V		
Rated current (Use group B / UL 1059)	10 A	Rated current (Use group D / UL 1059)	10 A		
Wire cross-section, AWG, min.	AWG 26	Wire cross-section, AWG, max.	AWG 14		
Reference to approval values	Specifications are maximum values, details - see approval certificate.				

Packing

Packaging	Box	VPE length	63 mm
VPE width	113 mm	VPE height	144 mm

Classifications

ETIM 6.0	EC002638	ETIM 7.0	EC002638
eClass 9.0	27-44-03-09	eClass 9.1	27-44-03-09
eClass 10.0	27-44-03-09	UNSPSC	30-21-18-10

OMNIMATE Signal - series BL/SL 3.50 BLZF 3.50/11/180 SN BK BX

Weidmüller Interface GmbH & Co. KG
Klingenbergstraße 26
D-32758 Detmold
Germany
Fon: +49 5231 14-0
Fax: +49 5231 14-292083
www.weidmueller.com

Technical data

Notes

Notes	<ul style="list-style-type: none"> • Additional colours on request • Gold-plated contact surfaces on request • Rated current related to rated cross-section & min. No. of poles. • Max. outer diameter of the conductor: 2.9 mm • Wire end ferrule without plastic collar to DIN 46228/1 • Wire end ferrule with plastic collar to DIN 46228/4 • Crimp shape A for wire-end ferrules with crimping tools PZ 1,5 (order no. 9005990000) or PZ 6/5 (order no. 9011460000) for larger wire cross-sections recommended. • P on drawing = pitch • Rated data refer only to the component itself. Clearance and creepage distances to other components are to be designed in accordance with the relevant application standards.
-------	---

IPC conformity	Conformity: The products are developed, manufactured and delivered according international recognized standards and norms and comply with the assured properties in the data sheet resp. fulfill decorative properties in accordance with IPC-A-610 "Class 2". Further claims on the products can be evaluated on request.
----------------	--

Approvals

Approvals



ROHS	Conform
------	---------

Downloads

Approval/Certificate/Document of Conformity	Declaration of the Manufacturer
Brochure/Catalogue	FL DRIVES EN MB DEVICE MANUF. EN FL DRIVES DE CAT 2 PORTFOLIOGUIDE EN FL BUILDING SAFETY EN FL APPL LED LIGHTING EN FLIndustr.CONTROLS EN FL MACHINE SAFETY EN FL HEATING ELECTR EN FL APPL INVERTER EN FL_BASE_STATION_EN FL ELEVATOR EN FL POWER SUPPLY EN FL 72H SAMPLE SER EN PO OMNIMATE EN
Engineering Data	EPLAN_WSCAD
Engineering Data	STEP

Creation date May 3, 2020 1:40:31 PM CEST

Catalogue status 17.04.2020 / We reserve the right to make technical changes.

Data sheet

**OMNIMATE Signal - series BL/SL 3.50
BLZF 3.50/11/180 SN BK BX**

Weidmüller Interface GmbH & Co. KG
Klingenbergstraße 26
D-32758 Detmold
Germany
Fon: +49 5231 14-0
Fax: +49 5231 14-292083
www.weidmueller.com

Drawings

Dimensional drawing

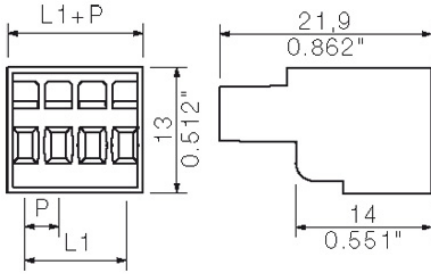

Graph

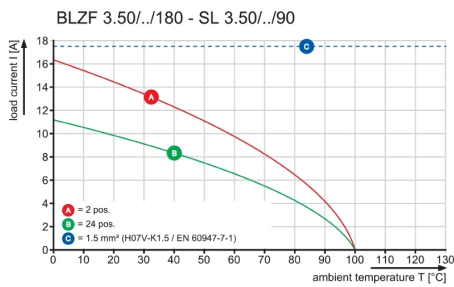

Graph

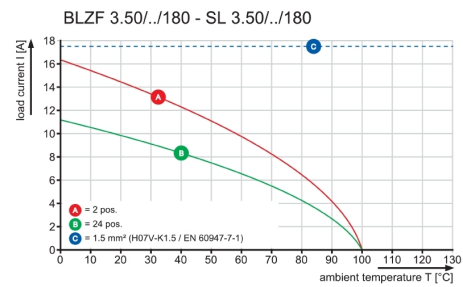

Graph

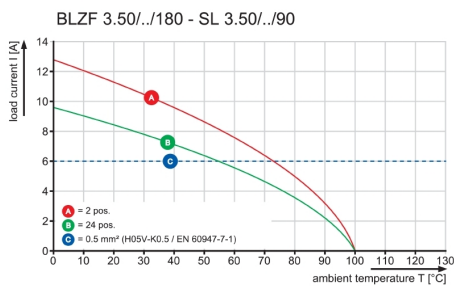

**OMNIMATE Signal - series BL/SL 3.50
BLZF 3.50/11/180 SN BK BX**

Weidmüller Interface GmbH & Co. KG
Klingenbergstraße 26
D-32758 Detmold
Germany
Fon: +49 5231 14-0
Fax: +49 5231 14-292083
www.weidmueller.com

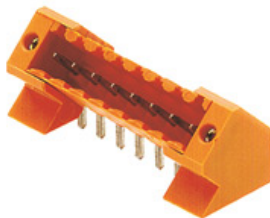
Mating connector (conditionally pluggable)
SL 3.50/135F

Pin headers for wave soldering in 3.50 mm pitch

- Plugging direction is parallel (90°), straight 180° or angled (135°) to the PCB
- Housing variant: screw flange (F)
- Packed in a cardboard box (BX)
- Pin header can be coded

General ordering data

Type	SL 3.50/11/135F 3.2SN O ...	Version	Product data	Packaging
Order No.	1643420000	PCB plug-in connector, male header, Flange, THT solder connection,	IEC: 320 V / 15 A	Box
GTIN (EAN)	4008190282189	3.50 mm, Number of poles: 11, 135°, Solder pin length (l): 3.2 mm,	UL: 300 V / 10 A	
Qty.	36 pc(s).	tinned, orange, Box		

SL-SMT 3.5/90LF Box

High-temperature-resistant male header, 3.50 mm pitch.

- **Plugging direction parallel (90°), straight 180° or angled (135°) to PCB**
- **Housing variants: closed side (G), screw flange (F), solder flange (LF) or snap-on solder flange (RF)**
- **Optimised for the SMT process**
- **Pin length 3.2 mm universal for all soldering methods**
- **Pin length 1.5 mm optimised for reflow soldering methods**
- **Packed either in a box (BX) or tape-on-reel (RL)**
- **Male header can be coded**

General ordering data

Type	SL-SMT 3.50/11/90LF 1.5 ...	Version	Product data	Packaging
Order No.	1805030000	PCB plug-in connector, male header, Solder flange, THT/THR solder	IEC: 320 V / 15 A	Box
GTIN (EAN)	4032248268931	connection, 3.50 mm, Number of poles: 11, 90°, Solder pin length (l):	UL: 300 V / 10 A	
Qty.	50 pc(s).	1.5 mm, tinned, black, Box		
Type	SL-SMT 3.50/11/90LF 3.2 ...	Version	Product data	Packaging
Order No.	1841950000	PCB plug-in connector, male header, Solder flange, THT/THR solder	IEC: 320 V / 15 A	Box
GTIN (EAN)	4032248353309	connection, 3.50 mm, Number of poles: 11, 90°, Solder pin length (l):	UL: 300 V / 10 A	
Qty.	36 pc(s).	3.2 mm, tinned, black, Box		

**OMNIMATE Signal - series BL/SL 3.50
BLZF 3.50/11/180 SN BK BX**

Weidmüller Interface GmbH & Co. KG
Klingenbergstraße 26
D-32758 Detmold
Germany
Fon: +49 5231 14-0
Fax: +49 5231 14-292083
www.weidmueller.com

Mating connector (conditionally pluggable)
SL-SMT 3.5/180F Box

High-temperature-resistant male header, 3.50 mm pitch.

- **Plugging direction parallel (90°), straight 180° or angled (135°) to PCB**
- **Housing variants: closed side (G), screw flange (F), solder flange (LF) or snap-on solder flange (RF)**
- **Optimised for the SMT process**
- **Pin length 3.2 mm universal for all soldering methods**
- **Pin length 1.5 mm optimised for reflow soldering methods**
- **Packed either in a box (BX) or tape-on-reel (RL)**
- **Male header can be coded**

General ordering data

Type	SL-SMT 3.50/11/180F 3.2 ...	Version	Product data	Packaging
Order No.	1842860000	PCB plug-in connector, male header, Flange, THT/THR solder connection, 3.50 mm, Number of poles: 11, 180°, Solder pin length (l): 3.2 mm, tinned, black, Box	IEC: 320 V / 15 A UL: 300 V / 10 A	Box
GTIN (EAN)	4032248354320			
Qty.	36 pc(s).			

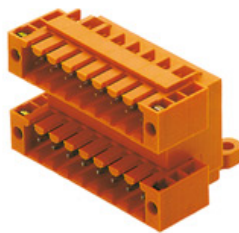
SLD 3.50/90F

Two-tier pin header for wave soldering in 3.50 mm pitch. The connector is available in open, closed and flange versions. The male connectors provide space for labelling and can be coded. Packed in a cardboard box.

General ordering data

Type	SLD 3.50/22/90F 3.2SN O ...	Version	Product data	Packaging
Order No.	1633900000	PCB plug-in connector, male header, Flange, THT solder connection, 3.50 mm, Number of poles: 22, 90°, Solder pin length (l): 3.2 mm, tinned, orange, Box	IEC: 200 V / 10.5 A UL: 300 V / 8 A	Box
GTIN (EAN)	4008190258351			
Qty.	10 pc(s).			

**OMNIMATE Signal - series BL/SL 3.50
BLZF 3.50/11/180 SN BK BX**

Weidmüller Interface GmbH & Co. KG
Klingenbergstraße 26
D-32758 Detmold
Germany
Fon: +49 5231 14-0
Fax: +49 5231 14-292083
www.weidmueller.com

Mating connector (conditionally pluggable)
SLD 3.50V/90F

Double-level, staggered pin header for wave soldering at 3.50 mm pitch. They are available in closed and flanged versions. The male connectors provide space for labelling and can be coded.

General ordering data

Type	SLD 3.50V/22/90F 3.2SN ...	Version	Product data	Packaging
Order No.	1669660000	PCB plug-in connector, male header, Flange, THT solder connection,	IEC: 200 V / 10.5 A	Box
GTIN (EAN)	4008190429249	3.50 mm, Number of poles: 22, 90°, Solder pin length (l): 3.2 mm,	UL: 300 V / 8 A	
Qty.	10 pc(s).	tinned, orange, Box		

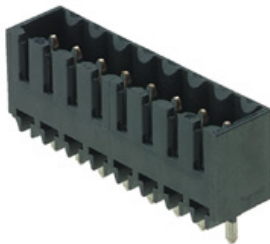
SL-SMT 3.5/180G Box

High-temperature-resistant male header, 3.50 mm pitch.

- **Plugging direction parallel (90°), straight 180° or angled (135°) to PCB**
- **Housing variants: closed side (G), screw flange (F), solder flange (LF) or snap-on solder flange (RF)**
- **Optimised for the SMT process**
- **Pin length 3.2 mm universal for all soldering methods**
- **Pin length 1.5 mm optimised for reflow soldering methods**
- **Packed either in a box (BX) or tape-on-reel (RL)**
- **Male header can be coded**

General ordering data

Type	SL-SMT 3.50/11/180G 1.5 ...	Version	Product data	Packaging
Order No.	1753072001	PCB plug-in connector, male header, closed side, THT/THR solder	IEC: 320 V / 15 A	Box
GTIN (EAN)	4032248130979	connection, 3.50 mm, Number of poles: 11, 180°, Solder pin length	UL: 300 V / 10 A	
Qty.	50 pc(s).	(l): 1.5 mm, tinned, black, Box		
Type	SL-SMT 3.50/11/180G 3.2 ...	Version	Product data	Packaging
Order No.	1842400000	PCB plug-in connector, male header, closed side, THT/THR solder	IEC: 320 V / 15 A	Box
GTIN (EAN)	4032248353750	connection, 3.50 mm, Number of poles: 11, 180°, Solder pin length	UL: 300 V / 10 A	
Qty.	50 pc(s).	(l): 3.2 mm, tinned, black, Box		

**OMNIMATE Signal - series BL/SL 3.50
BLZF 3.50/11/180 SN BK BX**

Weidmüller Interface GmbH & Co. KG
Klingenbergstraße 26
D-32758 Detmold
Germany
Fon: +49 5231 14-0
Fax: +49 5231 14-292083
www.weidmueller.com

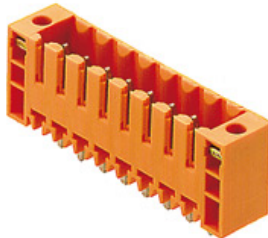
Mating connector (conditionally pluggable)
SL 3.50/180F

Pin headers for wave soldering in 3.50 mm pitch

- Plugging direction is parallel (90°), straight 180° or angled (135°) to the PCB
- Housing variant: screw flange (F)
- Packed in a cardboard box (BX)
- Pin header can be coded

General ordering data

Type	SL 3.50/11/180F 4.5SN B ...	Version	Product data	Packaging
Order No.	1616220000	PCB plug-in connector, male header, Flange, THT solder connection,	IEC: 320 V / 17 A	Box
GTIN (EAN)	4008190069179	3.50 mm, Number of poles: 11, 180°, Solder pin length (l): 4.5 mm,	UL: 300 V / 10 A	
Qty.	50 pc(s).	tinned, black, Box		
Type	SL 3.50/11/180F 4.5SN O ...	Version	Product data	Packaging
Order No.	1618770000	PCB plug-in connector, male header, Flange, THT solder connection,	IEC: 320 V / 17 A	Box
GTIN (EAN)	4008190127480	3.50 mm, Number of poles: 11, 180°, Solder pin length (l): 4.5 mm,	UL: 300 V / 10 A	
Qty.	50 pc(s).	tinned, orange, Box		
Type	SL 3.50/11/180F 3.2SN D ...	Version	Product data	Packaging
Order No.	1622570000	PCB plug-in connector, male header, Flange, THT solder connection,	IEC: 320 V / 17 A	Box
GTIN (EAN)	4008190193232	3.50 mm, Number of poles: 11, 180°, Solder pin length (l): 3.2 mm,	UL: 300 V / 10 A	
Qty.	50 pc(s).	tinned, Signal green, Box		
Type	SL 3.50/11/180F 3.2SN G ...	Version	Product data	Packaging
Order No.	1622350000	PCB plug-in connector, male header, Flange, THT solder connection,	IEC: 320 V / 17 A	Box
GTIN (EAN)	4008190190057	3.50 mm, Number of poles: 11, 180°, Solder pin length (l): 3.2 mm,	UL: 300 V / 10 A	
Qty.	50 pc(s).	tinned, Pebble grey, Box		
Type	SL 3.50/11/180F 3.2SN O ...	Version	Product data	Packaging
Order No.	1607590000	PCB plug-in connector, male header, Flange, THT solder connection,	IEC: 320 V / 17 A	Box
GTIN (EAN)	4008190125509	3.50 mm, Number of poles: 11, 180°, Solder pin length (l): 3.2 mm,	UL: 300 V / 10 A	
Qty.	50 pc(s).	tinned, orange, Box		

OMNIMATE Signal - series BL/SL 3.50 BLZF 3.50/11/180 SN BK BX

Weidmüller Interface GmbH & Co. KG
Klingenbergstraße 26
D-32758 Detmold
Germany
Fon: +49 5231 14-0
Fax: +49 5231 14-292083
www.weidmueller.com

Mating connector (conditionally pluggable)

SL-SMT 3.5/90F Box



High-temperature-resistant male header, 3.50 mm pitch.

- **Plugging direction parallel (90°), straight 180° or angled (135°) to PCB**
- **Housing variants: closed side (G), screw flange (F), solder flange (LF) or snap-on solder flange (RF)**
- **Optimised for the SMT process**
- **Pin length 3.2 mm universal for all soldering methods**
- **Pin length 1.5 mm optimised for reflow soldering methods**
- **Packed either in a box (BX) or tape-on-reel (RL)**
- **Male header can be coded**

General ordering data

Type	SL-SMT 3.50/11/90F 3.2S ...	Version	Product data	Packaging
Order No.	1842170000	PCB plug-in connector, male header, Flange, THT/THR solder connection, 3.50 mm, Number of poles: 11, 90°, Solder pin length (l): 3.2 mm, tinned, black, Box	IEC: 320 V / 15 A UL: 300 V / 10 A	Box
GTIN (EAN)	4032248353521			
Qty.	36 pc(s).			

SL 3.50/90F

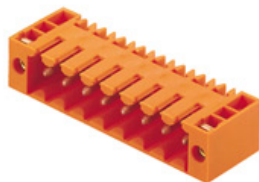

Pin headers for wave soldering in 3.50 mm pitch

- Plugging direction is parallel (90°), straight 180° or angled (135°) to the PCB
- Housing variant: screw flange (F)
- Packed in a cardboard box (BX)
- Pin header can be coded

General ordering data

Type	SL 3.50/11/90F 3.2SN DK ...	Version	Product data	Packaging
Order No.	1620150000	PCB plug-in connector, male header, Flange, THT solder connection, 3.50 mm, Number of poles: 11, 90°, Solder pin length (l): 3.2 mm, tinned, Signal green, Box	IEC: / 17 A UL: 300 V / 10 A	Box
GTIN (EAN)	4008190152567			
Qty.	50 pc(s).			
Type	SL 3.50/11/90F 3.2SN BK ...	Version	Product data	Packaging
Order No.	1693990000	PCB plug-in connector, male header, Flange, THT solder connection, 3.50 mm, Number of poles: 11, 90°, Solder pin length (l): 3.2 mm, tinned, black, Box	IEC: / 17 A UL: 300 V / 10 A	Box
GTIN (EAN)	4008190871918			
Qty.	50 pc(s).			
Type	SL 3.50/11/90F 3.2SN GY ...	Version	Product data	Packaging
Order No.	1619940000	PCB plug-in connector, male header, Flange, THT solder connection, 3.50 mm, Number of poles: 11, 90°, Solder pin length (l): 3.2 mm, tinned, Pebble grey, Box	IEC: / 17 A UL: 300 V / 10 A	Box
GTIN (EAN)	4008190149239			
Qty.	50 pc(s).			

OMNIMATE Signal - series BL/SL 3.50 BLZF 3.50/11/180 SN BK BX

Weidmüller Interface GmbH & Co. KG
 Klingenbergstraße 26
 D-32758 Detmold
 Germany
 Fon: +49 5231 14-0
 Fax: +49 5231 14-292083
 www.weidmueller.com

Mating connector (conditionally pluggable)

Type	SL 3.50/11/90F 4.5SN OR ...	Version	Product data	Packaging
Order No.	1618140000	PCB plug-in connector, male header, Flange, THT solder connection,	IEC: / 17 A	Box
GTIN (EAN)	4008190117030	3.50 mm, Number of poles: 11, 90°, Solder pin length (l): 4.5 mm,	UL: 300 V / 10 A	
Qty.	50 pc(s).	tinned, orange, Box		
Type	SL 3.50/11/90F 4.5SN BK ...	Version	Product data	Packaging
Order No.	1615610000	PCB plug-in connector, male header, Flange, THT solder connection,	IEC: / 17 A	Box
GTIN (EAN)	4008190057879	3.50 mm, Number of poles: 11, 90°, Solder pin length (l): 4.5 mm,	UL: 300 V / 10 A	
Qty.	50 pc(s).	tinned, black, Box		
Type	SL 3.50/11/90F 3.2SN OR ...	Version	Product data	Packaging
Order No.	1607130000	PCB plug-in connector, male header, Flange, THT solder connection,	IEC: / 17 A	Box
GTIN (EAN)	4008190009502	3.50 mm, Number of poles: 11, 90°, Solder pin length (l): 3.2 mm,	UL: 300 V / 10 A	
Qty.	50 pc(s).	tinned, orange, Box		

SL-SMT 3.5/180LF Box



High-temperature-resistant male header, 3.50 mm pitch.

- **Plugging direction parallel (90°), straight 180° or angled (135°) to PCB**
- **Housing variants: closed side (G), screw flange (F), solder flange (LF) or snap-on solder flange (RF)**
- **Optimised for the SMT process**
- **Pin length 3.2 mm universal for all soldering methods**
- **Pin length 1.5 mm optimised for reflow soldering methods**
- **Packed either in a box (BX) or tape-on-reel (RL)**
- **Male header can be coded**

General ordering data

Type	SL-SMT 3.50/11/180LF 3. ...	Version	Product data	Packaging
Order No.	1842630000	PCB plug-in connector, male header, Solder flange, THT/THR solder	IEC: 320 V / 15 A	Box
GTIN (EAN)	4032248353996	connection, 3.50 mm, Number of poles: 11, 180°, Solder pin length	UL: 300 V / 10 A	
Qty.	36 pc(s).	(l): 3.2 mm, tinned, black, Box		
Type	SL-SMT 3.50/11/180LF 1. ...	Version	Product data	Packaging
Order No.	1804790000	PCB plug-in connector, male header, Solder flange, THT/THR solder	IEC: 320 V / 15 A	Box
GTIN (EAN)	4032248268573	connection, 3.50 mm, Number of poles: 11, 180°, Solder pin length	UL: 300 V / 10 A	
Qty.	50 pc(s).	(l): 1.5 mm, tinned, black, Box		

**OMNIMATE Signal - series BL/SL 3.50
BLZF 3.50/11/180 SN BK BX**

Weidmüller Interface GmbH & Co. KG
Klingenbergstraße 26
D-32758 Detmold
Germany
Fon: +49 5231 14-0
Fax: +49 5231 14-292083
www.weidmuller.com

Mating connector (fully pluggable)
SL-SMT 3.5/90G Tray

High-temperature-resistant male header, 3.50 mm pitch.

- **Plugging direction parallel (90°), straight 180° or angled (135°) to PCB**
- **Housing variants: closed side (G), screw flange (F), solder flange (LF) or snap-on solder flange (RF)**
- **Optimised for the SMT process**
- **Pin length 3.2 mm universal for all soldering methods**
- **Pin length 1.5 mm optimised for reflow soldering methods**
- **Packed either in a box (BX) or tape-on-reel (RL)**
- **Male header can be coded**

General ordering data

Type	SL-SMT 3.50/11/90G 1.5S ...	Version	Product data	Packaging
Order No.	1761633001	PCB plug-in connector, male header, closed side, THT/THR solder connection, 3.50 mm, Number of poles: 11, 90°, Solder pin length (l): 1.5 mm, tinned, black, Tray	IEC: 320 V / 15 A	Tray
GTIN (EAN)	4032248133901		UL: 300 V / 10 A	
Qty.	36 pc(s).			

SL-SMT 3.5/90G Tape

High-temperature-resistant male header, 3.50 mm pitch.

- **Plugging direction parallel (90°), straight 180° or angled (135°) to PCB**
- **Housing variants: closed side (G), screw flange (F), solder flange (LF) or snap-on solder flange (RF)**
- **Optimised for the SMT process**
- **Pin length 3.2 mm universal for all soldering methods**
- **Pin length 1.5 mm optimised for reflow soldering methods**
- **Packed either in a box (BX) or tape-on-reel (RL)**
- **Male header can be coded**

General ordering data

Type	SL-SMT 3.50/11/90G 1.5S ...	Version	Product data	Packaging
Order No.	1761634001	PCB plug-in connector, male header, closed side, THT/THR solder connection, 3.50 mm, Number of poles: 11, 90°, Solder pin length (l): 1.5 mm, tinned, black, Tape	IEC: 320 V / 15 A	Tape
GTIN (EAN)	4032248136070		UL: 300 V / 10 A	
Qty.	385 pc(s).			

**OMNIMATE Signal - series BL/SL 3.50
BLZF 3.50/11/180 SN BK BX**

Weidmüller Interface GmbH & Co. KG
Klingenbergstraße 26
D-32758 Detmold
Germany
Fon: +49 5231 14-0
Fax: +49 5231 14-292083
www.weidmueller.com

Mating connector (fully pluggable)
SL-THR 3.5/135F

High-temperature-resistant male header, 3.50 mm pitch.

- **Plugging direction parallel (90°), straight 180° or angled (135°) to PCB**
- **Housing variants: closed side (G), screw flange (F), solder flange (LF) or snap-on solder flange (RF)**
- **Optimised for the SMT process**
- **Pin length 3.2 mm universal for all soldering methods**
- **Pin length 1.5 mm optimised for reflow soldering methods**
- **Packed either in a box (BX) or tape-on-reel (RL)**
- **Male header can be coded**

General ordering data

Type	SL-SMT 3.50/11/135F 3.2 ...	Version	Product data	Packaging
Order No.	1003600000	PCB plug-in connector, male header, Flange, THT/THR solder connection, 3.50 mm, Number of poles: 11, 135°, Solder pin length (l): 3.2 mm, tinned, black, Box	IEC: 320 V / 15 A UL: 300 V / 10 A	Box
GTIN (EAN)	4032248700233			
Qty.	36 pc(s).			

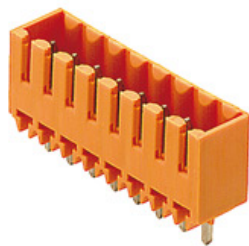
SL 3.50/180G

Pin headers for wave soldering in 3.50 mm pitch

- **Plugging direction is parallel (90°), straight 180° or angled (135°) to the PCB**
- **Housing variant: screw flange (F)**
- **Packed in a cardboard box (BX)**
- **Pin header can be coded**

General ordering data

Type	SL 3.50/11/180G 3.2SN O ...	Version	Product data	Packaging
Order No.	1604560000	PCB plug-in connector, male header, closed side, THT solder connection, 3.50 mm, Number of poles: 11, 180°, Solder pin length (l): 3.2 mm, tinned, orange, Box	IEC: 320 V / 17 A UL: 300 V / 10 A	Box
GTIN (EAN)	4008190030568			
Qty.	50 pc(s).			

**OMNIMATE Signal - series BL/SL 3.50
BLZF 3.50/11/180 SN BK BX**

Weidmüller Interface GmbH & Co. KG
Klingenbergstraße 26
D-32758 Detmold
Germany
Fon: +49 5231 14-0
Fax: +49 5231 14-292083
www.weidmueller.com

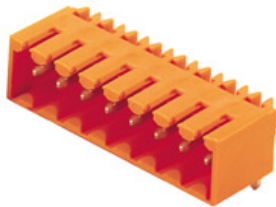
Mating connector (fully pluggable)
SL 3.50/90G

Pin headers for wave soldering in 3.50 mm pitch

- Plugging direction is parallel (90°), straight 180° or angled (135°) to the PCB
- Housing variant: screw flange (F)
- Packed in a cardboard box (BX)
- Pin header can be coded

General ordering data

Type	SL 3.50/11/90G 3.2SN GY ...	Version	Product data	Packaging
Order No.	1619550000	PCB plug-in connector, male header, closed side, THT solder	IEC: / 17 A	Box
GTIN (EAN)	4008190142261	connection, 3.50 mm, Number of poles: 11, 90°, Solder pin length (l):	UL: 300 V / 10 A	
Qty.	50 pc(s).	3.2 mm, tinned, Pebble grey, Box		
Type	SL 3.50/11/90G 3.2SN DK ...	Version	Product data	Packaging
Order No.	1606980000	PCB plug-in connector, male header, closed side, THT solder	IEC: / 17 A	Box
GTIN (EAN)	4008190029579	connection, 3.50 mm, Number of poles: 11, 90°, Solder pin length (l):	UL: 300 V / 10 A	
Qty.	50 pc(s).	3.2 mm, tinned, Signal green, Box		
Type	SL 3.50/11/90G 4.5SN BK ...	Version	Product data	Packaging
Order No.	1615480000	PCB plug-in connector, male header, closed side, THT solder	IEC: / 17 A	Box
GTIN (EAN)	4008190055882	connection, 3.50 mm, Number of poles: 11, 90°, Solder pin length (l):	UL: 300 V / 10 A	
Qty.	50 pc(s).	4.5 mm, tinned, black, Box		
Type	SL 3.50/11/90G 3.2SN OR ...	Version	Product data	Packaging
Order No.	1605160000	PCB plug-in connector, male header, closed side, THT solder	IEC: / 17 A	Box
GTIN (EAN)	4008190003982	connection, 3.50 mm, Number of poles: 11, 90°, Solder pin length (l):	UL: 300 V / 10 A	
Qty.	50 pc(s).	3.2 mm, tinned, orange, Box		
Type	SL 3.50/11/90G 4.5SN OR ...	Version	Product data	Packaging
Order No.	1605310000	PCB plug-in connector, male header, closed side, THT solder	IEC: / 17 A	Box
GTIN (EAN)	4008190090289	connection, 3.50 mm, Number of poles: 11, 90°, Solder pin length (l):	UL: 300 V / 10 A	
Qty.	50 pc(s).	4.5 mm, tinned, orange, Box		
Type	SL 3.50/11/90G 3.2SN BK ...	Version	Product data	Packaging
Order No.	1766980000	PCB plug-in connector, male header, closed side, THT solder	IEC: / 17 A	Box
GTIN (EAN)	4032248341719	connection, 3.50 mm, Number of poles: 11, 90°, Solder pin length (l):	UL: 300 V / 10 A	
Qty.	50 pc(s).	3.2 mm, tinned, black, Box		

**OMNIMATE Signal - series BL/SL 3.50
BLZF 3.50/11/180 SN BK BX**

Weidmüller Interface GmbH & Co. KG
Klingenbergstraße 26
D-32758 Detmold
Germany
Fon: +49 5231 14-0
Fax: +49 5231 14-292083
www.weidmueller.com

Mating connector (fully pluggable)
SLD 3.50V/90G

Double-level, staggered pin header for wave soldering at 3.50 mm pitch. They are available in closed and flanged versions. The male connectors provide space for labelling and can be coded.

General ordering data

Type	SLD 3.50V/22/90G 3.2SN ...	Version	Product data	Packaging
Order No.	1669650000	PCB plug-in connector, male header, closed side, THT solder	IEC: 200 V / 10.5 A	Box
GTIN (EAN)	4008190429232	connection, 3.50 mm, Number of poles: 22, 90°, Solder pin length (l):	UL: 300 V / 8 A	
Qty.	10 pc(s).	3.2 mm, tinned, orange, Box		

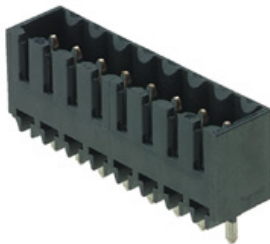
SL-SMT 3.5/180G Tape

High-temperature-resistant male header, 3.50 mm pitch.

- **Plugging direction parallel (90°), straight 180° or angled (135°) to PCB**
- **Housing variants: closed side (G), screw flange (F), solder flange (LF) or snap-on solder flange (RF)**
- **Optimised for the SMT process**
- **Pin length 3.2 mm universal for all soldering methods**
- **Pin length 1.5 mm optimised for reflow soldering methods**
- **Packed either in a box (BX) or tape-on-reel (RL)**
- **Male header can be coded**

General ordering data

Type	SL-SMT 3.50/11/180G 1.5 ...	Version	Product data	Packaging
Order No.	1753074001	PCB plug-in connector, male header, closed side, THT/THR solder	IEC: 320 V / 15 A	Tape
GTIN (EAN)	4032248135677	connection, 3.50 mm, Number of poles: 11, 180°, Solder pin length	UL: 300 V / 10 A	
Qty.	265 pc(s).	(l): 1.5 mm, tinned, black, Tape		

OMNIMATE Signal - series BL/SL 3.50 BLZF 3.50/11/180 SN BK BX

Weidmüller Interface GmbH & Co. KG
Klingenbergstraße 26
D-32758 Detmold
Germany
Fon: +49 5231 14-0
Fax: +49 5231 14-292083
www.weidmueller.com

Mating connector (fully pluggable)

SL 3.50/180

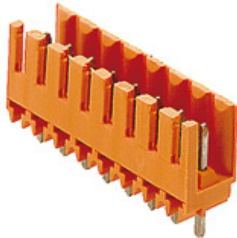

Pin headers for wave soldering in 3.50 mm pitch

- Plugging direction is parallel (90°), straight 180° or angled (135°) to the PCB
- Housing variant: screw flange (F)
- Packed in a cardboard box (BX)
- Pin header can be coded

General ordering data

Type	SL 3.50/11/180 3.2SN OR ...	Version	Product data	Packaging
Order No.	1604860000	PCB plug-in connector, male header, open side, THT solder	IEC: 320 V / 17 A	Box
GTIN (EAN)	4008190062507	connection, 3.50 mm, Number of poles: 11, 180°, Solder pin length	UL: 300 V / 10 A	
Qty.	50 pc(s).	(l): 3.2 mm, tinned, orange, Box		

SL-SMT 3.5/180G Tray



High-temperature-resistant male header, 3.50 mm pitch.

- **Plugging direction parallel (90°), straight 180° or angled (135°) to PCB**
- **Housing variants: closed side (G), screw flange (F), solder flange (LF) or snap-on solder flange (RF)**
- **Optimised for the SMT process**
- **Pin length 3.2 mm universal for all soldering methods**
- **Pin length 1.5 mm optimised for reflow soldering methods**
- **Packed either in a box (BX) or tape-on-reel (RL)**
- **Male header can be coded**

General ordering data

Type	SL-SMT 3.50/11/180G 1.5 ...	Version	Product data	Packaging
Order No.	1753073001	PCB plug-in connector, male header, closed side, THT/THR solder	IEC: 320 V / 15 A	Tray
GTIN (EAN)	4032248132805	connection, 3.50 mm, Number of poles: 11, 180°, Solder pin length	UL: 300 V / 10 A	
Qty.	36 pc(s).	(l): 1.5 mm, tinned, black, Tray		

OMNIMATE Signal - series BL/SL 3.50 BLZF 3.50/11/180 SN BK BX

Weidmüller Interface GmbH & Co. KG
Klingenbergstraße 26
D-32758 Detmold
Germany
Fon: +49 5231 14-0
Fax: +49 5231 14-292083
www.weidmueller.com

Mating connector (fully pluggable)

SL-SMT 3.5/90G Box



High-temperature-resistant male header, 3.50 mm pitch.

- **Plugging direction parallel (90°), straight 180° or angled (135°) to PCB**
- **Housing variants: closed side (G), screw flange (F), solder flange (LF) or snap-on solder flange (RF)**
- **Optimised for the SMT process**
- **Pin length 3.2 mm universal for all soldering methods**
- **Pin length 1.5 mm optimised for reflow soldering methods**
- **Packed either in a box (BX) or tape-on-reel (RL)**
- **Male header can be coded**

General ordering data

Type	SL-SMT 3.50/11/90G 3.2S ...	Version	Product data	Packaging
Order No.	1841720000	PCB plug-in connector, male header, closed side, THT/THR solder connection, 3.50 mm, Number of poles: 11, 90°, Solder pin length (l): 3.2 mm, tinned, black, Box	IEC: 320 V / 15 A UL: 300 V / 10 A	Box
GTIN (EAN)	4032248353071			
Qty.	50 pc(s).			
Type	SL-SMT 3.50/11/90G 1.5S ...	Version	Product data	Packaging
Order No.	1761632001	PCB plug-in connector, male header, closed side, THT/THR solder connection, 3.50 mm, Number of poles: 11, 90°, Solder pin length (l): 1.5 mm, tinned, black, Box	IEC: 320 V / 15 A UL: 300 V / 10 A	Box
GTIN (EAN)	4032248132225			
Qty.	50 pc(s).			

SL 3.50/90

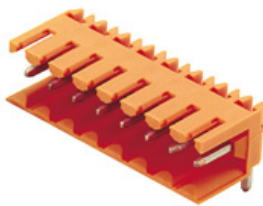

Pin headers for wave soldering in 3.50 mm pitch

- **Plugging direction is parallel (90°), straight 180° or angled (135°) to the PCB**
- **Housing variant: screw flange (F)**
- **Packed in a cardboard box (BX)**
- **Pin header can be coded**

General ordering data

Type	SL 3.50/11/90 3.2SN OR ...	Version	Product data	Packaging
Order No.	1597300000	PCB plug-in connector, male header, open side, THT solder connection, 3.50 mm, Number of poles: 11, 90°, Solder pin length (l): 3.2 mm, tinned, orange, Box	IEC: 320 V / 17 A UL: 300 V / 10 A	Box
GTIN (EAN)	4008190173883			
Qty.	50 pc(s).			
Type	SL 3.50/11/90 4.5SN OR ...	Version	Product data	Packaging
Order No.	1605460000	PCB plug-in connector, male header, open side, THT solder connection, 3.50 mm, Number of poles: 11, 90°, Solder pin length (l): 4.5 mm, tinned, orange, Box	IEC: 320 V / 17 A UL: 300 V / 10 A	Box
GTIN (EAN)	4008190004767			
Qty.	50 pc(s).			

**OMNIMATE Signal - series BL/SL 3.50
BLZF 3.50/11/180 SN BK BX**

Weidmüller Interface GmbH & Co. KG
Klingenbergstraße 26
D-32758 Detmold
Germany
Fon: +49 5231 14-0
Fax: +49 5231 14-292083
www.weidmueller.com

Mating connector (fully pluggable)

Type	SL 3.50/11/90 3.2SN GY ...	Version	Product data	Packaging
Order No.	1619160000	PCB plug-in connector, male header, open side, THT solder	IEC: 320 V / 17 A	Box
GTIN (EAN)	4008190134716	connection, 3.50 mm, Number of poles: 11, 90°, Solder pin length (l):	UL: 300 V / 10 A	
Qty.	50 pc(s).	3.2 mm, tinned, Pebble grey, Box		
Type	SL 3.50/11/90 4.5SN BK ...	Version	Product data	Packaging
Order No.	1615370000	PCB plug-in connector, male header, open side, THT solder	IEC: 320 V / 17 A	Box
GTIN (EAN)	4008190053031	connection, 3.50 mm, Number of poles: 11, 90°, Solder pin length (l):	UL: 300 V / 10 A	
Qty.	50 pc(s).	4.5 mm, tinned, black, Box		
Type	SL 3.50/11/90 3.2SN DKG ...	Version	Product data	Packaging
Order No.	1606860000	PCB plug-in connector, male header, open side, THT solder	IEC: 320 V / 17 A	Box
GTIN (EAN)	4008190047825	connection, 3.50 mm, Number of poles: 11, 90°, Solder pin length (l):	UL: 300 V / 10 A	
Qty.	50 pc(s).	3.2 mm, tinned, Signal green, Box		

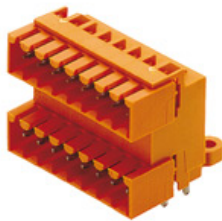
SLD 3.50/90G

Two-tier pin header for wave soldering in 3.50 mm pitch. The connector is available in open, closed and flange versions. The male connectors provide space for labelling and can be coded. Packed in a cardboard box.

General ordering data

Type	SLD 3.50/22/90G 3.2SN D ...	Version	Product data	Packaging
Order No.	1674950000	PCB plug-in connector, male header, closed side, THT solder	IEC: 200 V / 10.5 A	Box
GTIN (EAN)	4008190445645	connection, 3.50 mm, Number of poles: 22, 90°, Solder pin length (l):	UL: 300 V / 8 A	
Qty.	10 pc(s).	3.2 mm, tinned, Signal green, Box		
Type	SLD 3.50/22/90G 4.5SN B ...	Version	Product data	Packaging
Order No.	1634360000	PCB plug-in connector, male header, closed side, THT solder	IEC: 200 V / 10.5 A	Box
GTIN (EAN)	4008190258818	connection, 3.50 mm, Number of poles: 22, 90°, Solder pin length (l):	UL: 300 V / 8 A	
Qty.	10 pc(s).	4.5 mm, tinned, black, Box		
Type	SLD 3.50/22/90G 3.2SN O ...	Version	Product data	Packaging
Order No.	1633670000	PCB plug-in connector, male header, closed side, THT solder	IEC: 200 V / 10.5 A	Box
GTIN (EAN)	4008190258122	connection, 3.50 mm, Number of poles: 22, 90°, Solder pin length (l):	UL: 300 V / 8 A	
Qty.	10 pc(s).	3.2 mm, tinned, orange, Box		

OMNIMATE Signal - series BL/SL 3.50 BLZF 3.50/11/180 SN BK BX

Weidmüller Interface GmbH & Co. KG
 Klingenbergstraße 26
 D-32758 Detmold
 Germany
 Fon: +49 5231 14-0
 Fax: +49 5231 14-292083
 www.weidmueller.com

Accessories

Strain reliefs



For frequent load changes: the "trailer coupling" for plug-in connectors.

The strain relief can do more than just relieve the strain on conductors:

Simply clip onto the plug and

- bundle conductors
- guide cables
- use as a connection and disconnection aid

No damage to the connecting points, clear, tidy wiring and easy to handle.

User advantages: permanent heavy-duty connections for harsh industrial environments and convenient operation ensure improved system availability.

General ordering data

Type	BL 3.50 ZE08 BK BX	Version	Product data	Packaging
Order No.	1627830000		PCB plug-in connector, Accessories, Strain relief, black, Number of	Box
GTIN (EAN)	4008190202576		poles: 8	
Qty.	50 pc(s).			
Type	BL 3.50 ZE03 BK BX	Version	Product data	Packaging
Order No.	1627820000		PCB plug-in connector, Accessories, Strain relief, black, Number of	Box
GTIN (EAN)	4008190202552		poles: 3	
Qty.	50 pc(s).			
Type	BL 3.50 ZE03 OR BX	Version	Product data	Packaging
Order No.	1629680000		PCB plug-in connector, Accessories, Strain relief, orange, Number of	Box
GTIN (EAN)	4008190202569		poles: 3	
Qty.	50 pc(s).			
Type	BL 3.50 ZE08 OR BX	Version	Product data	Packaging
Order No.	1629690000		PCB plug-in connector, Accessories, Strain relief, orange, Number of	Box
GTIN (EAN)	4008190202583		poles: 8	
Qty.	50 pc(s).			

OMNIMATE Signal - series BL/SL 3.50 BLZF 3.50/11/180 SN BK BX

Weidmüller Interface GmbH & Co. KG
 Klingenbergstraße 26
 D-32758 Detmold
 Germany
 Fon: +49 5231 14-0
 Fax: +49 5231 14-292083
 www.weidmueller.com

Accessories

Coding elements



**Only connects what is supposed to be connected:
the right connection at the right place.**

Coding elements and locking devices clearly assign connecting elements during the manufacturing process and operation

The coding elements and locking devices are inserted prior to assembly or during the cable assembly phase. The Weidmüller alternative: configure online using the variant configurator to precode prior to delivery.

Incorrect assembly on the circuit board and incorrect plugging of connecting elements is no longer possible. The advantage: no troubleshooting during manufacture and no operational errors by the user.

General ordering data

Type	BL SL 3.5 KO SW	Version	Product data	Packaging
Order No.	1610100000	PCB plug-in connector, Accessories, Coding element, black, Number		Box
GTIN (EAN)	4008190187637	of poles: 1		
Qty.	100 pc(s).			
Type	BL SL 3.5 KO OR	Version	Product data	Packaging
Order No.	1693430000	PCB plug-in connector, Accessories, Coding element, orange, Number		Box
GTIN (EAN)	4008190867447	of poles: 1		
Qty.	100 pc(s).			

SHOWN: BLZF 3.50/04/180

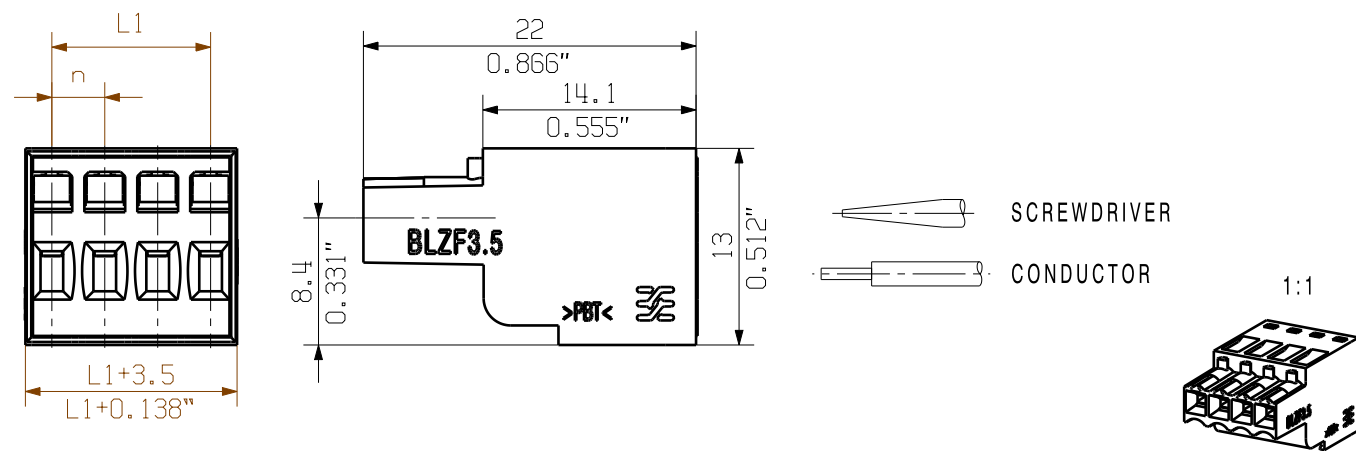

SHOWN: BLZF 3.50/04/180F

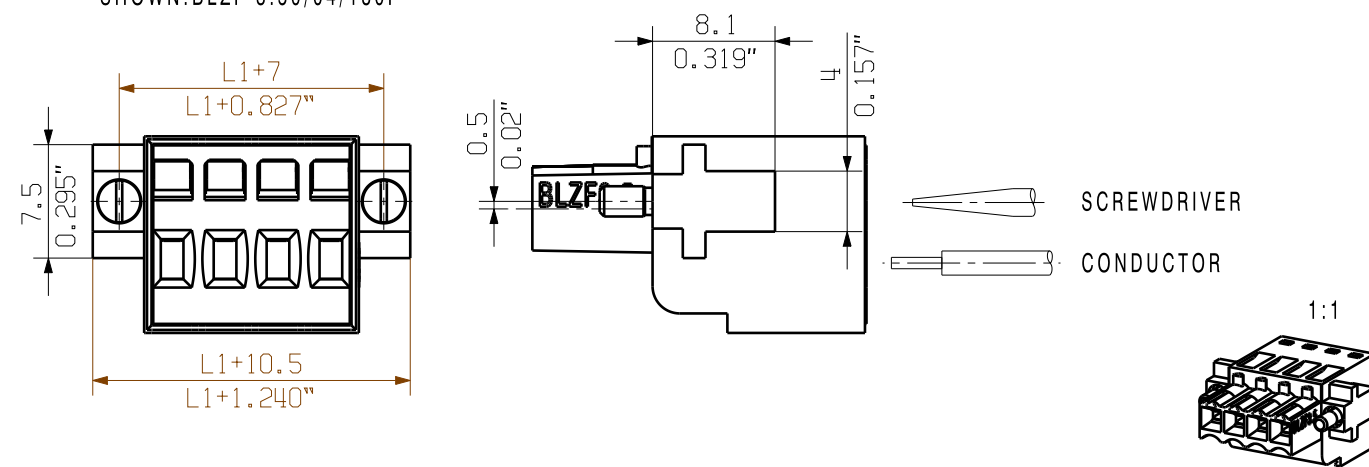

SHOWN: BLZF 3.50/04/180/SO

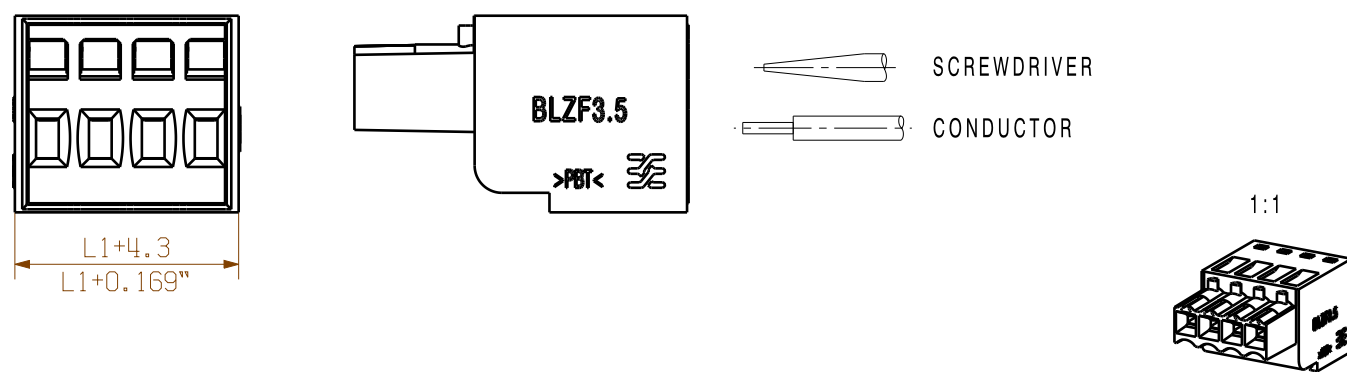

SHOWN: BLZF 3.50/04/180LR REDESIGN

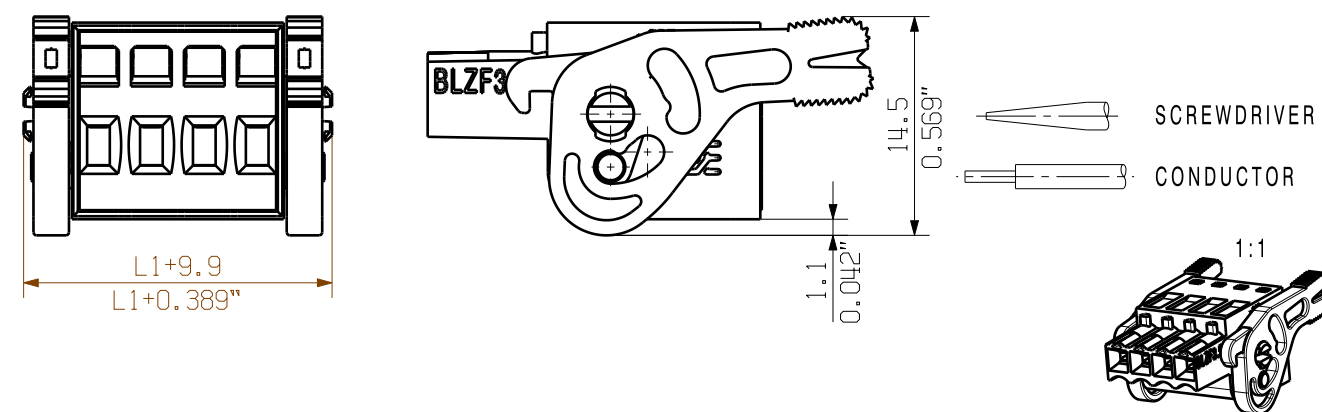

SHOWN: BLZF 3.50/04/180LR

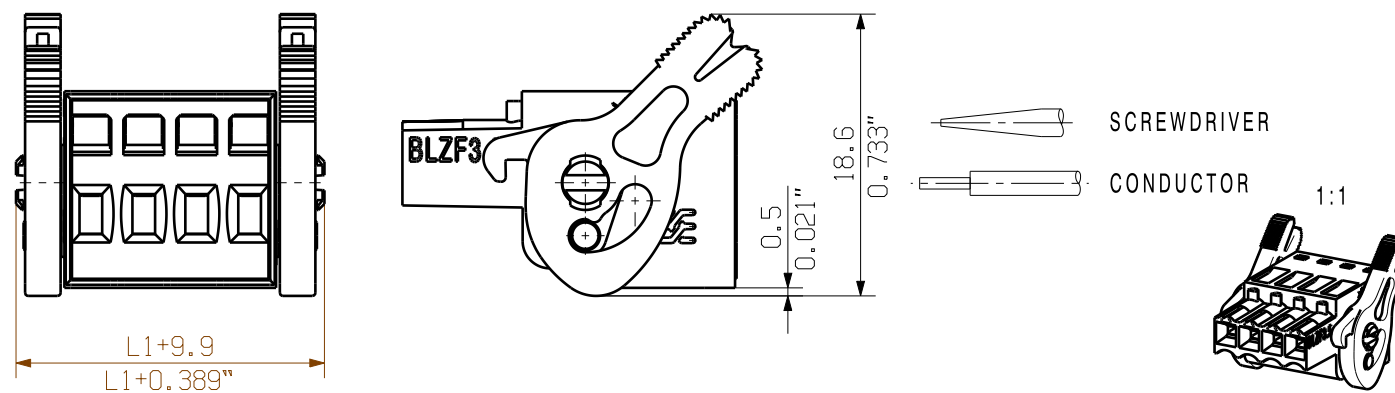

SHOWN: BLZF 3.50/04/180LH

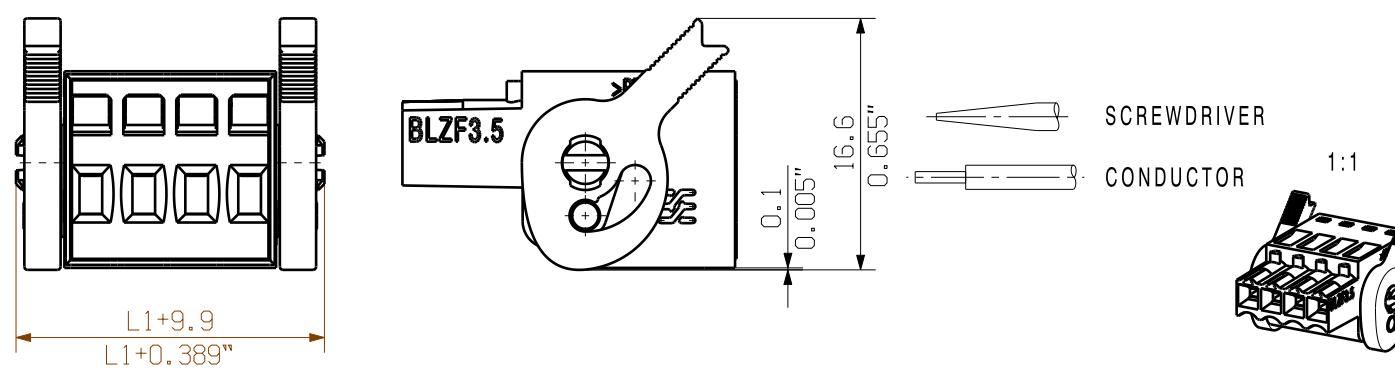

ALLGEMEINGUELTIGE KUNDENZEICHNUNG, AKTUELLER STAND NUR AUF ANFRAGE
GENERAL CUSTOMER DRAWING, TOPICAL VERSION ONLY IF REQUIRED

For the mounting of PCBs, it should be noted that the rated data given in the catalogue relates only to the connection elements. The necessary creepage and clearance paths must be observed in connection with the respective applicant in accordance with VDE 0110. The current-carrying capacity and pitch tolerance is to be determined according to DIN IEC 326 part 3 very fine.

Weidmüller connectors are tested to the DIN VDE 0627 standard, and are valid for its field of application. Provided that the connectors are used to the intended purpose, all requirements with respect to the occurring of electrical, mechanical, thermic and corrosive stress will be satisfied.

24	80.5	3.169
23	77.0	3.032
22	73.5	2.894
21	70.0	2.756
20	66.5	2.618
19	63.0	2.480
18	59.5	2.343
17	56.0	2.205
16	52.5	2.067
15	49.0	1.929
14	45.5	1.791
13	42.0	1.654
12	38.5	1.516
11	35.0	1.378
10	31.5	1.240
9	28.0	1.102
8	24.5	0.965
7	21.0	0.827
6	17.5	0.689
5	14.0	0.551
4	10.5	0.413
3	7.0	0.276
2	3.5	0.138
POLZAHL POLES	L1 (mm)	L1 (inch)

	DIN ISO 2768-m	Cat.no.: .	
	93783/5 24.11.17 HELIS_MA 02		
Modification		3 23142	
		Drawing no. 3 23142 Issue no. 20 Sheet 01 of 01 sheets	
Scale: 2/1	Drawn 10.12.2007 HELIS_MA Responsible AMANN_A Checked 08.01.2018 HELIS_MA Supersedes: .	Date Name Approved LANG_T	BLZF 3.50/././180.. BUCHSENSTECKER FEMALE PLUG Product file: BLZF 3.50
		7357	