

OMNIMATE Signal - series BL/SL 3.50 BLZF 3.50/10/180 SN OR BX

Weidmüller Interface GmbH & Co. KG
Klingenbergstraße 26
D-32758 Detmold
Germany
Fon: +49 5231 14-0
Fax: +49 5231 14-292083
www.weidmueller.com

Product image

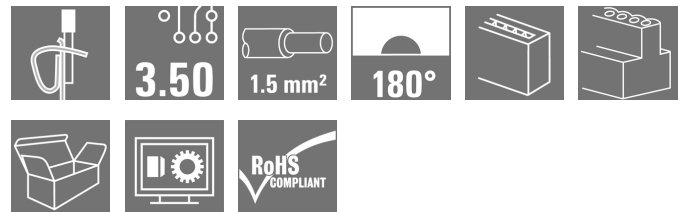

Similar to illustration

Female connectors with tension clamp system for connecting cables in 3.50 pitch. They provide space for labelling and can be coded.

General ordering data

| | |
|--------------|---|
| Type | BLZF 3.50/10/180 SN OR BX |
| Order No. | 1690270000 |
| Version | PCB plug-in connector, female plug, 3.50 mm, Number of poles: 10, 180°, Tension-clamp connection, Clamping range, max. : 1.5 mm², Box |
| GTIN (EAN) | 4008190328764 |
| Qty. | 50 pc(s). |
| Product data | IEC: 320 V / 14.5 A / 0.2 - 1.5 mm² UL: 300 V / 10 A / AWG 26 - AWG 14 |
| Packaging | Box |

Creation date May 3, 2020 1:50:26 PM CEST

OMNIMATE Signal - series BL/SL 3.50
BLZF 3.50/10/180 SN OR BX

Weidmüller Interface GmbH & Co. KG
 Klingenbergstraße 26
 D-32758 Detmold
 Germany
 Fon: +49 5231 14-0
 Fax: +49 5231 14-292083
 www.weidmueller.com

Technical data
Dimensions and weights

| | | | |
|------------|--------|-----------------|------------|
| Width | 35 mm | Width (inches) | 1.378 inch |
| Height | 13 mm | Height (inches) | 0.512 inch |
| Depth | 22 mm | Depth (inches) | 0.866 inch |
| Net weight | 9.36 g | | |

System Parameters

| Product family | OMNIMATE Signal - series BL/SL 3.50 | Type of connection | Field connection |
|--|-------------------------------------|--|---------------------|
| Wire connection method | Tension-clamp connection | Pitch in mm (P) | 3.5 mm |
| Pitch in inches (P) | 0.138 inch | Conductor outlet direction | 180° |
| Number of poles | 10 | L1 in mm | 31.5 mm |
| L1 in inches | 1.24 inch | Number of rows | 1 |
| Pin series quantity | 1 | Rated cross-section | 1.5 mm ² |
| Touch-safe protection acc. to DIN VDE 57 106 | Safe from finger touch | Touch-safe protection acc. to DIN VDE 0470 | IP 20 |
| Volume resistance | ≤ 5mΩ | Can be coded | Yes |
| Stripping length | 10 mm | Screwdriver blade | 0.4 x 2.5 |
| Screwdriver blade standard | DIN 5264-A | Plugging cycles | 25 |
| Plugging force/pole, max. | 7 N | Pulling force/pole, max. | 5 N |

Material data

| Insulating material | PBT | Colour | orange |
|---------------------------------------|--------------------------|---------------------------------------|---------------------|
| Colour chart (similar) | RAL 2000 | Insulating material group | IIIa |
| Comparative Tracking Index (CTI) | ≥ 200 | Insulation strength | ≥ 10 ⁸ Ω |
| UL 94 flammability rating | V-0 | GWFI | 960 °C |
| Contact material | Copper alloy | Contact surface | tinned |
| Layer structure of plug contact | 4-8 μm Sn hot-dip tinned | Storage temperature, min. | -25 °C |
| Storage temperature, max. | 50 °C | Max. relative humidity during storage | 80 % |
| Operating temperature, min. | -50 °C | Operating temperature, max. | 100 °C |
| Temperature range, installation, min. | -30 °C | Temperature range, installation, max. | 100 °C |

Conductors suitable for connection

| | |
|---|----------------------|
| Clamping range, min. | 0.13 mm ² |
| Clamping range, max. | 1.5 mm ² |
| Wire connection cross section AWG, min. | AWG 28 |
| Wire connection cross section AWG, max. | AWG 16 |
| Solid, min. H05(07) V-U | 0.2 mm ² |
| Solid, max. H05(07) V-U | 1.5 mm ² |
| Flexible, min. H05(07) V-K | 0.2 mm ² |
| Flexible, max. H05(07) V-K | 1.5 mm ² |
| w. plastic collar ferrule, DIN 46228 pt 4, 0.2 mm ² min. | |
| w. plastic collar ferrule, DIN 46228 pt 4, 1 mm ² max. | |
| w. wire end ferrule, DIN 46228 pt 1, min. | 0.2 mm ² |
| w. wire end ferrule, DIN 46228 pt 1, max. | 1.5 mm ² |
| Outer diameter of insulation, max. | 2.9 mm |
| Plug gauge in accordance with EN 60999 a x b; ø | 2.4 mm x 1.5 mm |

Creation date May 3, 2020 1:50:26 PM CEST

OMNIMATE Signal - series BL/SL 3.50
BLZF 3.50/10/180 SN OR BX

Weidmüller Interface GmbH & Co. KG
 Klingenbergstraße 26
 D-32758 Detmold
 Germany
 Fon: +49 5231 14-0
 Fax: +49 5231 14-292083
 www.weidmueller.com

Technical data

| | | | | |
|--|--|------------------------------|----------------------------|-------|
| Clampable conductor | Cross-section for conductor connection | Type | fine-wired | |
| | | nominal | 0.5 mm ² | |
| | wire end ferrule | Stripping length | nominal | 12 mm |
| | | Recommended wire-end ferrule | H0.5/16 OR | |
| | | Stripping length | nominal | 10 mm |
| | | Recommended wire-end ferrule | H0.5/10 | |
| | Cross-section for conductor connection | Type | fine-wired | |
| | | nominal | 0.75 mm ² | |
| | wire end ferrule | Stripping length | nominal | 12 mm |
| | | Recommended wire-end ferrule | H0.75/16 W | |
| | | Stripping length | nominal | 10 mm |
| | | Recommended wire-end ferrule | H0.75/10 | |
| | Cross-section for conductor connection | Type | fine-wired | |
| | | nominal | 1 mm ² | |
| | wire end ferrule | Stripping length | nominal | 12 mm |
| | | Recommended wire-end ferrule | H1.0/16D R | |
| Stripping length | | nominal | 10 mm | |
| Recommended wire-end ferrule | | H1.0/10 | | |
| Cross-section for conductor connection | Type | fine-wired | | |
| | nominal | 1.5 mm ² | | |
| wire end ferrule | Stripping length | nominal | 10 mm | |
| | Recommended wire-end ferrule | H1.5/10 | | |

Reference text The outside diameter of the plastic collar should not be larger than the pitch (P), Length of ferrules is to be chosen depending on the product and the rated voltage.

Max. clamping range 1.5 mm²

Rated data acc. to IEC

| | | | |
|---|------------------------|---|-------------------|
| tested acc. to standard | IEC 60664-1, IEC 61984 | Rated current, min. number of poles (Tu=20°C) | 14.5 A |
| Rated current, max. number of poles (Tu=20°C) | 10 A | Rated current, min. number of poles (Tu=40°C) | 12 A |
| Rated current, max. number of poles (Tu=40°C) | 8 A | Rated voltage for surge voltage class / pollution degree II/2 | 320 V |
| Rated voltage for surge voltage class / pollution degree III/2 | 160 V | Rated voltage for surge voltage class / pollution degree III/3 | 160 V |
| Rated impulse voltage for surge voltage class/ pollution degree II/2 | 2.5 kV | Rated impulse voltage for surge voltage class/ pollution degree III/2 | 2.5 kV |
| Rated impulse voltage for surge voltage class/ contamination degree III/3 | 2.5 kV | Short-time withstand current resistance | 3 x 1s with 100 A |

Data sheet

**OMNIMATE Signal - series BL/SL 3.50
BLZF 3.50/10/180 SN OR BX**

Weidmüller Interface GmbH & Co. KG
Klingenbergstraße 26
D-32758 Detmold
Germany
Fon: +49 5231 14-0
Fax: +49 5231 14-292083
www.weidmueller.com

Technical data

Rated data acc. to CSA

| | | | | | |
|-----------------------------------|--|---|--------|-----------------------|--|
| Institute (CSA) | |  | | Certificate No. (CSA) | |
| | | | | 200039-1461395 | |
| Rated voltage (Use group B / CSA) | 300 V | Rated voltage (Use group D / CSA) | 300 V | | |
| Rated current (Use group B / CSA) | 10 A | Rated current (Use group D / CSA) | 10 A | | |
| Wire cross-section, AWG, min. | AWG 26 | Wire cross-section, AWG, max. | AWG 14 | | |
| Reference to approval values | Specifications are maximum values, details - see approval certificate. | | | | |

Rated data acc. to UL 1059

| | | | | | |
|---------------------------------------|--|---|--------|----------------------|--|
| Institute (UR) | |  | | Certificate No. (UR) | |
| | | | | E60693 | |
| Rated voltage (Use group B / UL 1059) | 300 V | Rated voltage (Use group D / UL 1059) | 300 V | | |
| Rated current (Use group B / UL 1059) | 10 A | Rated current (Use group D / UL 1059) | 10 A | | |
| Wire cross-section, AWG, min. | AWG 26 | Wire cross-section, AWG, max. | AWG 14 | | |
| Reference to approval values | Specifications are maximum values, details - see approval certificate. | | | | |

Packing

| | | | |
|-----------|--------|------------|--------|
| Packaging | Box | VPE length | 66 mm |
| VPE width | 108 mm | VPE height | 134 mm |

Classifications

| | | | |
|-------------|-------------|------------|-------------|
| ETIM 6.0 | EC002638 | ETIM 7.0 | EC002638 |
| eClass 9.0 | 27-44-03-09 | eClass 9.1 | 27-44-03-09 |
| eClass 10.0 | 27-44-03-09 | UNSPSC | 30-21-18-10 |

OMNIMATE Signal - series BL/SL 3.50 BLZF 3.50/10/180 SN OR BX

Weidmüller Interface GmbH & Co. KG
 Klingenbergstraße 26
 D-32758 Detmold
 Germany
 Fon: +49 5231 14-0
 Fax: +49 5231 14-292083
 www.weidmueller.com

Technical data

Notes

- | | |
|-------|---|
| Notes | <ul style="list-style-type: none"> • Additional colours on request • Gold-plated contact surfaces on request • Rated current related to rated cross-section & min. No. of poles. • Max. outer diameter of the conductor: 2.9 mm • Wire end ferrule without plastic collar to DIN 46228/1 • Wire end ferrule with plastic collar to DIN 46228/4 • Crimp shape A for wire-end ferrules with crimping tools PZ 1,5 (order no. 9005990000) or PZ 6/5 (order no. 9011460000) for larger wire cross-sections recommended. • P on drawing = pitch • Rated data refer only to the component itself. Clearance and creepage distances to other components are to be designed in accordance with the relevant application standards. |
|-------|---|

| | |
|----------------|--|
| IPC conformity | Conformity: The products are developed, manufactured and delivered according international recognized standards and norms and comply with the assured properties in the data sheet resp. fulfill decorative properties in accordance with IPC-A-610 "Class 2". Further claims on the products can be evaluated on request. |
|----------------|--|

Approvals

Approvals



| | |
|------|---------|
| ROHS | Conform |
|------|---------|

Downloads

| | |
|---|--|
| Approval/Certificate/Document of Conformity | Declaration of the Manufacturer |
| Brochure/Catalogue | FL DRIVES EN MB DEVICE MANUF. EN FL DRIVES DE CAT 2 PORTFOLIOGUIDE EN FL BUILDING SAFETY EN FL APPL LED LIGHTING EN FLIndustr.CONTROLS EN FL MACHINE SAFETY EN FL HEATING ELECTR EN FL APPL INVERTER EN FL_BASE_STATION_EN FL ELEVATOR EN FL POWER SUPPLY EN FL 72H SAMPLE SER EN PO OMNIMATE EN |
| Engineering Data | EPLAN_WSCAD_Zuken E3.S |
| Engineering Data | STEP |

Data sheet

**OMNIMATE Signal - series BL/SL 3.50
BLZF 3.50/10/180 SN OR BX**

Weidmüller Interface GmbH & Co. KG
Klingenbergstraße 26
D-32758 Detmold
Germany
Fon: +49 5231 14-0
Fax: +49 5231 14-292083
www.weidmueller.com

Drawings

Dimensional drawing

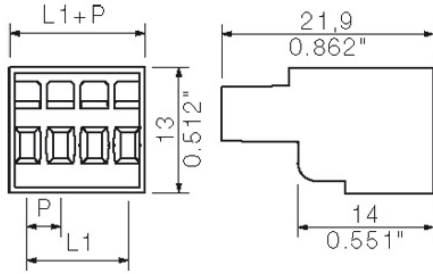

Graph

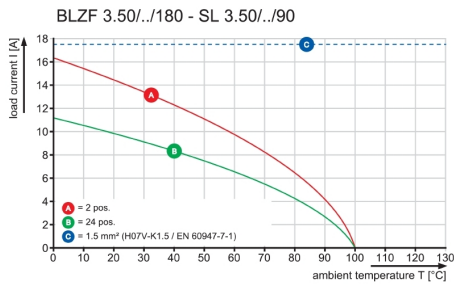

Graph

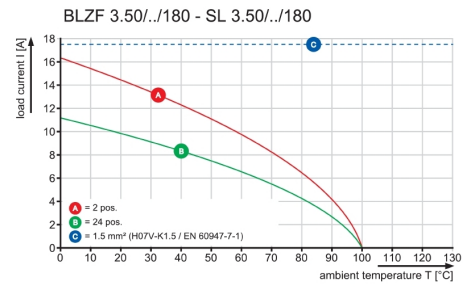

Graph

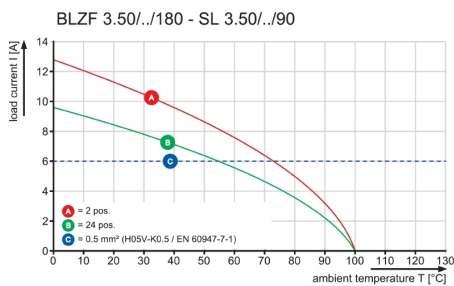

**OMNIMATE Signal - series BL/SL 3.50
BLZF 3.50/10/180 SN OR BX**

Weidmüller Interface GmbH & Co. KG
Klingenbergstraße 26
D-32758 Detmold
Germany
Fon: +49 5231 14-0
Fax: +49 5231 14-292083
www.weidmueller.com

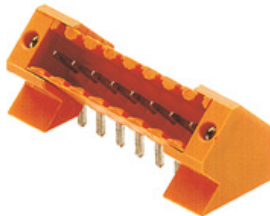
Mating connector (conditionally pluggable)
SL 3.50/135F

Pin headers for wave soldering in 3.50 mm pitch

- Plugging direction is parallel (90°), straight 180° or angled (135°) to the PCB
- Housing variant: screw flange (F)
- Packed in a cardboard box (BX)
- Pin header can be coded

General ordering data

| Type | SL 3.50/10/135F 3.2SN O ... | Version | Product data | Packaging |
|------------|-----------------------------|--|-------------------|-----------|
| Order No. | 1643410000 | PCB plug-in connector, male header, Flange, THT solder connection, | IEC: 320 V / 15 A | Box |
| GTIN (EAN) | 4008190282172 | 3.50 mm, Number of poles: 10, 135°, Solder pin length (l): 3.2 mm, | UL: 300 V / 10 A | |
| Qty. | 42 pc(s). | tinned, orange, Box | | |

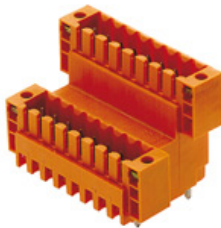
SLD 3.50V/180F

Double-level, staggered pin header for wave soldering at 3.50 mm pitch. They are available in closed and flanged versions. The male connectors provide space for labelling and can be coded.

General ordering data

| Type | SLD 3.50 V/20/180F 3.2 ... | Version | Product data | Packaging |
|------------|----------------------------|--|---------------------|-----------|
| Order No. | 1641280000 | PCB plug-in connector, male header, Flange, THT solder connection, | IEC: 200 V / 10.5 A | Box |
| GTIN (EAN) | 4008190279684 | 3.50 mm, Number of poles: 20, 180°, Solder pin length (l): 3.2 mm, | UL: 300 V / 8 A | |
| Qty. | 20 pc(s). | tinned, orange, Box | | |

**OMNIMATE Signal - series BL/SL 3.50
BLZF 3.50/10/180 SN OR BX**

Weidmüller Interface GmbH & Co. KG
 Klingenbergstraße 26
 D-32758 Detmold
 Germany
 Fon: +49 5231 14-0
 Fax: +49 5231 14-292083
 www.weidmueller.com

Mating connector (conditionally pluggable)**SL-SMT 3.5/90LF Box**

High-temperature-resistant male header, 3.50 mm pitch.

- **Plugging direction parallel (90°), straight 180° or angled (135°) to PCB**
- **Housing variants: closed side (G), screw flange (F), solder flange (LF) or snap-on solder flange (RF)**
- **Optimised for the SMT process**
- **Pin length 3.2 mm universal for all soldering methods**
- **Pin length 1.5 mm optimised for reflow soldering methods**
- **Packed either in a box (BX) or tape-on-reel (RL)**
- **Male header can be coded**

General ordering data

| Type | SL-SMT 3.50/10/90LF 3.2 ... | Version | Product data | Packaging |
|------------|-----------------------------|---|-------------------|-----------|
| Order No. | 1841940000 | PCB plug-in connector, male header, Solder flange, THT/THR solder | IEC: 320 V / 15 A | Box |
| GTIN (EAN) | 4032248353293 | connection, 3.50 mm, Number of poles: 10, 90°, Solder pin length (l): | UL: 300 V / 10 A | |
| Qty. | 42 pc(s). | 3.2 mm, tinned, black, Box | | |
| Type | SL-SMT 3.50/10/90LF 1.5 ... | Version | Product data | Packaging |
| Order No. | 1805020000 | PCB plug-in connector, male header, Solder flange, THT/THR solder | IEC: 320 V / 15 A | Box |
| GTIN (EAN) | 4032248268924 | connection, 3.50 mm, Number of poles: 10, 90°, Solder pin length (l): | UL: 300 V / 10 A | |
| Qty. | 42 pc(s). | 1.5 mm, tinned, black, Box | | |

SL-SMT 3.5/180F Box

High-temperature-resistant male header, 3.50 mm pitch.

- **Plugging direction parallel (90°), straight 180° or angled (135°) to PCB**
- **Housing variants: closed side (G), screw flange (F), solder flange (LF) or snap-on solder flange (RF)**
- **Optimised for the SMT process**
- **Pin length 3.2 mm universal for all soldering methods**
- **Pin length 1.5 mm optimised for reflow soldering methods**
- **Packed either in a box (BX) or tape-on-reel (RL)**
- **Male header can be coded**

General ordering data

| Type | SL-SMT 3.50/10/180F 3.2 ... | Version | Product data | Packaging |
|------------|-----------------------------|---|-------------------|-----------|
| Order No. | 1842850000 | PCB plug-in connector, male header, Flange, THT/THR solder | IEC: 320 V / 15 A | Box |
| GTIN (EAN) | 4032248354313 | connection, 3.50 mm, Number of poles: 10, 180°, Solder pin length | UL: 300 V / 10 A | |
| Qty. | 42 pc(s). | (l): 3.2 mm, tinned, black, Box | | |

Creation date May 3, 2020 1:50:26 PM CEST

**OMNIMATE Signal - series BL/SL 3.50
BLZF 3.50/10/180 SN OR BX**

Weidmüller Interface GmbH & Co. KG
Klingenbergstraße 26
D-32758 Detmold
Germany
Fon: +49 5231 14-0
Fax: +49 5231 14-292083
www.weidmueller.com

Mating connector (conditionally pluggable)

| Type | SL-SMT 3.50/10/180F 1.5 ... | Version | Product data | Packaging |
|------------|-----------------------------|---|---------------------------------------|-----------|
| Order No. | 1761042001 | PCB plug-in connector, male header, Flange, THT/THR solder connection, 3.50 mm, Number of poles: 10, 180°, Solder pin length (l): 1.5 mm, tinned, black, Box | IEC: 320 V / 15 A UL: 300 V / 10 A | Box |
| GTIN (EAN) | 4032248131617 | | | |
| Qty. | 42 pc(s). | | | |
| Type | SL-SMT 3.50/10/180F 1.5 ... | Version | Product data | Packaging |
| Order No. | 1761043001 | PCB plug-in connector, male header, Flange, THT/THR solder connection, 3.50 mm, Number of poles: 10, 180°, Solder pin length (l): 1.5 mm, tinned, black, Tray | IEC: 320 V / 15 A UL: 300 V / 10 A | Tray |
| GTIN (EAN) | 4032248133420 | | | |
| Qty. | 36 pc(s). | | | |

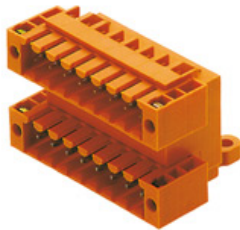
SLD 3.50/90F

Two-tier pin header for wave soldering in 3.50 mm pitch. The connector is available in open, closed and flange versions. The male connectors provide space for labelling and can be coded. Packed in a cardboard box.

General ordering data

| Type | SLD 3.50/20/90F 3.2SN O ... | Version | Product data | Packaging |
|------------|-----------------------------|--|--|-----------|
| Order No. | 1633890000 | PCB plug-in connector, male header, Flange, THT solder connection, 3.50 mm, Number of poles: 20, 90°, Solder pin length (l): 3.2 mm, tinned, orange, Box | IEC: 200 V / 10.5 A UL: 300 V / 8 A | Box |
| GTIN (EAN) | 4008190258344 | | | |
| Qty. | 20 pc(s). | | | |

SLD 3.50V/90F

Double-level, staggered pin header for wave soldering at 3.50 mm pitch. They are available in closed and flanged versions. The male connectors provide space for labelling and can be coded.

General ordering data

| Type | SLD 3.50 V/20/90F 3.2 S ... | Version | Product data | Packaging |
|------------|-----------------------------|--|--|-----------|
| Order No. | 1642410000 | PCB plug-in connector, male header, Flange, THT solder connection, 3.50 mm, Number of poles: 20, 90°, Solder pin length (l): 3.2 mm, tinned, orange, Box | IEC: 200 V / 10.5 A UL: 300 V / 8 A | Box |
| GTIN (EAN) | 4008190280932 | | | |
| Qty. | 20 pc(s). | | | |

**OMNIMATE Signal - series BL/SL 3.50
BLZF 3.50/10/180 SN OR BX**

Weidmüller Interface GmbH & Co. KG
 Klingenbergstraße 26
 D-32758 Detmold
 Germany
 Fon: +49 5231 14-0
 Fax: +49 5231 14-292083
 www.weidmueller.com

Mating connector (conditionally pluggable)**SL-SMT 3.5/180G Box**

High-temperature-resistant male header, 3.50 mm pitch.

- **Plugging direction parallel (90°), straight 180° or angled (135°) to PCB**
- **Housing variants: closed side (G), screw flange (F), solder flange (LF) or snap-on solder flange (RF)**
- **Optimised for the SMT process**
- **Pin length 3.2 mm universal for all soldering methods**
- **Pin length 1.5 mm optimised for reflow soldering methods**
- **Packed either in a box (BX) or tape-on-reel (RL)**
- **Male header can be coded**

General ordering data

| Type | SL-SMT 3.50/10/180G 1.5 ... | Version | Product data | Packaging |
|------------|-----------------------------|---|---------------------------------------|-----------|
| Order No. | 1753062001 | PCB plug-in connector, male header, closed side, THT/THR solder connection, 3.50 mm, Number of poles: 10, 180°, Solder pin length (l): 1.5 mm, tinned, black, Box | IEC: 320 V / 15 A UL: 300 V / 10 A | Box |
| GTIN (EAN) | 4032248130962 | | | |
| Qty. | 50 pc(s). | | | |
| Type | SL-SMT 3.50/10/180G 3.2 ... | Version | Product data | Packaging |
| Order No. | 1836990000 | PCB plug-in connector, male header, closed side, THT/THR solder connection, 3.50 mm, Number of poles: 10, 180°, Solder pin length (l): 3.2 mm, tinned, black, Box | IEC: 320 V / 15 A UL: 300 V / 10 A | Box |
| GTIN (EAN) | 4032248345076 | | | |
| Qty. | 50 pc(s). | | | |

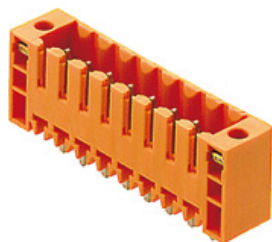
SL 3.50/180F

Pin headers for wave soldering in 3.50 mm pitch

- **Plugging direction is parallel (90°), straight 180° or angled (135°) to the PCB**
- **Housing variant: screw flange (F)**
- **Packed in a cardboard box (BX)**
- **Pin header can be coded**

General ordering data

| Type | SL 3.50/10/180F 4.5SN O ... | Version | Product data | Packaging |
|------------|-----------------------------|--|---------------------------------------|-----------|
| Order No. | 1618760000 | PCB plug-in connector, male header, Flange, THT solder connection, 3.50 mm, Number of poles: 10, 180°, Solder pin length (l): 4.5 mm, tinned, orange, Box | IEC: 320 V / 17 A UL: 300 V / 10 A | Box |
| GTIN (EAN) | 4008190127473 | | | |
| Qty. | 50 pc(s). | | | |
| Type | SL 3.50/10/180F 3.2SN G ... | Version | Product data | Packaging |
| Order No. | 1622340000 | PCB plug-in connector, male header, Flange, THT solder connection, 3.50 mm, Number of poles: 10, 180°, Solder pin length (l): 3.2 mm, tinned, Pebble grey, Box | IEC: 320 V / 17 A UL: 300 V / 10 A | Box |
| GTIN (EAN) | 4008190190040 | | | |
| Qty. | 50 pc(s). | | | |

OMNIMATE Signal - series BL/SL 3.50 BLZF 3.50/10/180 SN OR BX

Weidmüller Interface GmbH & Co. KG
 Klingenbergstraße 26
 D-32758 Detmold
 Germany
 Fon: +49 5231 14-0
 Fax: +49 5231 14-292083
 www.weidmueller.com

Mating connector (conditionally pluggable)

| Type | SL 3.50/10/180F 3.2SN O ... | Version | Product data | Packaging |
|------------|-----------------------------|--|-------------------|-----------|
| Order No. | 1607580000 | PCB plug-in connector, male header, Flange, THT solder connection, | IEC: 320 V / 17 A | Box |
| GTIN (EAN) | 4008190187545 | 3.50 mm, Number of poles: 10, 180°, Solder pin length (l): 3.2 mm, | UL: 300 V / 10 A | |
| Qty. | 50 pc(s). | tinned, orange, Box | | |
| Type | SL 3.50/10/180F 3.2SN D ... | Version | Product data | Packaging |
| Order No. | 1622560000 | PCB plug-in connector, male header, Flange, THT solder connection, | IEC: 320 V / 17 A | Box |
| GTIN (EAN) | 4008190193225 | 3.50 mm, Number of poles: 10, 180°, Solder pin length (l): 3.2 mm, | UL: 300 V / 10 A | |
| Qty. | 50 pc(s). | tinned, Signal green, Box | | |
| Type | SL 3.50/10/180F 4.5 SN ... | Version | Product data | Packaging |
| Order No. | 1616210000 | PCB plug-in connector, male header, Flange, THT solder connection, | IEC: 320 V / 17 A | Box |
| GTIN (EAN) | 4008190068929 | 3.50 mm, Number of poles: 10, 180°, Solder pin length (l): 4.5 mm, | UL: 300 V / 10 A | |
| Qty. | 50 pc(s). | tinned, black, Box | | |

SL-SMT 3.5/90F Box



High-temperature-resistant male header, 3.50 mm pitch.

- **Plugging direction parallel (90°), straight 180° or angled (135°) to PCB**
- **Housing variants: closed side (G), screw flange (F), solder flange (LF) or snap-on solder flange (RF)**
- **Optimised for the SMT process**
- **Pin length 3.2 mm universal for all soldering methods**
- **Pin length 1.5 mm optimised for reflow soldering methods**
- **Packed either in a box (BX) or tape-on-reel (RL)**
- **Male header can be coded**

General ordering data

| Type | SL-SMT 3.50/10/90F 1.5S ... | Version | Product data | Packaging |
|------------|-----------------------------|---|-------------------|-----------|
| Order No. | 1762082001 | PCB plug-in connector, male header, Flange, THT/THR solder | IEC: 320 V / 15 A | Box |
| GTIN (EAN) | 4032248132492 | connection, 3.50 mm, Number of poles: 10, 90°, Solder pin length (l): | UL: 300 V / 10 A | |
| Qty. | 42 pc(s). | 1.5 mm, tinned, black, Box | | |
| Type | SL-SMT 3.50/10/90F 3.2S ... | Version | Product data | Packaging |
| Order No. | 1842160000 | PCB plug-in connector, male header, Flange, THT/THR solder | IEC: 320 V / 15 A | Box |
| GTIN (EAN) | 4032248353514 | connection, 3.50 mm, Number of poles: 10, 90°, Solder pin length (l): | UL: 300 V / 10 A | |
| Qty. | 42 pc(s). | 3.2 mm, tinned, black, Box | | |

**OMNIMATE Signal - series BL/SL 3.50
BLZF 3.50/10/180 SN OR BX**

Weidmüller Interface GmbH & Co. KG
 Klingenbergstraße 26
 D-32758 Detmold
 Germany
 Fon: +49 5231 14-0
 Fax: +49 5231 14-292083
 www.weidmueller.com

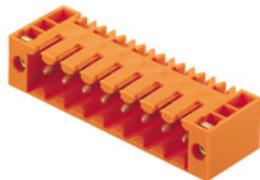
Mating connector (conditionally pluggable)**SL 3.50/90F**

Pin headers for wave soldering in 3.50 mm pitch

- Plugging direction is parallel (90°), straight 180° or angled (135°) to the PCB
- Housing variant: screw flange (F)
- Packed in a cardboard box (BX)
- Pin header can be coded

General ordering data

| Type | SL 3.50/10/90F 3.2SN OR ... | Version | Product data | Packaging |
|------------|-----------------------------|--|------------------|-----------|
| Order No. | 1607120000 | PCB plug-in connector, male header, Flange, THT solder connection, | IEC: / 17 A | Box |
| GTIN (EAN) | 4008190079710 | 3.50 mm, Number of poles: 10, 90°, Solder pin length (l): 3.2 mm, | UL: 300 V / 10 A | |
| Qty. | 50 pc(s). | tinned, orange, Box | | |
| Type | SL 3.50/10/90F 4.5SN OR ... | Version | Product data | Packaging |
| Order No. | 1618130000 | PCB plug-in connector, male header, Flange, THT solder connection, | IEC: / 17 A | Box |
| GTIN (EAN) | 4008190116941 | 3.50 mm, Number of poles: 10, 90°, Solder pin length (l): 4.5 mm, | UL: 300 V / 10 A | |
| Qty. | 50 pc(s). | tinned, orange, Box | | |
| Type | SL 3.50/10/90F 4.5 SN B ... | Version | Product data | Packaging |
| Order No. | 1615600000 | PCB plug-in connector, male header, Flange, THT solder connection, | IEC: / 17 A | Box |
| GTIN (EAN) | 4008190057633 | 3.50 mm, Number of poles: 10, 90°, Solder pin length (l): 4.5 mm, | UL: 300 V / 10 A | |
| Qty. | 50 pc(s). | tinned, black, Box | | |
| Type | SL 3.50/10/90F 3.2SN BK ... | Version | Product data | Packaging |
| Order No. | 1681720000 | PCB plug-in connector, male header, Flange, THT solder connection, | IEC: / 17 A | Box |
| GTIN (EAN) | 4008190472528 | 3.50 mm, Number of poles: 10, 90°, Solder pin length (l): 3.2 mm, | UL: 300 V / 10 A | |
| Qty. | 50 pc(s). | tinned, black, Box | | |
| Type | SL 3.50/10/90F 3.2SN DK ... | Version | Product data | Packaging |
| Order No. | 1620140000 | PCB plug-in connector, male header, Flange, THT solder connection, | IEC: / 17 A | Box |
| GTIN (EAN) | 4008190152437 | 3.50 mm, Number of poles: 10, 90°, Solder pin length (l): 3.2 mm, | UL: 300 V / 10 A | |
| Qty. | 50 pc(s). | tinned, Signal green, Box | | |
| Type | SL 3.50/10/90F 3.2SN GY ... | Version | Product data | Packaging |
| Order No. | 1619930000 | PCB plug-in connector, male header, Flange, THT solder connection, | IEC: / 17 A | Box |
| GTIN (EAN) | 4008190149222 | 3.50 mm, Number of poles: 10, 90°, Solder pin length (l): 3.2 mm, | UL: 300 V / 10 A | |
| Qty. | 50 pc(s). | tinned, Pebble grey, Box | | |

**OMNIMATE Signal - series BL/SL 3.50
BLZF 3.50/10/180 SN OR BX**

Weidmüller Interface GmbH & Co. KG
Klingenbergstraße 26
D-32758 Detmold
Germany
Fon: +49 5231 14-0
Fax: +49 5231 14-292083
www.weidmueller.com

Mating connector (conditionally pluggable)
SL-SMT 3.5/180LF Box

High-temperature-resistant male header, 3.50 mm pitch.

- **Plugging direction parallel (90°), straight 180° or angled (135°) to PCB**
- **Housing variants: closed side (G), screw flange (F), solder flange (LF) or snap-on solder flange (RF)**
- **Optimised for the SMT process**
- **Pin length 3.2 mm universal for all soldering methods**
- **Pin length 1.5 mm optimised for reflow soldering methods**
- **Packed either in a box (BX) or tape-on-reel (RL)**
- **Male header can be coded**

General ordering data

| Type | SL-SMT 3.50/10/180LF 1. ... | Version | Product data | Packaging |
|------------|-----------------------------|---|---------------------------------------|-----------|
| Order No. | 1804780000 | PCB plug-in connector, male header, Solder flange, THT/THR solder connection, 3.50 mm, Number of poles: 10, 180°, Solder pin length (l): 1.5 mm, tinned, black, Box | IEC: 320 V / 15 A UL: 300 V / 10 A | Box |
| GTIN (EAN) | 4032248268566 | | | |
| Qty. | 42 pc(s). | | | |
| Type | SL-SMT 3.50/10/180LF 3. ... | Version | Product data | Packaging |
| Order No. | 1842620000 | PCB plug-in connector, male header, Solder flange, THT/THR solder connection, 3.50 mm, Number of poles: 10, 180°, Solder pin length (l): 3.2 mm, tinned, black, Box | IEC: 320 V / 15 A UL: 300 V / 10 A | Box |
| GTIN (EAN) | 4032248353989 | | | |
| Qty. | 42 pc(s). | | | |

**OMNIMATE Signal - series BL/SL 3.50
BLZF 3.50/10/180 SN OR BX**

Weidmüller Interface GmbH & Co. KG
 Klingenbergstraße 26
 D-32758 Detmold
 Germany
 Fon: +49 5231 14-0
 Fax: +49 5231 14-292083
 www.weidmueller.com

Mating connector (conditionally pluggable)
SL-SMT 3.5/90LF Tape

High-temperature-resistant male header, 3.50 mm pitch.

- **Plugging direction parallel (90°), straight 180° or angled (135°) to PCB**
- **Housing variants: closed side (G), screw flange (F), solder flange (LF) or snap-on solder flange (RF)**
- **Optimised for the SMT process**
- **Pin length 3.2 mm universal for all soldering methods**
- **Pin length 1.5 mm optimised for reflow soldering methods**
- **Packed either in a box (BX) or tape-on-reel (RL)**
- **Male header can be coded**

General ordering data

| Type | SL-SMT 3.50/10/90LF 1.5 ... | Version | Product data | Packaging |
|------------|-----------------------------|---|-------------------|-----------|
| Order No. | 1005180000 | PCB plug-in connector, male header, Solder flange, THT/THR solder connection, 3.50 mm, Number of poles: 10, 90°, Solder pin length (l): 1.5 mm, tinned, black, Tape | IEC: 320 V / 15 A | Tape |
| GTIN (EAN) | 4032248704545 | | UL: 300 V / 10 A | |
| Qty. | 385 pc(s). | | | |

**OMNIMATE Signal - series BL/SL 3.50
BLZF 3.50/10/180 SN OR BX**

Weidmüller Interface GmbH & Co. KG
Klingenbergstraße 26
D-32758 Detmold
Germany
Fon: +49 5231 14-0
Fax: +49 5231 14-292083
www.weidmueller.com

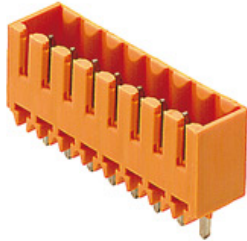
Mating connector (fully pluggable)**SL 3.50/180G**

Pin headers for wave soldering in 3.50 mm pitch

- Plugging direction is parallel (90°), straight 180° or angled (135°) to the PCB
- Housing variant: screw flange (F)
- Packed in a cardboard box (BX)
- Pin header can be coded

General ordering data

| Type | SL 3.50/10/180G 3.2SN O ... | Version | Product data | Packaging |
|------------|-----------------------------|---|-------------------|-----------|
| Order No. | 1604550000 | PCB plug-in connector, male header, closed side, THT solder | IEC: 320 V / 17 A | Box |
| GTIN (EAN) | 4008190111663 | connection, 3.50 mm, Number of poles: 10, 180°, Solder pin length | UL: 300 V / 10 A | |
| Qty. | 50 pc(s). | (I): 3.2 mm, tinned, orange, Box | | |
| Type | SL 3.50/10/180G 4.5SN O ... | Version | Product data | Packaging |
| Order No. | 1604700000 | PCB plug-in connector, male header, closed side, THT solder | IEC: 320 V / 17 A | Box |
| GTIN (EAN) | 4008190058616 | connection, 3.50 mm, Number of poles: 10, 180°, Solder pin length | UL: 300 V / 10 A | |
| Qty. | 50 pc(s). | (I): 4.5 mm, tinned, orange, Box | | |
| Type | SL 3.50/10/180G 4.5SN B ... | Version | Product data | Packaging |
| Order No. | 1616080000 | PCB plug-in connector, male header, closed side, THT solder | IEC: 320 V / 17 A | Box |
| GTIN (EAN) | 4008190065973 | connection, 3.50 mm, Number of poles: 10, 180°, Solder pin length | UL: 300 V / 10 A | |
| Qty. | 50 pc(s). | (I): 4.5 mm, tinned, black, Box | | |

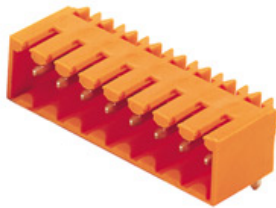
SL 3.50/90G

Pin headers for wave soldering in 3.50 mm pitch

- Plugging direction is parallel (90°), straight 180° or angled (135°) to the PCB
- Housing variant: screw flange (F)
- Packed in a cardboard box (BX)
- Pin header can be coded

General ordering data

| Type | SL 3.50/12/90G 3.2SN DK ... | Version | Product data | Packaging |
|------------|-----------------------------|---|------------------|-----------|
| Order No. | 1744190000 | PCB plug-in connector, male header, closed side, THT solder | IEC: / 17 A | Box |
| GTIN (EAN) | 4008190981716 | connection, 3.50 mm, Number of poles: 12, 90°, Solder pin length (I): | UL: 300 V / 10 A | |
| Qty. | 50 pc(s). | 3.2 mm, tinned, Signal green, Box | | |
| Type | SL 3.50/10/90G 3.2SN OR ... | Version | Product data | Packaging |
| Order No. | 1605150000 | PCB plug-in connector, male header, closed side, THT solder | IEC: / 17 A | Box |
| GTIN (EAN) | 4008190183998 | connection, 3.50 mm, Number of poles: 10, 90°, Solder pin length (I): | UL: 300 V / 10 A | |
| Qty. | 50 pc(s). | 3.2 mm, tinned, orange, Box | | |
| Type | SL 3.50/10/90G 3.2SN GY ... | Version | Product data | Packaging |
| Order No. | 1619540000 | PCB plug-in connector, male header, closed side, THT solder | IEC: / 17 A | Box |
| GTIN (EAN) | 4008190142254 | connection, 3.50 mm, Number of poles: 10, 90°, Solder pin length (I): | UL: 300 V / 10 A | |
| Qty. | 50 pc(s). | 3.2 mm, tinned, Pebble grey, Box | | |

**OMNIMATE Signal - series BL/SL 3.50
BLZF 3.50/10/180 SN OR BX**

Weidmüller Interface GmbH & Co. KG
Klingenbergstraße 26
D-32758 Detmold
Germany
Fon: +49 5231 14-0
Fax: +49 5231 14-292083
www.weidmueller.com

Mating connector (fully pluggable)

| Type | SL 3.50/10/90G 3.2SN BK ... | Version | Product data | Packaging |
|------------|-----------------------------|---|------------------|-----------|
| Order No. | 1689780000 | PCB plug-in connector, male header, closed side, THT solder | IEC: / 17 A | Box |
| GTIN (EAN) | 4008190860738 | connection, 3.50 mm, Number of poles: 10, 90°, Solder pin length (l): | UL: 300 V / 10 A | |
| Qty. | 50 pc(s). | 3.2 mm, tinned, black, Box | | |
| Type | SL 3.50/10/90G 3.2SN DK ... | Version | Product data | Packaging |
| Order No. | 1606970000 | PCB plug-in connector, male header, closed side, THT solder | IEC: / 17 A | Box |
| GTIN (EAN) | 4008190075095 | connection, 3.50 mm, Number of poles: 10, 90°, Solder pin length (l): | UL: 300 V / 10 A | |
| Qty. | 50 pc(s). | 3.2 mm, tinned, Signal green, Box | | |
| Type | SL 3.50/10/90G 4.5 SN O ... | Version | Product data | Packaging |
| Order No. | 1605300000 | PCB plug-in connector, male header, closed side, THT solder | IEC: / 17 A | Box |
| GTIN (EAN) | 4008190101411 | connection, 3.50 mm, Number of poles: 10, 90°, Solder pin length (l): | UL: 300 V / 10 A | |
| Qty. | 50 pc(s). | 4.5 mm, tinned, orange, Box | | |
| Type | SL 3.50/10/90G 4.5SN BK ... | Version | Product data | Packaging |
| Order No. | 1615470000 | PCB plug-in connector, male header, closed side, THT solder | IEC: / 17 A | Box |
| GTIN (EAN) | 4008190055677 | connection, 3.50 mm, Number of poles: 10, 90°, Solder pin length (l): | UL: 300 V / 10 A | |
| Qty. | 50 pc(s). | 4.5 mm, tinned, black, Box | | |

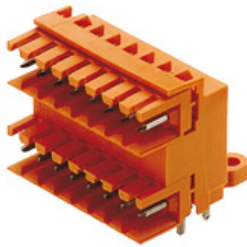
SLD 3.50/90

Two-tier pin header for wave soldering in 3.50 mm pitch. The connector is available in open, closed and flange versions. The male connectors provide space for labelling and can be coded. Packed in a cardboard box.

General ordering data

| Type | SLD 3.50/20/90 3.2SN OR ... | Version | Product data | Packaging |
|------------|-----------------------------|---|---------------------|-----------|
| Order No. | 1633430000 | PCB plug-in connector, male header, open side, THT solder | IEC: 200 V / 10.5 A | Box |
| GTIN (EAN) | 4008190257880 | connection, 3.50 mm, Number of poles: 20, 90°, Solder pin length (l): | UL: 300 V / 8 A | |
| Qty. | 20 pc(s). | 3.2 mm, tinned, orange, Box | | |

**OMNIMATE Signal - series BL/SL 3.50
BLZF 3.50/10/180 SN OR BX**

Weidmüller Interface GmbH & Co. KG
Klingenbergstraße 26
D-32758 Detmold
Germany
Fon: +49 5231 14-0
Fax: +49 5231 14-292083
www.weidmueller.com

Mating connector (fully pluggable)
SL-SMT 3.5/90G Tray

High-temperature-resistant male header, 3.50 mm pitch.

- **Plugging direction parallel (90°), straight 180° or angled (135°) to PCB**
- **Housing variants: closed side (G), screw flange (F), solder flange (LF) or snap-on solder flange (RF)**
- **Optimised for the SMT process**
- **Pin length 3.2 mm universal for all soldering methods**
- **Pin length 1.5 mm optimised for reflow soldering methods**
- **Packed either in a box (BX) or tape-on-reel (RL)**
- **Male header can be coded**

General ordering data

| Type | SL-SMT 3.50/10/90G 1.5S ... | Version | Product data | Packaging |
|------------|-----------------------------|---|-------------------|-----------|
| Order No. | 1761623001 | PCB plug-in connector, male header, closed side, THT/THR solder connection, 3.50 mm, Number of poles: 10, 90°, Solder pin length (l): 1.5 mm, tinned, black, Tray | IEC: 320 V / 15 A | Tray |
| GTIN (EAN) | 4032248133895 | | UL: 300 V / 10 A | |
| Qty. | 42 pc(s). | | | |

SL-SMT 3.5/90G Tape

High-temperature-resistant male header, 3.50 mm pitch.

- **Plugging direction parallel (90°), straight 180° or angled (135°) to PCB**
- **Housing variants: closed side (G), screw flange (F), solder flange (LF) or snap-on solder flange (RF)**
- **Optimised for the SMT process**
- **Pin length 3.2 mm universal for all soldering methods**
- **Pin length 1.5 mm optimised for reflow soldering methods**
- **Packed either in a box (BX) or tape-on-reel (RL)**
- **Male header can be coded**

General ordering data

| Type | SL-SMT 3.50/10/90G 1.5S ... | Version | Product data | Packaging |
|------------|-----------------------------|---|-------------------|-----------|
| Order No. | 1761624001 | PCB plug-in connector, male header, closed side, THT/THR solder connection, 3.50 mm, Number of poles: 10, 90°, Solder pin length (l): 1.5 mm, tinned, black, Tape | IEC: 320 V / 15 A | Tape |
| GTIN (EAN) | 4032248136063 | | UL: 300 V / 10 A | |
| Qty. | 385 pc(s). | | | |

**OMNIMATE Signal - series BL/SL 3.50
BLZF 3.50/10/180 SN OR BX**

Weidmüller Interface GmbH & Co. KG
Klingenbergstraße 26
D-32758 Detmold
Germany
Fon: +49 5231 14-0
Fax: +49 5231 14-292083
www.weidmueller.com

Mating connector (fully pluggable)
SL-THR 3.5/135F

High-temperature-resistant male header, 3.50 mm pitch.

- **Plugging direction parallel (90°), straight 180° or angled (135°) to PCB**
- **Housing variants: closed side (G), screw flange (F), solder flange (LF) or snap-on solder flange (RF)**
- **Optimised for the SMT process**
- **Pin length 3.2 mm universal for all soldering methods**
- **Pin length 1.5 mm optimised for reflow soldering methods**
- **Packed either in a box (BX) or tape-on-reel (RL)**
- **Male header can be coded**

General ordering data

| Type | SL-SMT 3.50/10/135F 3.2 ... | Version | Product data | Packaging |
|------------|-----------------------------|--|---------------------------------------|-----------|
| Order No. | 1003590000 | PCB plug-in connector, male header, Flange, THT/THR solder connection, 3.50 mm, Number of poles: 10, 135°, Solder pin length (l): 3.2 mm, tinned, black, Box | IEC: 320 V / 15 A UL: 300 V / 10 A | Box |
| GTIN (EAN) | 4032248700219 | | | |
| Qty. | 42 pc(s). | | | |

SLD 3.50V/90G

Double-level, staggered pin header for wave soldering at 3.50 mm pitch. They are available in closed and flanged versions. The male connectors provide space for labelling and can be coded.

General ordering data

| Type | SLD 3.50V/20/90G 3.2SN ... | Version | Product data | Packaging |
|------------|----------------------------|---|--|-----------|
| Order No. | 1642280000 | PCB plug-in connector, male header, closed side, THT solder connection, 3.50 mm, Number of poles: 20, 90°, Solder pin length (l): 3.2 mm, tinned, orange, Box | IEC: 200 V / 10.5 A UL: 300 V / 8 A | Box |
| GTIN (EAN) | 4008190280802 | | | |
| Qty. | 20 pc(s). | | | |

**OMNIMATE Signal - series BL/SL 3.50
BLZF 3.50/10/180 SN OR BX**

Weidmüller Interface GmbH & Co. KG
Klingenbergstraße 26
D-32758 Detmold
Germany
Fon: +49 5231 14-0
Fax: +49 5231 14-292083
www.weidmueller.com

Mating connector (fully pluggable)
SL-SMT 3.5/180G Tape

High-temperature-resistant male header, 3.50 mm pitch.

- **Plugging direction parallel (90°), straight 180° or angled (135°) to PCB**
- **Housing variants: closed side (G), screw flange (F), solder flange (LF) or snap-on solder flange (RF)**
- **Optimised for the SMT process**
- **Pin length 3.2 mm universal for all soldering methods**
- **Pin length 1.5 mm optimised for reflow soldering methods**
- **Packed either in a box (BX) or tape-on-reel (RL)**
- **Male header can be coded**

General ordering data

| Type | SL-SMT 3.50/10/180G 1.5 ... | Version | Product data | Packaging |
|------------|-----------------------------|--|---------------------------------------|-----------|
| Order No. | 1753064001 | PCB plug-in connector, male header, closed side, THT/THR solder connection, 3.50 mm, Number of poles: 10, 180°, Solder pin length (l): 1.5 mm, tinned, black, Tape | IEC: 320 V / 15 A UL: 300 V / 10 A | Tape |
| GTIN (EAN) | 4032248135660 | | | |
| Qty. | 265 pc(s). | | | |

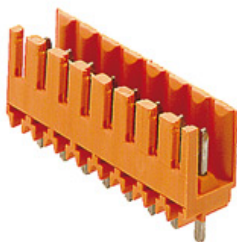
SL 3.50/180

Pin headers for wave soldering in 3.50 mm pitch

- **Plugging direction is parallel (90°), straight 180° or angled (135°) to the PCB**
- **Housing variant: screw flange (F)**
- **Packed in a cardboard box (BX)**
- **Pin header can be coded**

General ordering data

| Type | SL 3.50/10/180 3.2SN OR ... | Version | Product data | Packaging |
|------------|-----------------------------|--|---------------------------------------|-----------|
| Order No. | 1604850000 | PCB plug-in connector, male header, open side, THT solder connection, 3.50 mm, Number of poles: 10, 180°, Solder pin length (l): 3.2 mm, tinned, orange, Box | IEC: 320 V / 17 A UL: 300 V / 10 A | Box |
| GTIN (EAN) | 4008190096649 | | | |
| Qty. | 50 pc(s). | | | |

**OMNIMATE Signal - series BL/SL 3.50
BLZF 3.50/10/180 SN OR BX**

Weidmüller Interface GmbH & Co. KG
Klingenbergstraße 26
D-32758 Detmold
Germany
Fon: +49 5231 14-0
Fax: +49 5231 14-292083
www.weidmueller.com

Mating connector (fully pluggable)
SL-SMT 3.5/180G Tray

High-temperature-resistant male header, 3.50 mm pitch.

- **Plugging direction parallel (90°), straight 180° or angled (135°) to PCB**
- **Housing variants: closed side (G), screw flange (F), solder flange (LF) or snap-on solder flange (RF)**
- **Optimised for the SMT process**
- **Pin length 3.2 mm universal for all soldering methods**
- **Pin length 1.5 mm optimised for reflow soldering methods**
- **Packed either in a box (BX) or tape-on-reel (RL)**
- **Male header can be coded**

General ordering data

| Type | SL-SMT 3.50/10/180G 1.5 ... | Version | Product data | Packaging |
|------------|-----------------------------|--|---------------------------------------|-----------|
| Order No. | 1753063001 | PCB plug-in connector, male header, closed side, THT/THR solder connection, 3.50 mm, Number of poles: 10, 180°, Solder pin length (l): 1.5 mm, tinned, black, Tray | IEC: 320 V / 15 A UL: 300 V / 10 A | Tray |
| GTIN (EAN) | 4032248132799 | | | |
| Qty. | 42 pc(s). | | | |

SL-SMT 3.5/90G Box

High-temperature-resistant male header, 3.50 mm pitch.

- **Plugging direction parallel (90°), straight 180° or angled (135°) to PCB**
- **Housing variants: closed side (G), screw flange (F), solder flange (LF) or snap-on solder flange (RF)**
- **Optimised for the SMT process**
- **Pin length 3.2 mm universal for all soldering methods**
- **Pin length 1.5 mm optimised for reflow soldering methods**
- **Packed either in a box (BX) or tape-on-reel (RL)**
- **Male header can be coded**

General ordering data

| Type | SL-SMT 3.50/10/90G 1.5S ... | Version | Product data | Packaging |
|------------|-----------------------------|--|---------------------------------------|-----------|
| Order No. | 1761622001 | PCB plug-in connector, male header, closed side, THT/THR solder connection, 3.50 mm, Number of poles: 10, 90°, Solder pin length (l): 1.5 mm, tinned, black, Box | IEC: 320 V / 15 A UL: 300 V / 10 A | Box |
| GTIN (EAN) | 4032248132218 | | | |
| Qty. | 50 pc(s). | | | |

**OMNIMATE Signal - series BL/SL 3.50
BLZF 3.50/10/180 SN OR BX**

Weidmüller Interface GmbH & Co. KG
Klingenbergstraße 26
D-32758 Detmold
Germany
Fon: +49 5231 14-0
Fax: +49 5231 14-292083
www.weidmueller.com

Mating connector (fully pluggable)

| Type | SL-SMT 3.50/10/90G 3.2S ... | Version | Product data | Packaging |
|------------|-----------------------------|---|-------------------|-----------|
| Order No. | 1841710000 | PCB plug-in connector, male header, closed side, THT/THR solder | IEC: 320 V / 15 A | Box |
| GTIN (EAN) | 4032248353064 | connection, 3.50 mm, Number of poles: 10, 90°, Solder pin length (l): | UL: 300 V / 10 A | |
| Qty. | 50 pc(s). | 3.2 mm, tinned, black, Box | | |

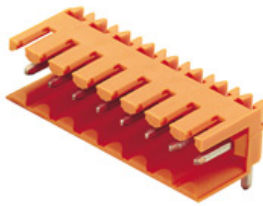
SL 3.50/90

Pin headers for wave soldering in 3.50 mm pitch

- Plugging direction is parallel (90°), straight 180° or angled (135°) to the PCB
- Housing variant: screw flange (F)
- Packed in a cardboard box (BX)
- Pin header can be coded

General ordering data

| Type | SL 3.50/10/90 3.2SN OR ... | Version | Product data | Packaging |
|------------|-----------------------------|---|-------------------|-----------|
| Order No. | 1597290000 | PCB plug-in connector, male header, open side, THT solder | IEC: 320 V / 17 A | Box |
| GTIN (EAN) | 4008190165277 | connection, 3.50 mm, Number of poles: 10, 90°, Solder pin length (l): | UL: 300 V / 10 A | |
| Qty. | 50 pc(s). | 3.2 mm, tinned, orange, Box | | |
| Type | SL 3.50/10/90 3.2SN GY ... | Version | Product data | Packaging |
| Order No. | 1619150000 | PCB plug-in connector, male header, open side, THT solder | IEC: 320 V / 17 A | Box |
| GTIN (EAN) | 4008190134709 | connection, 3.50 mm, Number of poles: 10, 90°, Solder pin length (l): | UL: 300 V / 10 A | |
| Qty. | 50 pc(s). | 3.2 mm, tinned, Pebble grey, Box | | |
| Type | SL 3.50/10/90 4.5SN OR ... | Version | Product data | Packaging |
| Order No. | 1605450000 | PCB plug-in connector, male header, open side, THT solder | IEC: 320 V / 17 A | Box |
| GTIN (EAN) | 4008190138363 | connection, 3.50 mm, Number of poles: 10, 90°, Solder pin length (l): | UL: 300 V / 10 A | |
| Qty. | 50 pc(s). | 4.5 mm, tinned, orange, Box | | |
| Type | SL 3.50/10/90 4.5SN BK ... | Version | Product data | Packaging |
| Order No. | 1615360000 | PCB plug-in connector, male header, open side, THT solder | IEC: 320 V / 17 A | Box |
| GTIN (EAN) | 4008190053024 | connection, 3.50 mm, Number of poles: 10, 90°, Solder pin length (l): | UL: 300 V / 10 A | |
| Qty. | 50 pc(s). | 4.5 mm, tinned, black, Box | | |
| Type | SL 3.50/10/90 3.2SN DKG ... | Version | Product data | Packaging |
| Order No. | 1606850000 | PCB plug-in connector, male header, open side, THT solder | IEC: 320 V / 17 A | Box |
| GTIN (EAN) | 4008190154721 | connection, 3.50 mm, Number of poles: 10, 90°, Solder pin length (l): | UL: 300 V / 10 A | |
| Qty. | 50 pc(s). | 3.2 mm, tinned, Signal green, Box | | |
| Type | SL 3.50/10/90 3.2SN BK ... | Version | Product data | Packaging |
| Order No. | 1663790000 | PCB plug-in connector, male header, open side, THT solder | IEC: 320 V / 17 A | Box |
| GTIN (EAN) | 4008190420475 | connection, 3.50 mm, Number of poles: 10, 90°, Solder pin length (l): | UL: 300 V / 10 A | |
| Qty. | 50 pc(s). | 3.2 mm, tinned, black, Box | | |

**OMNIMATE Signal - series BL/SL 3.50
BLZF 3.50/10/180 SN OR BX**

Weidmüller Interface GmbH & Co. KG
Klingenbergstraße 26
D-32758 Detmold
Germany
Fon: +49 5231 14-0
Fax: +49 5231 14-292083
www.weidmueller.com

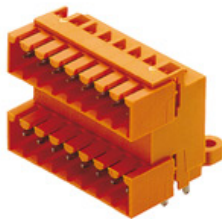
Mating connector (fully pluggable)
SLD 3.50/90G

Two-tier pin header for wave soldering in 3.50 mm pitch. The connector is available in open, closed and flange versions. The male connectors provide space for labelling and can be coded. Packed in a cardboard box.

General ordering data

| Type | SLD 3.50/20/90G 3.2SN D ... | Version | Product data | Packaging |
|------------|-----------------------------|---|--|-----------|
| Order No. | 1674940000 | PCB plug-in connector, male header, closed side, THT solder connection, 3.50 mm, Number of poles: 20, 90°, Solder pin length (l): 3.2 mm, tinned, Signal green, Box | IEC: 200 V / 10.5 A UL: 300 V / 8 A | Box |
| GTIN (EAN) | 4008190445638 | | | |
| Qty. | 20 pc(s). | | | |
| Type | SLD 3.50/20/90G 3.2SN O ... | Version | Product data | Packaging |
| Order No. | 1633660000 | PCB plug-in connector, male header, closed side, THT solder connection, 3.50 mm, Number of poles: 20, 90°, Solder pin length (l): 3.2 mm, tinned, orange, Box | IEC: 200 V / 10.5 A UL: 300 V / 8 A | Box |
| GTIN (EAN) | 4008190258115 | | | |
| Qty. | 20 pc(s). | | | |
| Type | SLD 3.50/20/90G 4.5SN B ... | Version | Product data | Packaging |
| Order No. | 1634350000 | PCB plug-in connector, male header, closed side, THT solder connection, 3.50 mm, Number of poles: 20, 90°, Solder pin length (l): 4.5 mm, tinned, black, Box | IEC: 200 V / 10.5 A UL: 300 V / 8 A | Box |
| GTIN (EAN) | 4008190258801 | | | |
| Qty. | 20 pc(s). | | | |

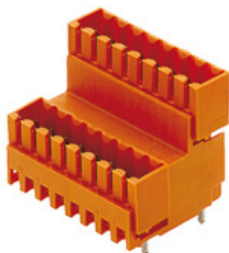
SLD 3.50V/180G

Double-level, staggered pin header for wave soldering at 3.50 mm pitch. They are available in closed and flanged versions. The male connectors provide space for labelling and can be coded.

General ordering data

| Type | SLD 3.50V/20/180G 3.2SN ... | Version | Product data | Packaging |
|------------|-----------------------------|--|--|-----------|
| Order No. | 1641150000 | PCB plug-in connector, male header, closed side, THT solder connection, 3.50 mm, Number of poles: 20, 180°, Solder pin length (l): 3.2 mm, tinned, orange, Box | IEC: 200 V / 10.5 A UL: 300 V / 8 A | Box |
| GTIN (EAN) | 4008190279554 | | | |
| Qty. | 20 pc(s). | | | |

OMNIMATE Signal - series BL/SL 3.50 BLZF 3.50/10/180 SN OR BX

Weidmüller Interface GmbH & Co. KG
 Klingenbergstraße 26
 D-32758 Detmold
 Germany
 Fon: +49 5231 14-0
 Fax: +49 5231 14-292083
 www.weidmueller.com

Accessories

Strain reliefs



For frequent load changes: the "trailer coupling" for plug-in connectors.

The strain relief can do more than just relieve the strain on conductors:

Simply clip onto the plug and

- bundle conductors
- guide cables
- use as a connection and disconnection aid

No damage to the connecting points, clear, tidy wiring and easy to handle.

User advantages: permanent heavy-duty connections for harsh industrial environments and convenient operation ensure improved system availability.

General ordering data

| Type | BL 3.50 ZE08 BK BX | Version | Product data | Packaging |
|------------|----------------------------|---------|--|-----------|
| Order No. | 1627830000 | | PCB plug-in connector, Accessories, Strain relief, black, Number of | Box |
| GTIN (EAN) | 4008190202576 | | poles: 8 | |
| Qty. | 50 pc(s). | | | |
| Type | BL 3.50 ZE03 BK BX | Version | Product data | Packaging |
| Order No. | 1627820000 | | PCB plug-in connector, Accessories, Strain relief, black, Number of | Box |
| GTIN (EAN) | 4008190202552 | | poles: 3 | |
| Qty. | 50 pc(s). | | | |
| Type | BL 3.50 ZE03 OR BX | Version | Product data | Packaging |
| Order No. | 1629680000 | | PCB plug-in connector, Accessories, Strain relief, orange, Number of | Box |
| GTIN (EAN) | 4008190202569 | | poles: 3 | |
| Qty. | 50 pc(s). | | | |
| Type | BL 3.50 ZE08 OR BX | Version | Product data | Packaging |
| Order No. | 1629690000 | | PCB plug-in connector, Accessories, Strain relief, orange, Number of | Box |
| GTIN (EAN) | 4008190202583 | | poles: 8 | |
| Qty. | 50 pc(s). | | | |

OMNIMATE Signal - series BL/SL 3.50 BLZF 3.50/10/180 SN OR BX

Weidmüller Interface GmbH & Co. KG
 Klingenbergstraße 26
 D-32758 Detmold
 Germany
 Fon: +49 5231 14-0
 Fax: +49 5231 14-292083
 www.weidmueller.com

Accessories

Coding elements



**Only connects what is supposed to be connected:
the right connection at the right place.**

Coding elements and locking devices clearly assign connecting elements during the manufacturing process and operation

The coding elements and locking devices are inserted prior to assembly or during the cable assembly phase. The Weidmüller alternative: configure online using the variant configurator to precode prior to delivery.

Incorrect assembly on the circuit board and incorrect plugging of connecting elements is no longer possible. The advantage: no troubleshooting during manufacture and no operational errors by the user.

General ordering data

| Type | BL SL 3.5 KO SW | Version | Product data | Packaging |
|------------|----------------------------|--|--------------|-----------|
| Order No. | 1610100000 | PCB plug-in connector, Accessories, Coding element, black, Number | | Box |
| GTIN (EAN) | 4008190187637 | of poles: 1 | | |
| Qty. | 100 pc(s). | | | |
| Type | BL SL 3.5 KO OR | Version | Product data | Packaging |
| Order No. | 1693430000 | PCB plug-in connector, Accessories, Coding element, orange, Number | | Box |
| GTIN (EAN) | 4008190867447 | of poles: 1 | | |
| Qty. | 100 pc(s). | | | |

SHOWN:BLZF 3.50/04/180

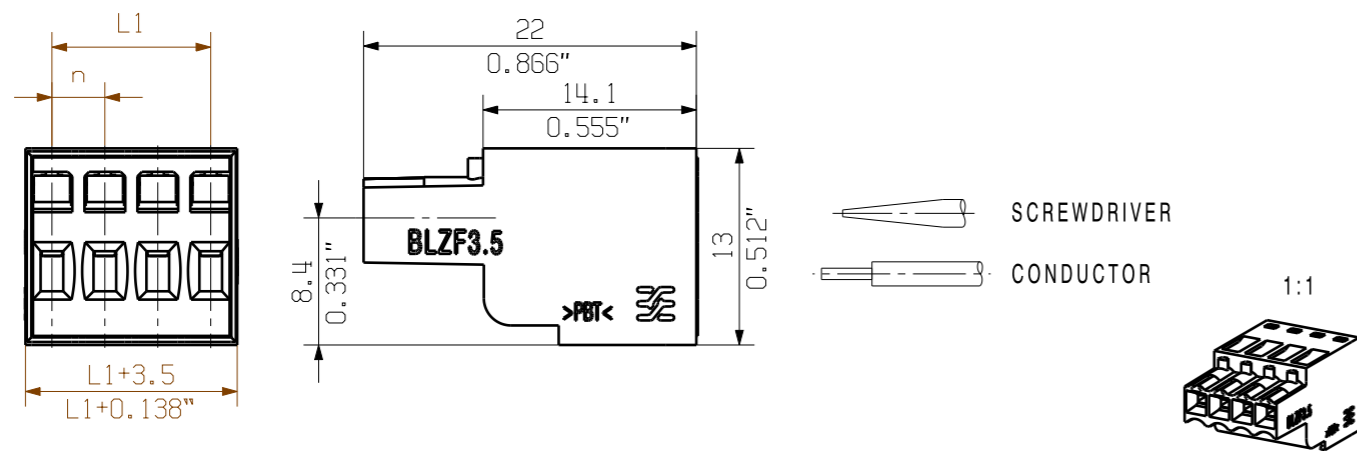

SHOWN:BLZF 3.50/04/180F

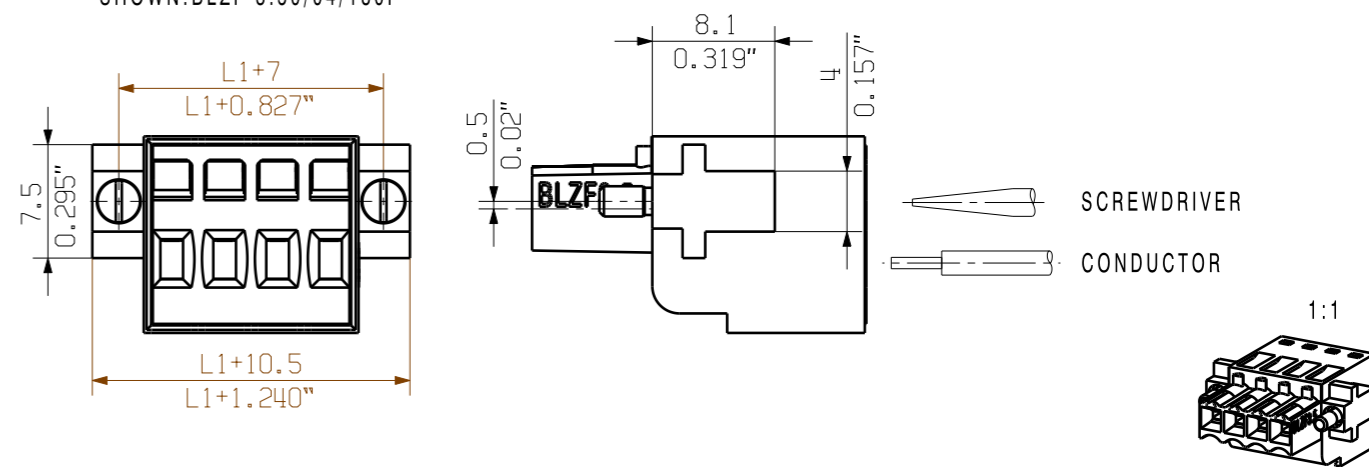

SHOWN:BLZF 3.50/04/180/SO

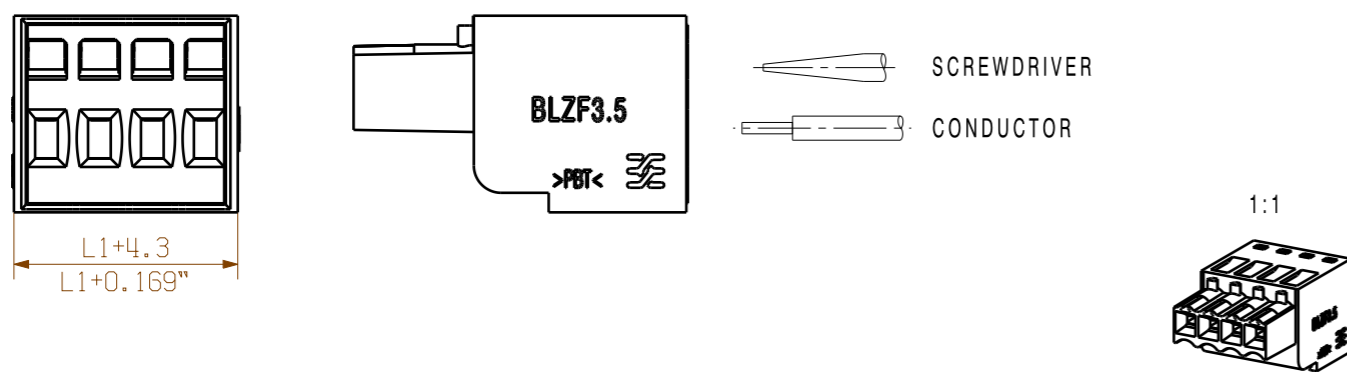

SHOWN:BLZF 3.50/04/180LR REDESIGN



SHOWN:BLZF 3.50/04/180LR

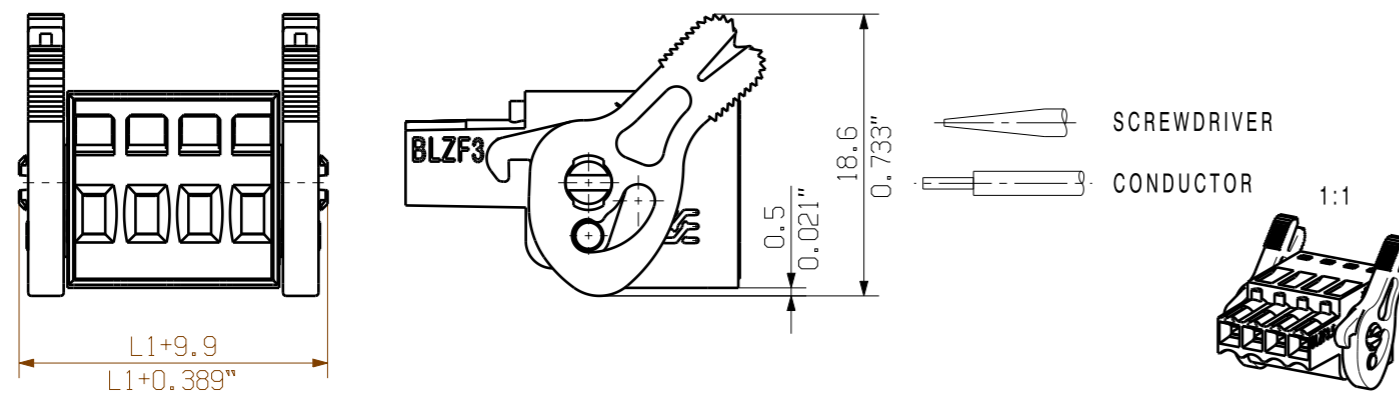

SHOWN:BLZF 3.50/04/180LH

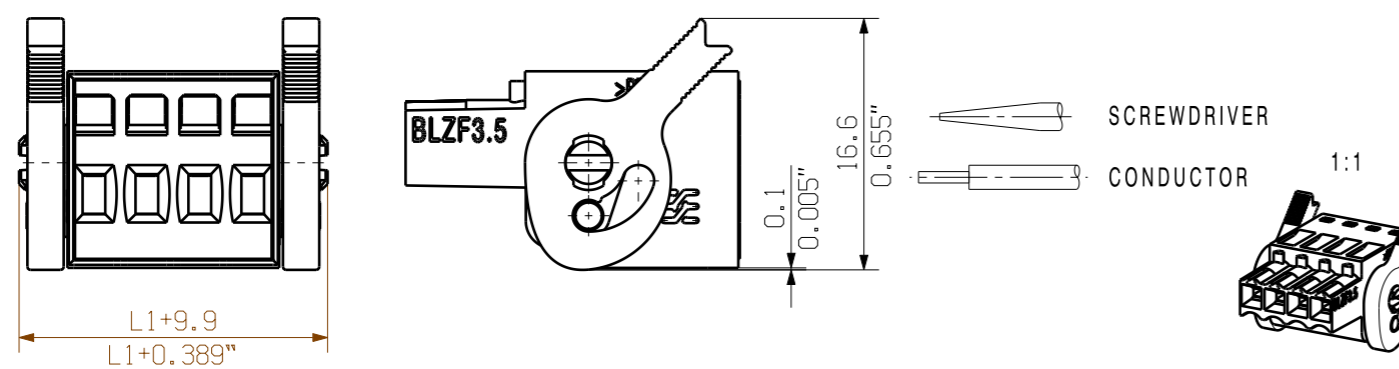

ALLGEMEINGUELTIGE KUNDENZEICHNUNG, AKTUELLER STAND NUR AUF ANFRAGE
GENERAL CUSTOMER DRAWING, TOPICAL VERSION ONLY IF REQUIRED

For the mounting of PCBs, it should be noted that the rated data given in the catalogue relates only to the connection elements. The necessary creepage and clearance paths must be observed in connection with the respective applicant in accordance with VDE 0110. The current-carrying capacity and pitch tolerance is to be determined according to DIN IEC 326 part 3 very fine.

Weidmüller connectors are tested to the DIN VDE 0627 standard, and are valid for its field of application. Provided that the connectors are used to the intended purpose, all requirements with respect to the occurring of electrical, mechanical, thermic and corrosive stress will be satisfied.

| POLZAHL POLES | L1 (mm) | L1 (inch) |
|------------------|------------|--------------|
| 24 | 80.5 | 3.169 |
| 23 | 77.0 | 3.032 |
| 22 | 73.5 | 2.894 |
| 21 | 70.0 | 2.756 |
| 20 | 66.5 | 2.618 |
| 19 | 63.0 | 2.480 |
| 18 | 59.5 | 2.343 |
| 17 | 56.0 | 2.205 |
| 16 | 52.5 | 2.067 |
| 15 | 49.0 | 1.929 |
| 14 | 45.5 | 1.791 |
| 13 | 42.0 | 1.654 |
| 12 | 38.5 | 1.516 |
| 11 | 35.0 | 1.378 |
| 10 | 31.5 | 1.240 |
| 9 | 28.0 | 1.102 |
| 8 | 24.5 | 0.965 |
| 7 | 21.0 | 0.827 |
| 6 | 17.5 | 0.689 |
| 5 | 14.0 | 0.551 |
| 4 | 10.5 | 0.413 |
| 3 | 7.0 | 0.276 |
| 2 | 3.5 | 0.138 |

| | | | |
|---|---------------------------------|---|-------------------------|
| | DIN ISO 2768-m | Cat.no.: . | |
| | 93783/5 24.11.17 HELIS_MA 02 | 3 23142 20 Drawing no. Issue no. | |
| Modification | | Sheet 01 of 01 sheets | |
| | Drawn | Date | Name |
| | Responsible | 10.12.2007 | HELIS_MA |
| | Checked | 08.01.2018 | HELIS_MA |
| Supersedes: . | Approved | LANG_T | Product file: BLZF 3.50 |
| Weidmüller | | | |
| BLZF 3.50/././180.. BUCHSENSTECKER FEMALE PLUG | | | |
| | | | 7357 |