

OMNIMATE Signal - series BL/SL 3.50 BL 3.50/24/180LH SN OR BX

Weidmüller Interface GmbH & Co. KG
Klingenbergstraße 26
D-32758 Detmold
Germany
Fon: +49 5231 14-0
Fax: +49 5231 14-292083
www.weidmueller.com

Product image

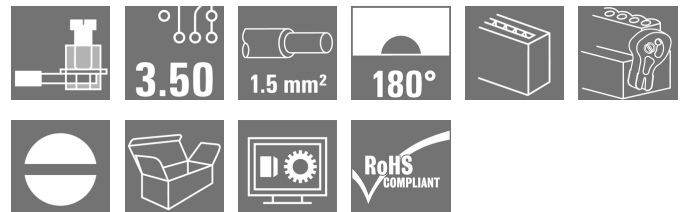

Similar to illustration

Female connectors with clamping yoke screw system for connecting conductors at 3.50 mm pitch. They provide space for labelling and can be coded.

General ordering data

Type	BL 3.50/24/180LH SN OR BX
Order No.	1687870000
Version	PCB plug-in connector, female plug, 3.50 mm, Number of poles: 24, 180°, Clamping yoke connection, Clamping range, max. : 1.5 mm², Box
GTIN (EAN)	4008190853426
Qty.	18 pc(s).
Product data	IEC: 320 V / 17 A / 0.2 - 1.5 mm² UL: 300 V / 10 A / AWG 28 - AWG 14
Packaging	Box

Creation date May 3, 2020 2:07:50 PM CEST

**OMNIMATE Signal - series BL/SL 3.50
BL 3.50/24/180LH SN OR BX**

Weidmüller Interface GmbH & Co. KG
 Klingenbergstraße 26
 D-32758 Detmold
 Germany
 Fon: +49 5231 14-0
 Fax: +49 5231 14-292083
 www.weidmueller.com

Technical data**Dimensions and weights**

Width	90.5 mm	Width (inches)	3.563 inch
Height	14.9 mm	Height (inches)	0.587 inch
Depth	29.5 mm	Depth (inches)	1.161 inch
Net weight	23.1 g		

System Parameters

Product family	OMNIMATE Signal - series BL/SL 3.50	Type of connection	Field connection
Wire connection method	Clamping yoke connection	Pitch in mm (P)	3.5 mm
Pitch in inches (P)	0.138 inch	Conductor outlet direction	180°
Number of poles	24	L1 in mm	80.5 mm
L1 in inches	3.169 inch	Number of rows	1
Pin series quantity	1	Rated cross-section	1.5 mm ²
Touch-safe protection acc. to DIN VDE 57 106	Safe from finger touch	Touch-safe protection acc. to DIN VDE 0470	IP 20
Volume resistance	≤ 5mΩ	Can be coded	Yes
Stripping length	6 mm	Tightening torque, min.	0.2 Nm
Tightening torque, max.	0.25 Nm	Clamping screw	M 2
Screwdriver blade	0.4 x 2.5	Screwdriver blade standard	DIN 5264
Plugging cycles	25	Plugging force/pole, max.	7 N
Pulling force/pole, max.	5 N		

Material data

Insulating material	PBT	Colour	orange
Colour chart (similar)	RAL 2000	Insulating material group	IIIa
Comparative Tracking Index (CTI)	≥ 200	Insulation strength	≥ 10 ⁸ Ω
UL 94 flammability rating	V-0	GWFI	960 °C
Contact material	Copper alloy	Contact surface	tinned
Layer structure of plug contact	4-8 μm Sn hot-dip tinned	Storage temperature, min.	-25 °C
Storage temperature, max.	50 °C	Max. relative humidity during storage	70 %
Operating temperature, min.	-50 °C	Operating temperature, max.	100 °C
Temperature range, installation, min.	-30 °C	Temperature range, installation, max.	100 °C

Conductors suitable for connection

Clamping range, min.	0.08 mm ²
Clamping range, max.	1.5 mm ²
Wire connection cross section AWG, min.	AWG 28
Wire connection cross section AWG, max.	AWG 14
Solid, min. H05(07) V-U	0.2 mm ²
Solid, max. H05(07) V-U	1.5 mm ²
Flexible, min. H05(07) V-K	0.2 mm ²
Flexible, max. H05(07) V-K	1.5 mm ²
w. plastic collar ferrule, DIN 46228 pt 4, 0.2 mm ² min.	
w. plastic collar ferrule, DIN 46228 pt 4, 1.5 mm ² max.	
w. wire end ferrule, DIN 46228 pt 1, 0.2 mm ² min.	
w. wire end ferrule, DIN 46228 pt 1, 1.5 mm ² max.	

Creation date May 3, 2020 2:07:50 PM CEST

OMNIMATE Signal - series BL/SL 3.50
BL 3.50/24/180LH SN OR BX

Weidmüller Interface GmbH & Co. KG
 Klingenbergstraße 26
 D-32758 Detmold
 Germany
 Fon: +49 5231 14-0
 Fax: +49 5231 14-292083
 www.weidmueller.com

Technical data

Plug gauge in accordance with EN 60999 a x b; ø 2.4 mm x 1.5 mm

Clampable conductor	Cross-section for conductor connection	Type	fine-wired
		nominal	0.5 mm ²
wire end ferrule	wire end ferrule	Stripping length	nominal 8 mm
		Recommended wire-end ferrule	H0.5/12 OR
		Stripping length	nominal 6 mm
		Recommended wire-end ferrule	H0.5/6
Cross-section for conductor connection	Type	fine-wired	
	nominal	0.75 mm ²	
wire end ferrule	wire end ferrule	Stripping length	nominal 8 mm
		Recommended wire-end ferrule	H0.75/12 W
		Stripping length	nominal 6 mm
		Recommended wire-end ferrule	H0.75/6
Cross-section for conductor connection	Type	fine-wired	
	nominal	1 mm ²	
wire end ferrule	wire end ferrule	Stripping length	nominal 8 mm
		Recommended wire-end ferrule	H1.0/12 GE
		Stripping length	nominal 6 mm
		Recommended wire-end ferrule	H1.0/6
Cross-section for conductor connection	Type	fine-wired	
	nominal	0.25 mm ²	
wire end ferrule	wire end ferrule	Stripping length	nominal 8 mm
		Recommended wire-end ferrule	H0.25/10 HBL
		Stripping length	nominal 5 mm
		Recommended wire-end ferrule	H0.25/5
Cross-section for conductor connection	Type	fine-wired	
	nominal	0.34 mm ²	
wire end ferrule	wire end ferrule	Stripping length	nominal 8 mm
		Recommended wire-end ferrule	H0.34/10 TK

Reference text The outside diameter of the plastic collar should not be larger than the pitch (P). Length of ferrules is to be chosen depending on the product and the rated voltage.

Max. clamping range 1.5 mm²

Rated data acc. to IEC

tested acc. to standard	IEC 60664-1, IEC 61984	Rated current, min. number of poles (Tu=20°C)	17 A
Rated current, max. number of poles (Tu=20°C)	12 A	Rated current, min. number of poles (Tu=40°C)	14.5 A
Rated current, max. number of poles (Tu=40°C)	10 A	Rated voltage for surge voltage class / pollution degree II/2	320 V
Rated voltage for surge voltage class / pollution degree III/2	160 V	Rated voltage for surge voltage class / pollution degree III/3	160 V
Rated impulse voltage for surge voltage class/ pollution degree II/2	320 V	Rated impulse voltage for surge voltage class/ pollution degree III/2	160 V
Rated impulse voltage for surge voltage class/ contamination degree III/3	160 V	Short-time withstand current resistance	3 x 1s with 100 A

**OMNIMATE Signal - series BL/SL 3.50
BL 3.50/24/180LH SN OR BX**

Weidmüller Interface GmbH & Co. KG
Klingenbergstraße 26
D-32758 Detmold
Germany
Fon: +49 5231 14-0
Fax: +49 5231 14-292083
www.weidmueller.com

Technical data**Rated data acc. to CSA**

Rated voltage (Use group B / CSA)	300 V	Rated voltage (Use group D / CSA)	300 V
Rated current (Use group B / CSA)	10 A	Rated current (Use group D / CSA)	10 A
Wire cross-section, AWG, min.	AWG 28	Wire cross-section, AWG, max.	AWG 14

Rated data acc. to UL 1059

Institute (UR)		Certificate No. (UR)	E60693
Rated voltage (Use group B / UL 1059)	300 V	Rated voltage (Use group D / UL 1059)	300 V
Rated current (Use group B / UL 1059)	10 A	Rated current (Use group D / UL 1059)	10 A
Wire cross-section, AWG, min.	AWG 28	Wire cross-section, AWG, max.	AWG 14
Reference to approval values	Specifications are maximum values, details - see approval certificate.		

Packing

Packaging	Box	VPE length	61 mm
VPE width	100 mm	VPE height	118 mm

Classifications

ETIM 6.0	EC002638	ETIM 7.0	EC002638
eClass 9.0	27-44-03-09	eClass 9.1	27-44-03-09
eClass 10.0	27-44-03-09	UNSPSC	30-21-18-10

Notes

Notes	<ul style="list-style-type: none"> • Additional colours on request • Gold-plated contact surfaces on request • Rated current related to rated cross-section & min. No. of poles. • Max. outer diameter of the conductor: 2.9 mm • Wire end ferrule without plastic collar to DIN 46228/1 • Wire end ferrule with plastic collar to DIN 46228/4 • P on drawing = pitch • Rated data refer only to the component itself. Clearance and creepage distances to other components are to be designed in accordance with the relevant application standards.
IPC conformity	Conformity: The products are developed, manufactured and delivered according international recognized standards and norms and comply with the assured properties in the data sheet resp. fulfill decorative properties in accordance with IPC-A-610 "Class 2". Further claims on the products can be evaluated on request.

Data sheet

**OMNIMATE Signal - series BL/SL 3.50
BL 3.50/24/180LH SN OR BX**

Weidmüller Interface GmbH & Co. KG
Klingenbergstraße 26
D-32758 Detmold
Germany
Fon: +49 5231 14-0
Fax: +49 5231 14-292083
www.weidmueller.com

Technical data

Approvals

Approvals



ROHS

Conform

Downloads

Approval/Certificate/Document of
Conformity

[Declaration of the Manufacturer](#)

Brochure/Catalogue

- [FL DRIVES EN](#)
- [MB DEVICE MANUF. EN](#)
- [FL DRIVES DE](#)
- [CAT 2 PORTFOLIOGUIDE EN](#)
- [FL BUILDING SAFETY EN](#)
- [FL APPL LED LIGHTING EN](#)
- [FLIndustr.CONTROLS EN](#)
- [FL MACHINE SAFETY EN](#)
- [FL HEATING ELECTR EN](#)
- [FL APPL INVERTER EN](#)
- [FL_BASE_STATION_EN](#)
- [FL ELEVATOR EN](#)
- [FL POWER SUPPLY EN](#)
- [FL 72H SAMPLE SER EN](#)
- [PO OMNIMATE EN](#)

Engineering Data

[EPLAN_WSCAD](#)

Engineering Data

[STEP](#)

Product Change Notification

[Change of Material LR 3.50 - DE](#)
[Change of Material LR 3.50 - EN](#)

**OMNIMATE Signal - series BL/SL 3.50
BL 3.50/24/180LH SN OR BX**

Weidmüller Interface GmbH & Co. KG
Klingenbergstraße 26
D-32758 Detmold
Germany
Fon: +49 5231 14-0
Fax: +49 5231 14-292083
www.weidmueller.com

Drawings

Dimensional drawing

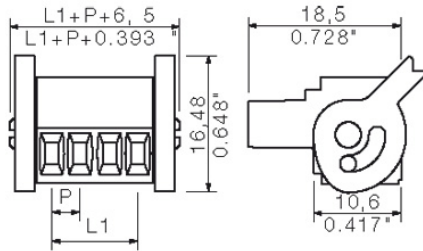

Graph

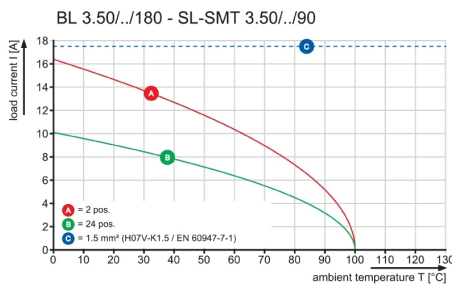

Graph

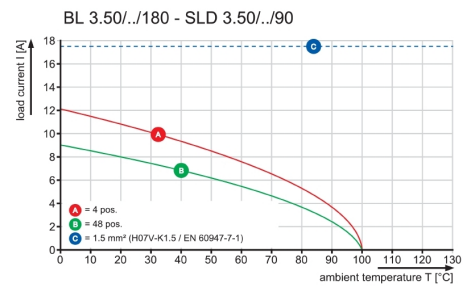

Graph

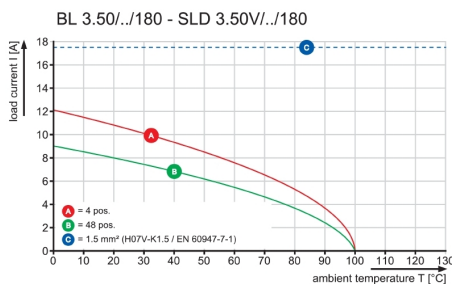

Graph

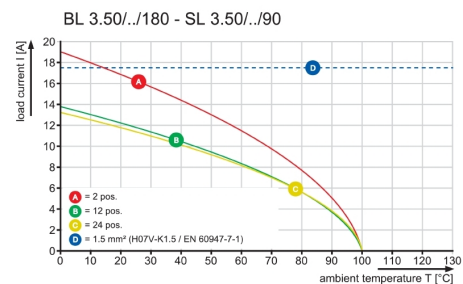

**OMNIMATE Signal - series BL/SL 3.50
BL 3.50/24/180LH SN OR BX**

Weidmüller Interface GmbH & Co. KG
Klingenbergstraße 26
D-32758 Detmold
Germany
Fon: +49 5231 14-0
Fax: +49 5231 14-292083
www.weidmueller.com

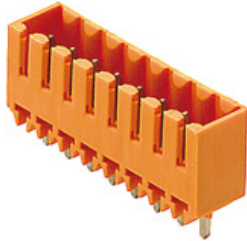
Mating connector (conditionally pluggable)
SL 3.50/180G

Pin headers for wave soldering in 3.50 mm pitch

- Plugging direction is parallel (90°), straight 180° or angled (135°) to the PCB
- Housing variant: screw flange (F)
- Packed in a cardboard box (BX)
- Pin header can be coded

General ordering data

Type	SL 3.50/24/180G 4.5SN B ...	Version	Product data	Packaging
Order No.	1618680000	PCB plug-in connector, male header, closed side, THT solder connection, 3.50 mm, Number of poles: 24, 180°, Solder pin length (l): 4.5 mm, tinned, black, Box	IEC: 320 V / 17 A UL: 300 V / 10 A	Box
GTIN (EAN)	4008190126384			
Qty.	20 pc(s).			
Type	SL 3.50/24/180G 3.2SN O ...	Version	Product data	Packaging
Order No.	1621860000	PCB plug-in connector, male header, closed side, THT solder connection, 3.50 mm, Number of poles: 24, 180°, Solder pin length (l): 3.2 mm, tinned, orange, Box	IEC: 320 V / 17 A UL: 300 V / 10 A	Box
GTIN (EAN)	4008190182076			
Qty.	20 pc(s).			

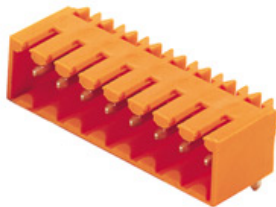
SL 3.50/90G

Pin headers for wave soldering in 3.50 mm pitch

- Plugging direction is parallel (90°), straight 180° or angled (135°) to the PCB
- Housing variant: screw flange (F)
- Packed in a cardboard box (BX)
- Pin header can be coded

General ordering data

Type	SL 3.50/24/90G 3.2SN OR ...	Version	Product data	Packaging
Order No.	1619450000	PCB plug-in connector, male header, closed side, THT solder connection, 3.50 mm, Number of poles: 24, 90°, Solder pin length (l): 3.2 mm, tinned, orange, Box	IEC: / 17 A UL: 300 V / 10 A	Box
GTIN (EAN)	4008190140137			
Qty.	20 pc(s).			
Type	SL 3.50/24/90G 4.5SN OR ...	Version	Product data	Packaging
Order No.	1617970000	PCB plug-in connector, male header, closed side, THT solder connection, 3.50 mm, Number of poles: 24, 90°, Solder pin length (l): 4.5 mm, tinned, orange, Box	IEC: / 17 A UL: 300 V / 10 A	Box
GTIN (EAN)	4008190114725			
Qty.	20 pc(s).			
Type	SL 3.50/24/90G 4.5SN BK ...	Version	Product data	Packaging
Order No.	1618050000	PCB plug-in connector, male header, closed side, THT solder connection, 3.50 mm, Number of poles: 24, 90°, Solder pin length (l): 4.5 mm, tinned, black, Box	IEC: / 17 A UL: 300 V / 10 A	Box
GTIN (EAN)	4008190116064			
Qty.	20 pc(s).			
Type	SL 3.50/24/90G 3.2SN DK ...	Version	Product data	Packaging
Order No.	1619760000	PCB plug-in connector, male header, closed side, THT solder connection, 3.50 mm, Number of poles: 24, 90°, Solder pin length (l): 3.2 mm, tinned, Signal green, Box	IEC: / 17 A UL: 300 V / 10 A	Box
GTIN (EAN)	4008190146665			
Qty.	20 pc(s).			

**OMNIMATE Signal - series BL/SL 3.50
BL 3.50/24/180LH SN OR BX**

Weidmüller Interface GmbH & Co. KG
Klingenbergstraße 26
D-32758 Detmold
Germany
Fon: +49 5231 14-0
Fax: +49 5231 14-292083
www.weidmueller.com

Mating connector (conditionally pluggable)

Type	SL 3.50/24/90G 3.2SN GY ...	Version	Product data	Packaging
Order No.	1619680000	PCB plug-in connector, male header, closed side, THT solder connection, 3.50 mm, Number of poles: 24, 90°, Solder pin length (l): 3.2 mm, tinned, Pebble grey, Box	IEC: / 17 A	Box
GTIN (EAN)	4008190144869		UL: 300 V / 10 A	
Qty.	20 pc(s).			

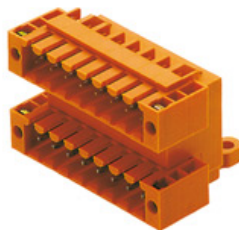
SLD 3.50/90F

Two-tier pin header for wave soldering in 3.50 mm pitch. The connector is available in open, closed and flange versions. The male connectors provide space for labelling and can be coded. Packed in a cardboard box.

General ordering data

Type	SLD 3.50/48/90F 3.2SN O ...	Version	Product data	Packaging
Order No.	1634030000	PCB plug-in connector, male header, Flange, THT solder connection, 3.50 mm, Number of poles: 48, 90°, Solder pin length (l): 3.2 mm, tinned, orange, Box	IEC: 200 V / 10.5 A	Box
GTIN (EAN)	4008190258481		UL: 300 V / 8 A	
Qty.	10 pc(s).			

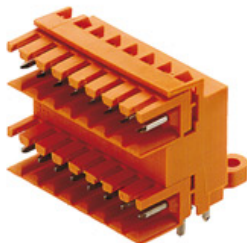
SLD 3.50/90

Two-tier pin header for wave soldering in 3.50 mm pitch. The connector is available in open, closed and flange versions. The male connectors provide space for labelling and can be coded. Packed in a cardboard box.

General ordering data

Type	SLD 3.50/48/90 3.2SN OR ...	Version	Product data	Packaging
Order No.	1633570000	PCB plug-in connector, male header, open side, THT solder connection, 3.50 mm, Number of poles: 48, 90°, Solder pin length (l): 3.2 mm, tinned, orange, Box	IEC: 200 V / 10.5 A	Box
GTIN (EAN)	4008190258023		UL: 300 V / 8 A	
Qty.	10 pc(s).			

**OMNIMATE Signal - series BL/SL 3.50
BL 3.50/24/180LH SN OR BX**

Weidmüller Interface GmbH & Co. KG
Klingenbergstraße 26
D-32758 Detmold
Germany
Fon: +49 5231 14-0
Fax: +49 5231 14-292083
www.weidmueller.com

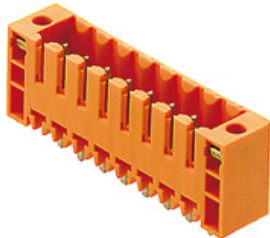
Mating connector (conditionally pluggable)
SL 3.50/180F

Pin headers for wave soldering in 3.50 mm pitch

- Plugging direction is parallel (90°), straight 180° or angled (135°) to the PCB
- Housing variant: screw flange (F)
- Packed in a cardboard box (BX)
- Pin header can be coded

General ordering data

Type	SL 3.50/24/180F 4.5SN O ...	Version	Product data	Packaging
Order No.	1618900000	PCB plug-in connector, male header, Flange, THT solder connection,	IEC: 320 V / 17 A	Box
GTIN (EAN)	4008190129590	3.50 mm, Number of poles: 24, 180°, Solder pin length (l): 4.5 mm,	UL: 300 V / 10 A	
Qty.	20 pc(s).	tinned, orange, Box		
Type	SL 3.50/24/180F 3.2SN G ...	Version	Product data	Packaging
Order No.	1622480000	PCB plug-in connector, male header, Flange, THT solder connection,	IEC: 320 V / 17 A	Box
GTIN (EAN)	4008190193140	3.50 mm, Number of poles: 24, 180°, Solder pin length (l): 3.2 mm,	UL: 300 V / 10 A	
Qty.	20 pc(s).	tinned, Pebble grey, Box		
Type	SL 3.50/24/180F 3.2SN D ...	Version	Product data	Packaging
Order No.	1622700000	PCB plug-in connector, male header, Flange, THT solder connection,	IEC: 320 V / 17 A	Box
GTIN (EAN)	4008190193362	3.50 mm, Number of poles: 24, 180°, Solder pin length (l): 3.2 mm,	UL: 300 V / 10 A	
Qty.	20 pc(s).	tinned, Signal green, Box		
Type	SL 3.50/24/180F 4.5 SN ...	Version	Product data	Packaging
Order No.	1618980000	PCB plug-in connector, male header, Flange, THT solder connection,	IEC: 320 V / 17 A	Box
GTIN (EAN)	4008190131418	3.50 mm, Number of poles: 24, 180°, Solder pin length (l): 4.5 mm,	UL: 300 V / 10 A	
Qty.	20 pc(s).	tinned, black, Box		
Type	SL 3.50/24/180F 3.2SN O ...	Version	Product data	Packaging
Order No.	1622250000	PCB plug-in connector, male header, Flange, THT solder connection,	IEC: 320 V / 17 A	Box
GTIN (EAN)	4008190189723	3.50 mm, Number of poles: 24, 180°, Solder pin length (l): 3.2 mm,	UL: 300 V / 10 A	
Qty.	20 pc(s).	tinned, orange, Box		

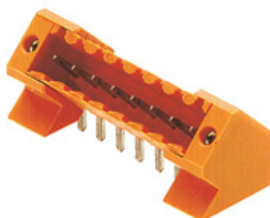
SL 3.50/135F

Pin headers for wave soldering in 3.50 mm pitch

- Plugging direction is parallel (90°), straight 180° or angled (135°) to the PCB
- Housing variant: screw flange (F)
- Packed in a cardboard box (BX)
- Pin header can be coded

General ordering data

Type	SL 3.50/24/135F 3.2SN O ...	Version	Product data	Packaging
Order No.	1643550000	PCB plug-in connector, male header, Flange, THT solder connection,	IEC: 320 V / 15 A	Box
GTIN (EAN)	4008190282318	3.50 mm, Number of poles: 24, 135°, Solder pin length (l): 3.2 mm,	UL: 300 V / 10 A	
Qty.	18 pc(s).	tinned, orange, Box		

**OMNIMATE Signal - series BL/SL 3.50
BL 3.50/24/180LH SN OR BX**

Weidmüller Interface GmbH & Co. KG
Klingenbergstraße 26
D-32758 Detmold
Germany
Fon: +49 5231 14-0
Fax: +49 5231 14-292083
www.weidmueller.com

Mating connector (conditionally pluggable)
SL-SMT 3.5/90G Tray

High-temperature-resistant male header, 3.50 mm pitch.

- **Plugging direction parallel (90°), straight 180° or angled (135°) to PCB**
- **Housing variants: closed side (G), screw flange (F), solder flange (LF) or snap-on solder flange (RF)**
- **Optimised for the SMT process**
- **Pin length 3.2 mm universal for all soldering methods**
- **Pin length 1.5 mm optimised for reflow soldering methods**
- **Packed either in a box (BX) or tape-on-reel (RL)**
- **Male header can be coded**

General ordering data

Type	SL-SMT 3.50/24/90G 1.5S ...	Version	Product data	Packaging
Order No.	1761763001	PCB plug-in connector, male header, closed side, THT/THR solder connection, 3.50 mm, Number of poles: 24, 90°, Solder pin length (l): 1.5 mm, tinned, black, Tray	IEC: 320 V / 15 A	Tray
GTIN (EAN)	4032248134038		UL: 300 V / 10 A	
Qty.	18 pc(s).			

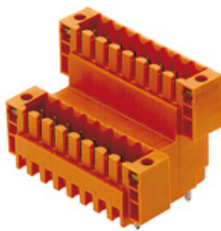
SLD 3.50V/180F

Double-level, staggered pin header for wave soldering at 3.50 mm pitch. They are available in closed and flanged versions. The male connectors provide space for labelling and can be coded.

General ordering data

Type	SLD 3.50 V/48/180F 3.2 ...	Version	Product data	Packaging
Order No.	1641350000	PCB plug-in connector, male header, Flange, THT solder connection, 3.50 mm, Number of poles: 48, 180°, Solder pin length (l): 3.2 mm, tinned, orange, Box	IEC: 200 V / 10.5 A	Box
GTIN (EAN)	4008190279752		UL: 300 V / 8 A	
Qty.	10 pc(s).			

**OMNIMATE Signal - series BL/SL 3.50
BL 3.50/24/180LH SN OR BX**

Weidmüller Interface GmbH & Co. KG
Klingenbergstraße 26
D-32758 Detmold
Germany
Fon: +49 5231 14-0
Fax: +49 5231 14-292083
www.weidmueller.com

Mating connector (conditionally pluggable)
SL-THR 3.5/135F

High-temperature-resistant male header, 3.50 mm pitch.

- **Plugging direction parallel (90°), straight 180° or angled (135°) to PCB**
- **Housing variants: closed side (G), screw flange (F), solder flange (LF) or snap-on solder flange (RF)**
- **Optimised for the SMT process**
- **Pin length 3.2 mm universal for all soldering methods**
- **Pin length 1.5 mm optimised for reflow soldering methods**
- **Packed either in a box (BX) or tape-on-reel (RL)**
- **Male header can be coded**

General ordering data

Type	SL-SMT 3.50/24/135F 3.2 ...	Version	Product data	Packaging
Order No.	1003740000	PCB plug-in connector, male header, Flange, THT/THR solder connection, 3.50 mm, Number of poles: 24, 135°, Solder pin length (l): 3.2 mm, tinned, black, Box	IEC: 320 V / 15 A UL: 300 V / 10 A	Box
GTIN (EAN)	4032248700363			
Qty.	18 pc(s).			

SLD 3.50V/90G



Double-level, staggered pin header for wave soldering at 3.50 mm pitch. They are available in closed and flanged versions. The male connectors provide space for labelling and can be coded.

General ordering data

Type	SLD 3.50V/48/90G 3.2SN ...	Version	Product data	Packaging
Order No.	1642350000	PCB plug-in connector, male header, closed side, THT solder connection, 3.50 mm, Number of poles: 48, 90°, Solder pin length (l): 3.2 mm, tinned, orange, Box	IEC: 200 V / 10.5 A UL: 300 V / 8 A	Box
GTIN (EAN)	4008190280871			
Qty.	10 pc(s).			

**OMNIMATE Signal - series BL/SL 3.50
BL 3.50/24/180LH SN OR BX**

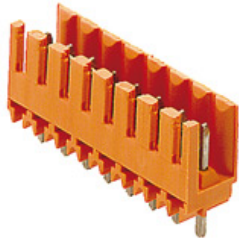
Weidmüller Interface GmbH & Co. KG
Klingenbergstraße 26
D-32758 Detmold
Germany
Fon: +49 5231 14-0
Fax: +49 5231 14-292083
www.weidmueller.com

Mating connector (conditionally pluggable)
SL 3.50/180

Pin headers for wave soldering in 3.50 mm pitch

- Plugging direction is parallel (90°), straight 180° or angled (135°) to the PCB
- Housing variant: screw flange (F)
- Packed in a cardboard box (BX)
- Pin header can be coded

General ordering data

Type	SL 3.50/24/180 3.2SN OR ...	Version	Product data	Packaging
Order No.	1621470000	PCB plug-in connector, male header, open side, THT solder connection, 3.50 mm, Number of poles: 24, 180°, Solder pin length (l): 3.2 mm, tinned, orange, Box	IEC: 320 V / 17 A UL: 300 V / 10 A	Box
GTIN (EAN)	4008190173890			
Qty.	20 pc(s).			

SL-SMT 3.5/180G Box

High-temperature-resistant male header, 3.50 mm pitch.

- **Plugging direction parallel (90°), straight 180° or angled (135°) to PCB**
- **Housing variants: closed side (G), screw flange (F), solder flange (LF) or snap-on solder flange (RF)**
- **Optimised for the SMT process**
- **Pin length 3.2 mm universal for all soldering methods**
- **Pin length 1.5 mm optimised for reflow soldering methods**
- **Packed either in a box (BX) or tape-on-reel (RL)**
- **Male header can be coded**

General ordering data

Type	SL-SMT 3.50/24/180G 3.2 ...	Version	Product data	Packaging
Order No.	1842530000	PCB plug-in connector, male header, closed side, THT/THR solder connection, 3.50 mm, Number of poles: 24, 180°, Solder pin length (l): 3.2 mm, tinned, black, Box	IEC: 320 V / 15 A UL: 300 V / 10 A	Box
GTIN (EAN)	4032248353897			
Qty.	20 pc(s).			
Type	SL-SMT 3.50/24/180G 1.5 ...	Version	Product data	Packaging
Order No.	1753202001	PCB plug-in connector, male header, closed side, THT/THR solder connection, 3.50 mm, Number of poles: 24, 180°, Solder pin length (l): 1.5 mm, tinned, black, Box	IEC: 320 V / 15 A UL: 300 V / 10 A	Box
GTIN (EAN)	4032248131105			
Qty.	20 pc(s).			

**OMNIMATE Signal - series BL/SL 3.50
BL 3.50/24/180LH SN OR BX**

Weidmüller Interface GmbH & Co. KG
 Klingenbergstraße 26
 D-32758 Detmold
 Germany
 Fon: +49 5231 14-0
 Fax: +49 5231 14-292083
 www.weidmueller.com

Mating connector (conditionally pluggable)
SL-SMT 3.5/180G Tray

High-temperature-resistant male header, 3.50 mm pitch.

- **Plugging direction parallel (90°), straight 180° or angled (135°) to PCB**
- **Housing variants: closed side (G), screw flange (F), solder flange (LF) or snap-on solder flange (RF)**
- **Optimised for the SMT process**
- **Pin length 3.2 mm universal for all soldering methods**
- **Pin length 1.5 mm optimised for reflow soldering methods**
- **Packed either in a box (BX) or tape-on-reel (RL)**
- **Male header can be coded**

General ordering data

Type	SL-SMT 3.50/24/180G 1.5 ...	Version	Product data	Packaging
Order No.	1753203001	PCB plug-in connector, male header, closed side, THT/THR solder connection, 3.50 mm, Number of poles: 24, 180°, Solder pin length (!): 1.5 mm, tinned, black, Tray	IEC: 320 V / 15 A UL: 300 V / 10 A	Tray
GTIN (EAN)	4032248133079			
Qty.	18 pc(s).			

SL-SMT 3.5/90G Box

High-temperature-resistant male header, 3.50 mm pitch.

- **Plugging direction parallel (90°), straight 180° or angled (135°) to PCB**
- **Housing variants: closed side (G), screw flange (F), solder flange (LF) or snap-on solder flange (RF)**
- **Optimised for the SMT process**
- **Pin length 3.2 mm universal for all soldering methods**
- **Pin length 1.5 mm optimised for reflow soldering methods**
- **Packed either in a box (BX) or tape-on-reel (RL)**
- **Male header can be coded**

General ordering data

Type	SL-SMT 3.50/24/90G 3.2S ...	Version	Product data	Packaging
Order No.	1841850000	PCB plug-in connector, male header, closed side, THT/THR solder connection, 3.50 mm, Number of poles: 24, 90°, Solder pin length (!): 3.2 mm, tinned, black, Box	IEC: 320 V / 15 A UL: 300 V / 10 A	Box
GTIN (EAN)	4032248353200			
Qty.	20 pc(s).			

**OMNIMATE Signal - series BL/SL 3.50
BL 3.50/24/180LH SN OR BX**

Weidmüller Interface GmbH & Co. KG
Klingenbergstraße 26
D-32758 Detmold
Germany
Fon: +49 5231 14-0
Fax: +49 5231 14-292083
www.weidmueller.com

Mating connector (conditionally pluggable)

Type	SL-SMT 3.50/24/90G 1.5S ...	Version	Product data	Packaging
Order No.	1761762001	PCB plug-in connector, male header, closed side, THT/THR solder connection, 3.50 mm, Number of poles: 24, 90°, Solder pin length (l): 1.5 mm, tinned, black, Box	IEC: 320 V / 15 A UL: 300 V / 10 A	Box
GTIN (EAN)	4032248132355			
Qty.	20 pc(s).			

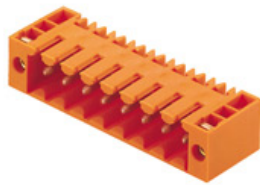
SL 3.50/90F

Pin headers for wave soldering in 3.50 mm pitch

- Plugging direction is parallel (90°), straight 180° or angled (135°) to the PCB
- Housing variant: screw flange (F)
- Packed in a cardboard box (BX)
- Pin header can be coded

General ordering data

Type	SL 3.50/24/90F 3.2SN OR ...	Version	Product data	Packaging
Order No.	1619840000	PCB plug-in connector, male header, Flange, THT solder connection, 3.50 mm, Number of poles: 24, 90°, Solder pin length (l): 3.2 mm, tinned, orange, Box	IEC: / 17 A UL: 300 V / 10 A	Box
GTIN (EAN)	4008190147679			
Qty.	20 pc(s).			
Type	SL 3.50/24/90F 3.2SN GY ...	Version	Product data	Packaging
Order No.	1620070000	PCB plug-in connector, male header, Flange, THT solder connection, 3.50 mm, Number of poles: 24, 90°, Solder pin length (l): 3.2 mm, tinned, Pebble grey, Box	IEC: / 17 A UL: 300 V / 10 A	Box
GTIN (EAN)	4008190151263			
Qty.	20 pc(s).			
Type	SL 3.50/24/90F 3.2SN DK ...	Version	Product data	Packaging
Order No.	1620280000	PCB plug-in connector, male header, Flange, THT solder connection, 3.50 mm, Number of poles: 24, 90°, Solder pin length (l): 3.2 mm, tinned, Signal green, Box	IEC: / 17 A UL: 300 V / 10 A	Box
GTIN (EAN)	4008190154004			
Qty.	20 pc(s).			
Type	SL 3.50/24/90F 4.5SN OR ...	Version	Product data	Packaging
Order No.	1618270000	PCB plug-in connector, male header, Flange, THT solder connection, 3.50 mm, Number of poles: 24, 90°, Solder pin length (l): 4.5 mm, tinned, orange, Box	IEC: / 17 A UL: 300 V / 10 A	Box
GTIN (EAN)	4008190119652			
Qty.	20 pc(s).			
Type	SL 3.50/24/90F 4.5 SN B ...	Version	Product data	Packaging
Order No.	1618350000	PCB plug-in connector, male header, Flange, THT solder connection, 3.50 mm, Number of poles: 24, 90°, Solder pin length (l): 4.5 mm, tinned, black, Box	IEC: / 17 A UL: 300 V / 10 A	Box
GTIN (EAN)	4008190121075			
Qty.	20 pc(s).			

**OMNIMATE Signal - series BL/SL 3.50
BL 3.50/24/180LH SN OR BX**

Weidmüller Interface GmbH & Co. KG
Klingenbergstraße 26
D-32758 Detmold
Germany
Fon: +49 5231 14-0
Fax: +49 5231 14-292083
www.weidmueller.com

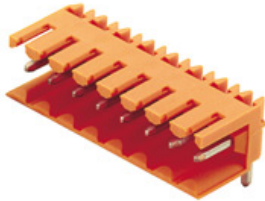
Mating connector (conditionally pluggable)
SL 3.50/90

Pin headers for wave soldering in 3.50 mm pitch

- Plugging direction is parallel (90°), straight 180° or angled (135°) to the PCB
- Housing variant: screw flange (F)
- Packed in a cardboard box (BX)
- Pin header can be coded

General ordering data

Type	SL 3.50/24/90 3.2SN DKG ...	Version	Product data	Packaging
Order No.	1619370000	PCB plug-in connector, male header, open side, THT solder	IEC: 320 V / 17 A	Box
GTIN (EAN)	4008190138578	connection, 3.50 mm, Number of poles: 24, 90°, Solder pin length (l):	UL: 300 V / 10 A	
Qty.	20 pc(s).	3.2 mm, tinned, Signal green, Box		
Type	SL 3.50/24/90 3.2SN OR ...	Version	Product data	Packaging
Order No.	1619060000	PCB plug-in connector, male header, open side, THT solder	IEC: 320 V / 17 A	Box
GTIN (EAN)	4008190133047	connection, 3.50 mm, Number of poles: 24, 90°, Solder pin length (l):	UL: 300 V / 10 A	
Qty.	20 pc(s).	3.2 mm, tinned, orange, Box		
Type	SL 3.50/24/90G 4.5SN BK ...	Version	Product data	Packaging
Order No.	1617890000	PCB plug-in connector, male header, open side, THT solder	IEC: 320 V / 17 A	Box
GTIN (EAN)	4008190113780	connection, 3.50 mm, Number of poles: 24, 90°, Solder pin length (l):	UL: 300 V / 10 A	
Qty.	20 pc(s).	4.5 mm, tinned, black, Box		
Type	SL 3.50/24/90 3.2SN GY ...	Version	Product data	Packaging
Order No.	1619290000	PCB plug-in connector, male header, open side, THT solder	IEC: 320 V / 17 A	Box
GTIN (EAN)	4008190137502	connection, 3.50 mm, Number of poles: 24, 90°, Solder pin length (l):	UL: 300 V / 10 A	
Qty.	20 pc(s).	3.2 mm, tinned, Pebble grey, Box		
Type	SL 3.50/24/90 4.5SN OR ...	Version	Product data	Packaging
Order No.	1617810000	PCB plug-in connector, male header, open side, THT solder	IEC: 320 V / 17 A	Box
GTIN (EAN)	4008190112554	connection, 3.50 mm, Number of poles: 24, 90°, Solder pin length (l):	UL: 300 V / 10 A	
Qty.	20 pc(s).	4.5 mm, tinned, orange, Box		

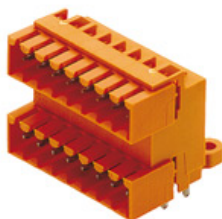
SLD 3.50/90G

Two-tier pin header for wave soldering in 3.50 mm pitch. The connector is available in open, closed and flange versions. The male connectors provide space for labelling and can be coded. Packed in a cardboard box.

General ordering data

Type	SLD 3.50/48/90G 3.2SN O ...	Version	Product data	Packaging
Order No.	1633800000	PCB plug-in connector, male header, closed side, THT solder	IEC: 200 V / 10.5 A	Box
GTIN (EAN)	4008190258252	connection, 3.50 mm, Number of poles: 48, 90°, Solder pin length (l):	UL: 300 V / 8 A	
Qty.	10 pc(s).	3.2 mm, tinned, orange, Box		

**OMNIMATE Signal - series BL/SL 3.50
BL 3.50/24/180LH SN OR BX**

Weidmüller Interface GmbH & Co. KG
 Klingenbergstraße 26
 D-32758 Detmold
 Germany
 Fon: +49 5231 14-0
 Fax: +49 5231 14-292083
 www.weidmueller.com

Mating connector (conditionally pluggable)

Type	SLD 3.50/48/90G 3.2SN D ...	Version	Product data	Packaging
Order No.	1675070000	PCB plug-in connector, male header, closed side, THT solder	IEC: 200 V / 10.5 A	Box
GTIN (EAN)	4008190445768	connection, 3.50 mm, Number of poles: 48, 90°, Solder pin length (l):	UL: 300 V / 8 A	
Qty.	10 pc(s).	3.2 mm, tinned, Signal green, Box		

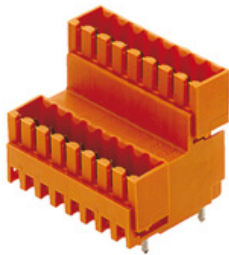
SLD 3.50V/180G

Double-level, staggered pin header for wave soldering at 3.50 mm pitch. They are available in closed and flanged versions. The male connectors provide space for labelling and can be coded.

General ordering data

Type	SLD 3.50V/48/180G 3.2SN ...	Version	Product data	Packaging
Order No.	1641220000	PCB plug-in connector, male header, closed side, THT solder	IEC: 200 V / 10.5 A	Box
GTIN (EAN)	4008190279622	connection, 3.50 mm, Number of poles: 48, 180°, Solder pin length	UL: 300 V / 8 A	
Qty.	10 pc(s).	(l): 3.2 mm, tinned, orange, Box		

**OMNIMATE Signal - series BL/SL 3.50
BL 3.50/24/180LH SN OR BX**

Weidmüller Interface GmbH & Co. KG
Klingenbergstraße 26
D-32758 Detmold
Germany
Fon: +49 5231 14-0
Fax: +49 5231 14-292083
www.weidmueller.com

Mating connector (fully pluggable)
SL-SMT 3.5/90LF Box

High-temperature-resistant male header, 3.50 mm pitch.

- **Plugging direction parallel (90°), straight 180° or angled (135°) to PCB**
- **Housing variants: closed side (G), screw flange (F), solder flange (LF) or snap-on solder flange (RF)**
- **Optimised for the SMT process**
- **Pin length 3.2 mm universal for all soldering methods**
- **Pin length 1.5 mm optimised for reflow soldering methods**
- **Packed either in a box (BX) or tape-on-reel (RL)**
- **Male header can be coded**

General ordering data

Type	SL-SMT 3.50/24/90LF 1.5 ...	Version	Product data	Packaging
Order No.	1805160000	PCB plug-in connector, male header, Solder flange, THT/THR solder connection, 3.50 mm, Number of poles: 24, 90°, Solder pin length (l): 1.5 mm, tinned, black, Box	IEC: 320 V / 15 A UL: 300 V / 10 A	Box
GTIN (EAN)	4032248269068			
Qty.	18 pc(s).			
Type	SL-SMT 3.50/24/90LF 3.2 ...	Version	Product data	Packaging
Order No.	1842070000	PCB plug-in connector, male header, Solder flange, THT/THR solder connection, 3.50 mm, Number of poles: 24, 90°, Solder pin length (l): 3.2 mm, tinned, black, Box	IEC: 320 V / 15 A UL: 300 V / 10 A	Box
GTIN (EAN)	4032248353422			
Qty.	18 pc(s).			

**OMNIMATE Signal - series BL/SL 3.50
BL 3.50/24/180LH SN OR BX**

Weidmüller Interface GmbH & Co. KG
Klingenbergstraße 26
D-32758 Detmold
Germany
Fon: +49 5231 14-0
Fax: +49 5231 14-292083
www.weidmuller.com

Mating connector (fully pluggable)
SL-SMT 3.5/180F Box

High-temperature-resistant male header, 3.50 mm pitch.

- **Plugging direction parallel (90°), straight 180° or angled (135°) to PCB**
- **Housing variants: closed side (G), screw flange (F), solder flange (LF) or snap-on solder flange (RF)**
- **Optimised for the SMT process**
- **Pin length 3.2 mm universal for all soldering methods**
- **Pin length 1.5 mm optimised for reflow soldering methods**
- **Packed either in a box (BX) or tape-on-reel (RL)**
- **Male header can be coded**

General ordering data

Type	SL-SMT 3.50/24/180F 3.2 ...	Version	Product data	Packaging
Order No.	1842990000	PCB plug-in connector, male header, Flange, THT/THR solder connection, 3.50 mm, Number of poles: 24, 180°, Solder pin length (l): 3.2 mm, tinned, black, Box	IEC: 320 V / 15 A UL: 300 V / 10 A	Box
GTIN (EAN)	4032248354450			
Qty.	18 pc(s).			

SLD 3.50V/90F

Double-level, staggered pin header for wave soldering at 3.50 mm pitch. They are available in closed and flanged versions. The male connectors provide space for labelling and can be coded.

General ordering data

Type	SLD 3.50 V/48/90F 3.2 S ...	Version	Product data	Packaging
Order No.	1642480000	PCB plug-in connector, male header, Flange, THT solder connection, 3.50 mm, Number of poles: 48, 90°, Solder pin length (l): 3.2 mm, tinned, orange, Box	IEC: 200 V / 10.5 A UL: 300 V / 8 A	Box
GTIN (EAN)	4008190281007			
Qty.	10 pc(s).			

**OMNIMATE Signal - series BL/SL 3.50
BL 3.50/24/180LH SN OR BX**

Weidmüller Interface GmbH & Co. KG
Klingenbergstraße 26
D-32758 Detmold
Germany
Fon: +49 5231 14-0
Fax: +49 5231 14-292083
www.weidmueller.com

Mating connector (fully pluggable)
SL-SMT 3.5/90F Box

High-temperature-resistant male header, 3.50 mm pitch.

- **Plugging direction parallel (90°), straight 180° or angled (135°) to PCB**
- **Housing variants: closed side (G), screw flange (F), solder flange (LF) or snap-on solder flange (RF)**
- **Optimised for the SMT process**
- **Pin length 3.2 mm universal for all soldering methods**
- **Pin length 1.5 mm optimised for reflow soldering methods**
- **Packed either in a box (BX) or tape-on-reel (RL)**
- **Male header can be coded**

General ordering data

Type	SL-SMT 3.50/24/90F 3.2S ...	Version	Product data	Packaging
Order No.	1842300000	PCB plug-in connector, male header, Flange, THT/THR solder connection, 3.50 mm, Number of poles: 24, 90°, Solder pin length (l): 3.2 mm, tinned, black, Box	IEC: 320 V / 15 A	Box
GTIN (EAN)	4032248353651		UL: 300 V / 10 A	
Qty.	18 pc(s).			

SL-SMT 3.5/180LF Box

High-temperature-resistant male header, 3.50 mm pitch.

- **Plugging direction parallel (90°), straight 180° or angled (135°) to PCB**
- **Housing variants: closed side (G), screw flange (F), solder flange (LF) or snap-on solder flange (RF)**
- **Optimised for the SMT process**
- **Pin length 3.2 mm universal for all soldering methods**
- **Pin length 1.5 mm optimised for reflow soldering methods**
- **Packed either in a box (BX) or tape-on-reel (RL)**
- **Male header can be coded**

General ordering data

Type	SL-SMT 3.50/24/180LF 3. ...	Version	Product data	Packaging
Order No.	1842760000	PCB plug-in connector, male header, Solder flange, THT/THR solder connection, 3.50 mm, Number of poles: 24, 180°, Solder pin length (l): 3.2 mm, tinned, black, Box	IEC: 320 V / 15 A	Box
GTIN (EAN)	4032248354122		UL: 300 V / 10 A	
Qty.	18 pc(s).			

Data sheet

**OMNIMATE Signal - series BL/SL 3.50
BL 3.50/24/180LH SN OR BX**

Weidmüller Interface GmbH & Co. KG
 Klingenbergstraße 26
 D-32758 Detmold
 Germany
 Fon: +49 5231 14-0
 Fax: +49 5231 14-292083
 www.weidmueller.com

Mating connector (fully pluggable)

Type	SL-SMT 3.50/24/180LF 1. ...	Version	Product data	Packaging
Order No.	1804930000	PCB plug-in connector, male header, Solder flange, THT/THR solder	IEC: 320 V / 15 A	Box
GTIN (EAN)	4032248268696	connection, 3.50 mm, Number of poles: 24, 180°, Solder pin length	UL: 300 V / 10 A	
Qty.	18 pc(s).	(I): 1.5 mm, tinned, black, Box		

OMNIMATE Signal - series BL/SL 3.50 BL 3.50/24/180LH SN OR BX

Weidmüller Interface GmbH & Co. KG
 Klingenbergstraße 26
 D-32758 Detmold
 Germany
 Fon: +49 5231 14-0
 Fax: +49 5231 14-292083
 www.weidmueller.com

Accessories

Strain reliefs



For frequent load changes: the "trailer coupling" for plug-in connectors.

The strain relief can do more than just relieve the strain on conductors:

Simply clip onto the plug and

- bundle conductors
- guide cables
- use as a connection and disconnection aid

No damage to the connecting points, clear, tidy wiring and easy to handle.

User advantages: permanent heavy-duty connections for harsh industrial environments and convenient operation ensure improved system availability.

General ordering data

Type	BL 3.50 ZE08 BK BX	Version	Product data	Packaging
Order No.	1627830000	PCB plug-in connector, Accessories, Strain relief, black, Number of		Box
GTIN (EAN)	4008190202576	poles: 8		
Qty.	50 pc(s).			
Type	BL 3.50 ZE03 BK BX	Version	Product data	Packaging
Order No.	1627820000	PCB plug-in connector, Accessories, Strain relief, black, Number of		Box
GTIN (EAN)	4008190202552	poles: 3		
Qty.	50 pc(s).			
Type	BL 3.50 ZE03 OR BX	Version	Product data	Packaging
Order No.	1629680000	PCB plug-in connector, Accessories, Strain relief, orange, Number of		Box
GTIN (EAN)	4008190202569	poles: 3		
Qty.	50 pc(s).			
Type	BL 3.50 ZE08 OR BX	Version	Product data	Packaging
Order No.	1629690000	PCB plug-in connector, Accessories, Strain relief, orange, Number of		Box
GTIN (EAN)	4008190202583	poles: 8		
Qty.	50 pc(s).			

OMNIMATE Signal - series BL/SL 3.50 BL 3.50/24/180LH SN OR BX

Weidmüller Interface GmbH & Co. KG
 Klingenbergstraße 26
 D-32758 Detmold
 Germany
 Fon: +49 5231 14-0
 Fax: +49 5231 14-292083
 www.weidmueller.com

Accessories

Coding elements



**Only connects what is supposed to be connected:
the right connection at the right place.**

Coding elements and locking devices clearly assign connecting elements during the manufacturing process and operation

The coding elements and locking devices are inserted prior to assembly or during the cable assembly phase. The Weidmüller alternative: configure online using the variant configurator to precode prior to delivery.

Incorrect assembly on the circuit board and incorrect plugging of connecting elements is no longer possible. The advantage: no troubleshooting during manufacture and no operational errors by the user.

General ordering data

Type	BL SL 3.5 KO SW	Version	Product data	Packaging
Order No.	1610100000	PCB plug-in connector, Accessories, Coding element, black, Number		Box
GTIN (EAN)	4008190187637	of poles: 1		
Qty.	100 pc(s).			
Type	BL SL 3.5 KO OR	Version	Product data	Packaging
Order No.	1693430000	PCB plug-in connector, Accessories, Coding element, orange, Number		Box
GTIN (EAN)	4008190867447	of poles: 1		
Qty.	100 pc(s).			

DIE DEUTSCHE VERSION IST VERBINDLICH
THE GERMAN VERSION IS BINDING

WEITERGABE SOWIE VERVIELFÄLTIGUNG DIESES DOKUMENTS, VERWERTUNG UND MITTEILUNG SEINES INHALTS SIND VERBOTEN, SOWEIT NICHT AUSDRUECKLICH GESTATTET.
ZUWIDERHANDLUNGEN VERPFLICHTEN ZU SCHADENERSATZ. ALLE RECHTE FUER DEN FALL DER PATENT-, GEBRAUCHSMUSTER- ODER GESCHMACKSMUSTERENTRAGUNG VORBEHALTEN.
THE REPRODUCTION, DISTRIBUTION AND UTILIZATION OF THIS DOCUMENT AS WELL AS THE COMMUNICATION OF ITS CONTENTS TO OTHERS WITHOUT EXPLICIT AUTHORIZATION IS PROHIBITED.
OFFENDERS WILL BE HELD LIABLE FOR THE PAYMENT OF DAMAGES. WEIDMUELLER EXCLUSIVELY RESERVES THE RIGHT TO FILE FOR PATENTS, UTILITY MODELS OR DESIGNS.
© WEIDMUELLER INTERFACE GmbH & Co.KG

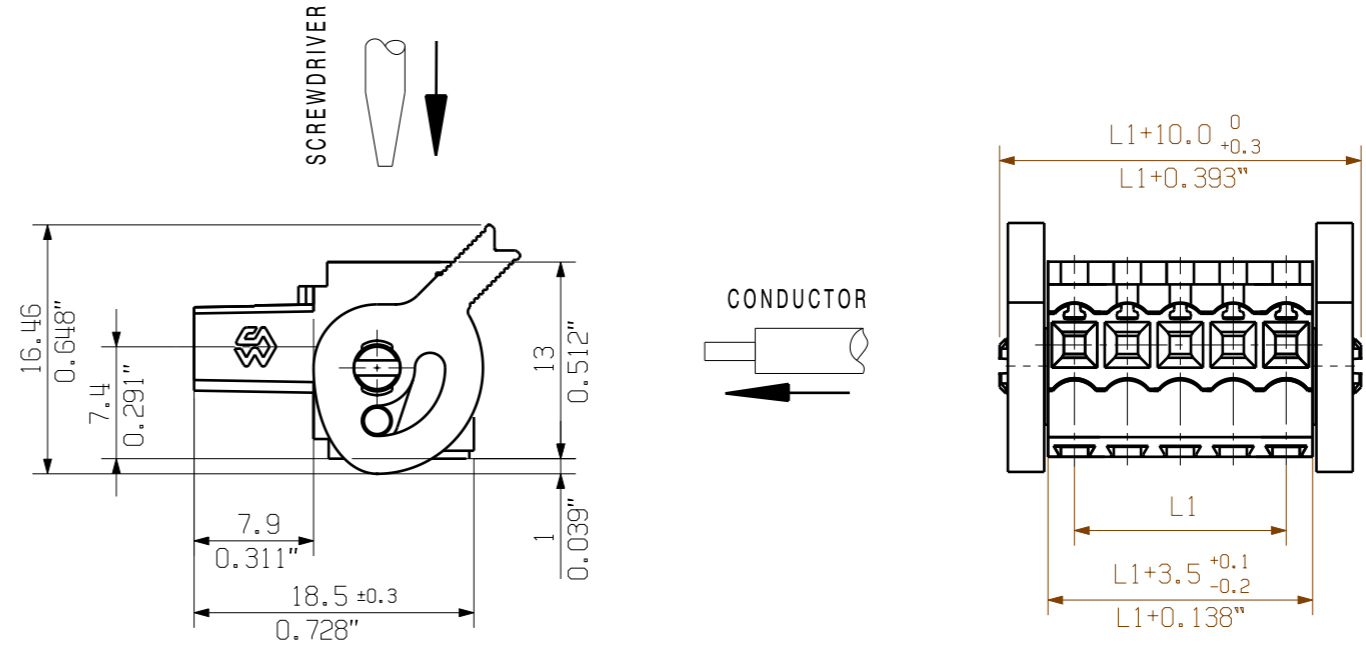

24	80,50	3,169
23	77,00	3,031
22	73,50	2,894
21	70,00	2,756
20	66,50	2,618
19	63,00	2,480
18	59,50	2,343
17	56,00	2,205
16	52,50	2,067
15	49,00	1,929
14	45,50	1,791
13	42,00	1,654
12	38,50	1,516
11	35,00	1,378
10	31,50	1,240
9	28,00	1,102
8	24,50	0,965
7	21,00	0,827
6	17,50	0,689
5	14,00	0,551
4	10,50	0,413
3	7,00	0,276
2	3,50	0,138
n	L1 [mm]	L1 [inch]

For the mounting of PCBs, it should be noted that the rated data given in the catalogue relates only to the connection elements. The necessary creepage and clearance paths must be observed in connection with the respective applicant in accordance to VDE 0110. The current-carrying capacity and pitch tolerance is to be determined according to DIN IEC 326 part 3 very fine.

Weidmüller PCB components are tested to the DIN VDE 0627 standard, and are valid for its field of application. Provided that the components are used to the intended purpose, all requirements with respect to the occurring of electrical, mechanical, thermic and corrosive stress will be satisfied.

SHOWN: BL 3.50/04/180/LH...

	DIN ISO 2768-m	69114/0 20.03.13 HELIS_MA 01		CAT.NO.:	
		MODIFICATION		C 22682 11	
	DRAWN 21.07.2009 HELIS_MA RESPONSIBLE LANG_T CHECKED 04.04.2013 HECKERT_M APPROVED HECKERT_M	DATE NAME	BL 3.50/./180/ L(H/R) BUCHSENLEISTE SOCKET BLOCK		
SCALE: 2/1 SUPERSEDES:	PRODUCT FILE: BL 3.50		SHEET 01 OF 02 SHEETS 7382		