

OMNIMATE Signal - series BL/SL 3.50 BL 3.50/07/180LH SN OR BX

Weidmüller Interface GmbH & Co. KG
Klingenbergstraße 26
D-32758 Detmold
Germany
Fon: +49 5231 14-0
Fax: +49 5231 14-292083
www.weidmueller.com

Product image

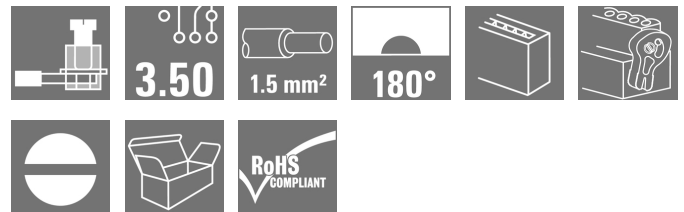

Similar to illustration

Female connectors with clamping yoke screw system for connecting conductors at 3.50 mm pitch. They provide space for labelling and can be coded.

General ordering data

Type	BL 3.50/07/180LH SN OR BX
Order No.	1687700000
Version	PCB plug-in connector, female plug, 3.50 mm, Number of poles: 7, 180°, Clamping yoke connection, Clamping range, max. : 1.5 mm², Box
GTIN (EAN)	4008190853259
Qty.	54 pc(s).
Product data	IEC: 320 V / 17 A / 0.2 - 1.5 mm² UL: 300 V / 10 A / AWG 28 - AWG 14
Packaging	Box

Creation date May 3, 2020 2:15:27 PM CEST

**OMNIMATE Signal - series BL/SL 3.50
BL 3.50/07/180LH SN OR BX**

Weidmüller Interface GmbH & Co. KG
 Klingenbergstraße 26
 D-32758 Detmold
 Germany
 Fon: +49 5231 14-0
 Fax: +49 5231 14-292083
 www.weidmueller.com

Technical data**Dimensions and weights**

Width	31 mm	Width (inches)	1.22 inch
Height	14.9 mm	Height (inches)	0.587 inch
Depth	29.5 mm	Depth (inches)	1.161 inch
Net weight	6.907 g		

System Parameters

Product family	OMNIMATE Signal - series BL/SL 3.50	Type of connection	Field connection
Wire connection method	Clamping yoke connection	Pitch in mm (P)	3.5 mm
Pitch in inches (P)	0.138 inch	Conductor outlet direction	180°
Number of poles	7	L1 in mm	21 mm
L1 in inches	0.827 inch	Number of rows	1
Pin series quantity	1	Rated cross-section	1.5 mm ²
Touch-safe protection acc. to DIN VDE 57 106	Safe from finger touch	Touch-safe protection acc. to DIN VDE 0470	IP 20
Volume resistance	≤ 5mΩ	Can be coded	Yes
Stripping length	6 mm	Tightening torque, min.	0.2 Nm
Tightening torque, max.	0.25 Nm	Clamping screw	M 2
Screwdriver blade	0.4 x 2.5	Screwdriver blade standard	DIN 5264
Plugging cycles	25	Plugging force/pole, max.	7 N
Pulling force/pole, max.	5 N		

Material data

Insulating material	PBT	Colour	orange
Colour chart (similar)	RAL 2000	Insulating material group	IIIa
Comparative Tracking Index (CTI)	≥ 200	Insulation strength	≥ 10 ⁸ Ω
UL 94 flammability rating	V-0	GWFI	960 °C
Contact material	Copper alloy	Contact surface	tinned
Layer structure of plug contact	4-8 μm Sn hot-dip tinned	Storage temperature, min.	-25 °C
Storage temperature, max.	50 °C	Max. relative humidity during storage	70 %
Operating temperature, min.	-50 °C	Operating temperature, max.	100 °C
Temperature range, installation, min.	-30 °C	Temperature range, installation, max.	100 °C

Conductors suitable for connection

Clamping range, min.	0.08 mm ²
Clamping range, max.	1.5 mm ²
Wire connection cross section AWG, min.	AWG 28
Wire connection cross section AWG, max.	AWG 14
Solid, min. H05(07) V-U	0.2 mm ²
Solid, max. H05(07) V-U	1.5 mm ²
Flexible, min. H05(07) V-K	0.2 mm ²
Flexible, max. H05(07) V-K	1.5 mm ²
w. plastic collar ferrule, DIN 46228 pt 4, 0.2 mm ² min.	
w. plastic collar ferrule, DIN 46228 pt 4, 1.5 mm ² max.	
w. wire end ferrule, DIN 46228 pt 1, 0.2 mm ² min.	
w. wire end ferrule, DIN 46228 pt 1, 1.5 mm ² max.	

Creation date May 3, 2020 2:15:27 PM CEST

OMNIMATE Signal - series BL/SL 3.50
BL 3.50/07/180LH SN OR BX

Weidmüller Interface GmbH & Co. KG
 Klingenbergstraße 26
 D-32758 Detmold
 Germany
 Fon: +49 5231 14-0
 Fax: +49 5231 14-292083
 www.weidmueller.com

Technical data

Plug gauge in accordance with EN 60999 a x b; ø 2.4 mm x 1.5 mm

Clampable conductor	Cross-section for conductor connection	Type	fine-wired
		nominal	0.5 mm ²
wire end ferrule		Stripping length	nominal 8 mm
		Recommended wire-end ferrule	H0.5/12 OR
		Stripping length	nominal 6 mm
		Recommended wire-end ferrule	H0.5/6
Cross-section for conductor connection	Type	fine-wired	
	nominal	0.75 mm ²	
wire end ferrule		Stripping length	nominal 8 mm
		Recommended wire-end ferrule	H0.75/12 W
		Stripping length	nominal 6 mm
		Recommended wire-end ferrule	H0.75/6
Cross-section for conductor connection	Type	fine-wired	
	nominal	1 mm ²	
wire end ferrule		Stripping length	nominal 8 mm
		Recommended wire-end ferrule	H1.0/12 GE
		Stripping length	nominal 6 mm
		Recommended wire-end ferrule	H1.0/6
Cross-section for conductor connection	Type	fine-wired	
	nominal	0.25 mm ²	
wire end ferrule		Stripping length	nominal 8 mm
		Recommended wire-end ferrule	H0.25/10 HBL
		Stripping length	nominal 5 mm
		Recommended wire-end ferrule	H0.25/5
Cross-section for conductor connection	Type	fine-wired	
	nominal	0.34 mm ²	
wire end ferrule		Stripping length	nominal 8 mm
		Recommended wire-end ferrule	H0.34/10 TK

Reference text The outside diameter of the plastic collar should not be larger than the pitch (P). Length of ferrules is to be chosen depending on the product and the rated voltage.

Max. clamping range 1.5 mm²

Rated data acc. to IEC

tested acc. to standard	IEC 60664-1, IEC 61984	Rated current, min. number of poles (Tu=20°C)	17 A
Rated current, max. number of poles (Tu=20°C)	12 A	Rated current, min. number of poles (Tu=40°C)	14.5 A
Rated current, max. number of poles (Tu=40°C)	10 A	Rated voltage for surge voltage class / pollution degree II/2	320 V
Rated voltage for surge voltage class / pollution degree III/2	160 V	Rated voltage for surge voltage class / pollution degree III/3	160 V
Rated impulse voltage for surge voltage class/ pollution degree II/2	320 V	Rated impulse voltage for surge voltage class/ pollution degree III/2	160 V
Rated impulse voltage for surge voltage class/ contamination degree III/3	160 V	Short-time withstand current resistance	3 x 1s with 100 A

OMNIMATE Signal - series BL/SL 3.50
BL 3.50/07/180LH SN OR BX

Weidmüller Interface GmbH & Co. KG
 Klingenbergstraße 26
 D-32758 Detmold
 Germany
 Fon: +49 5231 14-0
 Fax: +49 5231 14-292083
 www.weidmueller.com

Technical data
Rated data acc. to CSA

Rated voltage (Use group B / CSA)	300 V	Rated voltage (Use group D / CSA)	300 V
Rated current (Use group B / CSA)	10 A	Rated current (Use group D / CSA)	10 A
Wire cross-section, AWG, min.	AWG 28	Wire cross-section, AWG, max.	AWG 14

Rated data acc. to UL 1059

Institute (UR)		Certificate No. (UR)	E60693
Rated voltage (Use group B / UL 1059)	300 V	Rated voltage (Use group D / UL 1059)	300 V
Rated current (Use group B / UL 1059)	10 A	Rated current (Use group D / UL 1059)	10 A
Wire cross-section, AWG, min.	AWG 28	Wire cross-section, AWG, max.	AWG 14
Reference to approval values	Specifications are maximum values, details - see approval certificate.		

Packing

Packaging	Box	VPE length	67 mm
VPE width	88 mm	VPE height	143 mm

Classifications

ETIM 6.0	EC002638	ETIM 7.0	EC002638
eClass 9.0	27-44-03-09	eClass 9.1	27-44-03-09
eClass 10.0	27-44-03-09	UNSPSC	30-21-18-10

Notes

Notes	<ul style="list-style-type: none"> • Additional colours on request • Gold-plated contact surfaces on request • Rated current related to rated cross-section & min. No. of poles. • Max. outer diameter of the conductor: 2.9 mm • Wire end ferrule without plastic collar to DIN 46228/1 • Wire end ferrule with plastic collar to DIN 46228/4 • P on drawing = pitch • Rated data refer only to the component itself. Clearance and creepage distances to other components are to be designed in accordance with the relevant application standards.
IPC conformity	Conformity: The products are developed, manufactured and delivered according international recognized standards and norms and comply with the assured properties in the data sheet resp. fulfill decorative properties in accordance with IPC-A-610 "Class 2". Further claims on the products can be evaluated on request.

Data sheet

**OMNIMATE Signal - series BL/SL 3.50
BL 3.50/07/180LH SN OR BX**

Weidmüller Interface GmbH & Co. KG
Klingenbergstraße 26
D-32758 Detmold
Germany
Fon: +49 5231 14-0
Fax: +49 5231 14-292083
www.weidmueller.com

Technical data

Approvals

Approvals



ROHS

Conform

Downloads

Approval/Certificate/Document of Conformity

[Declaration of the Manufacturer](#)

Brochure/Catalogue

- [FL DRIVES EN](#)
- [MB DEVICE MANUF. EN](#)
- [FL DRIVES DE](#)
- [CAT 2 PORTFOLIOGUIDE EN](#)
- [FL BUILDING SAFETY EN](#)
- [FL APPL LED LIGHTING EN](#)
- [FLIndustr.CONTROLS EN](#)
- [FL MACHINE SAFETY EN](#)
- [FL HEATING ELECTR EN](#)
- [FL APPL INVERTER EN](#)
- [FL_BASE_STATION_EN](#)
- [FL ELEVATOR EN](#)
- [FL POWER SUPPLY EN](#)
- [FL 72H SAMPLE SER EN](#)
- [PO OMNIMATE EN](#)

Engineering Data

[STEP](#)

Product Change Notification

[Change of Material LR 3.50 - DE](#)
[Change of Material LR 3.50 - EN](#)

**OMNIMATE Signal - series BL/SL 3.50
BL 3.50/07/180LH SN OR BX**

Weidmüller Interface GmbH & Co. KG
Klingenbergstraße 26
D-32758 Detmold
Germany
Fon: +49 5231 14-0
Fax: +49 5231 14-292083
www.weidmueller.com

Drawings

Dimensional drawing

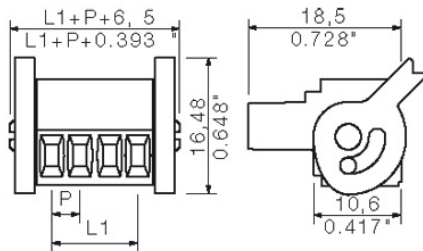

Graph

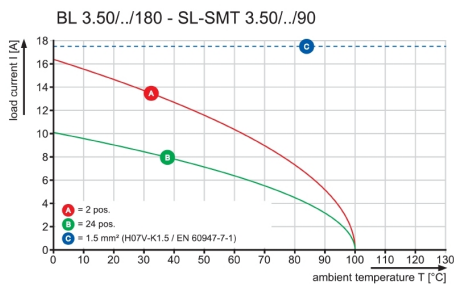

Graph

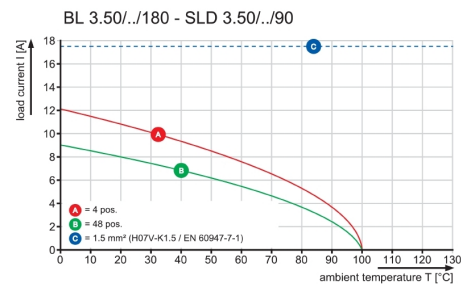

Graph

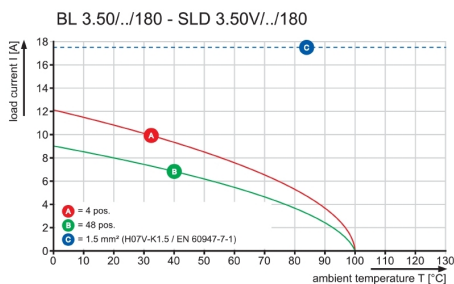

Graph

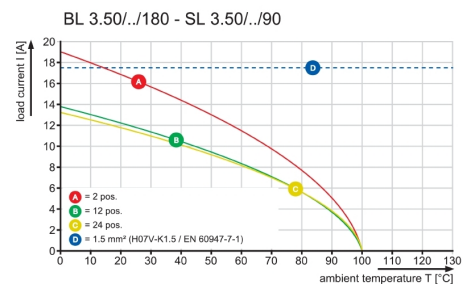

**OMNIMATE Signal - series BL/SL 3.50
BL 3.50/07/180LH SN OR BX**

Weidmüller Interface GmbH & Co. KG
Klingenbergstraße 26
D-32758 Detmold
Germany
Fon: +49 5231 14-0
Fax: +49 5231 14-292083
www.weidmueller.com

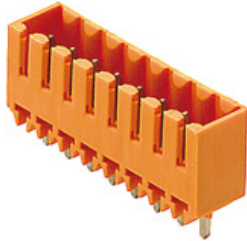
Mating connector (conditionally pluggable)
SL 3.50/180G

Pin headers for wave soldering in 3.50 mm pitch

- Plugging direction is parallel (90°), straight 180° or angled (135°) to the PCB
- Housing variant: screw flange (F)
- Packed in a cardboard box (BX)
- Pin header can be coded

General ordering data

Type	SL 3.50/07/180G 4.5SN B ...	Version	Product data	Packaging
Order No.	1616060000	PCB plug-in connector, male header, closed side, THT solder	IEC: 320 V / 17 A	Box
GTIN (EAN)	4008190065942	connection, 3.50 mm, Number of poles: 7, 180°, Solder pin length (l):	UL: 300 V / 10 A	
Qty.	50 pc(s).	4.5 mm, tinned, black, Box		
Type	SL 3.50/07/180G 3.2SN O ...	Version	Product data	Packaging
Order No.	1604520000	PCB plug-in connector, male header, closed side, THT solder	IEC: 320 V / 17 A	Box
GTIN (EAN)	4008190178727	connection, 3.50 mm, Number of poles: 7, 180°, Solder pin length (l):	UL: 300 V / 10 A	
Qty.	50 pc(s).	3.2 mm, tinned, orange, Box		

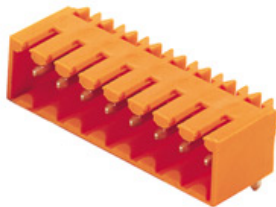
SL 3.50/90G

Pin headers for wave soldering in 3.50 mm pitch

- Plugging direction is parallel (90°), straight 180° or angled (135°) to the PCB
- Housing variant: screw flange (F)
- Packed in a cardboard box (BX)
- Pin header can be coded

General ordering data

Type	SL 3.50/07/90G 4.5SN BK ...	Version	Product data	Packaging
Order No.	1615450000	PCB plug-in connector, male header, closed side, THT solder	IEC: / 17 A	Box
GTIN (EAN)	4008190055578	connection, 3.50 mm, Number of poles: 7, 90°, Solder pin length (l):	UL: 300 V / 10 A	
Qty.	50 pc(s).	4.5 mm, tinned, black, Box		
Type	SL 3.50/07/90G 3.2SN DK ...	Version	Product data	Packaging
Order No.	1606950000	PCB plug-in connector, male header, closed side, THT solder	IEC: / 17 A	Box
GTIN (EAN)	4008190173678	connection, 3.50 mm, Number of poles: 7, 90°, Solder pin length (l):	UL: 300 V / 10 A	
Qty.	50 pc(s).	3.2 mm, tinned, Signal green, Box		
Type	SL 3.50/07/90G 4.5SN OR ...	Version	Product data	Packaging
Order No.	1605270000	PCB plug-in connector, male header, closed side, THT solder	IEC: / 17 A	Box
GTIN (EAN)	4008190069599	connection, 3.50 mm, Number of poles: 7, 90°, Solder pin length (l):	UL: 300 V / 10 A	
Qty.	50 pc(s).	4.5 mm, tinned, orange, Box		
Type	SL 3.50/07/90G 3.2SN GY ...	Version	Product data	Packaging
Order No.	1619510000	PCB plug-in connector, male header, closed side, THT solder	IEC: / 17 A	Box
GTIN (EAN)	4008190141370	connection, 3.50 mm, Number of poles: 7, 90°, Solder pin length (l):	UL: 300 V / 10 A	
Qty.	50 pc(s).	3.2 mm, tinned, Pebble grey, Box		

**OMNIMATE Signal - series BL/SL 3.50
BL 3.50/07/180LH SN OR BX**

Weidmüller Interface GmbH & Co. KG
Klingenbergstraße 26
D-32758 Detmold
Germany
Fon: +49 5231 14-0
Fax: +49 5231 14-292083
www.weidmueller.com

Mating connector (conditionally pluggable)

Type	SL 3.50/07/90G 3.2SN OR ...	Version	Product data	Packaging
Order No.	1605120000	PCB plug-in connector, male header, closed side, THT solder connection, 3.50 mm, Number of poles: 7, 90°, Solder pin length (l): 3.2 mm, tinned, orange, Box	IEC: / 17 A UL: 300 V / 10 A	Box
GTIN (EAN)	4008190169954			
Qty.	50 pc(s).			

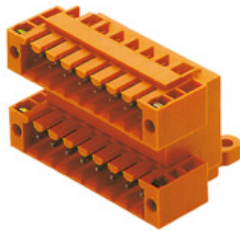
SLD 3.50/90F

Two-tier pin header for wave soldering in 3.50 mm pitch. The connector is available in open, closed and flange versions. The male connectors provide space for labelling and can be coded. Packed in a cardboard box.

General ordering data

Type	SLD 3.50/14/90F 3.2SN O ...	Version	Product data	Packaging
Order No.	1633860000	PCB plug-in connector, male header, Flange, THT solder connection, 3.50 mm, Number of poles: 14, 90°, Solder pin length (l): 3.2 mm, tinned, orange, Box	IEC: 200 V / 10.5 A UL: 300 V / 8 A	Box
GTIN (EAN)	4008190258313			
Qty.	20 pc(s).			

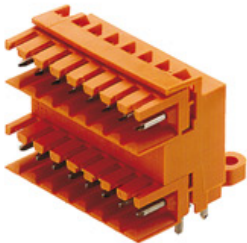
SLD 3.50/90

Two-tier pin header for wave soldering in 3.50 mm pitch. The connector is available in open, closed and flange versions. The male connectors provide space for labelling and can be coded. Packed in a cardboard box.

General ordering data

Type	SLD 3.50/14/90 3.2SN OR ...	Version	Product data	Packaging
Order No.	1633400000	PCB plug-in connector, male header, open side, THT solder connection, 3.50 mm, Number of poles: 14, 90°, Solder pin length (l): 3.2 mm, tinned, orange, Box	IEC: 200 V / 10.5 A UL: 300 V / 8 A	Box
GTIN (EAN)	4008190257859			
Qty.	20 pc(s).			

**OMNIMATE Signal - series BL/SL 3.50
BL 3.50/07/180LH SN OR BX**

Weidmüller Interface GmbH & Co. KG
Klingenbergstraße 26
D-32758 Detmold
Germany
Fon: +49 5231 14-0
Fax: +49 5231 14-292083
www.weidmueller.com

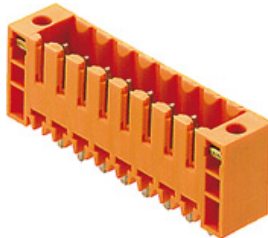
Mating connector (conditionally pluggable)
SL 3.50/180F

Pin headers for wave soldering in 3.50 mm pitch

- Plugging direction is parallel (90°), straight 180° or angled (135°) to the PCB
- Housing variant: screw flange (F)
- Packed in a cardboard box (BX)
- Pin header can be coded

General ordering data

Type	SL 3.50/07/180F 3.2SN D ...	Version	Product data	Packaging
Order No.	1622530000	PCB plug-in connector, male header, Flange, THT solder connection,	IEC: 320 V / 17 A	Box
GTIN (EAN)	4008190193195	3.50 mm, Number of poles: 7, 180°, Solder pin length (l): 3.2 mm,	UL: 300 V / 10 A	
Qty.	50 pc(s).	tinned, Signal green, Box		
Type	SL 3.50/07/180F 4.5SN O ...	Version	Product data	Packaging
Order No.	1618740000	PCB plug-in connector, male header, Flange, THT solder connection,	IEC: 320 V / 17 A	Box
GTIN (EAN)	4008190127329	3.50 mm, Number of poles: 7, 180°, Solder pin length (l): 4.5 mm,	UL: 300 V / 10 A	
Qty.	50 pc(s).	tinned, orange, Box		
Type	SL 3.50/07/180F 4.5SN B ...	Version	Product data	Packaging
Order No.	1616190000	PCB plug-in connector, male header, Flange, THT solder connection,	IEC: 320 V / 17 A	Box
GTIN (EAN)	4008190068462	3.50 mm, Number of poles: 7, 180°, Solder pin length (l): 4.5 mm,	UL: 300 V / 10 A	
Qty.	50 pc(s).	tinned, black, Box		
Type	SL 3.50/07/180F 3.2SN G ...	Version	Product data	Packaging
Order No.	1622310000	PCB plug-in connector, male header, Flange, THT solder connection,	IEC: 320 V / 17 A	Box
GTIN (EAN)	4008190190019	3.50 mm, Number of poles: 7, 180°, Solder pin length (l): 3.2 mm,	UL: 300 V / 10 A	
Qty.	50 pc(s).	tinned, Pebble grey, Box		
Type	SL 3.50/07/180F 3.2SN O ...	Version	Product data	Packaging
Order No.	1607550000	PCB plug-in connector, male header, Flange, THT solder connection,	IEC: 320 V / 17 A	Box
GTIN (EAN)	4008190060343	3.50 mm, Number of poles: 7, 180°, Solder pin length (l): 3.2 mm,	UL: 300 V / 10 A	
Qty.	50 pc(s).	tinned, orange, Box		

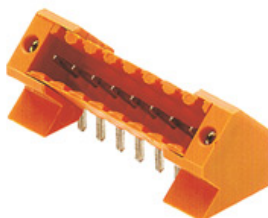
SL 3.50/135F

Pin headers for wave soldering in 3.50 mm pitch

- Plugging direction is parallel (90°), straight 180° or angled (135°) to the PCB
- Housing variant: screw flange (F)
- Packed in a cardboard box (BX)
- Pin header can be coded

General ordering data

Type	SL 3.50/07/135F 3.2SN O ...	Version	Product data	Packaging
Order No.	1643380000	PCB plug-in connector, male header, Flange, THT solder connection,	IEC: 320 V / 15 A	Box
GTIN (EAN)	4008190282141	3.50 mm, Number of poles: 7, 135°, Solder pin length (l): 3.2 mm,	UL: 300 V / 10 A	
Qty.	54 pc(s).	tinned, orange, Box		

**OMNIMATE Signal - series BL/SL 3.50
BL 3.50/07/180LH SN OR BX**

Weidmüller Interface GmbH & Co. KG
Klingenbergstraße 26
D-32758 Detmold
Germany
Fon: +49 5231 14-0
Fax: +49 5231 14-292083
www.weidmueller.com

Mating connector (conditionally pluggable)
SL-SMT 3.5/90G Tray

High-temperature-resistant male header, 3.50 mm pitch.

- **Plugging direction parallel (90°), straight 180° or angled (135°) to PCB**
- **Housing variants: closed side (G), screw flange (F), solder flange (LF) or snap-on solder flange (RF)**
- **Optimised for the SMT process**
- **Pin length 3.2 mm universal for all soldering methods**
- **Pin length 1.5 mm optimised for reflow soldering methods**
- **Packed either in a box (BX) or tape-on-reel (RL)**
- **Male header can be coded**

General ordering data

Type	SL-SMT 3.50/07/90G 1.5S ...	Version	Product data	Packaging
Order No.	1761593001	PCB plug-in connector, male header, closed side, THT/THR solder connection, 3.50 mm, Number of poles: 7, 90°, Solder pin length (l): 1.5 mm, tinned, black, Tray	IEC: 320 V / 15 A UL: 300 V / 10 A	Tray
GTIN (EAN)	4032248133864			
Qty.	60 pc(s).			

SL-SMT 3.5/90G Tape

High-temperature-resistant male header, 3.50 mm pitch.

- **Plugging direction parallel (90°), straight 180° or angled (135°) to PCB**
- **Housing variants: closed side (G), screw flange (F), solder flange (LF) or snap-on solder flange (RF)**
- **Optimised for the SMT process**
- **Pin length 3.2 mm universal for all soldering methods**
- **Pin length 1.5 mm optimised for reflow soldering methods**
- **Packed either in a box (BX) or tape-on-reel (RL)**
- **Male header can be coded**

General ordering data

Type	SL-SMT 3.50/07/90G 1.5S ...	Version	Product data	Packaging
Order No.	1761594001	PCB plug-in connector, male header, closed side, THT/THR solder connection, 3.50 mm, Number of poles: 7, 90°, Solder pin length (l): 1.5 mm, tinned, black, Tape	IEC: 320 V / 15 A UL: 300 V / 10 A	Tape
GTIN (EAN)	4032248136032			
Qty.	385 pc(s).			

**OMNIMATE Signal - series BL/SL 3.50
BL 3.50/07/180LH SN OR BX**

Weidmüller Interface GmbH & Co. KG
Klingenbergstraße 26
D-32758 Detmold
Germany
Fon: +49 5231 14-0
Fax: +49 5231 14-292083
www.weidmueller.com

Mating connector (conditionally pluggable)
SL-THR 3.5/135F

High-temperature-resistant male header, 3.50 mm pitch.

- **Plugging direction parallel (90°), straight 180° or angled (135°) to PCB**
- **Housing variants: closed side (G), screw flange (F), solder flange (LF) or snap-on solder flange (RF)**
- **Optimised for the SMT process**
- **Pin length 3.2 mm universal for all soldering methods**
- **Pin length 1.5 mm optimised for reflow soldering methods**
- **Packed either in a box (BX) or tape-on-reel (RL)**
- **Male header can be coded**

General ordering data

Type	SL-SMT 3.50/07/135F 3.2 ...	Version	Product data	Packaging
Order No.	1003560000	PCB plug-in connector, male header, Flange, THT/THR solder connection, 3.50 mm, Number of poles: 7, 135°, Solder pin length (l): 3.2 mm, tinned, black, Box	IEC: 320 V / 15 A UL: 300 V / 10 A	Box
GTIN (EAN)	4032248700189			
Qty.	54 pc(s).			

SL-SMT 3.5/180G Tape

High-temperature-resistant male header, 3.50 mm pitch.

- **Plugging direction parallel (90°), straight 180° or angled (135°) to PCB**
- **Housing variants: closed side (G), screw flange (F), solder flange (LF) or snap-on solder flange (RF)**
- **Optimised for the SMT process**
- **Pin length 3.2 mm universal for all soldering methods**
- **Pin length 1.5 mm optimised for reflow soldering methods**
- **Packed either in a box (BX) or tape-on-reel (RL)**
- **Male header can be coded**

General ordering data

Type	SL-SMT 3.50/07/180G 1.5 ...	Version	Product data	Packaging
Order No.	1753034001	PCB plug-in connector, male header, closed side, THT/THR solder connection, 3.50 mm, Number of poles: 7, 180°, Solder pin length (l): 1.5 mm, tinned, black, Tape	IEC: 320 V / 15 A UL: 300 V / 10 A	Tape
GTIN (EAN)	4032248135639			
Qty.	265 pc(s).			

**OMNIMATE Signal - series BL/SL 3.50
BL 3.50/07/180LH SN OR BX**

Weidmüller Interface GmbH & Co. KG
Klingenbergstraße 26
D-32758 Detmold
Germany
Fon: +49 5231 14-0
Fax: +49 5231 14-292083
www.weidmueller.com

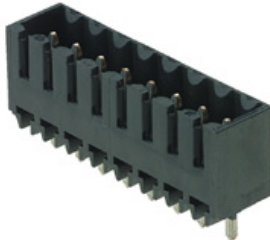
Mating connector (conditionally pluggable)
SL-SMT 3.5/180G Box

High-temperature-resistant male header, 3.50 mm pitch.

- **Plugging direction parallel (90°), straight 180° or angled (135°) to PCB**
- **Housing variants: closed side (G), screw flange (F), solder flange (LF) or snap-on solder flange (RF)**
- **Optimised for the SMT process**
- **Pin length 3.2 mm universal for all soldering methods**
- **Pin length 1.5 mm optimised for reflow soldering methods**
- **Packed either in a box (BX) or tape-on-reel (RL)**
- **Male header can be coded**

General ordering data

Type	SL-SMT 3.50/07/180G 1.5 ...	Version	Product data	Packaging
Order No.	1753032001	PCB plug-in connector, male header, closed side, THT/THR solder connection, 3.50 mm, Number of poles: 7, 180°, Solder pin length (l): 1.5 mm, tinned, black, Box	IEC: 320 V / 15 A UL: 300 V / 10 A	Box
GTIN (EAN)	4032248130931			
Qty.	50 pc(s).			
Type	SL-SMT 3.50/07/180G 3.2 ...	Version	Product data	Packaging
Order No.	1842370000	PCB plug-in connector, male header, closed side, THT/THR solder connection, 3.50 mm, Number of poles: 7, 180°, Solder pin length (l): 3.2 mm, tinned, black, Box	IEC: 320 V / 15 A UL: 300 V / 10 A	Box
GTIN (EAN)	4032248353729			
Qty.	50 pc(s).			

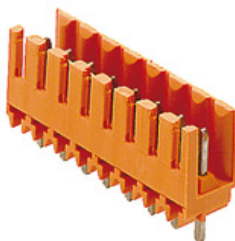
SL 3.50/180

Pin headers for wave soldering in 3.50 mm pitch

- **Plugging direction is parallel (90°), straight 180° or angled (135°) to the PCB**
- **Housing variant: screw flange (F)**
- **Packed in a cardboard box (BX)**
- **Pin header can be coded**

General ordering data

Type	SL 3.50/07/180 3.2SN OR ...	Version	Product data	Packaging
Order No.	1604820000	PCB plug-in connector, male header, open side, THT solder connection, 3.50 mm, Number of poles: 7, 180°, Solder pin length (l): 3.2 mm, tinned, orange, Box	IEC: 320 V / 17 A UL: 300 V / 10 A	Box
GTIN (EAN)	4008190176129			
Qty.	50 pc(s).			

**OMNIMATE Signal - series BL/SL 3.50
BL 3.50/07/180LH SN OR BX**

Weidmüller Interface GmbH & Co. KG
Klingenbergstraße 26
D-32758 Detmold
Germany
Fon: +49 5231 14-0
Fax: +49 5231 14-292083
www.weidmueller.com

Mating connector (conditionally pluggable)
SL-SMT 3.5/180G Tray

High-temperature-resistant male header, 3.50 mm pitch.

- **Plugging direction parallel (90°), straight 180° or angled (135°) to PCB**
- **Housing variants: closed side (G), screw flange (F), solder flange (LF) or snap-on solder flange (RF)**
- **Optimised for the SMT process**
- **Pin length 3.2 mm universal for all soldering methods**
- **Pin length 1.5 mm optimised for reflow soldering methods**
- **Packed either in a box (BX) or tape-on-reel (RL)**
- **Male header can be coded**

General ordering data

Type	SL-SMT 3.50/07/180G 1.5 ...	Version	Product data	Packaging
Order No.	1753033001	PCB plug-in connector, male header, closed side, THT/THR solder connection, 3.50 mm, Number of poles: 7, 180°, Solder pin length (l): 1.5 mm, tinned, black, Tray	IEC: 320 V / 15 A UL: 300 V / 10 A	Tray
GTIN (EAN)	4032248132768			
Qty.	60 pc(s).			

SL-SMT 3.5/90G Box

High-temperature-resistant male header, 3.50 mm pitch.

- **Plugging direction parallel (90°), straight 180° or angled (135°) to PCB**
- **Housing variants: closed side (G), screw flange (F), solder flange (LF) or snap-on solder flange (RF)**
- **Optimised for the SMT process**
- **Pin length 3.2 mm universal for all soldering methods**
- **Pin length 1.5 mm optimised for reflow soldering methods**
- **Packed either in a box (BX) or tape-on-reel (RL)**
- **Male header can be coded**

General ordering data

Type	SL-SMT 3.50/07/90G 1.5S ...	Version	Product data	Packaging
Order No.	1761592001	PCB plug-in connector, male header, closed side, THT/THR solder connection, 3.50 mm, Number of poles: 7, 90°, Solder pin length (l): 1.5 mm, tinned, black, Box	IEC: 320 V / 15 A UL: 300 V / 10 A	Box
GTIN (EAN)	4032248132089			
Qty.	50 pc(s).			

**OMNIMATE Signal - series BL/SL 3.50
BL 3.50/07/180LH SN OR BX**

Weidmüller Interface GmbH & Co. KG
Klingenbergstraße 26
D-32758 Detmold
Germany
Fon: +49 5231 14-0
Fax: +49 5231 14-292083
www.weidmueller.com

Mating connector (conditionally pluggable)

Type	SL-SMT 3.50/07/90G 3.2S ...	Version	Product data	Packaging
Order No.	1841680000	PCB plug-in connector, male header, closed side, THT/THR solder connection, 3.50 mm, Number of poles: 7, 90°, Solder pin length (l): 3.2 mm, tinned, black, Box	IEC: 320 V / 15 A UL: 300 V / 10 A	Box
GTIN (EAN)	4032248353033			
Qty.	50 pc(s).			

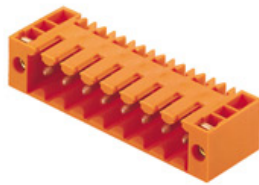
SL 3.50/90F

Pin headers for wave soldering in 3.50 mm pitch

- Plugging direction is parallel (90°), straight 180° or angled (135°) to the PCB
- Housing variant: screw flange (F)
- Packed in a cardboard box (BX)
- Pin header can be coded

General ordering data

Type	SL 3.50/07/90F 3.2SN OR ...	Version	Product data	Packaging
Order No.	1607090000	PCB plug-in connector, male header, Flange, THT solder connection, 3.50 mm, Number of poles: 7, 90°, Solder pin length (l): 3.2 mm, tinned, orange, Box	IEC: / 17 A UL: 300 V / 10 A	Box
GTIN (EAN)	4008190184216			
Qty.	50 pc(s).			
Type	SL 3.50/07/90F 4.5SN OR ...	Version	Product data	Packaging
Order No.	1618110000	PCB plug-in connector, male header, Flange, THT solder connection, 3.50 mm, Number of poles: 7, 90°, Solder pin length (l): 4.5 mm, tinned, orange, Box	IEC: / 17 A UL: 300 V / 10 A	Box
GTIN (EAN)	4008190116392			
Qty.	50 pc(s).			
Type	SL 3.50/07/90F 3.2SN DK ...	Version	Product data	Packaging
Order No.	1620110000	PCB plug-in connector, male header, Flange, THT solder connection, 3.50 mm, Number of poles: 7, 90°, Solder pin length (l): 3.2 mm, tinned, Signal green, Box	IEC: / 17 A UL: 300 V / 10 A	Box
GTIN (EAN)	4008190151775			
Qty.	50 pc(s).			
Type	SL 3.50/07/90F 3.2SN GY ...	Version	Product data	Packaging
Order No.	1619900000	PCB plug-in connector, male header, Flange, THT solder connection, 3.50 mm, Number of poles: 7, 90°, Solder pin length (l): 3.2 mm, tinned, Pebble grey, Box	IEC: / 17 A UL: 300 V / 10 A	Box
GTIN (EAN)	4008190149123			
Qty.	50 pc(s).			
Type	SL 3.50/07/90F 4.5SN BK ...	Version	Product data	Packaging
Order No.	1615580000	PCB plug-in connector, male header, Flange, THT solder connection, 3.50 mm, Number of poles: 7, 90°, Solder pin length (l): 4.5 mm, tinned, black, Box	IEC: / 17 A UL: 300 V / 10 A	Box
GTIN (EAN)	4008190057510			
Qty.	50 pc(s).			

**OMNIMATE Signal - series BL/SL 3.50
BL 3.50/07/180LH SN OR BX**

Weidmüller Interface GmbH & Co. KG
Klingenbergstraße 26
D-32758 Detmold
Germany
Fon: +49 5231 14-0
Fax: +49 5231 14-292083
www.weidmueller.com

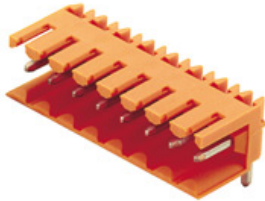
Mating connector (conditionally pluggable)
SL 3.50/90

Pin headers for wave soldering in 3.50 mm pitch

- Plugging direction is parallel (90°), straight 180° or angled (135°) to the PCB
- Housing variant: screw flange (F)
- Packed in a cardboard box (BX)
- Pin header can be coded

General ordering data

Type	SL 3.50/07/90 3.2SN DKG ...	Version	Product data	Packaging
Order No.	1606830000	PCB plug-in connector, male header, open side, THT solder connection, 3.50 mm, Number of poles: 7, 90°, Solder pin length (l): 3.2 mm, tinned, Signal green, Box	IEC: 320 V / 17 A UL: 300 V / 10 A	Box
GTIN (EAN)	4008190183684			
Qty.	50 pc(s).			
Type	SL 3.50/07/90 3.2SN OR ...	Version	Product data	Packaging
Order No.	1597260000	PCB plug-in connector, male header, open side, THT solder connection, 3.50 mm, Number of poles: 7, 90°, Solder pin length (l): 3.2 mm, tinned, orange, Box	IEC: 320 V / 17 A UL: 300 V / 10 A	Box
GTIN (EAN)	4008190044350			
Qty.	50 pc(s).			
Type	SL 3.50/07/90 3.2SN GY ...	Version	Product data	Packaging
Order No.	1619120000	PCB plug-in connector, male header, open side, THT solder connection, 3.50 mm, Number of poles: 7, 90°, Solder pin length (l): 3.2 mm, tinned, Pebble grey, Box	IEC: 320 V / 17 A UL: 300 V / 10 A	Box
GTIN (EAN)	4008190134440			
Qty.	50 pc(s).			
Type	SL 3.50/07/90 4.5SN OR ...	Version	Product data	Packaging
Order No.	1605420000	PCB plug-in connector, male header, open side, THT solder connection, 3.50 mm, Number of poles: 7, 90°, Solder pin length (l): 4.5 mm, tinned, orange, Box	IEC: 320 V / 17 A UL: 300 V / 10 A	Box
GTIN (EAN)	4008190136468			
Qty.	50 pc(s).			
Type	SL 3.50/07/90 4.5SN BK ...	Version	Product data	Packaging
Order No.	1615340000	PCB plug-in connector, male header, open side, THT solder connection, 3.50 mm, Number of poles: 7, 90°, Solder pin length (l): 4.5 mm, tinned, black, Box	IEC: 320 V / 17 A UL: 300 V / 10 A	Box
GTIN (EAN)	4008190052959			
Qty.	50 pc(s).			

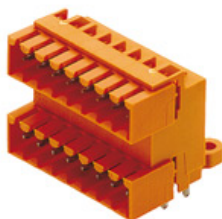
SLD 3.50/90G

Two-tier pin header for wave soldering in 3.50 mm pitch. The connector is available in open, closed and flange versions. The male connectors provide space for labelling and can be coded. Packed in a cardboard box.

General ordering data

Type	SLD 3.50/14/90G 3.2SN O ...	Version	Product data	Packaging
Order No.	1633630000	PCB plug-in connector, male header, closed side, THT solder connection, 3.50 mm, Number of poles: 14, 90°, Solder pin length (l): 3.2 mm, tinned, orange, Box	IEC: 200 V / 10.5 A UL: 300 V / 8 A	Box
GTIN (EAN)	4008190258085			
Qty.	20 pc(s).			

**OMNIMATE Signal - series BL/SL 3.50
BL 3.50/07/180LH SN OR BX**

Weidmüller Interface GmbH & Co. KG
 Klingenbergstraße 26
 D-32758 Detmold
 Germany
 Fon: +49 5231 14-0
 Fax: +49 5231 14-292083
 www.weidmueller.com

Mating connector (conditionally pluggable)

Type	SLD 3.50/14/90G 4.5SN B ...	Version	Product data	Packaging
Order No.	1634320000	PCB plug-in connector, male header, closed side, THT solder	IEC: 200 V / 10.5 A	Box
GTIN (EAN)	4008190258771	connection, 3.50 mm, Number of poles: 14, 90°, Solder pin length (!):	UL: 300 V / 8 A	
Qty.	20 pc(s).	4.5 mm, tinned, black, Box		
Type	SLD 3.50/14/90G 3.2SN D ...	Version	Product data	Packaging
Order No.	1674920000	PCB plug-in connector, male header, closed side, THT solder	IEC: 200 V / 10.5 A	Box
GTIN (EAN)	4008190445614	connection, 3.50 mm, Number of poles: 14, 90°, Solder pin length (!):	UL: 300 V / 8 A	
Qty.	20 pc(s).	3.2 mm, tinned, Signal green, Box		

**OMNIMATE Signal - series BL/SL 3.50
BL 3.50/07/180LH SN OR BX**

Weidmüller Interface GmbH & Co. KG
Klingenbergstraße 26
D-32758 Detmold
Germany
Fon: +49 5231 14-0
Fax: +49 5231 14-292083
www.weidmuller.com

Mating connector (fully pluggable)
SL-SMT 3.50/90F Tape

High-temperature-resistant male header, 3.50 mm pitch.

- **Plugging direction parallel (90°), straight 180° or angled (135°) to PCB**
- **Housing variants: closed side (G), screw flange (F), solder flange (LF) or snap-on solder flange (RF)**
- **Optimised for the SMT process**
- **Pin length 3.2 mm universal for all soldering methods**
- **Pin length 1.5 mm optimised for reflow soldering methods**
- **Packed either in a box (BX) or tape-on-reel (RL)**
- **Male header can be coded**

General ordering data

Type	SL-SMT 3.50/07/90F 1.5S ...	Version	Product data	Packaging
Order No.	1762054001	PCB plug-in connector, male header, Flange, THT/THR solder connection, 3.50 mm, Number of poles: 7, 90°, Solder pin length (l): 1.5 mm, tinned, black, Tape	IEC: 320 V / 15 A UL: 300 V / 10 A	Tape
GTIN (EAN)	4032248136230			
Qty.	385 pc(s).			

SL-SMT 3.5/90LF Box

High-temperature-resistant male header, 3.50 mm pitch.

- **Plugging direction parallel (90°), straight 180° or angled (135°) to PCB**
- **Housing variants: closed side (G), screw flange (F), solder flange (LF) or snap-on solder flange (RF)**
- **Optimised for the SMT process**
- **Pin length 3.2 mm universal for all soldering methods**
- **Pin length 1.5 mm optimised for reflow soldering methods**
- **Packed either in a box (BX) or tape-on-reel (RL)**
- **Male header can be coded**

General ordering data

Type	SL-SMT 3.50/07/90LF 1.5 ...	Version	Product data	Packaging
Order No.	1804990000	PCB plug-in connector, male header, Solder flange, THT/THR solder connection, 3.50 mm, Number of poles: 7, 90°, Solder pin length (l): 1.5 mm, tinned, black, Box	IEC: 320 V / 15 A UL: 300 V / 10 A	Box
GTIN (EAN)	4032248268894			
Qty.	54 pc(s).			

OMNIMATE Signal - series BL/SL 3.50 BL 3.50/07/180LH SN OR BX

Weidmüller Interface GmbH & Co. KG
 Klingenbergstraße 26
 D-32758 Detmold
 Germany
 Fon: +49 5231 14-0
 Fax: +49 5231 14-292083
 www.weidmueller.com

Mating connector (fully pluggable)

Type	SL-SMT 3.50/07/90LF 3.2 ...	Version	Product data	Packaging
Order No.	1841910000	PCB plug-in connector, male header, Solder flange, THT/THR solder	IEC: 320 V / 15 A	Box
GTIN (EAN)	4032248353262	connection, 3.50 mm, Number of poles: 7, 90°, Solder pin length (l):	UL: 300 V / 10 A	
Qty.	54 pc(s).	3.2 mm, tinned, black, Box		

SL-SMT 3.5/180F Box



High-temperature-resistant male header, 3.50 mm pitch.

- **Plugging direction parallel (90°), straight 180° or angled (135°) to PCB**
- **Housing variants: closed side (G), screw flange (F), solder flange (LF) or snap-on solder flange (RF)**
- **Optimised for the SMT process**
- **Pin length 3.2 mm universal for all soldering methods**
- **Pin length 1.5 mm optimised for reflow soldering methods**
- **Packed either in a box (BX) or tape-on-reel (RL)**
- **Male header can be coded**

General ordering data

Type	SL-SMT 3.50/07/180F 3.2 ...	Version	Product data	Packaging
Order No.	1842820000	PCB plug-in connector, male header, Flange, THT/THR solder	IEC: 320 V / 15 A	Box
GTIN (EAN)	4032248354184	connection, 3.50 mm, Number of poles: 7, 180°, Solder pin length (l):	UL: 300 V / 10 A	
Qty.	54 pc(s).	3.2 mm, tinned, black, Box		

**OMNIMATE Signal - series BL/SL 3.50
BL 3.50/07/180LH SN OR BX**

Weidmüller Interface GmbH & Co. KG
Klingenbergstraße 26
D-32758 Detmold
Germany
Fon: +49 5231 14-0
Fax: +49 5231 14-292083
www.weidmuller.com

Mating connector (fully pluggable)
SL-SMT 3.5/180LF Tape

High-temperature-resistant male header, 3.50 mm pitch.

- **Plugging direction parallel (90°), straight 180° or angled (135°) to PCB**
- **Housing variants: closed side (G), screw flange (F), solder flange (LF) or snap-on solder flange (RF)**
- **Optimised for the SMT process**
- **Pin length 3.2 mm universal for all soldering methods**
- **Pin length 1.5 mm optimised for reflow soldering methods**
- **Packed either in a box (BX) or tape-on-reel (RL)**
- **Male header can be coded**

General ordering data

Type	SL-SMT 3.50/07/180LF 1. ...	Version	Product data	Packaging
Order No.	1805280000	PCB plug-in connector, male header, Solder flange, THT/THR solder	IEC: 320 V / 15 A	Tape
GTIN (EAN)	4032248269549	connection, 3.50 mm, Number of poles: 7, 180°, Solder pin length (l):	UL: 300 V / 10 A	
Qty.	265 pc(s).	1.5 mm, tinned, black, Tape		

SL-SMT 3.5/90F Box

High-temperature-resistant male header, 3.50 mm pitch.

- **Plugging direction parallel (90°), straight 180° or angled (135°) to PCB**
- **Housing variants: closed side (G), screw flange (F), solder flange (LF) or snap-on solder flange (RF)**
- **Optimised for the SMT process**
- **Pin length 3.2 mm universal for all soldering methods**
- **Pin length 1.5 mm optimised for reflow soldering methods**
- **Packed either in a box (BX) or tape-on-reel (RL)**
- **Male header can be coded**

General ordering data

Type	SL-SMT 3.50/07/90F 3.2S ...	Version	Product data	Packaging
Order No.	1842130000	PCB plug-in connector, male header, Flange, THT/THR solder	IEC: 320 V / 15 A	Box
GTIN (EAN)	4032248353484	connection, 3.50 mm, Number of poles: 7, 90°, Solder pin length (l):	UL: 300 V / 10 A	
Qty.	54 pc(s).	3.2 mm, tinned, black, Box		

**OMNIMATE Signal - series BL/SL 3.50
BL 3.50/07/180LH SN OR BX**

Weidmüller Interface GmbH & Co. KG
Klingenbergstraße 26
D-32758 Detmold
Germany
Fon: +49 5231 14-0
Fax: +49 5231 14-292083
www.weidmueller.com

Mating connector (fully pluggable)
SL-SMT 3.5/180LF Box

High-temperature-resistant male header, 3.50 mm pitch.

- **Plugging direction parallel (90°), straight 180° or angled (135°) to PCB**
- **Housing variants: closed side (G), screw flange (F), solder flange (LF) or snap-on solder flange (RF)**
- **Optimised for the SMT process**
- **Pin length 3.2 mm universal for all soldering methods**
- **Pin length 1.5 mm optimised for reflow soldering methods**
- **Packed either in a box (BX) or tape-on-reel (RL)**
- **Male header can be coded**

General ordering data

Type	SL-SMT 3.50/07/180LF 1. ...	Version	Product data	Packaging
Order No.	1804750000	PCB plug-in connector, male header, Solder flange, THT/THR solder connection, 3.50 mm, Number of poles: 7, 180°, Solder pin length (l): 1.5 mm, tinned, black, Box	IEC: 320 V / 15 A UL: 300 V / 10 A	Box
GTIN (EAN)	4032248268535			
Qty.	50 pc(s).			
Type	SL-SMT 3.50/07/180LF 3. ...	Version	Product data	Packaging
Order No.	1842590000	PCB plug-in connector, male header, Solder flange, THT/THR solder connection, 3.50 mm, Number of poles: 7, 180°, Solder pin length (l): 3.2 mm, tinned, black, Box	IEC: 320 V / 15 A UL: 300 V / 10 A	Box
GTIN (EAN)	4032248353958			
Qty.	54 pc(s).			

**OMNIMATE Signal - series BL/SL 3.50
BL 3.50/07/180LH SN OR BX**

Weidmüller Interface GmbH & Co. KG
Klingenbergstraße 26
D-32758 Detmold
Germany
Fon: +49 5231 14-0
Fax: +49 5231 14-292083
www.weidmueller.com

Mating connector (fully pluggable)
SL-SMT 3.5/90LF Tape

High-temperature-resistant male header, 3.50 mm pitch.

- **Plugging direction parallel (90°), straight 180° or angled (135°) to PCB**
- **Housing variants: closed side (G), screw flange (F), solder flange (LF) or snap-on solder flange (RF)**
- **Optimised for the SMT process**
- **Pin length 3.2 mm universal for all soldering methods**
- **Pin length 1.5 mm optimised for reflow soldering methods**
- **Packed either in a box (BX) or tape-on-reel (RL)**
- **Male header can be coded**

General ordering data

Type	SL-SMT 3.50/07/90LF 1.5 ...	Version	Product data	Packaging
Order No.	1805360000	PCB plug-in connector, male header, Solder flange, THT/THR solder connection, 3.50 mm, Number of poles: 7, 90°, Solder pin length (l):	IEC: 320 V / 15 A UL: 300 V / 10 A	Tape
GTIN (EAN)	4032248269716			
Qty.	385 pc(s).	1.5 mm, tinned, black, Tape		

OMNIMATE Signal - series BL/SL 3.50 BL 3.50/07/180LH SN OR BX

Weidmüller Interface GmbH & Co. KG
 Klingenbergstraße 26
 D-32758 Detmold
 Germany
 Fon: +49 5231 14-0
 Fax: +49 5231 14-292083
 www.weidmueller.com

Accessories

Cover hoods



Effective protection, optimised ergonomics and closed design:

From the strain relief on the connected conductors and the visual/contact protection and the disconnection aid: the optional retrofit hoods perform mechanical, visual and haptic functions.

The two half shells clip together securely, enclose the plug completely and offer the following functions:

- Cable ties or integrated cable clips provide strain relief.
- Marked with dekafix labels or adhesive strips
- Mounting side by side without losing poles or displacing the pitch
- Compatible: suitable for plugs with or without a flange or mounting bracket
- Flexible: 1-3 cable outlets leading in different directions available depending on the size

Weidmüller hoods offer added stability, better identification, complete compatibility and versatility. The result: maximum reliability and user-friendliness in any application.

General ordering data

Type	BL 3.50 AH07 BK BX	Version		Product data		Packaging	
Order No.	1745620000	PCB plug-in connector, Accessories, Hood, black, Number of poles: 7				Box	
GTIN (EAN)	4008190985189						
Qty.	10 pc(s).						

Strain reliefs



For frequent load changes: the "trailer coupling" for plug-in connectors.

The strain relief can do more than just relieve the strain on conductors:

Simply clip onto the plug and

- bundle conductors
- guide cables
- use as a connection and disconnection aid

No damage to the connecting points, clear, tidy wiring and easy to handle.

User advantages: permanent heavy-duty connections for harsh industrial environments and convenient operation ensure improved system availability.

General ordering data

Type	BL 3.50 ZE03 BK BX	Version		Product data		Packaging	
Order No.	1627820000	PCB plug-in connector, Accessories, Strain relief, black, Number of poles: 3				Box	
GTIN (EAN)	4008190202552						
Qty.	50 pc(s).						

Data sheet

OMNIMATE Signal - series BL/SL 3.50 BL 3.50/07/180LH SN OR BX

Weidmüller Interface GmbH & Co. KG
Klingenbergstraße 26
D-32758 Detmold
Germany
Fon: +49 5231 14-0
Fax: +49 5231 14-292083
www.weidmueller.com

Accessories

Type	BL 3.50 ZE03 OR BX	Version	Product data	Packaging
Order No.	1629680000	PCB plug-in connector, Accessories, Strain relief, orange, Number of		Box
GTIN (EAN)	4008190202569	poles: 3		
Qty.	50 pc(s).			

Coding elements



**Only connects what is supposed to be connected:
the right connection at the right place.**

Coding elements and locking devices clearly assign connecting elements during the manufacturing process and operation

The coding elements and locking devices are inserted prior to assembly or during the cable assembly phase. The Weidmüller alternative: configure online using the variant configurator to precode prior to delivery.

Incorrect assembly on the circuit board and incorrect plugging of connecting elements is no longer possible.

The advantage: no troubleshooting during manufacture and no operational errors by the user.

General ordering data

Type	BL SL 3.5 KO SW	Version	Product data	Packaging
Order No.	1610100000	PCB plug-in connector, Accessories, Coding element, black, Number		Box
GTIN (EAN)	4008190187637	of poles: 1		
Qty.	100 pc(s).			
Type	BL SL 3.5 KO OR	Version	Product data	Packaging
Order No.	1693430000	PCB plug-in connector, Accessories, Coding element, orange, Number		Box
GTIN (EAN)	4008190867447	of poles: 1		
Qty.	100 pc(s).			

DIE DEUTSCHE VERSION IST VERBINDLICH
THE GERMAN VERSION IS BINDING

WEITERGABE SOWIE VERVIELFÄLTIGUNG DIESES DOKUMENTS, VERWERTUNG UND MITTEILUNG SEINES INHALTS SIND VERBOTEN, SOWEIT NICHT AUSDRUECKLICH GESTATTET.
 ZUWIDERHANDLUNGEN VERPFLICHTEN ZU SCHADENERSATZ. ALLE RECHTE FUER DEN FALL DER PATENT-, GEBRAUCHSMUSTER- ODER GESCHMACKSMUSTERENTRAGUNG VORBEHALTEN.
 THE REPRODUCTION, DISTRIBUTION AND UTILIZATION OF THIS DOCUMENT AS WELL AS THE COMMUNICATION OF ITS CONTENTS TO OTHERS WITHOUT EXPLICIT AUTHORIZATION IS PROHIBITED.
 OFFENDERS WILL BE HELD LIABLE FOR THE PAYMENT OF DAMAGES. WEIDMUELLER EXCLUSIVELY RESERVES THE RIGHT TO FILE FOR PATENTS, UTILITY MODELS OR DESIGNS.
 © WEIDMUELLER INTERFACE GmbH & Co.KG

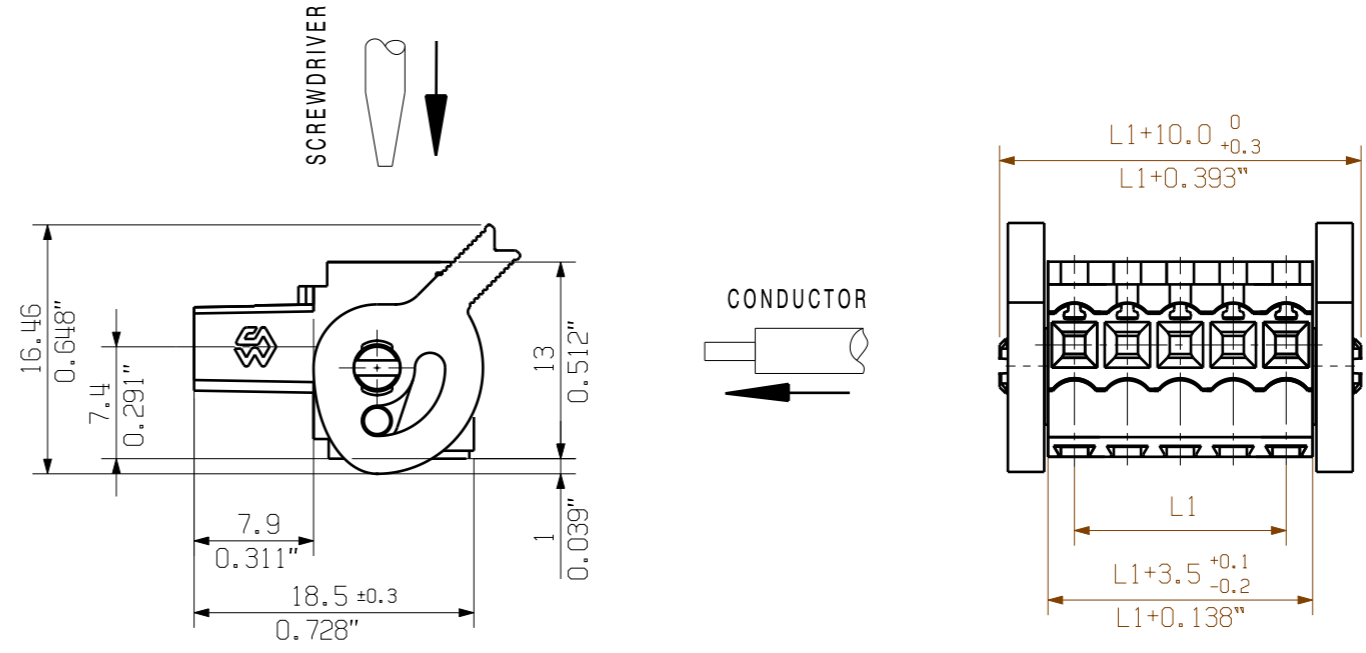

24	80,50	3,169
23	77,00	3,031
22	73,50	2,894
21	70,00	2,756
20	66,50	2,618
19	63,00	2,480
18	59,50	2,343
17	56,00	2,205
16	52,50	2,067
15	49,00	1,929
14	45,50	1,791
13	42,00	1,654
12	38,50	1,516
11	35,00	1,378
10	31,50	1,240
9	28,00	1,102
8	24,50	0,965
7	21,00	0,827
6	17,50	0,689
5	14,00	0,551
4	10,50	0,413
3	7,00	0,276
2	3,50	0,138
n	L1 [mm]	L1 [inch]

For the mounting of PCBs, it should be noted that the rated data given in the catalogue relates only to the connection elements. The necessary creepage and clearance paths must be observed in connection with the respective applicant in accordance to VDE 0110. The current-carrying capacity and pitch tolerance is to be determined according to DIN IEC 326 part 3 very fine.

Weidmüller PCB components are tested to the DIN VDE 0627 standard, and are valid for its field of application. Provided that the components are used to the intended purpose, all requirements with respect to the occurring of electrical, mechanical, thermic and corrosive stress will be satisfied.

SHOWN: BL 3.50/04/180/LH...

	DIN ISO 2768-m		69114/0 20.03.13 HELIS_MA 01			CAT.NO.:		
	MODIFICATION		DRAWING NO. C 22682			ISSUE NO. 11		
		DATE	NAME	SHEET 01 OF 02 SHEETS				
SCALE: 2/1		DRAWN	21.07.2009	HELIS_MA	BL 3.50/./180/ L(H/R) BUCHSENLEISTE SOCKET BLOCK			
SUPERSEDES: .		RESPONSIBLE		LANG_T				
		CHECKED	04.04.2013	HECKERT_M				
		APPROVED		HECKERT_M	PRODUCT FILE: BL 3.50 7382			