

## OMNIMATE Signal - series BL/SL 5.08 BLDT 5.08/03/-B SN OR BX

**Weidmüller Interface GmbH & Co. KG**  
Klingenbergstraße 26  
D-32758 Detmold  
Germany  
Fon: +49 5231 14-0  
Fax: +49 5231 14-292083  
www.weidmueller.com

### Product image

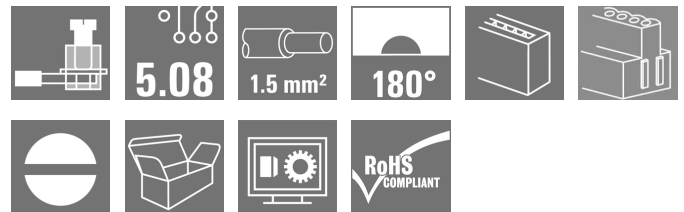
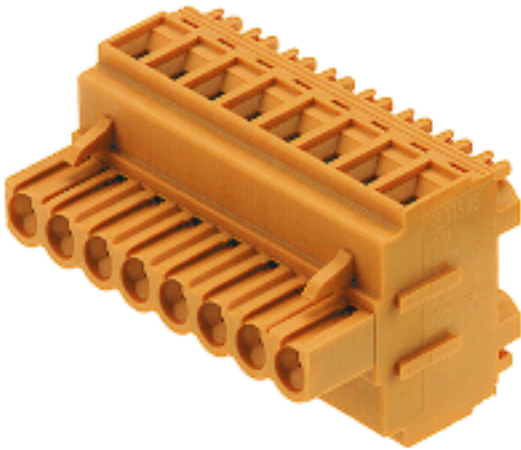

Similar to illustration

Female plugs with two clamping-yoke screw connections per pole for wire connections with 90° and 270° outlet directions. The female plugs provide space for labelling and can be coded.

### General ordering data

Type	BLDT 5.08/03/-B SN OR BX
Order No.	<a href="#">1651750000</a>
Version	PCB plug-in connector, female plug, 5.08 mm, Number of poles: 3, 180°, Clamping yoke connection, Clamping range, max. : 3.31 mm², Box
GTIN (EAN)	4008 190400439
Qty.	90 pc(s).
Product data	IEC: 400 V / 14 A / 0.2 - 2.5 mm² UL: 300 V / 10 A / AWG 26 - AWG 12
Packaging	Box

Creation date May 3, 2020 4:04:45 PM CEST

**OMNIMATE Signal - series BL/SL 5.08  
BLDT 5.08/03/-B SN OR BX**

**Weidmüller Interface GmbH & Co. KG**  
 Klingenbergstraße 26  
 D-32758 Detmold  
 Germany  
 Fon: +49 5231 14-0  
 Fax: +49 5231 14-292083  
 www.weidmueller.com

**Technical data****Dimensions and weights**

Width	17.24 mm	Width (inches)	0.679 inch
Height	23.3 mm	Height (inches)	0.917 inch
Depth	26.8 mm	Depth (inches)	1.055 inch
Net weight	10.09 g		

**System Parameters**

Product family	OMNIMATE Signal - series BL/SL 5.08	Type of connection	Field connection
Wire connection method	Clamping yoke connection	Pitch in mm (P)	5.08 mm
Pitch in inches (P)	0.2 inch	Conductor outlet direction	180°
Number of poles	3	L1 in mm	10.16 mm
L1 in inches	0.4 inch	Number of rows	1
Pin series quantity	1	Rated cross-section	2.5 mm <sup>2</sup>
Touch-safe protection acc. to DIN VDE 57 106	Safe from finger touch	Touch-safe protection acc. to DIN VDE 0470	IP 20
Volume resistance	≤ 5mΩ	Can be coded	Yes
Stripping length	7 mm	Tightening torque, min.	0.4 Nm
Tightening torque, max.	0.5 Nm	Clamping screw	M 2.5
Screwdriver blade	0.6 x 3.5	Screwdriver blade standard	DIN 5264
Plugging cycles	25	Plugging force/pole, max.	10 N
Pulling force/pole, max.	7.5 N		

**Material data**

Insulating material	PBT	Colour	orange
Colour chart (similar)	RAL 2000	Insulating material group	IIIa
Comparative Tracking Index (CTI)	≥ 200	Insulation strength	≥ 10 <sup>8</sup> Ω
UL 94 flammability rating	V-0	GWFI	960 °C
Contact material	Copper alloy	Contact surface	tinned
Layer structure of plug contact	4-8 μm Sn hot-dip tinned	Storage temperature, min.	-25 °C
Storage temperature, max.	50 °C	Max. relative humidity during storage	70 %
Operating temperature, min.	-50 °C	Operating temperature, max.	100 °C
Temperature range, installation, min.	-25 °C	Temperature range, installation, max.	100 °C

**Conductors suitable for connection**

Clamping range, min.	0.13 mm <sup>2</sup>
Clamping range, max.	3.31 mm <sup>2</sup>
Wire connection cross section AWG, min.	AWG 26
Wire connection cross section AWG, max.	AWG 12
Solid, min. H05(07) V-U	0.2 mm <sup>2</sup>
Solid, max. H05(07) V-U	2.5 mm <sup>2</sup>
Flexible, min. H05(07) V-K	0.2 mm <sup>2</sup>
Flexible, max. H05(07) V-K	2.5 mm <sup>2</sup>
w. plastic collar ferrule, DIN 46228 pt 4, min.	0.2 mm <sup>2</sup>
w. plastic collar ferrule, DIN 46228 pt 4, max.	1.5 mm <sup>2</sup>
w. wire end ferrule, DIN 46228 pt 1, min.	0.2 mm <sup>2</sup>
w. wire end ferrule, DIN 46228 pt 1, max.	1.5 mm <sup>2</sup>

Creation date May 3, 2020 4:04:45 PM CEST

**OMNIMATE Signal - series BL/SL 5.08**  
**BLDT 5.08/03/-B SN OR BX**

**Weidmüller Interface GmbH & Co. KG**  
 Klingenbergstraße 26  
 D-32758 Detmold  
 Germany  
 Fon: +49 5231 14-0  
 Fax: +49 5231 14-292083  
 www.weidmueller.com

**Technical data**

Plug gauge in accordance with EN 60999 a x b; ø 2.4 mm x 1.5 mm ; 2.4 mm

Clampable conductor	Cross-section for conductor connection	Type	fine-wired
		nominal	0.5 mm <sup>2</sup>
wire end ferrule		Stripping length	nominal 6 mm
		Recommended wire-end ferrule	<a href="#">H0.5/6</a>
Clampable conductor	Cross-section for conductor connection	Type	fine-wired
		nominal	0.75 mm <sup>2</sup>
wire end ferrule		Stripping length	nominal 6 mm
		Recommended wire-end ferrule	<a href="#">H0.75/6</a>
Clampable conductor	Cross-section for conductor connection	Type	fine-wired
		nominal	1 mm <sup>2</sup>
wire end ferrule		Stripping length	nominal 6 mm
		Recommended wire-end ferrule	<a href="#">H1.0/6</a>
Clampable conductor	Cross-section for conductor connection	Type	fine-wired
		nominal	1.5 mm <sup>2</sup>
wire end ferrule		Stripping length	nominal 7 mm
		Recommended wire-end ferrule	<a href="#">H1.5/7</a>

Reference text The outside diameter of the plastic collar should not be larger than the pitch (P), Length of ferrules is to be chosen depending on the product and the rated voltage.

Max. clamping range 3.31 mm<sup>2</sup>

**Rated data acc. to IEC**

tested acc. to standard	IEC 60664-1, IEC 61984	Rated current, min. number of poles (Tu=20°C)	14 A
Rated current, max. number of poles (Tu=20°C)	11.5 A	Rated current, min. number of poles (Tu=40°C)	12 A
Rated current, max. number of poles (Tu=40°C)	10 A	Rated voltage for surge voltage class / pollution degree II/2	400 V
Rated voltage for surge voltage class / pollution degree III/2	320 V	Rated voltage for surge voltage class / pollution degree III/3	250 V
Rated impulse voltage for surge voltage class/ pollution degree II/2	4 kV	Rated impulse voltage for surge voltage class/ pollution degree III/2	4 kV
Rated impulse voltage for surge voltage class/ contamination degree III/3	4 kV	Short-time withstand current resistance	3 x 1s with 120 A

**Rated data acc. to CSA**

Institute (CSA)		Certificate No. (CSA)	12400-365
Rated voltage (Use group B / CSA)	300 V	Rated voltage (Use group D / CSA)	300 V
Rated current (Use group B / CSA)	10 A	Rated current (Use group D / CSA)	10 A
Wire cross-section, AWG, min.	AWG 26	Wire cross-section, AWG, max.	AWG 12
Reference to approval values	Specifications are maximum values, details - see approval certificate.		

**Data sheet**

**OMNIMATE Signal - series BL/SL 5.08  
BLDT 5.08/03/-B SN OR BX**

**Weidmüller Interface GmbH & Co. KG**  
Klingenbergstraße 26  
D-32758 Detmold  
Germany  
Fon: +49 5231 14-0  
Fax: +49 5231 14-292083  
www.weidmueller.com

**Technical data**

**Rated data acc. to UL 1059**

Institute (UR)		Certificate No. (UR)	E60693
Rated voltage (Use group B / UL 1059)	300 V	Rated voltage (Use group D / UL 1059)	300 V
Rated current (Use group B / UL 1059)	10 A	Rated current (Use group D / UL 1059)	10 A
Wire cross-section, AWG, min.	AWG 26	Wire cross-section, AWG, max.	AWG 12
Reference to approval values	Specifications are maximum values, details - see approval certificate.		

**Packing**

Packaging	Box	VPE length	80 mm
VPE width	90 mm	VPE height	200 mm

**Classifications**

ETIM 6.0	EC002638	ETIM 7.0	EC002638
eClass 9.0	27-44-03-09	eClass 9.1	27-44-03-09
eClass 10.0	27-44-03-09	UNSPSC	30-21-18-10

**Notes**

Notes	<ul style="list-style-type: none"> <li>• Additional colours on request</li> <li>• Gold-plated contact surfaces on request</li> <li>• Rated current related to rated cross-section &amp; min. No. of poles.</li> <li>• Wire end ferrule without plastic collar to DIN 46228/1</li> <li>• Wire end ferrule with plastic collar to DIN 46228/4</li> <li>• P on drawing = pitch</li> <li>• Rated data refer only to the component itself. Clearance and creepage distances to other components are to be designed in accordance with the relevant application standards.</li> </ul>
-------	---------------------------------------------------------------------------------------------------------------------------------------------------------------------------------------------------------------------------------------------------------------------------------------------------------------------------------------------------------------------------------------------------------------------------------------------------------------------------------------------------------------------------------------------------------------------------------

IPC conformity	Conformity: The products are developed, manufactured and delivered according international recognized standards and norms and comply with the assured properties in the data sheet resp. fulfill decorative properties in accordance with IPC-A-610 "Class 2". Further claims on the products can be evaluated on request.
----------------	----------------------------------------------------------------------------------------------------------------------------------------------------------------------------------------------------------------------------------------------------------------------------------------------------------------------------

**Approvals**

Approvals	
ROHS	Conform

**Data sheet****OMNIMATE Signal - series BL/SL 5.08  
BLDT 5.08/03/-B SN OR BX**

**Weidmüller Interface GmbH & Co. KG**  
Klingenbergstraße 26  
D-32758 Detmold  
Germany  
Fon: +49 5231 14-0  
Fax: +49 5231 14-292083  
www.weidmueller.com

**Technical data****Downloads**

Approval/Certificate/Document of Conformity	<a href="#">Declaration of the Manufacturer</a>
Brochure/Catalogue	<a href="#">FL DRIVES EN</a> <a href="#">MB DEVICE MANUF. EN</a> <a href="#">FL DRIVES DE</a> <a href="#">CAT 2 PORTFOLIOGUIDE EN</a> <a href="#">FL BUILDING SAFETY EN</a> <a href="#">FL APPL LED LIGHTING EN</a> <a href="#">FL INDUSTR.CONTROLS EN</a> <a href="#">FL MACHINE SAFETY EN</a> <a href="#">FL HEATING ELECTR EN</a> <a href="#">FL APPL INVERTER EN</a> <a href="#">FL BASE STATION EN</a> <a href="#">FL ELEVATOR EN</a> <a href="#">FL POWER SUPPLY EN</a> <a href="#">FL 72H SAMPLE SER EN</a> <a href="#">PO OMNIMATE EN</a>
Engineering Data	<a href="#">WSCAD</a>
Engineering Data	<a href="#">STEP</a>

**Data sheet**

**OMNIMATE Signal - series BL/SL 5.08  
BLDT 5.08/03/-B SN OR BX**

**Weidmüller Interface GmbH & Co. KG**  
 Klingenbergstraße 26  
 D-32758 Detmold  
 Germany  
 Fon: +49 5231 14-0  
 Fax: +49 5231 14-292083  
 www.weidmueller.com

**Drawings**

**Dimensional drawing**

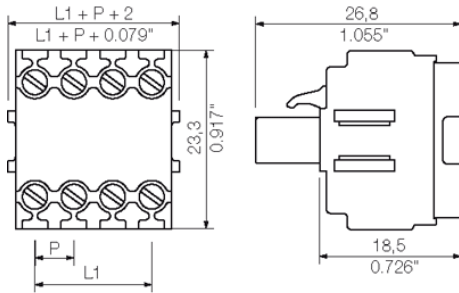

**Graph**

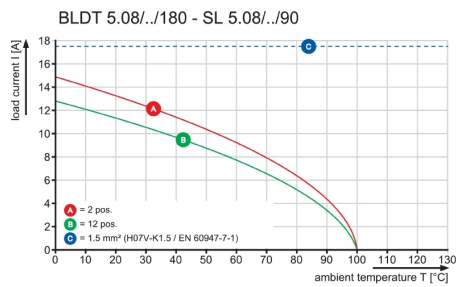

**OMNIMATE Signal - series BL/SL 5.08  
BLDT 5.08/03/-B SN OR BX**

**Weidmüller Interface GmbH & Co. KG**  
Klingenbergstraße 26  
D-32758 Detmold  
Germany  
Fon: +49 5231 14-0  
Fax: +49 5231 14-292083  
www.weidmueller.com

**Mating connector (fully pluggable)**
**SL-SMT 5.08/180 Tape**

High-temperature-resistant, straight, open pin header. Packed in box or tape. On tape and with 1.5 mm solder pin, optimised for automatic assembly. 3.2 mm solder pin suitable for reflow and wave soldering. The pin headers provide space for labelling and can be coded. HC = High Current.

**General ordering data**

Type	SL-SMT 5.08HC/03/180 1. ...	Version	Product data	Packaging
Order No.	<a href="#">1821110000</a>	PCB plug-in connector, male header, open side, THT/THR solder connection, 5.08 mm, Number of poles: 3, 180°, Solder pin length (l): 1.5 mm, tinned, black, Tape	IEC: 400 V / 27.5 A UL: 300 V / 18.5 A	Tape
GTIN (EAN)	4032248319756			
Qty.	250 pc(s).			

**SL-SMT 5.08/180G Box**

High-temperature-resistant pin header, packed in box or tape. On tape, with 1.5 mm solder pin, optimised for automatic assembly. 3.2 mm solder pin suitable for reflow and wave soldering. The pin headers provide space for labelling and can be coded. HC = High Current.

**General ordering data**

Type	SL-SMT 5.08HC/03/180G 3 ...	Version	Product data	Packaging
Order No.	<a href="#">1838220000</a>	PCB plug-in connector, male header, closed side, THT/THR solder connection, 5.08 mm, Number of poles: 3, 180°, Solder pin length (l): 3.2 mm, tinned, black, Box	IEC: 400 V / 27.5 A UL: 300 V / 18.5 A	Box
GTIN (EAN)	4032248348282			
Qty.	100 pc(s).			
Type	SL-SMT 5.08HC/03/180G 1 ...	Version	Product data	Packaging
Order No.	<a href="#">1775932001</a>	PCB plug-in connector, male header, closed side, THT/THR solder connection, 5.08 mm, Number of poles: 3, 180°, Solder pin length (l): 1.5 mm, tinned, black, Box	IEC: 400 V / 27.5 A UL: 300 V / 18.5 A	Box
GTIN (EAN)	4032248158928			
Qty.	100 pc(s).			

**OMNIMATE Signal - series BL/SL 5.08  
BLDT 5.08/03/-B SN OR BX**

**Weidmüller Interface GmbH & Co. KG**  
Klingenbergstraße 26  
D-32758 Detmold  
Germany  
Fon: +49 5231 14-0  
Fax: +49 5231 14-292083  
www.weidmueller.com

**Mating connector (fully pluggable)**
**SL 5.08/135**

Male connectors with 135° outlet direction. The solder pin length is optimised for wave flow soldering. The pin headers provide space for labelling and can be coded.

**General ordering data**

Type	SL 5.08/03/135 3.2SN OR ...	Version	Product data	Packaging
Order No.	<a href="#">1603070000</a>	PCB plug-in connector, male header, open side, THT solder	IEC: 400 V / 17 A	Box
GTIN (EAN)	4008190089412	connection, 5.08 mm, Number of poles: 3, 135°, Solder pin length (l):	UL: 300 V / 15 A	
Qty.	100 pc(s).	3.2 mm, tinned, orange, Box		

**SL-SMT 5.08/270GH Box**

High-temperature-resistant, straight, open pin header. Packed in box or tape. On tape and with 1.5 mm solder pin, optimised for automatic assembly. 3.2 mm solder pin suitable for reflow and wave soldering. The pin headers provide space for labelling and can be coded. HC = High Current.

**General ordering data**

Type	SL-SMT 5.08HC/03/270GH ...	Version	Product data	Packaging
Order No.	<a href="#">1877380000</a>	PCB plug-in connector, male header, closed side, THT/THR solder	IEC: 400 V / 27.5 A	Box
GTIN (EAN)	4032248468010	connection, 5.08 mm, Number of poles: 3, 270°, Solder pin length (l):	UL: 300 V / 18.5 A	
Qty.	100 pc(s).	3.2 mm, tinned, black, Box		
Type	SL-SMT 5.08HC/03/270GH ...	Version	Product data	Packaging
Order No.	<a href="#">1877010000</a>	PCB plug-in connector, male header, closed side, THT/THR solder	IEC: 400 V / 27.5 A	Box
GTIN (EAN)	4032248467525	connection, 5.08 mm, Number of poles: 3, 270°, Solder pin length (l):	UL: 300 V / 18.5 A	
Qty.	100 pc(s).	1.5 mm, tinned, black, Box		



**OMNIMATE Signal - series BL/SL 5.08  
BLDT 5.08/03/-B SN OR BX**

**Weidmüller Interface GmbH & Co. KG**  
Klingenbergstraße 26  
D-32758 Detmold  
Germany  
Fon: +49 5231 14-0  
Fax: +49 5231 14-292083  
www.weidmueller.com

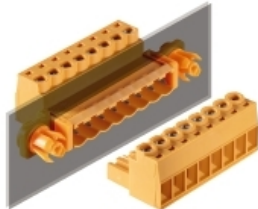
**Mating connector (fully pluggable)**
**SLS 5.08/180DF SN**

Male plugs with clamping-yoke screw wire-connect system. The male plugs provide space for labelling and can be coded.

**General ordering data**

Type	SLS 5.08/03/180DF SN OR ...	Version	Product data	Packaging
Order No.	<a href="#">1353480000</a>	PCB plug-in connector, male plug, 5.08 mm, Number of poles: 3,	IEC: 400 V / 21.5 A / 0.2 - 2.5 mm <sup>2</sup>	Box
GTIN (EAN)	4050118156164	180°, Clamping yoke connection, Clamping range, max. : 3.31 mm <sup>2</sup> ,	UL: 300 V / 14 A / AWG 26 - AWG 12	
Qty.	42 pc(s).	Box		

**SL 5.08HC/180B**

Pin headers in glass-fibre-reinforced plastic with straight wire outlet; optimised for wave soldering. The flange variant (F) can be screwed onto the respective counter piece or the circuit board. There is no need for an extra screw to connect the circuit board when the solder flange (LF) version is used. This also protects the solder points from mechanical strain. All pin headers can be manually coded or ordered pre-coded. HC = High Current.

**General ordering data**

Type	SL 5.08HC/03/180B 3.2SN ...	Version	Product data	Packaging
Order No.	<a href="#">1147330000</a>	PCB plug-in connector, male header, Dovetails for fixing blocks, THT	IEC: 400 V / 24 A	Box
GTIN (EAN)	4032248933099	solder connection, 5.08 mm, Number of poles: 3, 180°, Solder pin	UL: 300 V / 18.5 A	
Qty.	100 pc(s).	length (l): 3.2 mm, tinned, orange, Box		
Type	SL 5.08HC/03/180B 3.2SN ...	Version	Product data	Packaging
Order No.	<a href="#">1149430000</a>	PCB plug-in connector, male header, Dovetails for fixing blocks, THT	IEC: 400 V / 24 A	Box
GTIN (EAN)	4032248935123	solder connection, 5.08 mm, Number of poles: 3, 180°, Solder pin	UL: 300 V / 18.5 A	
Qty.	100 pc(s).	length (l): 3.2 mm, tinned, black, Box		

**OMNIMATE Signal - series BL/SL 5.08  
BLDT 5.08/03/-B SN OR BX**

**Weidmüller Interface GmbH & Co. KG**  
Klingenbergstraße 26  
D-32758 Detmold  
Germany  
Fon: +49 5231 14-0  
Fax: +49 5231 14-292083  
www.weidmueller.com

**Mating connector (fully pluggable)**
**SLDV 5.08/90B**

Pin headers with solder pin length optimised for wave flow soldering. The male connectors provide space for labelling and can be coded. HC = High Current.

**General ordering data**

Type	SLD 5.08V/06/90B 3.2 SN ...	Version	Product data	Packaging
Order No.	<a href="#">1726290000</a>	PCB plug-in connector, male header, Dovetails for fixing blocks, THT	IEC: 400 V / 17 A	Box
GTIN (EAN)	4032248061266	solder connection, 5.08 mm, Number of poles: 6, 90°, Solder pin	UL: 300 V / 10 A	
Qty.	50 pc(s).	length (l): 3.2 mm, tinned, orange, Box		

**SL 5.08/180B**

Male connectors with straight outlet direction. The solder pin length is optimised for wave flow soldering. The pin headers provide space for labelling and can be coded.

**General ordering data**

Type	SL 5.08/03/180B 3.2SN O ...	Version	Product data	Packaging
Order No.	<a href="#">1519660000</a>	PCB plug-in connector, male header, Dovetails for fixing blocks, THT	IEC: 400 V / 18 A	Box
GTIN (EAN)	4008190110024	solder connection, 5.08 mm, Number of poles: 3, 180°, Solder pin	UL: 300 V / 15 A	
Qty.	108 pc(s).	length (l): 3.2 mm, tinned, orange, Box		

## OMNIMATE Signal - series BL/SL 5.08 BLDT 5.08/03/-B SN OR BX

**Weidmüller Interface GmbH & Co. KG**  
 Klingenbergstraße 26  
 D-32758 Detmold  
 Germany  
 Fon: +49 5231 14-0  
 Fax: +49 5231 14-292083  
 www.weidmueller.com

### Mating connector (fully pluggable)

#### SL-SMT 5.08/180G Tape



High-temperature-resistant pin header, packed in box or tape. On tape, with 1.5 mm solder pin, optimised for automatic assembly. 3.2 mm solder pin suitable for reflow and wave soldering. The pin headers provide space for labelling and can be coded. HC = High Current.

#### General ordering data

Type	SL-SMT 5.08HC/03/180G 1 ...	Version	Product data	Packaging
Order No.	<a href="#">1775934001</a>	PCB plug-in connector, male header, closed side, THT/THR solder connection, 5.08 mm, Number of poles: 3, 180°, Solder pin length (l): 1.5 mm, tinned, black, Tape	IEC: 400 V / 27.5 A UL: 300 V / 18.5 A	Tape
GTIN (EAN)	4032248160112			
Qty.	250 pc(s).			

#### SL-SMT 5.08HC/90 Box



High-temperature-resistant, 90° angled, open male header. Packed in box or tape. On tape, with 1.5 mm solder pin, optimised for automatic assembly. 3.2 mm solder pin suitable for reflow and wave soldering. The pin headers provide space for labelling and can be coded. HC = High Current.

#### General ordering data

Type	SL-SMT 5.08HC/03/90 3.2 ...	Version	Product data	Packaging
Order No.	<a href="#">1779960000</a>	PCB plug-in connector, male header, open side, THT/THR solder connection, 5.08 mm, Number of poles: 3, 90°, Solder pin length (l): 3.2 mm, tinned, black, Box	IEC: 400 V / 27.5 A UL: 300 V / 18.5 A	Box
GTIN (EAN)	4032248165285			
Qty.	100 pc(s).			
Type	SL-SMT 5.08HC/03/90 1.5 ...	Version	Product data	Packaging
Order No.	<a href="#">1774772001</a>	PCB plug-in connector, male header, open side, THT/THR solder connection, 5.08 mm, Number of poles: 3, 90°, Solder pin length (l): 1.5 mm, tinned, black, Box	IEC: 400 V / 27.5 A UL: 300 V / 18.5 A	Box
GTIN (EAN)	4032248155705			
Qty.	100 pc(s).			

**OMNIMATE Signal - series BL/SL 5.08  
BLDT 5.08/03/-B SN OR BX**

**Weidmüller Interface GmbH & Co. KG**  
Klingenbergstraße 26  
D-32758 Detmold  
Germany  
Fon: +49 5231 14-0  
Fax: +49 5231 14-292083  
www.weidmueller.com

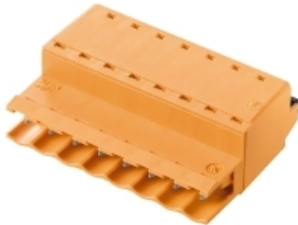
**Mating connector (fully pluggable)**
**SLF 5.08/180 SN**

Male plug with PUSH IN wire connection and straight outlet direction, when used with BLF 5.08HC as wire-to-wire application for panel feed-through. The male plugs provide space for labelling and can be coded.

**General ordering data**

Type	SLF 5.08/03/180 SN OR BX	Version	Product data	Packaging
Order No.	<a href="#">1335340000</a>	PCB plug-in connector, male plug, 5.08 mm, Number of poles: 3,	IEC: 400 V / 25.9 A / 0.2 - 2.5 mm <sup>2</sup>	Box
GTIN (EAN)	4050118138566	180°, PUSH IN, Spring connection, Clamping range, max.: 3.31 mm <sup>2</sup> , UL: 300 V / 14 A / AWG 26 - AWG 12		
Qty.	120 pc(s).	Box		
Type	SLF 5.08/03/180 SN BK BX	Version	Product data	Packaging
Order No.	<a href="#">1335570000</a>	PCB plug-in connector, male plug, 5.08 mm, Number of poles: 3,	IEC: 400 V / 25.9 A / 0.2 - 2.5 mm <sup>2</sup>	Box
GTIN (EAN)	4050118139105	180°, PUSH IN, Spring connection, Clamping range, max.: 3.31 mm <sup>2</sup> , UL: 300 V / 14 A / AWG 26 - AWG 12		
Qty.	120 pc(s).	Box		

**SL-SMT 5.08HC/90G Box**

High-temperature-resistant pin header, packed in box or tape. On tape, with 1.5 mm solder pin, optimised for automatic assembly. 3.2 mm solder pin suitable for reflow and wave soldering. The pin headers provide space for labelling and can be coded. HC = High Current.

**General ordering data**

Type	SL-SMT 5.08HC/03/90G 3. ...	Version	Product data	Packaging
Order No.	<a href="#">1780190000</a>	PCB plug-in connector, male header, closed side, THT/THR solder connection, 5.08 mm, Number of poles: 3, 90°, Solder pin length (l):	IEC: 400 V / 27.5 A UL: 300 V / 18.5 A	Box
GTIN (EAN)	4032248165513	3.2 mm, tinned, black, Box		
Qty.	100 pc(s).			
Type	SL-SMT 5.08HC/03/90G 1. ...	Version	Product data	Packaging
Order No.	<a href="#">1775012001</a>	PCB plug-in connector, male header, closed side, THT/THR solder connection, 5.08 mm, Number of poles: 3, 90°, Solder pin length (l):	IEC: 400 V / 27.5 A UL: 300 V / 18.5 A	Box
GTIN (EAN)	4032248156030	1.5 mm, tinned, black, Box		
Qty.	100 pc(s).			

**OMNIMATE Signal - series BL/SL 5.08  
BLDT 5.08/03/-B SN OR BX**

**Weidmüller Interface GmbH & Co. KG**  
Klingenbergstraße 26  
D-32758 Detmold  
Germany  
Fon: +49 5231 14-0  
Fax: +49 5231 14-292083  
www.weidmuller.com

**Mating connector (fully pluggable)**
**SL 5.08HC/90G**

Pin headers made from glass-fibre-reinforced plastic with 90° wire outlet; optimised for wave soldering. The flange variant (F) can be screwed onto the respective counter piece or the circuit board. There is no need for an extra screw to connect the circuit board when the solder flange (LF) version is used. This also protects the solder points from mechanical strain. All pin headers can be manually coded or ordered pre-coded. HC = High Current.

**General ordering data**

Type	SL 5.08HC/03/90G 3.2SN ...	Version	Product data	Packaging
Order No.	<a href="#">1155330000</a>	PCB plug-in connector, male header, closed side, THT solder connection, 5.08 mm, Number of poles: 3, 90°, Solder pin length (l): 3.2 mm, tinned, black, Box	IEC: 400 V / 24 A UL: 300 V / 18.5 A	Box
GTIN (EAN)	4050118050578			
Qty.	100 pc(s).			
Type	SL 5.08HC/03/90G 3.2SN ...	Version	Product data	Packaging
Order No.	<a href="#">1147310000</a>	PCB plug-in connector, male header, closed side, THT solder connection, 5.08 mm, Number of poles: 3, 90°, Solder pin length (l): 3.2 mm, tinned, orange, Box	IEC: 400 V / 24 A UL: 300 V / 18.5 A	Box
GTIN (EAN)	4050118051261			
Qty.	100 pc(s).			

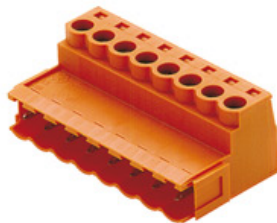
**SLS 5.08/180B**

Male plugs with clamping-yoke screw wire-connect system. The male plugs provide space for labelling and can be coded.

**General ordering data**

Type	SLS 5.08/03/180B SN OR ...	Version	Product data	Packaging
Order No.	<a href="#">1627250000</a>	PCB plug-in connector, male plug, 5.08 mm, Number of poles: 3, 180°, Clamping yoke connection, Clamping range, max. : 3.31 mm², UL: 300 V / 14 A / AWG 26 - AWG 12	IEC: 400 V / 21.5 A / 0.2 - 2.5 mm² UL: 300 V / 14 A / AWG 26 - AWG 12	Box
GTIN (EAN)	4008190199760			
Qty.	108 pc(s).			

**OMNIMATE Signal - series BL/SL 5.08  
BLDT 5.08/03/-B SN OR BX**

**Weidmüller Interface GmbH & Co. KG**  
Klingenbergstraße 26  
D-32758 Detmold  
Germany  
Fon: +49 5231 14-0  
Fax: +49 5231 14-292083  
www.weidmueller.com

**Mating connector (fully pluggable)**
**SL-SMT 5.08/270GL Box**

High-temperature-resistant, straight, open pin header. Packed in box or tape. On tape and with 1.5 mm solder pin, optimised for automatic assembly. 3.2 mm solder pin suitable for reflow and wave soldering. The pin headers provide space for labelling and can be coded. HC = High Current.

**General ordering data**

Type	SL-SMT 5.08HC/03/270GL ...	Version	Product data	Packaging
Order No.	<a href="#">1877490000</a>	PCB plug-in connector, male header, closed side, THT/THR solder connection, 5.08 mm, Number of poles: 3, 270°, Solder pin length (l): 3.2 mm, tinned, black, Box	IEC: 400 V / 27.5 A UL: 300 V / 18.5 A	Box
GTIN (EAN)	4032248468119			
Qty.	100 pc(s).			
Type	SL-SMT 5.08/03/270GL 1. ...	Version	Product data	Packaging
Order No.	<a href="#">1877130000</a>	PCB plug-in connector, male header, closed side, THT/THR solder connection, 5.08 mm, Number of poles: 3, 270°, Solder pin length (l): 1.5 mm, tinned, black, Box	IEC: 400 V / 27.5 A UL: 300 V / 18.5 A	Box
GTIN (EAN)	4032248467587			
Qty.	100 pc(s).			

**SLDV 5.08/90**

Pin headers with solder pin length optimised for wave flow soldering. The male connectors provide space for labelling and can be coded. HC = High Current.

**General ordering data**

Type	SLD 5.08V/06/90 3.2 SN ...	Version	Product data	Packaging
Order No.	<a href="#">1725180000</a>	PCB plug-in connector, male header, open side, THT solder connection, 5.08 mm, Number of poles: 6, 90°, Solder pin length (l): 3.2 mm, tinned, orange, Box	IEC: 400 V / 17 A UL: 300 V / 10 A	Box
GTIN (EAN)	4032248060580			
Qty.	50 pc(s).			

**OMNIMATE Signal - series BL/SL 5.08  
BLDT 5.08/03/-B SN OR BX**

**Weidmüller Interface GmbH & Co. KG**  
Klingenbergstraße 26  
D-32758 Detmold  
Germany  
Fon: +49 5231 14-0  
Fax: +49 5231 14-292083  
www.weidmuller.com

**Mating connector (fully pluggable)**
**SL 5.08/90B**

Male connectors with 90° outlet direction. The solder pin length is optimised for wave flow soldering. The pin headers provide space for labelling and can be coded.

**General ordering data**

Type	SL 5.08/03/90B 3.2SN OR ...	Version	Product data	Packaging
Order No.	<a href="#">1510460000</a>	PCB plug-in connector, male header, Dovetails for fixing blocks, THT	IEC: 400 V / 18 A	Box
GTIN (EAN)	4008190054892	solder connection, 5.08 mm, Number of poles: 3, 90°, Solder pin	UL: 300 V / 15 A	
Qty.	100 pc(s).	length (l): 3.2 mm, tinned, orange, Box		

**SL-SMT 5.08/270GL Tape**

High-temperature-resistant, straight, open pin header. Packed in box or tape. On tape and with 1.5 mm solder pin, optimised for automatic assembly. 3.2 mm solder pin suitable for reflow and wave soldering. The pin headers provide space for labelling and can be coded. HC = High Current.

**General ordering data**

Type	SL-SMT 5.08HC/03/270GL ...	Version	Product data	Packaging
Order No.	<a href="#">1877750000</a>	PCB plug-in connector, male header, closed side, THT/THR solder	IEC: 400 V / 27.5 A	Tape
GTIN (EAN)	4032248467907	connection, 5.08 mm, Number of poles: 3, 270°, Solder pin length (l):	UL: 300 V / 18.5 A	
Qty.	350 pc(s).	1.5 mm, tinned, black, Tape		
Type	SL-SMT 5.08/03/270GL 3. ...	Version	Product data	Packaging
Order No.	<a href="#">1877890000</a>	PCB plug-in connector, male header, closed side, THT/THR solder	IEC: 400 V / 27.5 A	Tape
GTIN (EAN)	4032248468560	connection, 5.08 mm, Number of poles: 3, 270°, Solder pin length (l):	UL: 300 V / 18.5 A	
Qty.	350 pc(s).	3.2 mm, tinned, black, Tape		

**OMNIMATE Signal - series BL/SL 5.08  
BLDT 5.08/03/-B SN OR BX**

**Weidmüller Interface GmbH & Co. KG**  
Klingenbergstraße 26  
D-32758 Detmold  
Germany  
Fon: +49 5231 14-0  
Fax: +49 5231 14-292083  
www.weidmueller.com

**Mating connector (fully pluggable)**
**SL 5.08/90**

Male connectors with 90° outlet direction. The solder pin length is optimised for wave flow soldering. The pin headers provide space for labelling and can be coded.

**General ordering data**

Type	SL 5.08/03/90 3.2SN OR ...	Version	Product data	Packaging
Order No.	<a href="#">1508160000</a>	PCB plug-in connector, male header, open side, THT solder	IEC: 400 V / 18 A	Box
GTIN (EAN)	4008190028879	connection, 5.08 mm, Number of poles: 3, 90°, Solder pin length (l):	UL: 300 V / 15 A	
Qty.	100 pc(s).	3.2 mm, tinned, orange, Box		

**SL 5.08HC/180**

Pin headers in glass-fibre-reinforced plastic with straight wire outlet; optimised for wave soldering. The flange variant (F) can be screwed onto the respective counter piece or the circuit board. There is no need for an extra screw to connect the circuit board when the solder flange (LF) version is used. This also protects the solder points from mechanical strain. All pin headers can be manually coded or ordered pre-coded. HC = High Current.

**General ordering data**

Type	SL 5.08HC/03/180 3.2SN ...	Version	Product data	Packaging
Order No.	<a href="#">1148110000</a>	PCB plug-in connector, male header, open side, THT solder	IEC: 400 V / 24 A	Box
GTIN (EAN)	4032248934225	connection, 5.08 mm, Number of poles: 3, 180°, Solder pin length (l):	UL: 300 V / 18.5 A	
Qty.	100 pc(s).	3.2 mm, tinned, black, Box		
Type	SL 5.08HC/03/180 3.2SN ...	Version	Product data	Packaging
Order No.	<a href="#">1146340000</a>	PCB plug-in connector, male header, open side, THT solder	IEC: 400 V / 24 A	Box
GTIN (EAN)	4032248932559	connection, 5.08 mm, Number of poles: 3, 180°, Solder pin length (l):	UL: 300 V / 18.5 A	
Qty.	100 pc(s).	3.2 mm, tinned, orange, Box		



**OMNIMATE Signal - series BL/SL 5.08  
BLDT 5.08/03/-B SN OR BX**

**Weidmüller Interface GmbH & Co. KG**  
Klingenbergstraße 26  
D-32758 Detmold  
Germany  
Fon: +49 5231 14-0  
Fax: +49 5231 14-292083  
www.weidmueller.com

**Mating connector (fully pluggable)**
**SLDV 5.08/180B**

Pin headers with solder pin length optimised for wave flow soldering. The male connectors provide space for labelling and can be coded. HC = High Current.

**General ordering data**

Type	SLD 5.08V/06/180B 3.2SN ...	Version	Product data	Packaging
Order No.	<a href="#">1726750000</a>	PCB plug-in connector, male header, Dovetails for fixing blocks, THT	IEC: 400 V / 14 A	Box
GTIN (EAN)	4032248062638	solder connection, 5.08 mm, Number of poles: 6, 180°, Solder pin	UL: 300 V / 10 A	
Qty.	50 pc(s).	length (l): 3.2 mm, tinned, orange, Box		

**SLT 5.08B**

Male plugs with screw TOP wire connection. The male plug provides space for labelling and can be coded.

**General ordering data**

Type	SLT 5.08/03/180B SN OR ...	Version	Product data	Packaging
Order No.	<a href="#">1611720000</a>	PCB plug-in connector, male plug, 5.08 mm, Number of poles: 3,	IEC: 400 V / 16 A / 0.2 - 2.5 mm <sup>2</sup>	Box
GTIN (EAN)	4008190192600	180°, TOP connection, Clamping range, max. : 2.5 mm <sup>2</sup> , Box	UL: 300 V / 15 A / AWG 26 - AWG 14	
Qty.	100 pc(s).			

**OMNIMATE Signal - series BL/SL 5.08  
BLDT 5.08/03/-B SN OR BX**

**Weidmüller Interface GmbH & Co. KG**  
Klingenbergstraße 26  
D-32758 Detmold  
Germany  
Fon: +49 5231 14-0  
Fax: +49 5231 14-292083  
www.weidmuller.com

**Mating connector (fully pluggable)**
**SL 5.08HC/90B**

Pin headers made from glass-fibre-reinforced plastic with 90° wire outlet; optimised for wave soldering. The flange variant (F) can be screwed onto the respective counter piece or the circuit board. There is no need for an extra screw to connect the circuit board when the solder flange (LF) version is used. This also protects the solder points from mechanical strain. All pin headers can be manually coded or ordered pre-coded. HC = High Current.

**General ordering data**

Type	SL 5.08HC/03/90B 3.2SN ...	Version	Product data	Packaging
Order No.	<a href="#">1155590000</a>	PCB plug-in connector, male header, Dovetails for fixing blocks, THT	IEC: 400 V / 24 A	Box
GTIN (EAN)	4050118050349	solder connection, 5.08 mm, Number of poles: 3, 90°, Solder pin	UL: 300 V / 18.5 A	
Qty.	100 pc(s).	length (l): 3.2 mm, tinned, black, Box		
Type	SL 5.08HC/03/90B 3.2SN ...	Version	Product data	Packaging
Order No.	<a href="#">1148070000</a>	PCB plug-in connector, male header, Dovetails for fixing blocks, THT	IEC: 400 V / 24 A	Box
GTIN (EAN)	4050118051032	solder connection, 5.08 mm, Number of poles: 3, 90°, Solder pin	UL: 300 V / 18.5 A	
Qty.	100 pc(s).	length (l): 3.2 mm, tinned, orange, Box		

**SLF 5.08/180B SN**

Male plug with PUSH IN wire connection and straight outlet direction, when used with BLF 5.08HC as wire-to-wire application for panel feed-through. The male plugs provide space for labelling and can be coded.

**General ordering data**

Type	SLF 5.08/03/180B SN BK ...	Version	Product data	Packaging
Order No.	<a href="#">1335790000</a>	PCB plug-in connector, male plug, 5.08 mm, Number of poles: 3,	IEC: 400 V / 25.9 A / 0.2 - 2.5 mm <sup>2</sup>	Box
GTIN (EAN)	4050118140163	180°, PUSH IN, Spring connection, Clamping range, max.: 3.31 mm <sup>2</sup> ,	UL: 300 V / 14 A / AWG 26 - AWG 12	
Qty.	108 pc(s).	Box		
Type	SLF 5.08/03/180B SN OR ...	Version	Product data	Packaging
Order No.	<a href="#">1335450000</a>	PCB plug-in connector, male plug, 5.08 mm, Number of poles: 3,	IEC: 400 V / 25.9 A / 0.2 - 2.5 mm <sup>2</sup>	Box
GTIN (EAN)	4050118138658	180°, PUSH IN, Spring connection, Clamping range, max.: 3.31 mm <sup>2</sup> ,	UL: 300 V / 14 A / AWG 26 - AWG 12	
Qty.	108 pc(s).	Box		

**OMNIMATE Signal - series BL/SL 5.08  
BLDT 5.08/03/-B SN OR BX**

**Weidmüller Interface GmbH & Co. KG**  
Klingenbergstraße 26  
D-32758 Detmold  
Germany  
Fon: +49 5231 14-0  
Fax: +49 5231 14-292083  
www.weidmueller.com

**Mating connector (fully pluggable)**
**SL 5.08HC/180G**

Pin headers in glass-fibre-reinforced plastic with straight wire outlet; optimised for wave soldering. The flange variant (F) can be screwed onto the respective counter piece or the circuit board. There is no need for an extra screw to connect the circuit board when the solder flange (LF) version is used. This also protects the solder points from mechanical strain. All pin headers can be manually coded or ordered pre-coded. HC = High Current.

**General ordering data**

Type	SL 5.08HC/03/180G 3.2SN ...	Version	Product data	Packaging
Order No.	<a href="#">1146750000</a>	PCB plug-in connector, male header, closed side, THT solder	IEC: 400 V / 24 A	Box
GTIN (EAN)	4032248108671	connection, 5.08 mm, Number of poles: 3, 180°, Solder pin length (l):	UL: 300 V / 18.5 A	
Qty.	100 pc(s).	3.2 mm, tinned, orange, Box		
Type	SL 5.08HC/03/180G 3.2SN ...	Version	Product data	Packaging
Order No.	<a href="#">1148670000</a>	PCB plug-in connector, male header, closed side, THT solder	IEC: 400 V / 24 A	Box
GTIN (EAN)	4032248933945	connection, 5.08 mm, Number of poles: 3, 180°, Solder pin length (l):	UL: 300 V / 18.5 A	
Qty.	100 pc(s).	3.2 mm, tinned, black, Box		

**SL 5.08HC/90**



Pin headers made from glass-fibre-reinforced plastic with 90° wire outlet; optimised for wave soldering. The flange variant (F) can be screwed onto the respective counter piece or the circuit board. There is no need for an extra screw to connect the circuit board when the solder flange (LF) version is used. This also protects the solder points from mechanical strain. All pin headers can be manually coded or ordered pre-coded. HC = High Current.

**General ordering data**

Type	SL 5.08HC/03/90 3.2SN O ...	Version	Product data	Packaging
Order No.	<a href="#">1146740000</a>	PCB plug-in connector, male header, open side, THT solder	IEC: 400 V / 24 A	Box
GTIN (EAN)	4050118051490	connection, 5.08 mm, Number of poles: 3, 90°, Solder pin length (l):	UL: 300 V / 18.5 A	
Qty.	100 pc(s).	3.2 mm, tinned, orange, Box		
Type	SL 5.08HC/03/90 3.2SN B ...	Version	Product data	Packaging
Order No.	<a href="#">1155040000</a>	PCB plug-in connector, male header, open side, THT solder	IEC: 400 V / 24 A	Box
GTIN (EAN)	4050118050806	connection, 5.08 mm, Number of poles: 3, 90°, Solder pin length (l):	UL: 300 V / 18.5 A	
Qty.	100 pc(s).	3.2 mm, tinned, black, Box		

**OMNIMATE Signal - series BL/SL 5.08  
BLDT 5.08/03/-B SN OR BX**

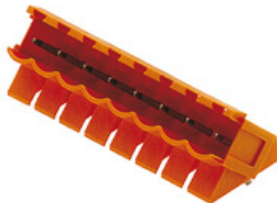
**Weidmüller Interface GmbH & Co. KG**  
 Klingenbergstraße 26  
 D-32758 Detmold  
 Germany  
 Fon: +49 5231 14-0  
 Fax: +49 5231 14-292083  
 www.weidmueller.com

**Mating connector (fully pluggable)**
**SL 5.08/135B**

Male connectors with 135° outlet direction. The solder pin length is optimised for wave flow soldering. The pin headers provide space for labelling and can be coded.

**General ordering data**

Type	SL 5.08/03/135B 3.2SN O ...	Version	Product data	Packaging
Order No.	<a href="#">1605540000</a>	PCB plug-in connector, male header, Dovetails for fixing blocks, THT	IEC: 400 V / 17 A	Box
GTIN (EAN)	4008190097059	solder connection, 5.08 mm, Number of poles: 3, 135°, Solder pin	UL: 300 V / 15 A	
Qty.	100 pc(s).	length (l): 3.2 mm, tinned, orange, Box		

**SLDV 5.08/180**

Pin headers with solder pin length optimised for wave flow soldering. The male connectors provide space for labelling and can be coded. HC = High Current.

**General ordering data**

Type	SLD 5.08V/06/180 3.2SN ...	Version	Product data	Packaging
Order No.	<a href="#">1725660000</a>	PCB plug-in connector, male header, open side, THT solder	IEC: 400 V / 14 A	Box
GTIN (EAN)	4032248061952	connection, 5.08 mm, Number of poles: 6, 180°, Solder pin length (l):	UL: 300 V / 10 A	
Qty.	50 pc(s).	3.2 mm, tinned, orange, Box		

**OMNIMATE Signal - series BL/SL 5.08  
BLDT 5.08/03/-B SN OR BX**

**Weidmüller Interface GmbH & Co. KG**  
Klingenbergstraße 26  
D-32758 Detmold  
Germany  
Fon: +49 5231 14-0  
Fax: +49 5231 14-292083  
www.weidmueller.com

**Mating connector (fully pluggable)**
**SL-SMT 5.08/270GH Tape**

High-temperature-resistant, straight, open pin header. Packed in box or tape. On tape and with 1.5 mm solder pin, optimised for automatic assembly. 3.2 mm solder pin suitable for reflow and wave soldering. The pin headers provide space for labelling and can be coded. HC = High Current.

**General ordering data**

Type	SL-SMT 5.08HC/03/270GH ...	Version	Product data	Packaging
Order No.	<a href="#">1877600000</a>	PCB plug-in connector, male header, closed side, THT/THR solder connection, 5.08 mm, Number of poles: 3, 270°, Solder pin length (l): 1.5 mm, tinned, black, Tape	IEC: 400 V / 27.5 A UL: 300 V / 18.5 A	Tape
GTIN (EAN)	4032248468195			
Qty.	335 pc(s).			
Type	SL-SMT 5.08HC/03/270GH ...	Version	Product data	Packaging
Order No.	<a href="#">1877820000</a>	PCB plug-in connector, male header, closed side, THT/THR solder connection, 5.08 mm, Number of poles: 3, 270°, Solder pin length (l): 3.2 mm, tinned, black, Tape	IEC: 400 V / 27.5 A UL: 300 V / 18.5 A	Tape
GTIN (EAN)	4032248468478			
Qty.	335 pc(s).			

**SL 5.08/180**

Male connectors with straight outlet direction. The solder pin length is optimised for wave flow soldering. The pin headers provide space for labelling and can be coded.

**General ordering data**

Type	SL 5.08/03/180 3.2SN BK ...	Version	Product data	Packaging
Order No.	<a href="#">1517310000</a>	PCB plug-in connector, male header, open side, THT solder connection, 5.08 mm, Number of poles: 3, 180°, Solder pin length (l): 3.2 mm, tinned, black, Box	IEC: 400 V / 18 A UL: 300 V / 15 A	Box
GTIN (EAN)	4008190192990			
Qty.	100 pc(s).			
Type	SL 5.08/03/180 3.2SN OR ...	Version	Product data	Packaging
Order No.	<a href="#">1517360000</a>	PCB plug-in connector, male header, open side, THT solder connection, 5.08 mm, Number of poles: 3, 180°, Solder pin length (l): 3.2 mm, tinned, orange, Box	IEC: 400 V / 18 A UL: 300 V / 15 A	Box
GTIN (EAN)	4008190057077			
Qty.	100 pc(s).			

**OMNIMATE Signal - series BL/SL 5.08  
BLDT 5.08/03/-B SN OR BX**

**Weidmüller Interface GmbH & Co. KG**  
Klingenbergstraße 26  
D-32758 Detmold  
Germany  
Fon: +49 5231 14-0  
Fax: +49 5231 14-292083  
www.weidmuller.com

**Mating connector (fully pluggable)**
**SLS 5.08/180 SN**

Male plugs with clamping-yoke screw wire-connect system. The male plugs provide space for labelling and can be coded.

**General ordering data**

Type	SLS 5.08/03/180 SN OR BX	Version	Product data	Packaging
Order No.	<a href="#">1627100000</a>	PCB plug-in connector, male plug, 5.08 mm, Number of poles: 3,	IEC: 400 V / 21.5 A / 0.2 - 2.5 mm <sup>2</sup>	Box
GTIN (EAN)	4008190199616	180°, Clamping yoke connection, Clamping range, max. : 3.31 mm <sup>2</sup> ,	UL: 300 V / 14 A / AWG 26 - AWG 12	
Qty.	120 pc(s).	Box		

**SL-SMT 5.08HC/90 Tape**

High-temperature-resistant, 90° angled, open male header. Packed in box or tape. On tape, with 1.5 mm solder pin, optimised for automatic assembly. 3.2 mm solder pin suitable for reflow and wave soldering. The pin headers provide space for labelling and can be coded. HC = High Current.

**General ordering data**

Type	SL-SMT 5.08HC/03/90 1.5 ...	Version	Product data	Packaging
Order No.	<a href="#">1821170000</a>	PCB plug-in connector, male header, open side, THT/THR solder	IEC: 400 V / 27.5 A	Tape
GTIN (EAN)	4032248319817	connection, 5.08 mm, Number of poles: 3, 90°, Solder pin length (l):	UL: 300 V / 18.5 A	
Qty.	350 pc(s).	1.5 mm, tinned, black, Tape		

**OMNIMATE Signal - series BL/SL 5.08  
BLDT 5.08/03/-B SN OR BX**

**Weidmüller Interface GmbH & Co. KG**  
Klingenbergstraße 26  
D-32758 Detmold  
Germany  
Fon: +49 5231 14-0  
Fax: +49 5231 14-292083  
www.weidmueller.com

**Mating connector (fully pluggable)**
**SL-SMT 5.08HC/90G Tape**

High-temperature-resistant pin header, packed in box or tape. On tape, with 1.5 mm solder pin, optimised for automatic assembly. 3.2 mm solder pin suitable for reflow and wave soldering. The pin headers provide space for labelling and can be coded. HC = High Current.

**General ordering data**

Type	SL-SMT 5.08HC/03/90G 1. ...	Version	Product data	Packaging
Order No.	<a href="#">1775014001</a>	PCB plug-in connector, male header, closed side, THT/THR solder connection, 5.08 mm, Number of poles: 3, 90°, Solder pin length (l): 1.5 mm, tinned, black, Tape	IEC: 400 V / 27.5 A UL: 300 V / 18.5 A	Tape
GTIN (EAN)	4032248167739			
Qty.	350 pc(s).			
Type	SL-SMT 5.08HC/03/90G 3. ...	Version	Product data	Packaging
Order No.	<a href="#">1272720000</a>	PCB plug-in connector, male header, closed side, THT/THR solder connection, 5.08 mm, Number of poles: 3, 90°, Solder pin length (l): 3.2 mm, tinned, black, Tape	IEC: 400 V / 27.5 A UL: 300 V / 18.5 A	Tape
GTIN (EAN)	4050118061789			
Qty.	350 pc(s).			

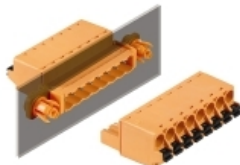
**SLF 5.08/180DF SN**

Male plug with PUSH IN wire connection and straight outlet direction, when used with BLF 5.08HC as wire-to-wire application for panel feed-through The male plugs provide space for labelling and can be coded.

**General ordering data**

Type	SLF 5.08/03/180DF SN OR ...	Version	Product data	Packaging
Order No.	<a href="#">1353590000</a>	PCB plug-in connector, male plug, 5.08 mm, Number of poles: 3, 180°, PUSH IN, Spring connection, Clamping range, max.: 3.31 mm <sup>2</sup> , UL: 300 V / 14 A / AWG 26 - AWG 12	IEC: 400 V / 25.9 A / 0.2 - 2.5 mm <sup>2</sup> UL: 300 V / 14 A / AWG 26 - AWG 12	Box
GTIN (EAN)	4050118156362			
Qty.	42 pc(s).	Box		

**OMNIMATE Signal - series BL/SL 5.08  
BLDT 5.08/03/-B SN OR BX**

**Weidmüller Interface GmbH & Co. KG**  
Klingenbergstraße 26  
D-32758 Detmold  
Germany  
Fon: +49 5231 14-0  
Fax: +49 5231 14-292083  
www.weidmueller.com

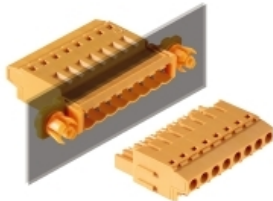
**Mating connector (fully pluggable)**
**SLT 5.08/180DF SN**

Male plugs with screw TOP wire connection. The male plug provides space for labelling and can be coded.

**General ordering data**

Type	SLT 5.08/03/180DF SN OR ...	Version	Product data	Packaging
Order No.	<a href="#">1353370000</a>	PCB plug-in connector, male plug, 5.08 mm, Number of poles: 3,	IEC: 400 V / 16 A / 0.2 - 2.5 mm <sup>2</sup>	Box
GTIN (EAN)	4050118155853	180°, TOP connection, Clamping range, max. : 2.5 mm <sup>2</sup> , Box	UL: 300 V / 15 A / AWG 26 - AWG 14	
Qty.	42 pc(s).			

**SL-SMT 5.08/180 Box**

High-temperature-resistant, straight, open pin header. Packed in box or tape. On tape and with 1.5 mm solder pin, optimised for automatic assembly. 3.2 mm solder pin suitable for reflow and wave soldering. The pin headers provide space for labelling and can be coded. HC = High Current.

**General ordering data**

Type	SL-SMT 5.08HC/03/180 3. ...	Version	Product data	Packaging
Order No.	<a href="#">1837990000</a>	PCB plug-in connector, male header, open side, THT/THR solder	IEC: 400 V / 27.5 A	Box
GTIN (EAN)	4032248348053	connection, 5.08 mm, Number of poles: 3, 180°, Solder pin length (l):	UL: 300 V / 18.5 A	
Qty.	100 pc(s).	3.2 mm, tinned, black, Box		
Type	SL-SMT 5.08HC/03/180 1. ...	Version	Product data	Packaging
Order No.	<a href="#">1775572001</a>	PCB plug-in connector, male header, open side, THT/THR solder	IEC: 400 V / 27.5 A	Box
GTIN (EAN)	4032248157556	connection, 5.08 mm, Number of poles: 3, 180°, Solder pin length (l):	UL: 300 V / 18.5 A	
Qty.	100 pc(s).	1.5 mm, tinned, black, Box		



**OMNIMATE Signal - series BL/SL 5.08  
BLDT 5.08/03/-B SN OR BX**

**Weidmüller Interface GmbH & Co. KG**  
 Klingenbergstraße 26  
 D-32758 Detmold  
 Germany  
 Fon: +49 5231 14-0  
 Fax: +49 5231 14-292083  
 www.weidmueller.com

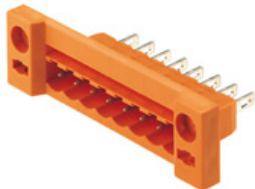
**Mating connector (fully pluggable)**
**SLDF 5.08**

Male connector for through-panel mounting with optional locking function. Internal connection as flat-blade or solder connection. These male connectors provide space for labelling and can be coded.

**General ordering data**

Type	SLDF 5.08 L/F 3 SN OR BX	Version	Product data	Packaging
Order No.	<a href="#">1599140000</a>	PCB plug-in connector, male header, 5.08 mm, Number of poles: 3,	IEC: 400 V / 15 A	Box
GTIN (EAN)	4008190077853	180°, Flat-blade connection, Solder connection, Box	UL: 300 V / 10 A	
Qty.	48 pc(s).			
Type	SLDF 5.08 L/F 3 SN BK BX	Version	Product data	Packaging
Order No.	<a href="#">1635750000</a>	PCB plug-in connector, male header, 5.08 mm, Number of poles: 3,	IEC: 400 V / 15 A	Box
GTIN (EAN)	4008190264185	180°, Flat-blade connection, Solder connection, Box	UL: 300 V / 10 A	
Qty.	48 pc(s).			

## OMNIMATE Signal - series BL/SL 5.08 BLDT 5.08/03/-B SN OR BX

**Weidmüller Interface GmbH & Co. KG**  
Klingenbergstraße 26  
D-32758 Detmold  
Germany  
Fon: +49 5231 14-0  
Fax: +49 5231 14-292083  
www.weidmueller.com

## Accessories

### Blocks for PCB mounting



#### Minor component, major effect:

Clip-on attachment elements increase the mechanical resilience of the whole plug connection by

- securing the male connectors to the circuit board
- providing a vibration-proof connection between the sockets and the male connectors

Clip-on or pre-assembled - always the right solution:

- Hard-wearing, precise fitting dovetail joint
- Hard-wearing metal threaded inserts
- Suitable for all outlet directions

Maximum stability, minimum effort:

- Extremely resilient for frequent fastening operations
- Complete set for easy selection

The result: soldering points, contacts and overall module are more resilient against mechanical stress such as vibrations and tensile loads.

### General ordering data

Type	SLA BB1R SW	Version	Product data	Packaging
Order No.	<a href="#">1723480000</a>		PCB plug-in connector, Accessories, Mounting block, black, Number of	Box
GTIN (EAN)	4008190366032		poles: 1	
Qty.	20 pc(s).			
Type	SLA BB6R SW	Version	Product data	Packaging
Order No.	<a href="#">1723520000</a>		PCB plug-in connector, Accessories, Mounting block, black, Number of	Box
GTIN (EAN)	4008190366070		poles: 1	
Qty.	20 pc(s).			
Type	SLA BB1R OR	Version	Product data	Packaging
Order No.	<a href="#">1723430000</a>		PCB plug-in connector, Accessories, Mounting block, orange, Number	Box
GTIN (EAN)	4008190365981		of poles: 1	
Qty.	20 pc(s).			
Type	SLA BB5R OR	Version	Product data	Packaging
Order No.	<a href="#">1723460000</a>		PCB plug-in connector, Accessories, Mounting block, orange, Number	Box
GTIN (EAN)	4008190366018		of poles: 1	
Qty.	20 pc(s).			
Type	SLA BB2R SW	Version	Product data	Packaging
Order No.	<a href="#">1723490000</a>		PCB plug-in connector, Accessories, Mounting block, black, Number of	Box
GTIN (EAN)	4008190366049		poles: 1	
Qty.	20 pc(s).			
Type	SLA BB11R OR	Version	Product data	Packaging
Order No.	<a href="#">1604120000</a>		PCB plug-in connector, Accessories, Mounting block, orange, Number	Box
GTIN (EAN)	4008190182977		of poles: 1	
Qty.	20 pc(s).			
Type	SLA BB2R OR	Version	Product data	Packaging
Order No.	<a href="#">1723440000</a>		PCB plug-in connector, Accessories, Mounting block, orange, Number	Box
GTIN (EAN)	4008190365998		of poles: 1	
Qty.	20 pc(s).			

## OMNIMATE Signal - series BL/SL 5.08 BLDT 5.08/03/-B SN OR BX

**Weidmüller Interface GmbH & Co. KG**  
Klingenbergstraße 26  
D-32758 Detmold  
Germany  
Fon: +49 5231 14-0  
Fax: +49 5231 14-292083  
www.weidmueller.com

### Accessories

Type	SLA BB11R SW	Version	Product data	Packaging
Order No.	<a href="#">1692340000</a>	PCB plug-in connector, Accessories, Mounting block, black, Number of		Box
GTIN (EAN)	4008190864965	poles: 1		
Qty.	20 pc(s).			
Type	SLA BB12R SW	Version	Product data	Packaging
Order No.	<a href="#">1626880000</a>	PCB plug-in connector, Accessories, Mounting block, black, Number of		Box
GTIN (EAN)	4008190198213	poles: 1		
Qty.	100 pc(s).			
Type	SLA BB6R OR	Version	Product data	Packaging
Order No.	<a href="#">1723470000</a>	PCB plug-in connector, Accessories, Mounting block, orange, Number		Box
GTIN (EAN)	4008190366025	of poles: 1		
Qty.	20 pc(s).			
Type	SLA BB5R SW	Version	Product data	Packaging
Order No.	<a href="#">1723510000</a>	PCB plug-in connector, Accessories, Mounting block, black, Number of		Box
GTIN (EAN)	4008190366063	poles: 1		
Qty.	20 pc(s).			
Type	SLA BB12R OR	Version	Product data	Packaging
Order No.	<a href="#">1593450000</a>	PCB plug-in connector, Accessories, Mounting block, orange, Number		Box
GTIN (EAN)	4008190122164	of poles: 1		
Qty.	100 pc(s).			

### Coding elements



#### Only connects what is supposed to be connected: the right connection at the right place.

Coding elements and locking devices clearly assign connecting elements during the manufacturing process and operation

The coding elements and locking devices are inserted prior to assembly or during the cable assembly phase. The Weidmüller alternative: configure online using the variant configurator to precode prior to delivery.

Incorrect assembly on the circuit board and incorrect plugging of connecting elements is no longer possible.

The advantage: no troubleshooting during manufacture and no operational errors by the user.

### General ordering data

Type	BLZ/SL KO OR BX	Version	Product data	Packaging
Order No.	<a href="#">1573010000</a>	PCB plug-in connector, Accessories, Coding element, orange, Number		Box
GTIN (EAN)	4008190048396	of poles: 1		
Qty.	100 pc(s).			
Type	BLZ/SL KO BK BX	Version	Product data	Packaging
Order No.	<a href="#">1545710000</a>	PCB plug-in connector, Accessories, Coding element, black, Number		Box
GTIN (EAN)	4008190087142	of poles: 1		
Qty.	50 pc(s).			

DIE DEUTSCHE VERSION IST VERBINDLICH  
THE GERMAN VERSION IS BINDING

WEITERGABE SOWIE VERVIELFÄLTIGUNG DIESES DOKUMENTS, VERWERTUNG UND MITTEILUNG SEINES INHALTS SIND VERBOTEN, SOWEIT NICHT AUSDRUECKLICH GESTATET.  
ZUWIDERHANDLUNGEN VERPFLICHTEN ZU SCHADENERSATZ. ALLE RECHTE FUER DEN FALL DER PATENT-, GEBRAUCHSMUSTER- ODER GESCHMACKSMUSTEREINTRAGUNG VORBEHALTEN.  
THE REPRODUCTION, DISTRIBUTION AND UTILIZATION OF THIS DOCUMENT AS WELL AS THE COMMUNICATION OF ITS CONTENTS TO OTHERS WITHOUT EXPLICIT AUTHORIZATION IS PROHIBITED.  
OFFENDERS WILL BE HELD LIABLE FOR THE PAYMENT OF DAMAGES. ALL RIGHTS RESERVED IN THE EVENT OF THE GRANT OF A PATENT, UTILITY MODEL OR DESIGN.

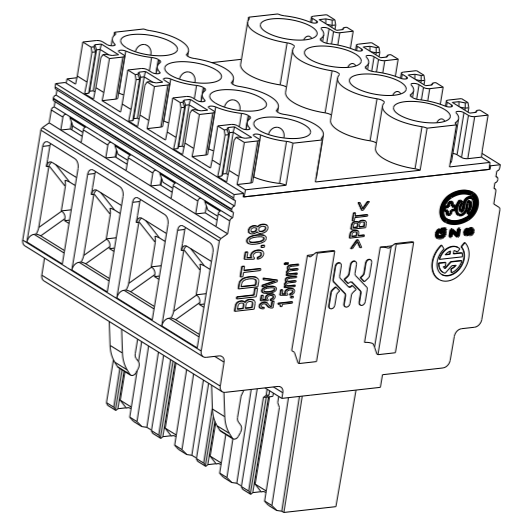
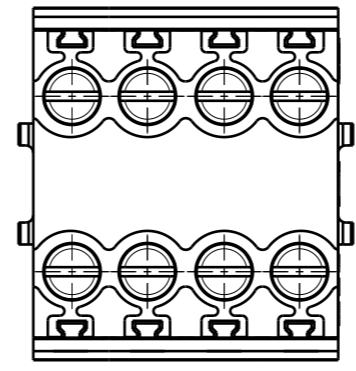
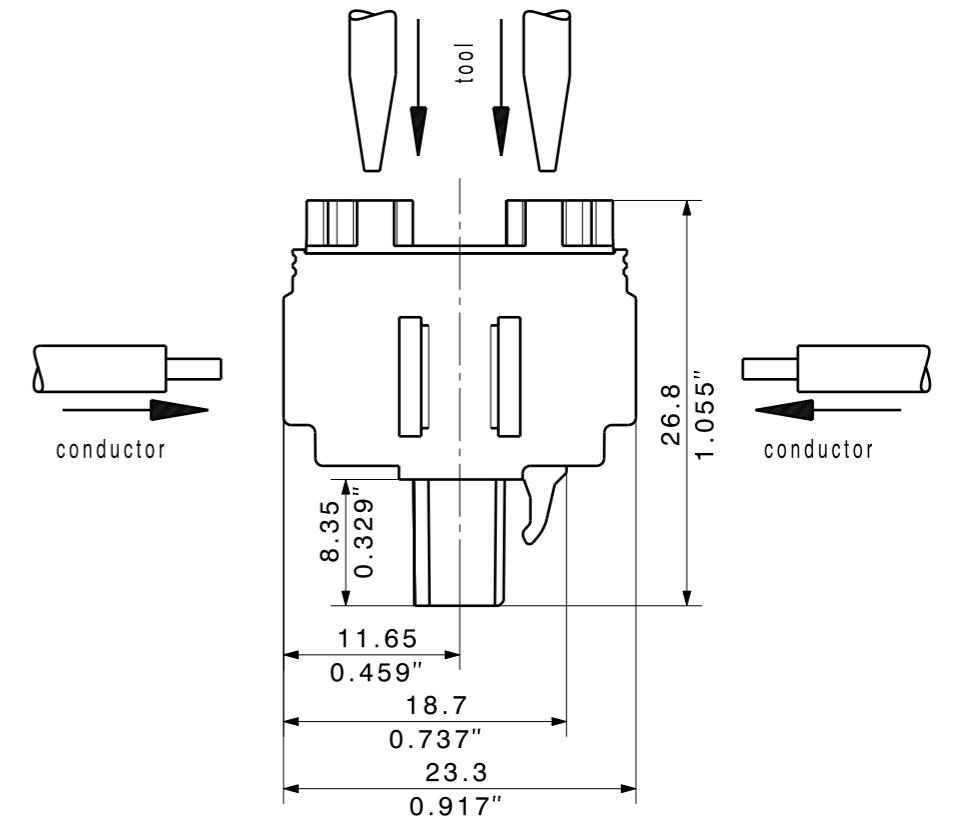
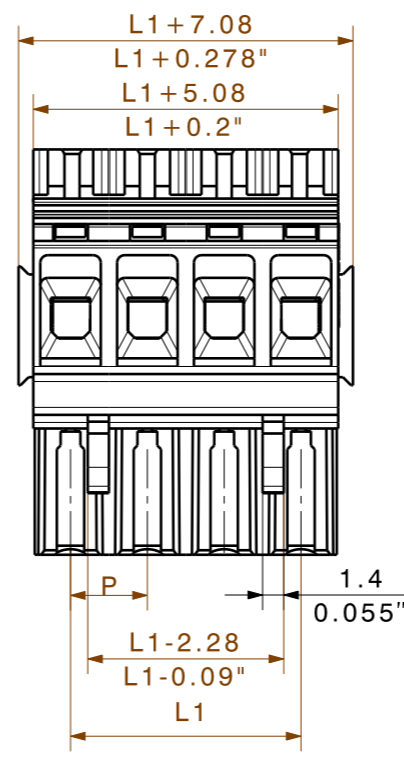

12	55,88	2,200
11	50,80	2,000
10	45,72	1,800
9	40,64	1,600
8	35,56	1,400
7	30,48	1,200
6	25,40	1,000
5	20,32	0,800
4	15,24	0,600
3	10,16	0,400
2	5,08	0,200
n	L1 [mm]	L1 [Inch]

For the mounting of PCBs, it should be noted that the rated data stated here relates only to the PCB components alone.  
The necessary creepage and clearance paths must be observed in connection with the respective applicant in accordance to IEC 664 / VDE 0110.  
The current-carrying capacity and pitch tolerance is to be determined according to DIN IEC 326 part 3 very fine.

Weidmüller PCB components are tested to the DIN EN 61984 standard, and are valid for its field of application.  
Provided that the components are used to the intended purpose, all requirements with respect to the occurring of electrical, mechanical, thermic and corrosive stress will be satisfied.

SHOWN: BLDT 5.08/04B

GENERAL TOLERANCE: DIN ISO 2768-m		78271/5 07.10.14 AMANN_A 00		CAT.NO.: .	
RoHS COMPLIANT		MODIFICATION		Weidmüller	
DRAWN		DATE	NAME	DRAWING NO. C 21389 07	
RESPONSIBLE		02.11.2007	HELIS_MA	ISSUE NO. 07	
SUPERSEDES:		CHECKED	07.10.2014	SHEET 5 OF 6 SHEETS	
SUPERSEDED BY: .		APPROVED	LANG_T	PRODUCT FILE: BLDT 5.08	
SCALE: 2:1				BLDT 5.08/../(B)	
				Buchsenleiste SOCKET BLOCK	
				7129	