

OMNIMATE Signal - series BL/SL 3.50 BL 3.50/02/270 SN BK BX

Weidmüller Interface GmbH & Co. KG
Klingenbergstraße 26
D-32758 Detmold
Germany
Fon: +49 5231 14-0
Fax: +49 5231 14-292083
www.weidmueller.com

Product image

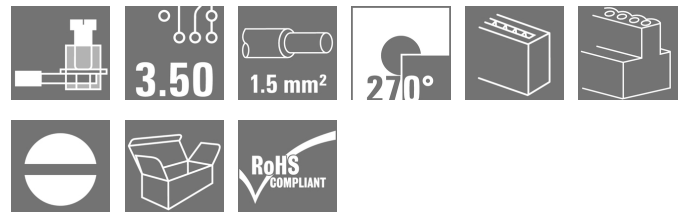

Similar to illustration

Female connectors with clamping yoke screw system for connecting conductors at 3.50 mm pitch. They provide space for labelling and can be coded.

General ordering data

Type	BL 3.50/02/270 SN BK BX
Order No.	1639700000
Version	PCB plug-in connector, female plug, 3.50 mm, Number of poles: 2, 270°, Clamping yoke connection, Clamping range, max. : 1.5 mm², Box
GTIN (EAN)	4008190277253
Qty.	258 pc(s).
Product data	IEC: 320 V / 12 A / 0.2 - 1.5 mm² UL: 300 V / 8 A / AWG 28 - AWG 14
Packaging	Box

Creation date May 3, 2020 5:29:16 PM CEST

OMNIMATE Signal - series BL/SL 3.50
BL 3.50/02/270 SN BK BX

Weidmüller Interface GmbH & Co. KG
 Klingenbergstraße 26
 D-32758 Detmold
 Germany
 Fon: +49 5231 14-0
 Fax: +49 5231 14-292083
 www.weidmueller.com

Technical data**Dimensions and weights**

Width	7 mm	Width (inches)	0.276 inch
Height	12 mm	Height (inches)	0.472 inch
Depth	22.45 mm	Depth (inches)	0.884 inch
Net weight	2.1 g		

System Parameters

Product family	OMNIMATE Signal - series BL/SL 3.50	Type of connection	Field connection
Wire connection method	Clamping yoke connection	Pitch in mm (P)	3.5 mm
Pitch in inches (P)	0.138 inch	Conductor outlet direction	270°
Number of poles	2	L1 in mm	3.5 mm
L1 in inches	0.138 inch	Number of rows	1
Pin series quantity	1	Rated cross-section	1.5 mm ²
Touch-safe protection acc. to DIN VDE 57 106	Safe from finger touch	Touch-safe protection acc. to DIN VDE 0470	IP 20
Volume resistance	≤ 5mΩ	Can be coded	Yes
Stripping length	6 mm	Tightening torque, min.	0.2 Nm
Tightening torque, max.	0.25 Nm	Clamping screw	M 2
Screwdriver blade	0.4 x 2.5	Screwdriver blade standard	DIN 5264
Plugging cycles	25	Plugging force/pole, max.	7 N
Pulling force/pole, max.	5 N		

Material data

Insulating material	PBT	Colour	black
Colour chart (similar)	RAL 9011	Insulating material group	IIIa
Comparative Tracking Index (CTI)	≥ 200	Insulation strength	≥ 10 ⁸ Ω
UL 94 flammability rating	V-0	GWFI	960 °C
Contact material	Copper alloy	Contact surface	tinned
Layer structure of plug contact	4-8 μm Sn hot-dip tinned	Storage temperature, min.	-25 °C
Storage temperature, max.	50 °C	Max. relative humidity during storage	70 %
Operating temperature, min.	-50 °C	Operating temperature, max.	100 °C
Temperature range, installation, min.	-30 °C	Temperature range, installation, max.	100 °C

Conductors suitable for connection

Clamping range, min.	0.08 mm ²
Clamping range, max.	1.5 mm ²
Wire connection cross section AWG, min.	AWG 28
Wire connection cross section AWG, max.	AWG 14
Solid, min. H05(07) V-U	0.2 mm ²
Solid, max. H05(07) V-U	1.5 mm ²
Flexible, min. H05(07) V-K	0.2 mm ²
Flexible, max. H05(07) V-K	1.5 mm ²
w. plastic collar ferrule, DIN 46228 pt 4, min.	0.2 mm ²
w. plastic collar ferrule, DIN 46228 pt 4, max.	1.5 mm ²
w. wire end ferrule, DIN 46228 pt 1, min.	0.2 mm ²
w. wire end ferrule, DIN 46228 pt 1, max.	1.5 mm ²

Creation date May 3, 2020 5:29:16 PM CEST

OMNIMATE Signal - series BL/SL 3.50
BL 3.50/02/270 SN BK BX

Weidmüller Interface GmbH & Co. KG
 Klingenbergstraße 26
 D-32758 Detmold
 Germany
 Fon: +49 5231 14-0
 Fax: +49 5231 14-292083
 www.weidmueller.com

Technical data

Plug gauge in accordance with EN 60999 a x b; ø 2.4 mm x 1.5 mm

Clampable conductor	Cross-section for conductor connection	Type	fine-wired
		nominal	0.5 mm ²
wire end ferrule	Stripping length	nominal	8 mm
		Recommended wire-end ferrule	H0.5/12 OR
		nominal	6 mm
		Recommended wire-end ferrule	H0.5/6
Cross-section for conductor connection	Type	fine-wired	
	nominal	0.75 mm ²	
wire end ferrule	Stripping length	nominal	8 mm
		Recommended wire-end ferrule	H0.75/12 W
		nominal	6 mm
		Recommended wire-end ferrule	H0.75/6
Cross-section for conductor connection	Type	fine-wired	
	nominal	1 mm ²	
wire end ferrule	Stripping length	nominal	8 mm
		Recommended wire-end ferrule	H1.0/12 GE
		nominal	6 mm
		Recommended wire-end ferrule	H1.0/6
Cross-section for conductor connection	Type	fine-wired	
	nominal	0.25 mm ²	
wire end ferrule	Stripping length	nominal	8 mm
		Recommended wire-end ferrule	H0.25/10 HBL
		nominal	5 mm
		Recommended wire-end ferrule	H0.25/5
Cross-section for conductor connection	Type	fine-wired	
	nominal	0.34 mm ²	
wire end ferrule	Stripping length	nominal	8 mm
	Recommended wire-end ferrule	H0.34/10 TK	

Reference text The outside diameter of the plastic collar should not be larger than the pitch (P). Length of ferrules is to be chosen depending on the product and the rated voltage.

Max. clamping range 1.5 mm²

Rated data acc. to IEC

tested acc. to standard	IEC 60664-1, IEC 61984	Rated current, min. number of poles (Tu=20°C)	12 A
Rated current, max. number of poles (Tu=20°C)	10 A	Rated current, min. number of poles (Tu=40°C)	10 A
Rated current, max. number of poles (Tu=40°C)	8 A	Rated voltage for surge voltage class / pollution degree II/2	320 V
Rated voltage for surge voltage class / pollution degree III/2	160 V	Rated voltage for surge voltage class / pollution degree III/3	160 V
Rated impulse voltage for surge voltage class/ pollution degree II/2	2.5 kV	Rated impulse voltage for surge voltage class/ pollution degree III/2	2.5 kV
Rated impulse voltage for surge voltage class/ contamination degree III/3	2.5 kV	Short-time withstand current resistance	3 x 1s with 100 A

**OMNIMATE Signal - series BL/SL 3.50
BL 3.50/02/270 SN BK BX**

Weidmüller Interface GmbH & Co. KG
 Klingenbergstraße 26
 D-32758 Detmold
 Germany
 Fon: +49 5231 14-0
 Fax: +49 5231 14-292083
 www.weidmueller.com

Technical data**Rated data acc. to CSA**

Institute (CSA)



Certificate No. (CSA)

154685-1318353

Rated voltage (Use group B / CSA)	300 V
Rated current (Use group B / CSA)	10 A
Wire cross-section, AWG, min.	AWG 28
Reference to approval values	Specifications are maximum values, details - see approval certificate.

Rated voltage (Use group D / CSA)	300 V
Rated current (Use group D / CSA)	10 A
Wire cross-section, AWG, max.	AWG 14

Rated data acc. to UL 1059

Institute (UR)



Certificate No. (UR)

E60693

Rated voltage (Use group B / UL 1059)	300 V
Rated current (Use group B / UL 1059)	8 A
Wire cross-section, AWG, min.	AWG 28
Reference to approval values	Specifications are maximum values, details - see approval certificate.

Rated voltage (Use group D / UL 1059)	300 V
Rated current (Use group D / UL 1059)	8 A
Wire cross-section, AWG, max.	AWG 14

Packing

Packaging	Box	VPE length	58 mm
VPE width	72 mm	VPE height	113 mm

Classifications

ETIM 6.0	EC002638	ETIM 7.0	EC002638
eClass 9.0	27-44-03-09	eClass 9.1	27-44-03-09
eClass 10.0	27-44-03-09	UNSPSC	30-21-18-10

Data sheet

**OMNIMATE Signal - series BL/SL 3.50
BL 3.50/02/270 SN BK BX**

Weidmüller Interface GmbH & Co. KG
Klingenbergstraße 26
D-32758 Detmold
Germany
Fon: +49 5231 14-0
Fax: +49 5231 14-292083
www.weidmueller.com

Technical data

Notes

Notes	<ul style="list-style-type: none"> • Additional colours on request • Gold-plated contact surfaces on request • Rated current related to rated cross-section & min. No. of poles. • Max. outer diameter of the conductor: 2.9 mm • Wire end ferrule without plastic collar to DIN 46228/1 • Wire end ferrule with plastic collar to DIN 46228/4 • P on drawing = pitch • Rated data refer only to the component itself. Clearance and creepage distances to other components are to be designed in accordance with the relevant application standards.
IPC conformity	Conformity: The products are developed, manufactured and delivered according international recognized standards and norms and comply with the assured properties in the data sheet resp. fulfill decorative properties in accordance with IPC-A-610 "Class 2". Further claims on the products can be evaluated on request.

Approvals

Approvals



ROHS

Conform

Downloads

Approval/Certificate/Document of Conformity	Declaration of the Manufacturer
Brochure/Catalogue	FL DRIVES EN MB DEVICE MANUF. EN FL DRIVES DE CAT 2 PORTFOLIOGUIDE EN FL BUILDING SAFETY EN FL APPL LED LIGHTING EN FLIndustr.CONTROLS EN FL MACHINE SAFETY EN FL HEATING ELECTRN EN FL APPL INVERTER EN FL_BASE_STATION EN FL ELEVATOR EN FL POWER SUPPLY EN FL 72H SAMPLE SER EN PO OMNIMATE EN
Engineering Data	STEP

**OMNIMATE Signal - series BL/SL 3.50
BL 3.50/02/270 SN BK BX**

Weidmüller Interface GmbH & Co. KG
Klingenbergstraße 26
D-32758 Detmold
Germany
Fon: +49 5231 14-0
Fax: +49 5231 14-292083
www.weidmueller.com

Drawings

Dimensional drawing

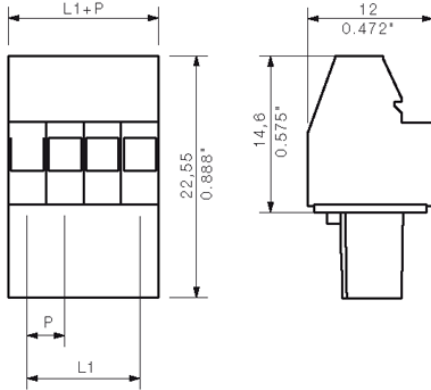

Graph

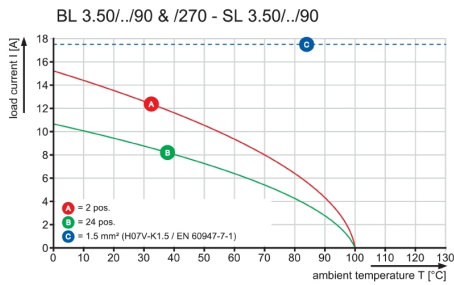

Graph

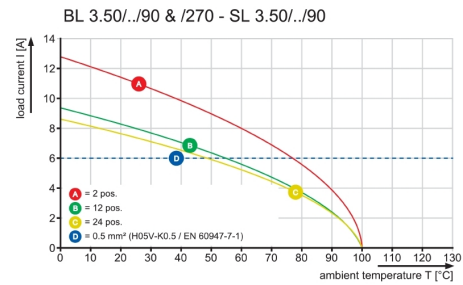

**OMNIMATE Signal - series BL/SL 3.50
BL 3.50/02/270 SN BK BX**

Weidmüller Interface GmbH & Co. KG
Klingenbergstraße 26
D-32758 Detmold
Germany
Fon: +49 5231 14-0
Fax: +49 5231 14-292083
www.weidmueller.com

Mating connector (conditionally pluggable)
SL-SMT 3.50/90F Tape



High-temperature-resistant male header, 3.50 mm pitch.

- **Plugging direction parallel (90°), straight 180° or angled (135°) to PCB**
- **Housing variants: closed side (G), screw flange (F), solder flange (LF) or snap-on solder flange (RF)**
- **Optimised for the SMT process**
- **Pin length 3.2 mm universal for all soldering methods**
- **Pin length 1.5 mm optimised for reflow soldering methods**
- **Packed either in a box (BX) or tape-on-reel (RL)**
- **Male header can be coded**

General ordering data

Type	SL-SMT 3.50/02/90F 1.5S ...	Version	Product data	Packaging
Order No.	1762004001	PCB plug-in connector, male header, Flange, THT/THR solder connection, 3.50 mm, Number of poles: 2, 90°, Solder pin length (l): 1.5 mm, tinned, black, Tape	IEC: 320 V / 15 A UL: 300 V / 10 A	Tape
GTIN (EAN)	4032248136186			
Qty.	385 pc(s).			

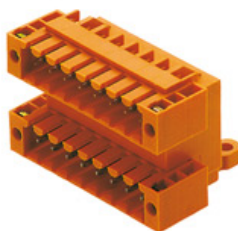
Type	SL-SMT 3.50/02/90F 1.5S ...	Version	Product data	Packaging
Order No.	1762004002	PCB plug-in connector, male header, Flange, THT/THR solder connection, 3.50 mm, Number of poles: 2, 90°, Solder pin length (l): 1.5 mm, tinned, black, Tape	IEC: 320 V / 15 A UL: 300 V / 10 A	Tape
GTIN (EAN)	4032248193516			
Qty.	385 pc(s).			

SLD 3.50/90F

Two-tier pin header for wave soldering in 3.50 mm pitch. The connector is available in open, closed and flange versions. The male connectors provide space for labelling and can be coded. Packed in a cardboard box.

General ordering data

Type	SLD 3.50/04/90F 3.2SN O ...	Version	Product data	Packaging
Order No.	1633810000	PCB plug-in connector, male header, Flange, THT solder connection, 3.50 mm, Number of poles: 4, 90°, Solder pin length (l): 3.2 mm, tinned, orange, Box	IEC: 200 V / 10.5 A UL: 300 V / 8 A	Box
GTIN (EAN)	4008190258269			
Qty.	50 pc(s).			

OMNIMATE Signal - series BL/SL 3.50
BL 3.50/02/270 SN BK BX

Weidmüller Interface GmbH & Co. KG
 Klingenbergstraße 26
 D-32758 Detmold
 Germany
 Fon: +49 5231 14-0
 Fax: +49 5231 14-292083
 www.weidmueller.com

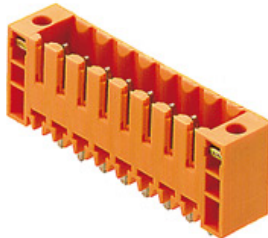
Mating connector (conditionally pluggable)**SL 3.50/180F**

Pin headers for wave soldering in 3.50 mm pitch

- Plugging direction is parallel (90°), straight 180° or angled (135°) to the PCB
- Housing variant: screw flange (F)
- Packed in a cardboard box (BX)
- Pin header can be coded

General ordering data

Type	SL 3.50/02/180F 4.5 SN ...	Version	Product data	Packaging
Order No.	1618690000	PCB plug-in connector, male header, Flange, THT solder connection,	IEC: 320 V / 17 A	Box
GTIN (EAN)	4008190126452	3.50 mm, Number of poles: 2, 180°, Solder pin length (l): 4.5 mm,	UL: 300 V / 10 A	
Qty.	100 pc(s).	tinned, orange, Box		
Type	SL 3.50/02/180F 3.2SN D ...	Version	Product data	Packaging
Order No.	1622490000	PCB plug-in connector, male header, Flange, THT solder connection,	IEC: 320 V / 17 A	Box
GTIN (EAN)	4008190193157	3.50 mm, Number of poles: 2, 180°, Solder pin length (l): 3.2 mm,	UL: 300 V / 10 A	
Qty.	100 pc(s).	tinned, Signal green, Box		
Type	SL 3.50/02/180F 3.2SN O ...	Version	Product data	Packaging
Order No.	1607500000	PCB plug-in connector, male header, Flange, THT solder connection,	IEC: 320 V / 17 A	Box
GTIN (EAN)	4008190180317	3.50 mm, Number of poles: 2, 180°, Solder pin length (l): 3.2 mm,	UL: 300 V / 10 A	
Qty.	100 pc(s).	tinned, orange, Box		
Type	SL 3.50/02/180F 3.2SN G ...	Version	Product data	Packaging
Order No.	1622260000	PCB plug-in connector, male header, Flange, THT solder connection,	IEC: 320 V / 17 A	Box
GTIN (EAN)	4008190189730	3.50 mm, Number of poles: 2, 180°, Solder pin length (l): 3.2 mm,	UL: 300 V / 10 A	
Qty.	100 pc(s).	tinned, Pebble grey, Box		
Type	SL 3.50/02/180F 4.5 SN ...	Version	Product data	Packaging
Order No.	1616140000	PCB plug-in connector, male header, Flange, THT solder connection,	IEC: 320 V / 17 A	Box
GTIN (EAN)	4008190067854	3.50 mm, Number of poles: 2, 180°, Solder pin length (l): 4.5 mm,	UL: 300 V / 10 A	
Qty.	100 pc(s).	tinned, black, Box		

**OMNIMATE Signal - series BL/SL 3.50
BL 3.50/02/270 SN BK BX**

Weidmüller Interface GmbH & Co. KG
Klingenbergstraße 26
D-32758 Detmold
Germany
Fon: +49 5231 14-0
Fax: +49 5231 14-292083
www.weidmueller.com

Mating connector (conditionally pluggable)
SL-SMT 3.5/90F Box

High-temperature-resistant male header, 3.50 mm pitch.

- **Plugging direction parallel (90°), straight 180° or angled (135°) to PCB**
- **Housing variants: closed side (G), screw flange (F), solder flange (LF) or snap-on solder flange (RF)**
- **Optimised for the SMT process**
- **Pin length 3.2 mm universal for all soldering methods**
- **Pin length 1.5 mm optimised for reflow soldering methods**
- **Packed either in a box (BX) or tape-on-reel (RL)**
- **Male header can be coded**

General ordering data

Type	SL-SMT 3.50/02/90F 1.5S ...	Version	Product data	Packaging
Order No.	1762002001	PCB plug-in connector, male header, Flange, THT/THR solder connection, 3.50 mm, Number of poles: 2, 90°, Solder pin length (l): 1.5 mm, tinned, black, Box	IEC: 320 V / 15 A UL: 300 V / 10 A	Box
GTIN (EAN)	4032248132416			
Qty.	132 pc(s).			
Type	SL-SMT 3.50/02/90F 3.2S ...	Version	Product data	Packaging
Order No.	1842080000	PCB plug-in connector, male header, Flange, THT/THR solder connection, 3.50 mm, Number of poles: 2, 90°, Solder pin length (l): 3.2 mm, tinned, black, Box	IEC: 320 V / 15 A UL: 300 V / 10 A	Box
GTIN (EAN)	4032248353439			
Qty.	132 pc(s).			

**OMNIMATE Signal - series BL/SL 3.50
BL 3.50/02/270 SN BK BX**

Weidmüller Interface GmbH & Co. KG
Klingenbergstraße 26
D-32758 Detmold
Germany
Fon: +49 5231 14-0
Fax: +49 5231 14-292083
www.weidmueller.com

Mating connector (conditionally pluggable)
SL-SMT 3.5/90LF Tape

High-temperature-resistant male header, 3.50 mm pitch.

- **Plugging direction parallel (90°), straight 180° or angled (135°) to PCB**
- **Housing variants: closed side (G), screw flange (F), solder flange (LF) or snap-on solder flange (RF)**
- **Optimised for the SMT process**
- **Pin length 3.2 mm universal for all soldering methods**
- **Pin length 1.5 mm optimised for reflow soldering methods**
- **Packed either in a box (BX) or tape-on-reel (RL)**
- **Male header can be coded**

General ordering data

Type	SL-SMT 3.50/02/90LF 1.5 ...	Version	Product data	Packaging
Order No.	1805310000	PCB plug-in connector, male header, Solder flange, THT/THR solder connection, 3.50 mm, Number of poles: 2, 90°, Solder pin length (l): 1.5 mm, tinned, black, Tape	IEC: 320 V / 15 A UL: 300 V / 10 A	Tape
GTIN (EAN)	4032248269761			
Qty.	385 pc(s).			

SL 3.50/135F

Pin headers for wave soldering in 3.50 mm pitch

- Plugging direction is parallel (90°), straight 180° or angled (135°) to the PCB
- Housing variant: screw flange (F)
- Packed in a cardboard box (BX)
- Pin header can be coded

General ordering data

Type	SL 3.50/02/135F 3.2SN O ...	Version	Product data	Packaging
Order No.	1643330000	PCB plug-in connector, male header, Flange, THT solder connection, 3.50 mm, Number of poles: 2, 135°, Solder pin length (l): 3.2 mm, tinned, orange, Box	IEC: 320 V / 15 A UL: 300 V / 10 A	Box
GTIN (EAN)	4008190282097			
Qty.	132 pc(s).			

**OMNIMATE Signal - series BL/SL 3.50
BL 3.50/02/270 SN BK BX**

Weidmüller Interface GmbH & Co. KG
Klingenbergstraße 26
D-32758 Detmold
Germany
Fon: +49 5231 14-0
Fax: +49 5231 14-292083
www.weidmueller.com

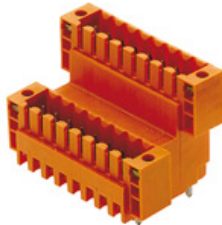
Mating connector (conditionally pluggable)
SLD 3.50V/180F

Double-level, staggered pin header for wave soldering at 3.50 mm pitch. They are available in closed and flanged versions. The male connectors provide space for labelling and can be coded.

General ordering data

Type	SLD 3.50 V/04/180F 3.2 ...	Version	Product data	Packaging
Order No.	1641240000	PCB plug-in connector, male header, Flange, THT solder connection,	IEC: 200 V / 10.5 A	Box
GTIN (EAN)	4008190279646	3.50 mm, Number of poles: 4, 180°, Solder pin length (l): 3.2 mm,	UL: 300 V / 8 A	
Qty.	50 pc(s).	tinned, orange, Box		

SL-SMT 3.5/90LF Box

High-temperature-resistant male header, 3.50 mm pitch.

- **Plugging direction parallel (90°), straight 180° or angled (135°) to PCB**
- **Housing variants: closed side (G), screw flange (F), solder flange (LF) or snap-on solder flange (RF)**
- **Optimised for the SMT process**
- **Pin length 3.2 mm universal for all soldering methods**
- **Pin length 1.5 mm optimised for reflow soldering methods**
- **Packed either in a box (BX) or tape-on-reel (RL)**
- **Male header can be coded**

General ordering data

Type	SL-SMT 3.50/02/90LF 1.5 ...	Version	Product data	Packaging
Order No.	1804940000	PCB plug-in connector, male header, Solder flange, THT/THR solder	IEC: 320 V / 15 A	Box
GTIN (EAN)	4032248268849	connection, 3.50 mm, Number of poles: 2, 90°, Solder pin length (l):	UL: 300 V / 10 A	
Qty.	132 pc(s).	1.5 mm, tinned, black, Box		
Type	SL-SMT 3.50/02/90LF 3.2 ...	Version	Product data	Packaging
Order No.	1841860000	PCB plug-in connector, male header, Solder flange, THT/THR solder	IEC: 320 V / 15 A	Box
GTIN (EAN)	4032248353217	connection, 3.50 mm, Number of poles: 2, 90°, Solder pin length (l):	UL: 300 V / 10 A	
Qty.	132 pc(s).	3.2 mm, tinned, black, Box		

**OMNIMATE Signal - series BL/SL 3.50
BL 3.50/02/270 SN BK BX**

Weidmüller Interface GmbH & Co. KG
Klingenbergstraße 26
D-32758 Detmold
Germany
Fon: +49 5231 14-0
Fax: +49 5231 14-292083
www.weidmueller.com

Mating connector (conditionally pluggable)
SL-SMT 3.5/180F Box

High-temperature-resistant male header, 3.50 mm pitch.

- **Plugging direction parallel (90°), straight 180° or angled (135°) to PCB**
- **Housing variants: closed side (G), screw flange (F), solder flange (LF) or snap-on solder flange (RF)**
- **Optimised for the SMT process**
- **Pin length 3.2 mm universal for all soldering methods**
- **Pin length 1.5 mm optimised for reflow soldering methods**
- **Packed either in a box (BX) or tape-on-reel (RL)**
- **Male header can be coded**

General ordering data

Type	SL-SMT 3.50/02/180F 1.5 ...	Version	Product data	Packaging
Order No.	1760962001	PCB plug-in connector, male header, Flange, THT/THR solder connection, 3.50 mm, Number of poles: 2, 180°, Solder pin length (l): 1.5 mm, tinned, black, Box	IEC: 320 V / 15 A UL: 300 V / 10 A	Box
GTIN (EAN)	4032248131532			
Qty.	132 pc(s).			
Type	SL-SMT 3.50/02/180F 3.2 ...	Version	Product data	Packaging
Order No.	1842770000	PCB plug-in connector, male header, Flange, THT/THR solder connection, 3.50 mm, Number of poles: 2, 180°, Solder pin length (l): 3.2 mm, tinned, black, Box	IEC: 320 V / 15 A UL: 300 V / 10 A	Box
GTIN (EAN)	4032248354139			
Qty.	132 pc(s).			

SLD 3.50V/90F

Double-level, staggered pin header for wave soldering at 3.50 mm pitch. They are available in closed and flanged versions. The male connectors provide space for labelling and can be coded.

General ordering data

Type	SLD 3.50 V/04/90F 3.2 S ...	Version	Product data	Packaging
Order No.	1642370000	PCB plug-in connector, male header, Flange, THT solder connection, 3.50 mm, Number of poles: 4, 90°, Solder pin length (l): 3.2 mm, tinned, orange, Box	IEC: 200 V / 10.5 A UL: 300 V / 8 A	Box
GTIN (EAN)	4008190280895			
Qty.	50 pc(s).			

**OMNIMATE Signal - series BL/SL 3.50
BL 3.50/02/270 SN BK BX**

Weidmüller Interface GmbH & Co. KG
Klingenbergstraße 26
D-32758 Detmold
Germany
Fon: +49 5231 14-0
Fax: +49 5231 14-292083
www.weidmueller.com

Mating connector (conditionally pluggable)
SL-SMT 3.5/180LF Tape

High-temperature-resistant male header, 3.50 mm pitch.

- **Plugging direction parallel (90°), straight 180° or angled (135°) to PCB**
- **Housing variants: closed side (G), screw flange (F), solder flange (LF) or snap-on solder flange (RF)**
- **Optimised for the SMT process**
- **Pin length 3.2 mm universal for all soldering methods**
- **Pin length 1.5 mm optimised for reflow soldering methods**
- **Packed either in a box (BX) or tape-on-reel (RL)**
- **Male header can be coded**

General ordering data

Type	SL-SMT 3.50/02/180LF 1. ...	Version	Product data	Packaging
Order No.	1805210000	PCB plug-in connector, male header, Solder flange, THT/THR solder connection, 3.50 mm, Number of poles: 2, 180°, Solder pin length (l): 1.5 mm, tinned, black, Tape	IEC: 320 V / 15 A UL: 300 V / 10 A	Tape
GTIN (EAN)	4032248269099			
Qty.	265 pc(s).			

SL-SMT 3.5/180G Box

High-temperature-resistant male header, 3.50 mm pitch.

- **Plugging direction parallel (90°), straight 180° or angled (135°) to PCB**
- **Housing variants: closed side (G), screw flange (F), solder flange (LF) or snap-on solder flange (RF)**
- **Optimised for the SMT process**
- **Pin length 3.2 mm universal for all soldering methods**
- **Pin length 1.5 mm optimised for reflow soldering methods**
- **Packed either in a box (BX) or tape-on-reel (RL)**
- **Male header can be coded**

General ordering data

Type	SL-SMT 3.50/02/180G 3.2 ...	Version	Product data	Packaging
Order No.	1842320000	PCB plug-in connector, male header, closed side, THT/THR solder connection, 3.50 mm, Number of poles: 2, 180°, Solder pin length (l): 3.2 mm, tinned, black, Box	IEC: 320 V / 15 A UL: 300 V / 10 A	Box
GTIN (EAN)	4032248353668			
Qty.	100 pc(s).			

**OMNIMATE Signal - series BL/SL 3.50
BL 3.50/02/270 SN BK BX**

Weidmüller Interface GmbH & Co. KG
Klingenbergstraße 26
D-32758 Detmold
Germany
Fon: +49 5231 14-0
Fax: +49 5231 14-292083
www.weidmueller.com

Mating connector (conditionally pluggable)

Type	SL-SMT 3.50/02/180G 1.5 ...	Version	Product data	Packaging
Order No.	1752982001	PCB plug-in connector, male header, closed side, THT/THR solder	IEC: 320 V / 15 A	Box
GTIN (EAN)	4032248130887	connection, 3.50 mm, Number of poles: 2, 180°, Solder pin length (l): 1.5 mm, tinned, black, Box	UL: 300 V / 10 A	
Qty.	100 pc(s).			

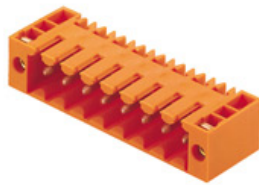
SL 3.50/90F

Pin headers for wave soldering in 3.50 mm pitch

- Plugging direction is parallel (90°), straight 180° or angled (135°) to the PCB
- Housing variant: screw flange (F)
- Packed in a cardboard box (BX)
- Pin header can be coded

General ordering data

Type	SL 3.50/02/90F 3.2SN GY ...	Version	Product data	Packaging
Order No.	1619850000	PCB plug-in connector, male header, Flange, THT solder connection,	IEC: / 17 A	Box
GTIN (EAN)	4008190148270	3.50 mm, Number of poles: 2, 90°, Solder pin length (l): 3.2 mm,	UL: 300 V / 10 A	
Qty.	100 pc(s).	tinned, Pebble grey, Box		
Type	SL 3.50/02/90F 3.2SN OR ...	Version	Product data	Packaging
Order No.	1607040000	PCB plug-in connector, male header, Flange, THT solder connection,	IEC: / 17 A	Box
GTIN (EAN)	4008190061234	3.50 mm, Number of poles: 2, 90°, Solder pin length (l): 3.2 mm,	UL: 300 V / 10 A	
Qty.	100 pc(s).	tinned, orange, Box		
Type	SL 3.50/02/90F 3.2SN DK ...	Version	Product data	Packaging
Order No.	1620080000	PCB plug-in connector, male header, Flange, THT solder connection,	IEC: / 17 A	Box
GTIN (EAN)	4008190151324	3.50 mm, Number of poles: 2, 90°, Solder pin length (l): 3.2 mm,	UL: 300 V / 10 A	
Qty.	100 pc(s).	tinned, Signal green, Box		
Type	SL 3.50/02/90F 3.2SN BK ...	Version	Product data	Packaging
Order No.	1719980000	PCB plug-in connector, male header, Flange, THT solder connection,	IEC: / 17 A	Box
GTIN (EAN)	4008190354268	3.50 mm, Number of poles: 2, 90°, Solder pin length (l): 3.2 mm,	UL: 300 V / 10 A	
Qty.	100 pc(s).	tinned, black, Box		
Type	SL 3.50/02/90F 4.5 SN O ...	Version	Product data	Packaging
Order No.	1618060000	PCB plug-in connector, male header, Flange, THT solder connection,	IEC: / 17 A	Box
GTIN (EAN)	4008190116132	3.50 mm, Number of poles: 2, 90°, Solder pin length (l): 4.5 mm,	UL: 300 V / 10 A	
Qty.	100 pc(s).	tinned, orange, Box		
Type	SL 3.50/02/90F 4.5 SN B ...	Version	Product data	Packaging
Order No.	1615530000	PCB plug-in connector, male header, Flange, THT solder connection,	IEC: / 17 A	Box
GTIN (EAN)	4008190056551	3.50 mm, Number of poles: 2, 90°, Solder pin length (l): 4.5 mm,	UL: 300 V / 10 A	
Qty.	100 pc(s).	tinned, black, Box		

**OMNIMATE Signal - series BL/SL 3.50
BL 3.50/02/270 SN BK BX**

Weidmüller Interface GmbH & Co. KG
Klingenbergstraße 26
D-32758 Detmold
Germany
Fon: +49 5231 14-0
Fax: +49 5231 14-292083
www.weidmueller.com

Mating connector (conditionally pluggable)
SL-SMT 3.5/180LF Box

High-temperature-resistant male header, 3.50 mm pitch.

- **Plugging direction parallel (90°), straight 180° or angled (135°) to PCB**
- **Housing variants: closed side (G), screw flange (F), solder flange (LF) or snap-on solder flange (RF)**
- **Optimised for the SMT process**
- **Pin length 3.2 mm universal for all soldering methods**
- **Pin length 1.5 mm optimised for reflow soldering methods**
- **Packed either in a box (BX) or tape-on-reel (RL)**
- **Male header can be coded**

General ordering data

Type	SL-SMT 3.50/02/180LF 1. ...	Version	Product data	Packaging
Order No.	1804700000	PCB plug-in connector, male header, Solder flange, THT/THR solder connection, 3.50 mm, Number of poles: 2, 180°, Solder pin length (l): 1.5 mm, tinned, black, Box	IEC: 320 V / 15 A UL: 300 V / 10 A	Box
GTIN (EAN)	4032248268511			
Qty.	132 pc(s).			
Type	SL-SMT 3.50/02/180LF 3. ...	Version	Product data	Packaging
Order No.	1842540000	PCB plug-in connector, male header, Solder flange, THT/THR solder connection, 3.50 mm, Number of poles: 2, 180°, Solder pin length (l): 3.2 mm, tinned, black, Box	IEC: 320 V / 15 A UL: 300 V / 10 A	Box
GTIN (EAN)	4032248353903			
Qty.	132 pc(s).			

OMNIMATE Signal - series BL/SL 3.50
BL 3.50/02/270 SN BK BX

Weidmüller Interface GmbH & Co. KG
 Klingenbergstraße 26
 D-32758 Detmold
 Germany
 Fon: +49 5231 14-0
 Fax: +49 5231 14-292083
 www.weidmueller.com

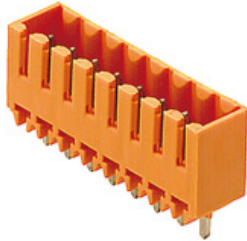
Mating connector (fully pluggable)**SL 3.50/180G**

Pin headers for wave soldering in 3.50 mm pitch

- Plugging direction is parallel (90°), straight 180° or angled (135°) to the PCB
- Housing variant: screw flange (F)
- Packed in a cardboard box (BX)
- Pin header can be coded

General ordering data

Type	SL 3.50/02/180G 4.5SN O ...	Version	Product data	Packaging
Order No.	1604620000	PCB plug-in connector, male header, closed side, THT solder	IEC: 320 V / 17 A	Box
GTIN (EAN)	4008190112547	connection, 3.50 mm, Number of poles: 2, 180°, Solder pin length (l):	UL: 300 V / 10 A	
Qty.	100 pc(s).	4.5 mm, tinned, orange, Box		
Type	SL 3.50/02/180G 3.2SN O ...	Version	Product data	Packaging
Order No.	1604470000	PCB plug-in connector, male header, closed side, THT solder	IEC: 320 V / 17 A	Box
GTIN (EAN)	4008190137526	connection, 3.50 mm, Number of poles: 2, 180°, Solder pin length (l):	UL: 300 V / 10 A	
Qty.	100 pc(s).	3.2 mm, tinned, orange, Box		
Type	SL 3.50/02/180G 4.5 SN ...	Version	Product data	Packaging
Order No.	1614240000	PCB plug-in connector, male header, closed side, THT solder	IEC: 320 V / 17 A	Box
GTIN (EAN)	4008190021276	connection, 3.50 mm, Number of poles: 2, 180°, Solder pin length (l):	UL: 300 V / 10 A	
Qty.	100 pc(s).	4.5 mm, tinned, black, Box		
Type	SL 3.50/02/180G 3.2SN D ...	Version	Product data	Packaging
Order No.	1607350000	PCB plug-in connector, male header, closed side, THT solder	IEC: 320 V / 17 A	Box
GTIN (EAN)	4008190131746	connection, 3.50 mm, Number of poles: 2, 180°, Solder pin length (l):	UL: 300 V / 10 A	
Qty.	100 pc(s).	3.2 mm, tinned, Signal green, Box		

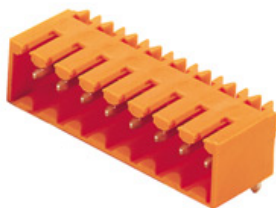
SL 3.50/90G

Pin headers for wave soldering in 3.50 mm pitch

- Plugging direction is parallel (90°), straight 180° or angled (135°) to the PCB
- Housing variant: screw flange (F)
- Packed in a cardboard box (BX)
- Pin header can be coded

General ordering data

Type	SL 3.50/02/90G 3.2SN OR ...	Version	Product data	Packaging
Order No.	1605070000	PCB plug-in connector, male header, closed side, THT solder	IEC: / 17 A	Box
GTIN (EAN)	4008190085100	connection, 3.50 mm, Number of poles: 2, 90°, Solder pin length (l):	UL: 300 V / 10 A	
Qty.	100 pc(s).	3.2 mm, tinned, orange, Box		
Type	SL 3.50/02/90G 4.5 SN B ...	Version	Product data	Packaging
Order No.	1614160000	PCB plug-in connector, male header, closed side, THT solder	IEC: / 17 A	Box
GTIN (EAN)	4008190020088	connection, 3.50 mm, Number of poles: 2, 90°, Solder pin length (l):	UL: 300 V / 10 A	
Qty.	100 pc(s).	4.5 mm, tinned, black, Box		

**OMNIMATE Signal - series BL/SL 3.50
BL 3.50/02/270 SN BK BX**

Weidmüller Interface GmbH & Co. KG
Klingenbergstraße 26
D-32758 Detmold
Germany
Fon: +49 5231 14-0
Fax: +49 5231 14-292083
www.weidmueller.com

Mating connector (fully pluggable)

Type	SL 3.50/02/90G 4.5SN OR ...	Version	Product data	Packaging
Order No.	1605220000	PCB plug-in connector, male header, closed side, THT solder	IEC: / 17 A	Box
GTIN (EAN)	4008190029456	connection, 3.50 mm, Number of poles: 2, 90°, Solder pin length (l):	UL: 300 V / 10 A	
Qty.	100 pc(s).	4.5 mm, tinned, orange, Box		
Type	SL 3.50/02/90G 3.2SN BK ...	Version	Product data	Packaging
Order No.	1683240000	PCB plug-in connector, male header, closed side, THT solder	IEC: / 17 A	Box
GTIN (EAN)	4008190475352	connection, 3.50 mm, Number of poles: 2, 90°, Solder pin length (l):	UL: 300 V / 10 A	
Qty.	100 pc(s).	3.2 mm, tinned, black, Box		
Type	SL 3.50/02/90G 3.2SN DK ...	Version	Product data	Packaging
Order No.	1606920000	PCB plug-in connector, male header, closed side, THT solder	IEC: / 17 A	Box
GTIN (EAN)	4008190044541	connection, 3.50 mm, Number of poles: 2, 90°, Solder pin length (l):	UL: 300 V / 10 A	
Qty.	100 pc(s).	3.2 mm, tinned, Signal green, Box		
Type	SL 3.50/02/90G 3.2SN GY ...	Version	Product data	Packaging
Order No.	1619460000	PCB plug-in connector, male header, closed side, THT solder	IEC: / 17 A	Box
GTIN (EAN)	4008190140328	connection, 3.50 mm, Number of poles: 2, 90°, Solder pin length (l):	UL: 300 V / 10 A	
Qty.	100 pc(s).	3.2 mm, tinned, Pebble grey, Box		

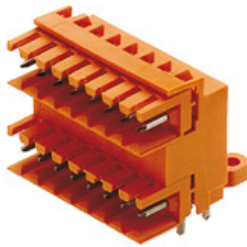
SLD 3.50/90

Two-tier pin header for wave soldering in 3.50 mm pitch. The connector is available in open, closed and flange versions. The male connectors provide space for labelling and can be coded. Packed in a cardboard box.

General ordering data

Type	SLD 3.50/04/90 3.2SN OR ...	Version	Product data	Packaging
Order No.	1633350000	PCB plug-in connector, male header, open side, THT solder	IEC: 200 V / 10.5 A	Box
GTIN (EAN)	4008190257804	connection, 3.50 mm, Number of poles: 4, 90°, Solder pin length (l):	UL: 300 V / 8 A	
Qty.	50 pc(s).	3.2 mm, tinned, orange, Box		

**OMNIMATE Signal - series BL/SL 3.50
BL 3.50/02/270 SN BK BX**

Weidmüller Interface GmbH & Co. KG
Klingenbergstraße 26
D-32758 Detmold
Germany
Fon: +49 5231 14-0
Fax: +49 5231 14-292083
www.weidmueller.com

Mating connector (fully pluggable)
SL-SMT 3.5/90G Tray

High-temperature-resistant male header, 3.50 mm pitch.

- **Plugging direction parallel (90°), straight 180° or angled (135°) to PCB**
- **Housing variants: closed side (G), screw flange (F), solder flange (LF) or snap-on solder flange (RF)**
- **Optimised for the SMT process**
- **Pin length 3.2 mm universal for all soldering methods**
- **Pin length 1.5 mm optimised for reflow soldering methods**
- **Packed either in a box (BX) or tape-on-reel (RL)**
- **Male header can be coded**

General ordering data

Type	SL-SMT 3.50/02/90G 1.5S ...	Version	Product data	Packaging
Order No.	1761543001	PCB plug-in connector, male header, closed side, THT/THR solder connection, 3.50 mm, Number of poles: 2, 90°, Solder pin length (l): 1.5 mm, tinned, black, Tray	IEC: 320 V / 15 A UL: 300 V / 10 A	Tray
GTIN (EAN)	4032248133819			
Qty.	108 pc(s).			

SL-SMT 3.5/90G Tape

High-temperature-resistant male header, 3.50 mm pitch.

- **Plugging direction parallel (90°), straight 180° or angled (135°) to PCB**
- **Housing variants: closed side (G), screw flange (F), solder flange (LF) or snap-on solder flange (RF)**
- **Optimised for the SMT process**
- **Pin length 3.2 mm universal for all soldering methods**
- **Pin length 1.5 mm optimised for reflow soldering methods**
- **Packed either in a box (BX) or tape-on-reel (RL)**
- **Male header can be coded**

General ordering data

Type	SL-SMT 3.50/02/90G 1.5S ...	Version	Product data	Packaging
Order No.	1761544001	PCB plug-in connector, male header, closed side, THT/THR solder connection, 3.50 mm, Number of poles: 2, 90°, Solder pin length (l): 1.5 mm, tinned, black, Tape	IEC: 320 V / 15 A UL: 300 V / 10 A	Tape
GTIN (EAN)	4032248135882			
Qty.	385 pc(s).			

OMNIMATE Signal - series BL/SL 3.50 BL 3.50/02/270 SN BK BX

Weidmüller Interface GmbH & Co. KG
Klingenbergstraße 26
D-32758 Detmold
Germany
Fon: +49 5231 14-0
Fax: +49 5231 14-292083
www.weidmueller.com

Mating connector (fully pluggable)

Type	SL-SMT 3.50/02/90G 1.5S ...	Version	Product data	Packaging
Order No.	1761544002	PCB plug-in connector, male header, closed side, THT/THR solder	IEC: 320 V / 15 A	Tape
GTIN (EAN)	4032248193325	connection, 3.50 mm, Number of poles: 2, 90°, Solder pin length (l):	UL: 300 V / 10 A	
Qty.	385 pc(s).	1.5 mm, tinned, black, Tape		

SL-THR 3.5/135F



High-temperature-resistant male header, 3.50 mm pitch.

- **Plugging direction parallel (90°), straight 180° or angled (135°) to PCB**
- **Housing variants: closed side (G), screw flange (F), solder flange (LF) or snap-on solder flange (RF)**
- **Optimised for the SMT process**
- **Pin length 3.2 mm universal for all soldering methods**
- **Pin length 1.5 mm optimised for reflow soldering methods**
- **Packed either in a box (BX) or tape-on-reel (RL)**
- **Male header can be coded**

General ordering data

Type	SL-SMT 3.50/02/135F 3.2 ...	Version	Product data	Packaging
Order No.	1003510000	PCB plug-in connector, male header, Flange, THT/THR solder	IEC: 320 V / 15 A	Box
GTIN (EAN)	4032248700141	connection, 3.50 mm, Number of poles: 2, 135°, Solder pin length (l):	UL: 300 V / 10 A	
Qty.	132 pc(s).	3.2 mm, tinned, black, Box		

SLD 3.50V/90G



Double-level, staggered pin header for wave soldering at 3.50 mm pitch. They are available in closed and flanged versions. The male connectors provide space for labelling and can be coded.

General ordering data

Type	SLD 3.50V/04/90G 3.2SN ...	Version	Product data	Packaging
Order No.	1642240000	PCB plug-in connector, male header, closed side, THT solder	IEC: 200 V / 10.5 A	Box
GTIN (EAN)	4008190280758	connection, 3.50 mm, Number of poles: 4, 90°, Solder pin length (l):	UL: 300 V / 8 A	
Qty.	50 pc(s).	3.2 mm, tinned, orange, Box		

**OMNIMATE Signal - series BL/SL 3.50
BL 3.50/02/270 SN BK BX**

Weidmüller Interface GmbH & Co. KG
Klingenbergstraße 26
D-32758 Detmold
Germany
Fon: +49 5231 14-0
Fax: +49 5231 14-292083
www.weidmueller.com

Mating connector (fully pluggable)
SL-SMT 3.5/180G Tape

High-temperature-resistant male header, 3.50 mm pitch.

- **Plugging direction parallel (90°), straight 180° or angled (135°) to PCB**
- **Housing variants: closed side (G), screw flange (F), solder flange (LF) or snap-on solder flange (RF)**
- **Optimised for the SMT process**
- **Pin length 3.2 mm universal for all soldering methods**
- **Pin length 1.5 mm optimised for reflow soldering methods**
- **Packed either in a box (BX) or tape-on-reel (RL)**
- **Male header can be coded**

General ordering data

Type	SL-SMT 3.50/02/180G 1.5 ...	Version	Product data	Packaging
Order No.	1752984002	PCB plug-in connector, male header, closed side, THT/THR solder	IEC: 320 V / 15 A	Tape
GTIN (EAN)	4032248193097	connection, 3.50 mm, Number of poles: 2, 180°, Solder pin length (l):	UL: 300 V / 10 A	
Qty.	265 pc(s).	1.5 mm, tinned, black, Tape		

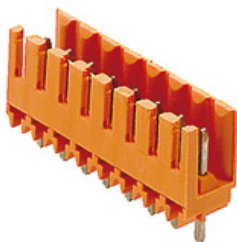
SL 3.50/180

Pin headers for wave soldering in 3.50 mm pitch

- **Plugging direction is parallel (90°), straight 180° or angled (135°) to the PCB**
- **Housing variant: screw flange (F)**
- **Packed in a cardboard box (BX)**
- **Pin header can be coded**

General ordering data

Type	SL 3.50/02/180 3.2SN OR ...	Version	Product data	Packaging
Order No.	1604770000	PCB plug-in connector, male header, open side, THT solder	IEC: 320 V / 17 A	Box
GTIN (EAN)	4008190054182	connection, 3.50 mm, Number of poles: 2, 180°, Solder pin length (l):	UL: 300 V / 10 A	
Qty.	100 pc(s).	3.2 mm, tinned, orange, Box		

OMNIMATE Signal - series BL/SL 3.50 BL 3.50/02/270 SN BK BX

Weidmüller Interface GmbH & Co. KG
 Klingenbergstraße 26
 D-32758 Detmold
 Germany
 Fon: +49 5231 14-0
 Fax: +49 5231 14-292083
 www.weidmueller.com

Mating connector (fully pluggable)

SL-SMT 3.5/180G Tray



High-temperature-resistant male header, 3.50 mm pitch.

- **Plugging direction parallel (90°), straight 180° or angled (135°) to PCB**
- **Housing variants: closed side (G), screw flange (F), solder flange (LF) or snap-on solder flange (RF)**
- **Optimised for the SMT process**
- **Pin length 3.2 mm universal for all soldering methods**
- **Pin length 1.5 mm optimised for reflow soldering methods**
- **Packed either in a box (BX) or tape-on-reel (RL)**
- **Male header can be coded**

General ordering data

Type	SL-SMT 3.50/02/180G 1.5 ...	Version	Product data	Packaging
Order No.	1752983001	PCB plug-in connector, male header, closed side, THT/THR solder connection, 3.50 mm, Number of poles: 2, 180°, Solder pin length (l): 1.5 mm, tinned, black, Tray	IEC: 320 V / 15 A UL: 300 V / 10 A	Tray
GTIN (EAN)	4032248132713			
Qty.	108 pc(s).			

SL-SMT 3.5/90G Box



High-temperature-resistant male header, 3.50 mm pitch.

- **Plugging direction parallel (90°), straight 180° or angled (135°) to PCB**
- **Housing variants: closed side (G), screw flange (F), solder flange (LF) or snap-on solder flange (RF)**
- **Optimised for the SMT process**
- **Pin length 3.2 mm universal for all soldering methods**
- **Pin length 1.5 mm optimised for reflow soldering methods**
- **Packed either in a box (BX) or tape-on-reel (RL)**
- **Male header can be coded**

General ordering data

Type	SL-SMT 3.50/02/90G 1.5S ...	Version	Product data	Packaging
Order No.	1761542001	PCB plug-in connector, male header, closed side, THT/THR solder connection, 3.50 mm, Number of poles: 2, 90°, Solder pin length (l): 1.5 mm, tinned, black, Box	IEC: 320 V / 15 A UL: 300 V / 10 A	Box
GTIN (EAN)	4032248132034			
Qty.	100 pc(s).			

**OMNIMATE Signal - series BL/SL 3.50
BL 3.50/02/270 SN BK BX**

Weidmüller Interface GmbH & Co. KG
Klingenbergstraße 26
D-32758 Detmold
Germany
Fon: +49 5231 14-0
Fax: +49 5231 14-292083
www.weidmueller.com

Mating connector (fully pluggable)

Type	SL-SMT 3.50/02/90G 3.2S ...	Version	Product data	Packaging
Order No.	1841630000	PCB plug-in connector, male header, closed side, THT/THR solder	IEC: 320 V / 15 A	Box
GTIN (EAN)	4032248352784	connection, 3.50 mm, Number of poles: 2, 90°, Solder pin length (l):	UL: 300 V / 10 A	
Qty.	100 pc(s).	3.2 mm, tinned, black, Box		

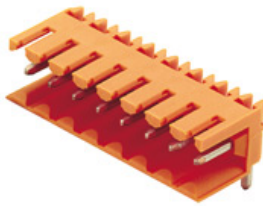
SL 3.50/90

Pin headers for wave soldering in 3.50 mm pitch

- Plugging direction is parallel (90°), straight 180° or angled (135°) to the PCB
- Housing variant: screw flange (F)
- Packed in a cardboard box (BX)
- Pin header can be coded

General ordering data

Type	SL 3.50/02/90 4.5 SN BK ...	Version	Product data	Packaging
Order No.	1614130000	PCB plug-in connector, male header, open side, THT solder	IEC: 320 V / 17 A	Box
GTIN (EAN)	4008190019600	connection, 3.50 mm, Number of poles: 2, 90°, Solder pin length (l):	UL: 300 V / 10 A	
Qty.	100 pc(s).	4.5 mm, tinned, black, Box		
Type	SL 3.50/02/90 3.2SN DKG ...	Version	Product data	Packaging
Order No.	1606800000	PCB plug-in connector, male header, open side, THT solder	IEC: 320 V / 17 A	Box
GTIN (EAN)	4008190046088	connection, 3.50 mm, Number of poles: 2, 90°, Solder pin length (l):	UL: 300 V / 10 A	
Qty.	100 pc(s).	3.2 mm, tinned, Signal green, Box		
Type	SL 3.50/02/90 3.2SN OR ...	Version	Product data	Packaging
Order No.	1597210000	PCB plug-in connector, male header, open side, THT solder	IEC: 320 V / 17 A	Box
GTIN (EAN)	4008190175320	connection, 3.50 mm, Number of poles: 2, 90°, Solder pin length (l):	UL: 300 V / 10 A	
Qty.	100 pc(s).	3.2 mm, tinned, orange, Box		
Type	SL 3.50/02/90 4.5SN OR ...	Version	Product data	Packaging
Order No.	1605370000	PCB plug-in connector, male header, open side, THT solder	IEC: 320 V / 17 A	Box
GTIN (EAN)	4008190161071	connection, 3.50 mm, Number of poles: 2, 90°, Solder pin length (l):	UL: 300 V / 10 A	
Qty.	100 pc(s).	4.5 mm, tinned, orange, Box		
Type	SL 3.50/02/90 3.2SN GY ...	Version	Product data	Packaging
Order No.	1619070000	PCB plug-in connector, male header, open side, THT solder	IEC: 320 V / 17 A	Box
GTIN (EAN)	4008190133498	connection, 3.50 mm, Number of poles: 2, 90°, Solder pin length (l):	UL: 300 V / 10 A	
Qty.	100 pc(s).	3.2 mm, tinned, Pebble grey, Box		

**OMNIMATE Signal - series BL/SL 3.50
BL 3.50/02/270 SN BK BX**

Weidmüller Interface GmbH & Co. KG
Klingenbergstraße 26
D-32758 Detmold
Germany
Fon: +49 5231 14-0
Fax: +49 5231 14-292083
www.weidmueller.com

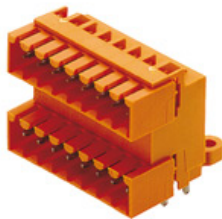
Mating connector (fully pluggable)
SLD 3.50/90G

Two-tier pin header for wave soldering in 3.50 mm pitch. The connector is available in open, closed and flange versions. The male connectors provide space for labelling and can be coded. Packed in a cardboard box.

General ordering data

Type	SLD 3.50/04/90G 4.5SN B ...	Version	Product data	Packaging
Order No.	1634270000	PCB plug-in connector, male header, closed side, THT solder connection, 3.50 mm, Number of poles: 4, 90°, Solder pin length (l): 4.5 mm, tinned, black, Box	IEC: 200 V / 10.5 A UL: 300 V / 8 A	Box
GTIN (EAN)	4008190258726			
Qty.	50 pc(s).			
Type	SLD 3.50/04/90G 3.2SN O ...	Version	Product data	Packaging
Order No.	1633580000	PCB plug-in connector, male header, closed side, THT solder connection, 3.50 mm, Number of poles: 4, 90°, Solder pin length (l): 3.2 mm, tinned, orange, Box	IEC: 200 V / 10.5 A UL: 300 V / 8 A	Box
GTIN (EAN)	4008190258030			
Qty.	50 pc(s).			

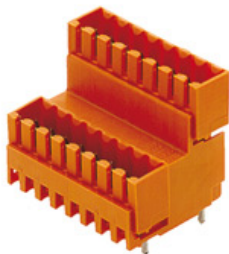
SLD 3.50V/180G

Double-level, staggered pin header for wave soldering at 3.50 mm pitch. They are available in closed and flanged versions. The male connectors provide space for labelling and can be coded.

General ordering data

Type	SLD 3.50V/04/180G 3.2SN ...	Version	Product data	Packaging
Order No.	1641110000	PCB plug-in connector, male header, closed side, THT solder connection, 3.50 mm, Number of poles: 4, 180°, Solder pin length (l): 3.2 mm, tinned, orange, Box	IEC: 200 V / 10.5 A UL: 300 V / 8 A	Box
GTIN (EAN)	4008190279516			
Qty.	50 pc(s).			

OMNIMATE Signal - series BL/SL 3.50 BL 3.50/02/270 SN BK BX

Weidmüller Interface GmbH & Co. KG
 Klingenbergstraße 26
 D-32758 Detmold
 Germany
 Fon: +49 5231 14-0
 Fax: +49 5231 14-292083
 www.weidmueller.com

Accessories

Coding elements



**Only connects what is supposed to be connected:
the right connection at the right place.**

Coding elements and locking devices clearly assign connecting elements during the manufacturing process and operation

The coding elements and locking devices are inserted prior to assembly or during the cable assembly phase. The Weidmüller alternative: configure online using the variant configurator to precode prior to delivery.

Incorrect assembly on the circuit board and incorrect plugging of connecting elements is no longer possible. The advantage: no troubleshooting during manufacture and no operational errors by the user.

General ordering data

Type	BL SL 3.5 KO SW	Version	Product data	Packaging
Order No.	1610100000	PCB plug-in connector, Accessories, Coding element, black, Number		Box
GTIN (EAN)	4008190187637	of poles: 1		
Qty.	100 pc(s).			
Type	BL SL 3.5 KO OR	Version	Product data	Packaging
Order No.	1693430000	PCB plug-in connector, Accessories, Coding element, orange, Number		Box
GTIN (EAN)	4008190867447	of poles: 1		
Qty.	100 pc(s).			

WEITERGABE SOWIE VERVIELFÄLTIGUNG DIESES DOKUMENTS, VERWERTUNG UND MITTEILUNG SEINES INHALTS SIND VERBOTEN, SOWEIT NICHT AUSDRUECKLICH GESTATTET.
 ZUWIDERHANDLUNGEN VERPFLICHTEN ZU SCHADENERSATZ. ALLE RECHTE FUER DEN FALL DER PATENT-, GEBRAUCHSMUSTER- ODER GESCHMACKSMUSTEREINTRAGUNG VORBEHALTEN.
 THE REPRODUCTION, DISTRIBUTION AND UTILIZATION OF THIS DOCUMENT AS WELL AS THE COMMUNICATION OF ITS CONTENTS TO OTHERS WITHOUT EXPLICIT AUTHORIZATION IS PROHIBITED.
 OFFENDERS WILL BE HELD LIABLE FOR THE PAYMENT OF DAMAGES. WEIDMUELLER EXCLUSIVELY RESERVES THE RIGHT TO FILE FOR PATENTS, UTILITY MODELS OR DESIGNS.

© WEIDMUELLER INTERFACE GmbH & Co.KG

DIE DEUTSCHE VERSION IST VERBINDLICH
 THE GERMAN VERSION IS BINDING

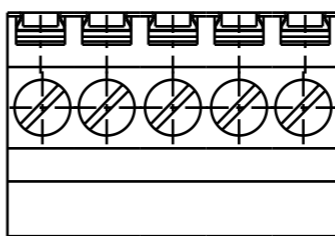
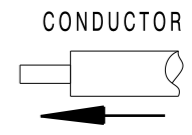
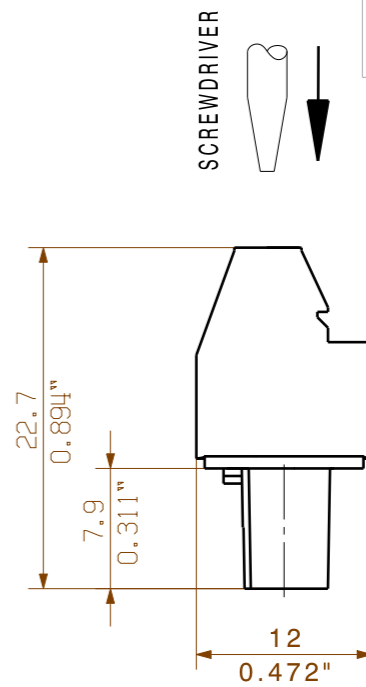
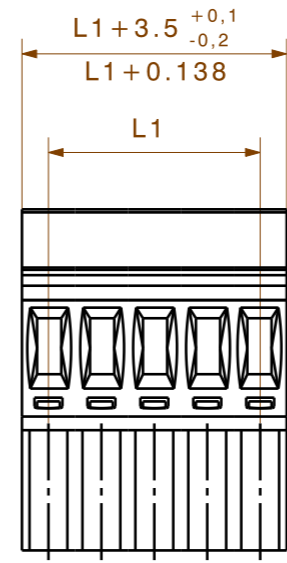

24	80,50	3,169
23	77,00	3,031
22	73,50	2,894
21	70,00	2,756
20	66,50	2,618
19	63,00	2,480
18	59,50	2,343
17	56,00	2,205
16	52,50	2,067
15	49,00	1,929
14	45,50	1,791
13	42,00	1,654
12	38,50	1,516
11	35,00	1,378
10	31,50	1,240
9	28,00	1,102
8	24,50	0,965
7	21,00	0,827
6	17,50	0,689
5	14,00	0,551
4	10,50	0,413
3	7,00	0,276
2	3,50	0,138
n	L1[mm]	L1 [Inch]

For the mounting of PCBs, it should be noted that the rated data stated here relates only to the PCB components alone.
 The necessary creepage and clearance paths must be observed in connection with the respective applicant in accordance to IEC 664 / VDE 0110.
 The current-carrying capacity and pitch tolerance is to be determined according to DIN IEC 326 part 3 very fine.

Weidmüller PCB components are tested to the DIN EN 61984 standard, and are valid for its field of application.
 Provided that the components are used to the intended purpose, all requirements with respect to the occurring of electrical, mechanical, thermic and corrosive stress will be satisfied.

SHOWN : BL3.50/05/270

	DIN ISO 2768-m		CAT.NO.: .	
	74368/5 15.04.14 HELIS_MA 01		C 21347 09 DRAWING NO. ISSUE NO.	
		MODIFICATION		SHEET 01 OF 02 SHEETS
		DATE 24.07.2003	NAME KOWOLLIK_R	BL 3.50/.../270... BUCHSENLEISTE SOCKET BLOCK
SCALE: 5/1		RESPONSIBLE THELEN_E	CHECKED 15.04.2014	
SUPERSEDES: .		APPROVED HECKERT_M	PRODUCT FILE: BL 3.50 90/270	
				7368