

OMNIMATE Signal - series BL/SL 3.50 BL 3.50/14/270 SN OR BX

Weidmüller Interface GmbH & Co. KG
Klingenbergstraße 26
D-32758 Detmold
Germany
Fon: +49 5231 14-0
Fax: +49 5231 14-292083
www.weidmueller.com

Product image

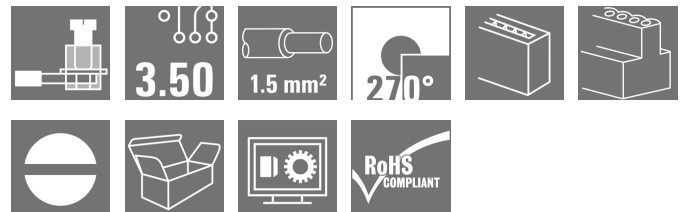

Similar to illustration

Female connectors with clamping yoke screw system for connecting conductors at 3.50 mm pitch. They provide space for labelling and can be coded.

General ordering data

Type	BL 3.50/14/270 SN OR BX
Order No.	1639590000
Version	PCB plug-in connector, female plug, 3.50 mm, Number of poles: 14, 270°, Clamping yoke connection, Clamping range, max. : 1.5 mm², Box
GTIN (EAN)	4008190277147
Qty.	36 pc(s).
Product data	IEC: 320 V / 12 A / 0.2 - 1.5 mm² UL: 300 V / 8 A / AWG 28 - AWG 14
Packaging	Box

Creation date May 3, 2020 5:32:05 PM CEST

OMNIMATE Signal - series BL/SL 3.50
BL 3.50/14/270 SN OR BX

Weidmüller Interface GmbH & Co. KG
 Klingenbergstraße 26
 D-32758 Detmold
 Germany
 Fon: +49 5231 14-0
 Fax: +49 5231 14-292083
 www.weidmueller.com

Technical data
Dimensions and weights

Width	49 mm	Width (inches)	1.929 inch
Height	12 mm	Height (inches)	0.472 inch
Depth	22.45 mm	Depth (inches)	0.884 inch
Net weight	13.82 g		

System Parameters

Product family	OMNIMATE Signal - series BL/SL 3.50	Type of connection	Field connection
Wire connection method	Clamping yoke connection	Pitch in mm (P)	3.5 mm
Pitch in inches (P)	0.138 inch	Conductor outlet direction	270°
Number of poles	14	L1 in mm	45.5 mm
L1 in inches	1.791 inch	Number of rows	1
Pin series quantity	1	Rated cross-section	1.5 mm ²
Touch-safe protection acc. to DIN VDE 57 106	Safe from finger touch	Touch-safe protection acc. to DIN VDE 0470	IP 20
Volume resistance	≤ 5mΩ	Can be coded	Yes
Stripping length	6 mm	Tightening torque, min.	0.2 Nm
Tightening torque, max.	0.25 Nm	Clamping screw	M 2
Screwdriver blade	0.4 x 2.5	Screwdriver blade standard	DIN 5264
Plugging cycles	25	Plugging force/pole, max.	7 N
Pulling force/pole, max.	5 N		

Material data

Insulating material	PBT	Colour	orange
Colour chart (similar)	RAL 2000	Insulating material group	IIIa
Comparative Tracking Index (CTI)	≥ 200	Insulation strength	≥ 10 ⁸ Ω
UL 94 flammability rating	V-0	GWFI	960 °C
Contact material	Copper alloy	Contact surface	tinned
Layer structure of plug contact	4-8 μm Sn hot-dip tinned	Storage temperature, min.	-25 °C
Storage temperature, max.	50 °C	Max. relative humidity during storage	70 %
Operating temperature, min.	-50 °C	Operating temperature, max.	100 °C
Temperature range, installation, min.	-30 °C	Temperature range, installation, max.	100 °C

Conductors suitable for connection

Clamping range, min.	0.08 mm ²
Clamping range, max.	1.5 mm ²
Wire connection cross section AWG, min.	AWG 28
Wire connection cross section AWG, max.	AWG 14
Solid, min. H05(07) V-U	0.2 mm ²
Solid, max. H05(07) V-U	1.5 mm ²
Flexible, min. H05(07) V-K	0.2 mm ²
Flexible, max. H05(07) V-K	1.5 mm ²
w. plastic collar ferrule, DIN 46228 pt 4, 0.2 mm ² min.	
w. plastic collar ferrule, DIN 46228 pt 4, 1.5 mm ² max.	
w. wire end ferrule, DIN 46228 pt 1, 0.2 mm ² min.	
w. wire end ferrule, DIN 46228 pt 1, 1.5 mm ² max.	

Creation date May 3, 2020 5:32:05 PM CEST

OMNIMATE Signal - series BL/SL 3.50
BL 3.50/14/270 SN OR BX

Weidmüller Interface GmbH & Co. KG
 Klingenbergstraße 26
 D-32758 Detmold
 Germany
 Fon: +49 5231 14-0
 Fax: +49 5231 14-292083
 www.weidmueller.com

Technical data

Plug gauge in accordance with EN 60999 a x b; ø 2.4 mm x 1.5 mm

Clampable conductor	Cross-section for conductor connection	Type	fine-wired
		nominal	0.5 mm ²
wire end ferrule		Stripping length	nominal 8 mm
		Recommended wire-end ferrule	H0.5/12 OR
		Stripping length	nominal 6 mm
		Recommended wire-end ferrule	H0.5/6
Cross-section for conductor connection	Type	fine-wired	
	nominal	0.75 mm ²	
wire end ferrule		Stripping length	nominal 8 mm
		Recommended wire-end ferrule	H0.75/12 W
		Stripping length	nominal 6 mm
		Recommended wire-end ferrule	H0.75/6
Cross-section for conductor connection	Type	fine-wired	
	nominal	1 mm ²	
wire end ferrule		Stripping length	nominal 8 mm
		Recommended wire-end ferrule	H1.0/12 GE
		Stripping length	nominal 6 mm
		Recommended wire-end ferrule	H1.0/6
Cross-section for conductor connection	Type	fine-wired	
	nominal	0.25 mm ²	
wire end ferrule		Stripping length	nominal 8 mm
		Recommended wire-end ferrule	H0.25/10 HBL
		Stripping length	nominal 5 mm
		Recommended wire-end ferrule	H0.25/5
Cross-section for conductor connection	Type	fine-wired	
	nominal	0.34 mm ²	
wire end ferrule		Stripping length	nominal 8 mm
		Recommended wire-end ferrule	H0.34/10 TK

Reference text The outside diameter of the plastic collar should not be larger than the pitch (P). Length of ferrules is to be chosen depending on the product and the rated voltage.

Max. clamping range 1.5 mm²

Rated data acc. to IEC

tested acc. to standard	IEC 60664-1, IEC 61984	Rated current, min. number of poles (Tu=20°C)	12 A
Rated current, max. number of poles (Tu=20°C)	10 A	Rated current, min. number of poles (Tu=40°C)	10 A
Rated current, max. number of poles (Tu=40°C)	8 A	Rated voltage for surge voltage class / pollution degree II/2	320 V
Rated voltage for surge voltage class / pollution degree III/2	160 V	Rated voltage for surge voltage class / pollution degree III/3	160 V
Rated impulse voltage for surge voltage class/ pollution degree II/2	2.5 kV	Rated impulse voltage for surge voltage class/ pollution degree III/2	2.5 kV
Rated impulse voltage for surge voltage class/ contamination degree III/3	2.5 kV	Short-time withstand current resistance	3 x 1s with 100 A

**OMNIMATE Signal - series BL/SL 3.50
BL 3.50/14/270 SN OR BX**

Weidmüller Interface GmbH & Co. KG
Klingenbergstraße 26
D-32758 Detmold
Germany
Fon: +49 5231 14-0
Fax: +49 5231 14-292083
www.weidmueller.com

Technical data

Rated data acc. to CSA

Institute (CSA)				Certificate No. (CSA)	
				154685-1318353	
Rated voltage (Use group B / CSA)	300 V	Rated voltage (Use group D / CSA)	300 V		
Rated current (Use group B / CSA)	10 A	Rated current (Use group D / CSA)	10 A		
Wire cross-section, AWG, min.	AWG 28	Wire cross-section, AWG, max.	AWG 14		
Reference to approval values	Specifications are maximum values, details - see approval certificate.				

Rated data acc. to UL 1059

Institute (UR)				Certificate No. (UR)	
				E60693	
Rated voltage (Use group B / UL 1059)	300 V	Rated voltage (Use group D / UL 1059)	300 V		
Rated current (Use group B / UL 1059)	8 A	Rated current (Use group D / UL 1059)	8 A		
Wire cross-section, AWG, min.	AWG 28	Wire cross-section, AWG, max.	AWG 14		
Reference to approval values	Specifications are maximum values, details - see approval certificate.				

Packing

Packaging	Box	VPE length	65 mm
VPE width	103 mm	VPE height	130 mm

Classifications

ETIM 6.0	EC002638	ETIM 7.0	EC002638
eClass 9.0	27-44-03-09	eClass 9.1	27-44-03-09
eClass 10.0	27-44-03-09	UNSPSC	30-21-18-10

Data sheet

**OMNIMATE Signal - series BL/SL 3.50
BL 3.50/14/270 SN OR BX**

Weidmüller Interface GmbH & Co. KG
Klingenbergstraße 26
D-32758 Detmold
Germany
Fon: +49 5231 14-0
Fax: +49 5231 14-292083
www.weidmueller.com

Technical data

Notes

Notes	<ul style="list-style-type: none"> • Additional colours on request • Gold-plated contact surfaces on request • Rated current related to rated cross-section & min. No. of poles. • Max. outer diameter of the conductor: 2.9 mm • Wire end ferrule without plastic collar to DIN 46228/1 • Wire end ferrule with plastic collar to DIN 46228/4 • P on drawing = pitch • Rated data refer only to the component itself. Clearance and creepage distances to other components are to be designed in accordance with the relevant application standards.
IPC conformity	Conformity: The products are developed, manufactured and delivered according international recognized standards and norms and comply with the assured properties in the data sheet resp. fulfill decorative properties in accordance with IPC-A-610 "Class 2". Further claims on the products can be evaluated on request.

Approvals

Approvals



ROHS Conform

Downloads

Approval/Certificate/Document of Conformity	Declaration of the Manufacturer
Brochure/Catalogue	FL DRIVES EN MB DEVICE MANUF. EN FL DRIVES DE CAT 2 PORTFOLIOGUIDE EN FL BUILDING SAFETY EN FL APPL LED LIGHTING EN FLIndustr.CONTROLS EN FL MACHINE SAFETY EN FL HEATING ELECTRN EN FL APPL INVERTER EN FL_BASE_STATION EN FL ELEVATOR EN FL POWER SUPPLY EN FL 72H SAMPLE SER EN PO OMNIMATE EN
Engineering Data	EPLAN.WSCAD
Engineering Data	STEP

**OMNIMATE Signal - series BL/SL 3.50
BL 3.50/14/270 SN OR BX**

Weidmüller Interface GmbH & Co. KG
Klingenbergstraße 26
D-32758 Detmold
Germany
Fon: +49 5231 14-0
Fax: +49 5231 14-292083
www.weidmueller.com

Drawings

Dimensional drawing

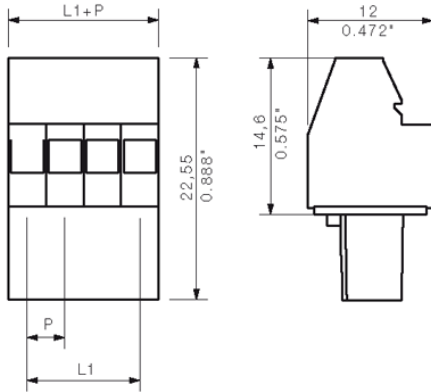

Graph

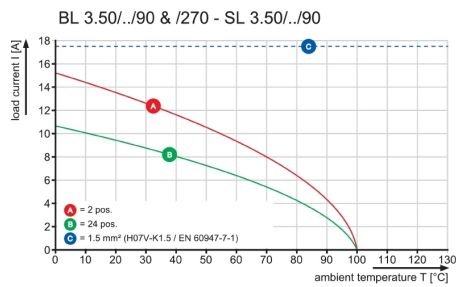

Graph

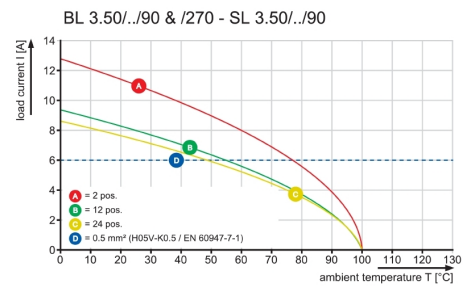

**OMNIMATE Signal - series BL/SL 3.50
BL 3.50/14/270 SN OR BX**

Weidmüller Interface GmbH & Co. KG
 Klingenbergstraße 26
 D-32758 Detmold
 Germany
 Fon: +49 5231 14-0
 Fax: +49 5231 14-292083
 www.weidmueller.com

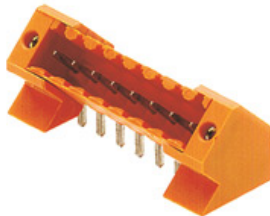
Mating connector (conditionally pluggable)
SL 3.50/135F

Pin headers for wave soldering in 3.50 mm pitch

- Plugging direction is parallel (90°), straight 180° or angled (135°) to the PCB
- Housing variant: screw flange (F)
- Packed in a cardboard box (BX)
- Pin header can be coded

General ordering data

Type	SL 3.50/14/135F 3.2SN O ...	Version	Product data	Packaging
Order No.	1643450000	PCB plug-in connector, male header, Flange, THT solder connection,	IEC: 320 V / 15 A	Box
GTIN (EAN)	4008190282219	3.50 mm, Number of poles: 14, 135°, Solder pin length (l): 3.2 mm,	UL: 300 V / 10 A	
Qty.	30 pc(s).	tinned, orange, Box		

SLD 3.50V/180F

Double-level, staggered pin header for wave soldering at 3.50 mm pitch. They are available in closed and flanged versions. The male connectors provide space for labelling and can be coded.

General ordering data

Type	SLD 3.50 V/28/180F 3.2 ...	Version	Product data	Packaging
Order No.	1641300000	PCB plug-in connector, male header, Flange, THT solder connection,	IEC: 200 V / 10.5 A	Box
GTIN (EAN)	4008190279707	3.50 mm, Number of poles: 28, 180°, Solder pin length (l): 3.2 mm,	UL: 300 V / 8 A	
Qty.	10 pc(s).	tinned, orange, Box		

**OMNIMATE Signal - series BL/SL 3.50
BL 3.50/14/270 SN OR BX**

Weidmüller Interface GmbH & Co. KG
 Klingenbergstraße 26
 D-32758 Detmold
 Germany
 Fon: +49 5231 14-0
 Fax: +49 5231 14-292083
 www.weidmueller.com

Mating connector (conditionally pluggable)**SL-SMT 3.5/90LF Box**

High-temperature-resistant male header, 3.50 mm pitch.

- **Plugging direction parallel (90°), straight 180° or angled (135°) to PCB**
- **Housing variants: closed side (G), screw flange (F), solder flange (LF) or snap-on solder flange (RF)**
- **Optimised for the SMT process**
- **Pin length 3.2 mm universal for all soldering methods**
- **Pin length 1.5 mm optimised for reflow soldering methods**
- **Packed either in a box (BX) or tape-on-reel (RL)**
- **Male header can be coded**

General ordering data

Type	SL-SMT 3.50/14/90LF 1.5 ...	Version	Product data	Packaging
Order No.	1805060000	PCB plug-in connector, male header, Solder flange, THT/THR solder	IEC: 320 V / 15 A	Box
GTIN (EAN)	4032248268962	connection, 3.50 mm, Number of poles: 14, 90°, Solder pin length (l):	UL: 300 V / 10 A	
Qty.	50 pc(s).	1.5 mm, tinned, black, Box		
Type	SL-SMT 3.50/14/90LF 3.2 ...	Version	Product data	Packaging
Order No.	1841970000	PCB plug-in connector, male header, Solder flange, THT/THR solder	IEC: 320 V / 15 A	Box
GTIN (EAN)	4032248353323	connection, 3.50 mm, Number of poles: 14, 90°, Solder pin length (l):	UL: 300 V / 10 A	
Qty.	30 pc(s).	3.2 mm, tinned, black, Box		

SL-SMT 3.5/180F Box

High-temperature-resistant male header, 3.50 mm pitch.

- **Plugging direction parallel (90°), straight 180° or angled (135°) to PCB**
- **Housing variants: closed side (G), screw flange (F), solder flange (LF) or snap-on solder flange (RF)**
- **Optimised for the SMT process**
- **Pin length 3.2 mm universal for all soldering methods**
- **Pin length 1.5 mm optimised for reflow soldering methods**
- **Packed either in a box (BX) or tape-on-reel (RL)**
- **Male header can be coded**

General ordering data

Type	SL-SMT 3.50/14/180F 1.5 ...	Version	Product data	Packaging
Order No.	1761082001	PCB plug-in connector, male header, Flange, THT/THR solder	IEC: 320 V / 15 A	Box
GTIN (EAN)	4032248131655	connection, 3.50 mm, Number of poles: 14, 180°, Solder pin length	UL: 300 V / 10 A	
Qty.	50 pc(s).	(l): 1.5 mm, tinned, black, Box		

Creation date May 3, 2020 5:32:06 PM CEST

**OMNIMATE Signal - series BL/SL 3.50
BL 3.50/14/270 SN OR BX**

Weidmüller Interface GmbH & Co. KG
Klingenbergstraße 26
D-32758 Detmold
Germany
Fon: +49 5231 14-0
Fax: +49 5231 14-292083
www.weidmuller.com

Mating connector (conditionally pluggable)

Type	SL-SMT 3.50/14/180F 3.2 ...	Version	Product data	Packaging
Order No.	1842890000	PCB plug-in connector, male header, Flange, THT/THR solder connection, 3.50 mm, Number of poles: 14, 180°, Solder pin length (l): 3.2 mm, tinned, black, Box	IEC: 320 V / 15 A UL: 300 V / 10 A	Box
GTIN (EAN)	4032248354351			
Qty.	30 pc(s).			

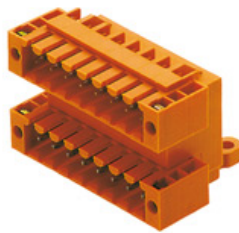
SLD 3.50/90F

Two-tier pin header for wave soldering in 3.50 mm pitch. The connector is available in open, closed and flange versions. The male connectors provide space for labelling and can be coded. Packed in a cardboard box.

General ordering data

Type	SLD 3.50/28/90F 3.2SN O ...	Version	Product data	Packaging
Order No.	1633930000	PCB plug-in connector, male header, Flange, THT solder connection, 3.50 mm, Number of poles: 28, 90°, Solder pin length (l): 3.2 mm, tinned, orange, Box	IEC: 200 V / 10.5 A UL: 300 V / 8 A	Box
GTIN (EAN)	4008190258382			
Qty.	10 pc(s).			

SLD 3.50V/90F

Double-level, staggered pin header for wave soldering at 3.50 mm pitch. They are available in closed and flanged versions. The male connectors provide space for labelling and can be coded.

General ordering data

Type	SLD 3.50 V/28/90F 3.2 S ...	Version	Product data	Packaging
Order No.	1642430000	PCB plug-in connector, male header, Flange, THT solder connection, 3.50 mm, Number of poles: 28, 90°, Solder pin length (l): 3.2 mm, tinned, orange, Box	IEC: 200 V / 10.5 A UL: 300 V / 8 A	Box
GTIN (EAN)	4008190280956			
Qty.	10 pc(s).			

**OMNIMATE Signal - series BL/SL 3.50
BL 3.50/14/270 SN OR BX**

Weidmüller Interface GmbH & Co. KG
Klingenbergstraße 26
D-32758 Detmold
Germany
Fon: +49 5231 14-0
Fax: +49 5231 14-292083
www.weidmueller.com

Mating connector (conditionally pluggable)**SL-SMT 3.5/180G Box**

High-temperature-resistant male header, 3.50 mm pitch.

- **Plugging direction parallel (90°), straight 180° or angled (135°) to PCB**
- **Housing variants: closed side (G), screw flange (F), solder flange (LF) or snap-on solder flange (RF)**
- **Optimised for the SMT process**
- **Pin length 3.2 mm universal for all soldering methods**
- **Pin length 1.5 mm optimised for reflow soldering methods**
- **Packed either in a box (BX) or tape-on-reel (RL)**
- **Male header can be coded**

General ordering data

Type	SL-SMT 3.50/14/180G 1.5 ...	Version	Product data	Packaging
Order No.	1753102001	PCB plug-in connector, male header, closed side, THT/THR solder connection, 3.50 mm, Number of poles: 14, 180°, Solder pin length (l): 1.5 mm, tinned, black, Box	IEC: 320 V / 15 A UL: 300 V / 10 A	Box
GTIN (EAN)	4032248131006			
Qty.	50 pc(s).			
Type	SL-SMT 3.50/14/180G 3.2 ...	Version	Product data	Packaging
Order No.	1842430000	PCB plug-in connector, male header, closed side, THT/THR solder connection, 3.50 mm, Number of poles: 14, 180°, Solder pin length (l): 3.2 mm, tinned, black, Box	IEC: 320 V / 15 A UL: 300 V / 10 A	Box
GTIN (EAN)	4032248353781			
Qty.	50 pc(s).			

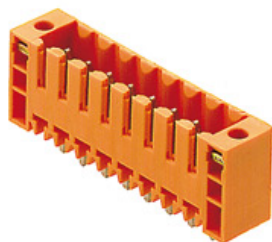
SL 3.50/180F

Pin headers for wave soldering in 3.50 mm pitch

- **Plugging direction is parallel (90°), straight 180° or angled (135°) to the PCB**
- **Housing variant: screw flange (F)**
- **Packed in a cardboard box (BX)**
- **Pin header can be coded**

General ordering data

Type	SL 3.50/14/180F 3.2SN O ...	Version	Product data	Packaging
Order No.	1607620000	PCB plug-in connector, male header, Flange, THT solder connection, 3.50 mm, Number of poles: 14, 180°, Solder pin length (l): 3.2 mm, tinned, orange, Box	IEC: 320 V / 17 A UL: 300 V / 10 A	Box
GTIN (EAN)	4008190055196			
Qty.	50 pc(s).			
Type	SL 3.50/14/180F 3.2SN D ...	Version	Product data	Packaging
Order No.	1622600000	PCB plug-in connector, male header, Flange, THT solder connection, 3.50 mm, Number of poles: 14, 180°, Solder pin length (l): 3.2 mm, tinned, Signal green, Box	IEC: 320 V / 17 A UL: 300 V / 10 A	Box
GTIN (EAN)	4008190193263			
Qty.	50 pc(s).			

OMNIMATE Signal - series BL/SL 3.50 BL 3.50/14/270 SN OR BX

Weidmüller Interface GmbH & Co. KG
Klingenbergstraße 26
D-32758 Detmold
Germany
Fon: +49 5231 14-0
Fax: +49 5231 14-292083
www.weidmueller.com

Mating connector (conditionally pluggable)

Type	SL 3.50/14/180F 3.2SN G ...	Version	Product data	Packaging
Order No.	1622380000	PCB plug-in connector, male header, Flange, THT solder connection,	IEC: 320 V / 17 A	Box
GTIN (EAN)	4008190190088	3.50 mm, Number of poles: 14, 180°, Solder pin length (l): 3.2 mm,	UL: 300 V / 10 A	
Qty.	50 pc(s).	tinned, Pebble grey, Box		
Type	SL 3.50/14/180F 4.5SN O ...	Version	Product data	Packaging
Order No.	1618800000	PCB plug-in connector, male header, Flange, THT solder connection,	IEC: 320 V / 17 A	Box
GTIN (EAN)	4008190127909	3.50 mm, Number of poles: 14, 180°, Solder pin length (l): 4.5 mm,	UL: 300 V / 10 A	
Qty.	50 pc(s).	tinned, orange, Box		
Type	SL 3.50/14/180F 4.5 SN ...	Version	Product data	Packaging
Order No.	1616250000	PCB plug-in connector, male header, Flange, THT solder connection,	IEC: 320 V / 17 A	Box
GTIN (EAN)	4008190069490	3.50 mm, Number of poles: 14, 180°, Solder pin length (l): 4.5 mm,	UL: 300 V / 10 A	
Qty.	50 pc(s).	tinned, black, Box		

SL-SMT 3.5/90F Box



High-temperature-resistant male header, 3.50 mm pitch.

- **Plugging direction parallel (90°), straight 180° or angled (135°) to PCB**
- **Housing variants: closed side (G), screw flange (F), solder flange (LF) or snap-on solder flange (RF)**
- **Optimised for the SMT process**
- **Pin length 3.2 mm universal for all soldering methods**
- **Pin length 1.5 mm optimised for reflow soldering methods**
- **Packed either in a box (BX) or tape-on-reel (RL)**
- **Male header can be coded**

General ordering data

Type	SL-SMT 3.50/14/90F 3.2S ...	Version	Product data	Packaging
Order No.	1842200000	PCB plug-in connector, male header, Flange, THT/THR solder	IEC: 320 V / 15 A	Box
GTIN (EAN)	4032248353552	connection, 3.50 mm, Number of poles: 14, 90°, Solder pin length (l):	UL: 300 V / 10 A	
Qty.	30 pc(s).	3.2 mm, tinned, black, Box		

**OMNIMATE Signal - series BL/SL 3.50
BL 3.50/14/270 SN OR BX**

Weidmüller Interface GmbH & Co. KG
Klingenbergstraße 26
D-32758 Detmold
Germany
Fon: +49 5231 14-0
Fax: +49 5231 14-292083
www.weidmueller.com

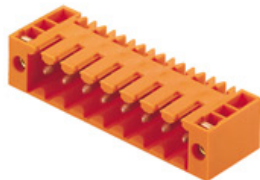
Mating connector (conditionally pluggable)
SL 3.50/90F

Pin headers for wave soldering in 3.50 mm pitch

- Plugging direction is parallel (90°), straight 180° or angled (135°) to the PCB
- Housing variant: screw flange (F)
- Packed in a cardboard box (BX)
- Pin header can be coded

General ordering data

Type	SL 3.50/14/90F 4.5SN OR ...	Version	Product data	Packaging
Order No.	1618170000	PCB plug-in connector, male header, Flange, THT solder connection,	IEC: / 17 A	Box
GTIN (EAN)	4008190117252	3.50 mm, Number of poles: 14, 90°, Solder pin length (l): 4.5 mm,	UL: 300 V / 10 A	
Qty.	50 pc(s).	tinned, orange, Box		
Type	SL 3.50/14/90F 3.2SN DK ...	Version	Product data	Packaging
Order No.	1620180000	PCB plug-in connector, male header, Flange, THT solder connection,	IEC: / 17 A	Box
GTIN (EAN)	4008190152680	3.50 mm, Number of poles: 14, 90°, Solder pin length (l): 3.2 mm,	UL: 300 V / 10 A	
Qty.	50 pc(s).	tinned, Signal green, Box		
Type	SL 3.50/14/90F 3.2SN GY ...	Version	Product data	Packaging
Order No.	1619970000	PCB plug-in connector, male header, Flange, THT solder connection,	IEC: / 17 A	Box
GTIN (EAN)	4008190150013	3.50 mm, Number of poles: 14, 90°, Solder pin length (l): 3.2 mm,	UL: 300 V / 10 A	
Qty.	50 pc(s).	tinned, Pebble grey, Box		
Type	SL 3.50/14/90F 3.2SN OR ...	Version	Product data	Packaging
Order No.	1607160000	PCB plug-in connector, male header, Flange, THT solder connection,	IEC: / 17 A	Box
GTIN (EAN)	4008190003340	3.50 mm, Number of poles: 14, 90°, Solder pin length (l): 3.2 mm,	UL: 300 V / 10 A	
Qty.	50 pc(s).	tinned, orange, Box		
Type	SL 3.50/14/90F 4.5SN BK ...	Version	Product data	Packaging
Order No.	1615640000	PCB plug-in connector, male header, Flange, THT solder connection,	IEC: / 17 A	Box
GTIN (EAN)	4008190058227	3.50 mm, Number of poles: 14, 90°, Solder pin length (l): 4.5 mm,	UL: 300 V / 10 A	
Qty.	50 pc(s).	tinned, black, Box		

**OMNIMATE Signal - series BL/SL 3.50
BL 3.50/14/270 SN OR BX**

Weidmüller Interface GmbH & Co. KG
Klingenbergstraße 26
D-32758 Detmold
Germany
Fon: +49 5231 14-0
Fax: +49 5231 14-292083
www.weidmueller.com

Mating connector (conditionally pluggable)
SL-SMT 3.5/180LF Box

High-temperature-resistant male header, 3.50 mm pitch.

- **Plugging direction parallel (90°), straight 180° or angled (135°) to PCB**
- **Housing variants: closed side (G), screw flange (F), solder flange (LF) or snap-on solder flange (RF)**
- **Optimised for the SMT process**
- **Pin length 3.2 mm universal for all soldering methods**
- **Pin length 1.5 mm optimised for reflow soldering methods**
- **Packed either in a box (BX) or tape-on-reel (RL)**
- **Male header can be coded**

General ordering data

Type	SL-SMT 3.50/14/180LF 3. ...	Version	Product data	Packaging
Order No.	1842660000	PCB plug-in connector, male header, Solder flange, THT/THR solder connection, 3.50 mm, Number of poles: 14, 180°, Solder pin length (l): 3.2 mm, tinned, black, Box	IEC: 320 V / 15 A UL: 300 V / 10 A	Box
GTIN (EAN)	4032248354023			
Qty.	30 pc(s).			
Type	SL-SMT 3.50/14/180LF 1. ...	Version	Product data	Packaging
Order No.	1804820000	PCB plug-in connector, male header, Solder flange, THT/THR solder connection, 3.50 mm, Number of poles: 14, 180°, Solder pin length (l): 1.5 mm, tinned, black, Box	IEC: 320 V / 15 A UL: 300 V / 10 A	Box
GTIN (EAN)	4032248268597			
Qty.	50 pc(s).			

**OMNIMATE Signal - series BL/SL 3.50
BL 3.50/14/270 SN OR BX**

Weidmüller Interface GmbH & Co. KG
Klingenbergstraße 26
D-32758 Detmold
Germany
Fon: +49 5231 14-0
Fax: +49 5231 14-292083
www.weidmueller.com

Mating connector (fully pluggable)
SL-SMT 3.5/90G Tray

High-temperature-resistant male header, 3.50 mm pitch.

- **Plugging direction parallel (90°), straight 180° or angled (135°) to PCB**
- **Housing variants: closed side (G), screw flange (F), solder flange (LF) or snap-on solder flange (RF)**
- **Optimised for the SMT process**
- **Pin length 3.2 mm universal for all soldering methods**
- **Pin length 1.5 mm optimised for reflow soldering methods**
- **Packed either in a box (BX) or tape-on-reel (RL)**
- **Male header can be coded**

General ordering data

Type	SL-SMT 3.50/14/90G 1.5S ...	Version	Product data	Packaging
Order No.	1761663001	PCB plug-in connector, male header, closed side, THT/THR solder connection, 3.50 mm, Number of poles: 14, 90°, Solder pin length (l): 1.5 mm, tinned, black, Tray	IEC: 320 V / 15 A	Tray
GTIN (EAN)	4032248133932		UL: 300 V / 10 A	
Qty.	30 pc(s).			

SL-THR 3.5/135F

High-temperature-resistant male header, 3.50 mm pitch.

- **Plugging direction parallel (90°), straight 180° or angled (135°) to PCB**
- **Housing variants: closed side (G), screw flange (F), solder flange (LF) or snap-on solder flange (RF)**
- **Optimised for the SMT process**
- **Pin length 3.2 mm universal for all soldering methods**
- **Pin length 1.5 mm optimised for reflow soldering methods**
- **Packed either in a box (BX) or tape-on-reel (RL)**
- **Male header can be coded**

General ordering data

Type	SL-SMT 3.50/14/135F 3.2 ...	Version	Product data	Packaging
Order No.	1003640000	PCB plug-in connector, male header, Flange, THT/THR solder connection, 3.50 mm, Number of poles: 14, 135°, Solder pin length (l): 3.2 mm, tinned, black, Box	IEC: 320 V / 15 A	Box
GTIN (EAN)	4032248700264		UL: 300 V / 10 A	
Qty.	30 pc(s).			

OMNIMATE Signal - series BL/SL 3.50
BL 3.50/14/270 SN OR BX

Weidmüller Interface GmbH & Co. KG
Klingenbergstraße 26
D-32758 Detmold
Germany
Fon: +49 5231 14-0
Fax: +49 5231 14-292083
www.weidmueller.com

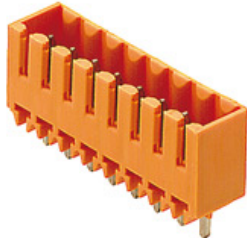
Mating connector (fully pluggable)**SL 3.50/180G**

Pin headers for wave soldering in 3.50 mm pitch

- Plugging direction is parallel (90°), straight 180° or angled (135°) to the PCB
- Housing variant: screw flange (F)
- Packed in a cardboard box (BX)
- Pin header can be coded

General ordering data

Type	SL 3.50/14/180G 4.5 SN ...	Version	Product data	Packaging
Order No.	1604740000	PCB plug-in connector, male header, closed side, THT solder	IEC: 320 V / 17 A	Box
GTIN (EAN)	4008190047283	connection, 3.50 mm, Number of poles: 14, 180°, Solder pin length	UL: 300 V / 10 A	
Qty.	50 pc(s).	(I): 4.5 mm, tinned, orange, Box		
Type	SL 3.50/14/180G 4.5SN B ...	Version	Product data	Packaging
Order No.	1616120000	PCB plug-in connector, male header, closed side, THT solder	IEC: 320 V / 17 A	Box
GTIN (EAN)	4008190067571	connection, 3.50 mm, Number of poles: 14, 180°, Solder pin length	UL: 300 V / 10 A	
Qty.	50 pc(s).	(I): 4.5 mm, tinned, black, Box		
Type	SL 3.50/14/180G 3.2SN O ...	Version	Product data	Packaging
Order No.	1604590000	PCB plug-in connector, male header, closed side, THT solder	IEC: 320 V / 17 A	Box
GTIN (EAN)	4008190041465	connection, 3.50 mm, Number of poles: 14, 180°, Solder pin length	UL: 300 V / 10 A	
Qty.	50 pc(s).	(I): 3.2 mm, tinned, orange, Box		

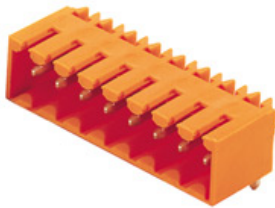
SL 3.50/90G

Pin headers for wave soldering in 3.50 mm pitch

- Plugging direction is parallel (90°), straight 180° or angled (135°) to the PCB
- Housing variant: screw flange (F)
- Packed in a cardboard box (BX)
- Pin header can be coded

General ordering data

Type	SL 3.50/14/90G 3.2SN OR ...	Version	Product data	Packaging
Order No.	1605190000	PCB plug-in connector, male header, closed side, THT solder	IEC: / 17 A	Box
GTIN (EAN)	4008190097318	connection, 3.50 mm, Number of poles: 14, 90°, Solder pin length (I):	UL: 300 V / 10 A	
Qty.	50 pc(s).	3.2 mm, tinned, orange, Box		
Type	SL 3.50/14/90G 4.5SN BK ...	Version	Product data	Packaging
Order No.	1615510000	PCB plug-in connector, male header, closed side, THT solder	IEC: / 17 A	Box
GTIN (EAN)	4008190056254	connection, 3.50 mm, Number of poles: 14, 90°, Solder pin length (I):	UL: 300 V / 10 A	
Qty.	50 pc(s).	4.5 mm, tinned, black, Box		
Type	SL 3.50/14/90G 3.2SN GY ...	Version	Product data	Packaging
Order No.	1619580000	PCB plug-in connector, male header, closed side, THT solder	IEC: / 17 A	Box
GTIN (EAN)	4008190142643	connection, 3.50 mm, Number of poles: 14, 90°, Solder pin length (I):	UL: 300 V / 10 A	
Qty.	50 pc(s).	3.2 mm, tinned, Pebble grey, Box		

**OMNIMATE Signal - series BL/SL 3.50
BL 3.50/14/270 SN OR BX**

Weidmüller Interface GmbH & Co. KG
Klingenbergstraße 26
D-32758 Detmold
Germany
Fon: +49 5231 14-0
Fax: +49 5231 14-292083
www.weidmueller.com

Mating connector (fully pluggable)

Type	SL 3.50/14/90G 4.5SN OR ...	Version	Product data	Packaging
Order No.	1605340000	PCB plug-in connector, male header, closed side, THT solder	IEC: / 17 A	Box
GTIN (EAN)	4008190072025	connection, 3.50 mm, Number of poles: 14, 90°, Solder pin length (l):	UL: 300 V / 10 A	
Qty.	50 pc(s).	4.5 mm, tinned, orange, Box		
Type	SL 3.50/14/90G 3.2SN DK ...	Version	Product data	Packaging
Order No.	1607010000	PCB plug-in connector, male header, closed side, THT solder	IEC: / 17 A	Box
GTIN (EAN)	4008190094652	connection, 3.50 mm, Number of poles: 14, 90°, Solder pin length (l):	UL: 300 V / 10 A	
Qty.	50 pc(s).	3.2 mm, tinned, Signal green, Box		

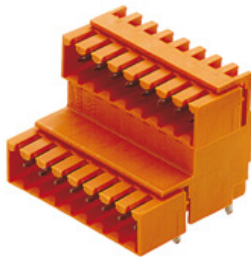
SLD 3.50V/90G

Double-level, staggered pin header for wave soldering at 3.50 mm pitch. They are available in closed and flanged versions. The male connectors provide space for labelling and can be coded.

General ordering data

Type	SLD 3.50V/28/90G 3.2SN ...	Version	Product data	Packaging
Order No.	1642300000	PCB plug-in connector, male header, closed side, THT solder	IEC: 200 V / 10.5 A	Box
GTIN (EAN)	4008190280826	connection, 3.50 mm, Number of poles: 28, 90°, Solder pin length (l):	UL: 300 V / 8 A	
Qty.	10 pc(s).	3.2 mm, tinned, orange, Box		

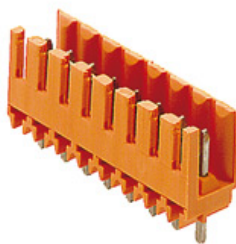
SL 3.50/180

Pin headers for wave soldering in 3.50 mm pitch

- Plugging direction is parallel (90°), straight 180° or angled (135°) to the PCB
- Housing variant: screw flange (F)
- Packed in a cardboard box (BX)
- Pin header can be coded

General ordering data

Type	SL 3.50/14/180 3.2SN OR ...	Version	Product data	Packaging
Order No.	1604890000	PCB plug-in connector, male header, open side, THT solder	IEC: 320 V / 17 A	Box
GTIN (EAN)	4008190025595	connection, 3.50 mm, Number of poles: 14, 180°, Solder pin length	UL: 300 V / 10 A	
Qty.	50 pc(s).	(l): 3.2 mm, tinned, orange, Box		

**OMNIMATE Signal - series BL/SL 3.50
BL 3.50/14/270 SN OR BX**

Weidmüller Interface GmbH & Co. KG
Klingenbergstraße 26
D-32758 Detmold
Germany
Fon: +49 5231 14-0
Fax: +49 5231 14-292083
www.weidmueller.com

Mating connector (fully pluggable)
SL-SMT 3.5/180G Tray

High-temperature-resistant male header, 3.50 mm pitch.

- **Plugging direction parallel (90°), straight 180° or angled (135°) to PCB**
- **Housing variants: closed side (G), screw flange (F), solder flange (LF) or snap-on solder flange (RF)**
- **Optimised for the SMT process**
- **Pin length 3.2 mm universal for all soldering methods**
- **Pin length 1.5 mm optimised for reflow soldering methods**
- **Packed either in a box (BX) or tape-on-reel (RL)**
- **Male header can be coded**

General ordering data

Type	SL-SMT 3.50/14/180G 1.5 ...	Version	Product data	Packaging
Order No.	1753103001	PCB plug-in connector, male header, closed side, THT/THR solder connection, 3.50 mm, Number of poles: 14, 180°, Solder pin length (l): 1.5 mm, tinned, black, Tray	IEC: 320 V / 15 A UL: 300 V / 10 A	Tray
GTIN (EAN)	4032248132935			
Qty.	30 pc(s).			

SL-SMT 3.5/90G Box

High-temperature-resistant male header, 3.50 mm pitch.

- **Plugging direction parallel (90°), straight 180° or angled (135°) to PCB**
- **Housing variants: closed side (G), screw flange (F), solder flange (LF) or snap-on solder flange (RF)**
- **Optimised for the SMT process**
- **Pin length 3.2 mm universal for all soldering methods**
- **Pin length 1.5 mm optimised for reflow soldering methods**
- **Packed either in a box (BX) or tape-on-reel (RL)**
- **Male header can be coded**

General ordering data

Type	SL-SMT 3.50/14/90G 3.2S ...	Version	Product data	Packaging
Order No.	1841750000	PCB plug-in connector, male header, closed side, THT/THR solder connection, 3.50 mm, Number of poles: 14, 90°, Solder pin length (l): 3.2 mm, tinned, black, Box	IEC: 320 V / 15 A UL: 300 V / 10 A	Box
GTIN (EAN)	4032248353101			
Qty.	50 pc(s).			

**OMNIMATE Signal - series BL/SL 3.50
BL 3.50/14/270 SN OR BX**

Weidmüller Interface GmbH & Co. KG
Klingenbergstraße 26
D-32758 Detmold
Germany
Fon: +49 5231 14-0
Fax: +49 5231 14-292083
www.weidmueller.com

Mating connector (fully pluggable)

Type	SL-SMT 3.50/14/90G 1.5S ...	Version	Product data	Packaging
Order No.	1761662001	PCB plug-in connector, male header, closed side, THT/THR solder	IEC: 320 V / 15 A	Box
GTIN (EAN)	4032248132256	connection, 3.50 mm, Number of poles: 14, 90°, Solder pin length (l):	UL: 300 V / 10 A	
Qty.	50 pc(s).	1.5 mm, tinned, black, Box		

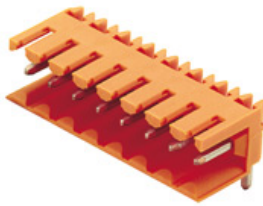
SL 3.50/90

Pin headers for wave soldering in 3.50 mm pitch

- Plugging direction is parallel (90°), straight 180° or angled (135°) to the PCB
- Housing variant: screw flange (F)
- Packed in a cardboard box (BX)
- Pin header can be coded

General ordering data

Type	SL 3.50/14/90 3.2SN GY ...	Version	Product data	Packaging
Order No.	1619190000	PCB plug-in connector, male header, open side, THT solder	IEC: 320 V / 17 A	Box
GTIN (EAN)	4008190135744	connection, 3.50 mm, Number of poles: 14, 90°, Solder pin length (l):	UL: 300 V / 10 A	
Qty.	50 pc(s).	3.2 mm, tinned, Pebble grey, Box		
Type	SL 3.50/14/90 3.2SN OR ...	Version	Product data	Packaging
Order No.	1597330000	PCB plug-in connector, male header, open side, THT solder	IEC: 320 V / 17 A	Box
GTIN (EAN)	4008190129903	connection, 3.50 mm, Number of poles: 14, 90°, Solder pin length (l):	UL: 300 V / 10 A	
Qty.	50 pc(s).	3.2 mm, tinned, orange, Box		
Type	SL 3.50/14/90 4.5SN OR ...	Version	Product data	Packaging
Order No.	1605490000	PCB plug-in connector, male header, open side, THT solder	IEC: 320 V / 17 A	Box
GTIN (EAN)	4008190049362	connection, 3.50 mm, Number of poles: 14, 90°, Solder pin length (l):	UL: 300 V / 10 A	
Qty.	50 pc(s).	4.5 mm, tinned, orange, Box		
Type	SL 3.50/14/90 4.5SN BK ...	Version	Product data	Packaging
Order No.	1615400000	PCB plug-in connector, male header, open side, THT solder	IEC: 320 V / 17 A	Box
GTIN (EAN)	4008190054229	connection, 3.50 mm, Number of poles: 14, 90°, Solder pin length (l):	UL: 300 V / 10 A	
Qty.	50 pc(s).	4.5 mm, tinned, black, Box		
Type	SL 3.50/14/90 3.2SN DKG ...	Version	Product data	Packaging
Order No.	1606890000	PCB plug-in connector, male header, open side, THT solder	IEC: 320 V / 17 A	Box
GTIN (EAN)	4008190018641	connection, 3.50 mm, Number of poles: 14, 90°, Solder pin length (l):	UL: 300 V / 10 A	
Qty.	50 pc(s).	3.2 mm, tinned, Signal green, Box		

**OMNIMATE Signal - series BL/SL 3.50
BL 3.50/14/270 SN OR BX**

Weidmüller Interface GmbH & Co. KG
Klingenbergstraße 26
D-32758 Detmold
Germany
Fon: +49 5231 14-0
Fax: +49 5231 14-292083
www.weidmueller.com

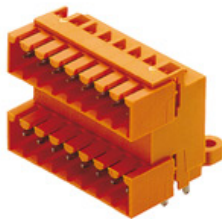
Mating connector (fully pluggable)
SLD 3.50/90G

Two-tier pin header for wave soldering in 3.50 mm pitch. The connector is available in open, closed and flange versions. The male connectors provide space for labelling and can be coded. Packed in a cardboard box.

General ordering data

Type	SLD 3.50/28/90G 4.5SN B ...	Version	Product data	Packaging
Order No.	1634390000	PCB plug-in connector, male header, closed side, THT solder connection, 3.50 mm, Number of poles: 28, 90°, Solder pin length (l): 4.5 mm, tinned, black, Box	IEC: 200 V / 10.5 A UL: 300 V / 8 A	Box
GTIN (EAN)	4008190258849			
Qty.	10 pc(s).			
Type	SLD 3.50/28/90G 3.2SN D ...	Version	Product data	Packaging
Order No.	1674970000	PCB plug-in connector, male header, closed side, THT solder connection, 3.50 mm, Number of poles: 28, 90°, Solder pin length (l): 3.2 mm, tinned, Signal green, Box	IEC: 200 V / 10.5 A UL: 300 V / 8 A	Box
GTIN (EAN)	4008190445669			
Qty.	10 pc(s).			
Type	SLD 3.50/28/90G 3.2SN O ...	Version	Product data	Packaging
Order No.	1633700000	PCB plug-in connector, male header, closed side, THT solder connection, 3.50 mm, Number of poles: 28, 90°, Solder pin length (l): 3.2 mm, tinned, orange, Box	IEC: 200 V / 10.5 A UL: 300 V / 8 A	Box
GTIN (EAN)	4008190258153			
Qty.	10 pc(s).			

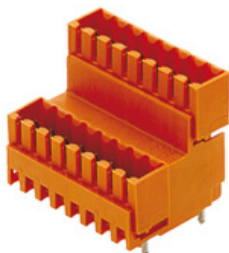
SLD 3.50V/180G

Double-level, staggered pin header for wave soldering at 3.50 mm pitch. They are available in closed and flanged versions. The male connectors provide space for labelling and can be coded.

General ordering data

Type	SLD 3.50V/28/180G 3.2SN ...	Version	Product data	Packaging
Order No.	1641170000	PCB plug-in connector, male header, closed side, THT solder connection, 3.50 mm, Number of poles: 28, 180°, Solder pin length (l): 3.2 mm, tinned, orange, Box	IEC: 200 V / 10.5 A UL: 300 V / 8 A	Box
GTIN (EAN)	4008190279578			
Qty.	10 pc(s).			

OMNIMATE Signal - series BL/SL 3.50 BL 3.50/14/270 SN OR BX

Weidmüller Interface GmbH & Co. KG
 Klingenbergstraße 26
 D-32758 Detmold
 Germany
 Fon: +49 5231 14-0
 Fax: +49 5231 14-292083
 www.weidmueller.com

Accessories

Coding elements



**Only connects what is supposed to be connected:
the right connection at the right place.**

Coding elements and locking devices clearly assign connecting elements during the manufacturing process and operation

The coding elements and locking devices are inserted prior to assembly or during the cable assembly phase. The Weidmüller alternative: configure online using the variant configurator to precode prior to delivery.

Incorrect assembly on the circuit board and incorrect plugging of connecting elements is no longer possible. The advantage: no troubleshooting during manufacture and no operational errors by the user.

General ordering data

Type	BL SL 3.5 KO SW	Version	Product data	Packaging
Order No.	1610100000	PCB plug-in connector, Accessories, Coding element, black, Number		Box
GTIN (EAN)	4008190187637	of poles: 1		
Qty.	100 pc(s).			
Type	BL SL 3.5 KO OR	Version	Product data	Packaging
Order No.	1693430000	PCB plug-in connector, Accessories, Coding element, orange, Number		Box
GTIN (EAN)	4008190867447	of poles: 1		
Qty.	100 pc(s).			

WEITERGABE SOWIE VERVIELFÄLTIGUNG DIESES DOKUMENTS, VERWERTUNG UND MITTEILUNG SEINES INHALTS SIND VERBOTEN, SOWEIT NICHT AUSDRUECKLICH GESTATTET. ZUWIDERHANDLUNGEN VERPFLICHTEN ZU SCHADENERSATZ. ALLE RECHTE FUER DEN FALL DER PATENT-, GEBRAUCHSMUSTER- ODER GESCHMACKSMUSTEREINTRAGUNG VORBEHALTEN. THE REPRODUCTION, DISTRIBUTION AND UTILIZATION OF THIS DOCUMENT AS WELL AS THE COMMUNICATION OF ITS CONTENTS TO OTHERS WITHOUT EXPLICIT AUTHORIZATION IS PROHIBITED. OFFENDERS WILL BE HELD LIABLE FOR THE PAYMENT OF DAMAGES. WEIDMUELLER EXCLUSIVELY RESERVES THE RIGHT TO FILE FOR PATENTS, UTILITY MODELS OR DESIGNS. © WEIDMUELLER INTERFACE GmbH & Co.KG

DIE DEUTSCHE VERSION IST VERBINDLICH
THE GERMAN VERSION IS BINDING

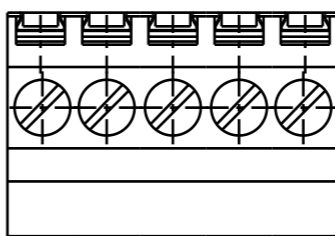
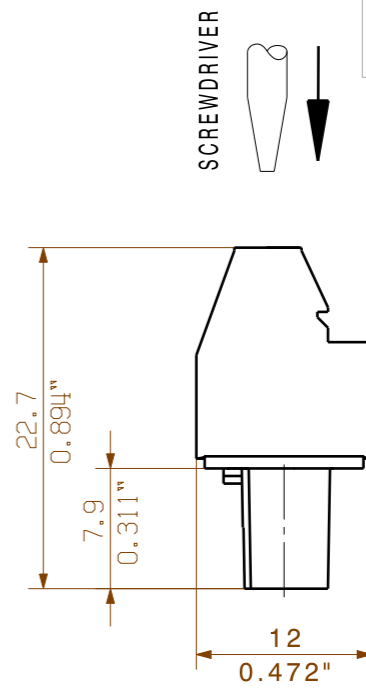
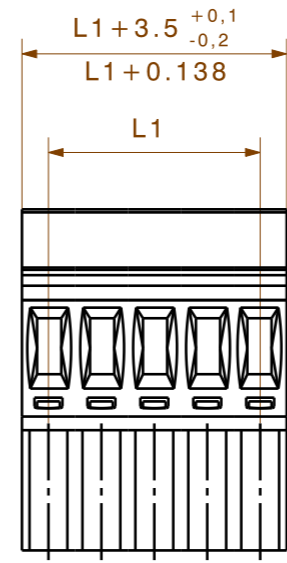

24	80,50	3,169
23	77,00	3,031
22	73,50	2,894
21	70,00	2,756
20	66,50	2,618
19	63,00	2,480
18	59,50	2,343
17	56,00	2,205
16	52,50	2,067
15	49,00	1,929
14	45,50	1,791
13	42,00	1,654
12	38,50	1,516
11	35,00	1,378
10	31,50	1,240
9	28,00	1,102
8	24,50	0,965
7	21,00	0,827
6	17,50	0,689
5	14,00	0,551
4	10,50	0,413
3	7,00	0,276
2	3,50	0,138
n	L1[mm]	L1 [Inch]

For the mounting of PCBs, it should be noted that the rated data stated here relates only to the PCB components alone. The necessary creepage and clearance paths must be observed in connection with the respective applicant in accordance to IEC 664 / VDE 0110. The current-carrying capacity and pitch tolerance is to be determined according to DIN IEC 326 part 3 very fine.

Weidmüller PCB components are tested to the DIN EN 61984 standard, and are valid for its field of application. Provided that the components are used to the intended purpose, all requirements with respect to the occurring of electrical, mechanical, thermic and corrosive stress will be satisfied.

SHOWN : BL3.50/05/270

	DIN ISO 2768-m		CAT.NO.: .	
	74368/5 15.04.14 HELIS_MA 01			
MODIFICATION		DRAWING NO. C 21347 09		ISSUE NO.
DRAWN 24.07.2003 KOWOLLIK_R		SHEET 01 OF 02 SHEETS		
RESPONSIBLE LANG_T		BL 3.50/.../270... BUCHSENLEISTE SOCKET BLOCK		
CHECKED 15.04.2014 THELEN_E				
APPROVED HECKERT_M		PRODUCT FILE: BL 3.50 90/270		7368
SCALE: 5/1				
SUPERSEDES: .				