

OMNIMATE Signal - series BL/SL 3.50 BL 3.50/10/270 SN OR BX

Weidmüller Interface GmbH & Co. KG
Klingenbergstraße 26
D-32758 Detmold
Germany
Fon: +49 5231 14-0
Fax: +49 5231 14-292083
www.weidmueller.com

Product image

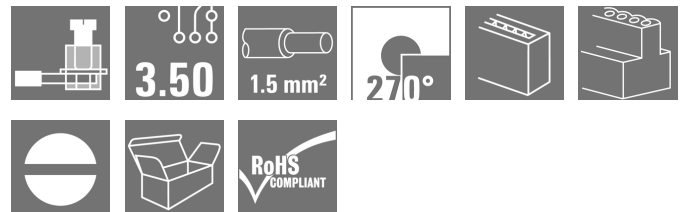

Similar to illustration

Female connectors with clamping yoke screw system for connecting conductors at 3.50 mm pitch. They provide space for labelling and can be coded.

General ordering data

Type	BL 3.50/10/270 SN OR BX
Order No.	1639550000
Version	PCB plug-in connector, female plug, 3.50 mm, Number of poles: 10, 270°, Clamping yoke connection, Clamping range, max. : 1.5 mm², Box
GTIN (EAN)	4008190277109
Qty.	48 pc(s).
Product data	IEC: 320 V / 12 A / 0.2 - 1.5 mm² UL: 300 V / 8 A / AWG 28 - AWG 14
Packaging	Box

Creation date May 3, 2020 5:33:07 PM CEST

OMNIMATE Signal - series BL/SL 3.50
BL 3.50/10/270 SN OR BX

Weidmüller Interface GmbH & Co. KG
 Klingenbergstraße 26
 D-32758 Detmold
 Germany
 Fon: +49 5231 14-0
 Fax: +49 5231 14-292083
 www.weidmueller.com

Technical data
Dimensions and weights

Width	35 mm	Width (inches)	1.378 inch
Height	12 mm	Height (inches)	0.472 inch
Depth	22.45 mm	Depth (inches)	0.884 inch
Net weight	10.04 g		

System Parameters

Product family	OMNIMATE Signal - series BL/SL 3.50	Type of connection	Field connection
Wire connection method	Clamping yoke connection	Pitch in mm (P)	3.5 mm
Pitch in inches (P)	0.138 inch	Conductor outlet direction	270°
Number of poles	10	L1 in mm	31.5 mm
L1 in inches	1.24 inch	Number of rows	1
Pin series quantity	1	Rated cross-section	1.5 mm ²
Touch-safe protection acc. to DIN VDE 57 106	Safe from finger touch	Touch-safe protection acc. to DIN VDE 0470	IP 20
Volume resistance	≤ 5mΩ	Can be coded	Yes
Stripping length	6 mm	Tightening torque, min.	0.2 Nm
Tightening torque, max.	0.25 Nm	Clamping screw	M 2
Screwdriver blade	0.4 x 2.5	Screwdriver blade standard	DIN 5264
Plugging cycles	25	Plugging force/pole, max.	7 N
Pulling force/pole, max.	5 N		

Material data

Insulating material	PBT	Colour	orange
Colour chart (similar)	RAL 2000	Insulating material group	IIIa
Comparative Tracking Index (CTI)	≥ 200	Insulation strength	≥ 10 ⁸ Ω
UL 94 flammability rating	V-0	GWFI	960 °C
Contact material	Copper alloy	Contact surface	tinned
Layer structure of plug contact	4-8 μm Sn hot-dip tinned	Storage temperature, min.	-25 °C
Storage temperature, max.	50 °C	Max. relative humidity during storage	70 %
Operating temperature, min.	-50 °C	Operating temperature, max.	100 °C
Temperature range, installation, min.	-30 °C	Temperature range, installation, max.	100 °C

Conductors suitable for connection

Clamping range, min.	0.08 mm ²
Clamping range, max.	1.5 mm ²
Wire connection cross section AWG, min.	AWG 28
Wire connection cross section AWG, max.	AWG 14
Solid, min. H05(07) V-U	0.2 mm ²
Solid, max. H05(07) V-U	1.5 mm ²
Flexible, min. H05(07) V-K	0.2 mm ²
Flexible, max. H05(07) V-K	1.5 mm ²
w. plastic collar ferrule, DIN 46228 pt 4, 0.2 mm ² min.	
w. plastic collar ferrule, DIN 46228 pt 4, 1.5 mm ² max.	
w. wire end ferrule, DIN 46228 pt 1, 0.2 mm ² min.	
w. wire end ferrule, DIN 46228 pt 1, 1.5 mm ² max.	

Creation date May 3, 2020 5:33:07 PM CEST

OMNIMATE Signal - series BL/SL 3.50
BL 3.50/10/270 SN OR BX

Weidmüller Interface GmbH & Co. KG
 Klingenbergstraße 26
 D-32758 Detmold
 Germany
 Fon: +49 5231 14-0
 Fax: +49 5231 14-292083
 www.weidmueller.com

Technical data

Plug gauge in accordance with EN 60999 a x b; ø 2.4 mm x 1.5 mm

Clampable conductor	Cross-section for conductor connection	Type	fine-wired
		nominal	0.5 mm ²
wire end ferrule	Stripping length	nominal	8 mm
		Recommended wire-end ferrule	H0.5/12 OR
		nominal	6 mm
		Recommended wire-end ferrule	H0.5/6
Cross-section for conductor connection	Type	fine-wired	
	nominal	0.75 mm ²	
wire end ferrule	Stripping length	nominal	8 mm
		Recommended wire-end ferrule	H0.75/12 W
		nominal	6 mm
		Recommended wire-end ferrule	H0.75/6
Cross-section for conductor connection	Type	fine-wired	
	nominal	1 mm ²	
wire end ferrule	Stripping length	nominal	8 mm
		Recommended wire-end ferrule	H1.0/12 GE
		nominal	6 mm
		Recommended wire-end ferrule	H1.0/6
Cross-section for conductor connection	Type	fine-wired	
	nominal	0.25 mm ²	
wire end ferrule	Stripping length	nominal	8 mm
		Recommended wire-end ferrule	H0.25/10 HBL
		nominal	5 mm
		Recommended wire-end ferrule	H0.25/5
Cross-section for conductor connection	Type	fine-wired	
	nominal	0.34 mm ²	
wire end ferrule	Stripping length	nominal	8 mm
	Recommended wire-end ferrule	H0.34/10 TK	

Reference text The outside diameter of the plastic collar should not be larger than the pitch (P). Length of ferrules is to be chosen depending on the product and the rated voltage.

Max. clamping range 1.5 mm²

Rated data acc. to IEC

tested acc. to standard	IEC 60664-1, IEC 61984	Rated current, min. number of poles (Tu=20°C)	12 A
Rated current, max. number of poles (Tu=20°C)	10 A	Rated current, min. number of poles (Tu=40°C)	10 A
Rated current, max. number of poles (Tu=40°C)	8 A	Rated voltage for surge voltage class / pollution degree II/2	320 V
Rated voltage for surge voltage class / pollution degree III/2	160 V	Rated voltage for surge voltage class / pollution degree III/3	160 V
Rated impulse voltage for surge voltage class/ pollution degree II/2	2.5 kV	Rated impulse voltage for surge voltage class/ pollution degree III/2	2.5 kV
Rated impulse voltage for surge voltage class/ contamination degree III/3	2.5 kV	Short-time withstand current resistance	3 x 1s with 100 A

**OMNIMATE Signal - series BL/SL 3.50
BL 3.50/10/270 SN OR BX**

Weidmüller Interface GmbH & Co. KG
Klingenbergstraße 26
D-32758 Detmold
Germany
Fon: +49 5231 14-0
Fax: +49 5231 14-292083
www.weidmueller.com

Technical data

Rated data acc. to CSA

Institute (CSA)				Certificate No. (CSA)	
				154685-1318353	
Rated voltage (Use group B / CSA)	300 V	Rated voltage (Use group D / CSA)	300 V		
Rated current (Use group B / CSA)	10 A	Rated current (Use group D / CSA)	10 A		
Wire cross-section, AWG, min.	AWG 28	Wire cross-section, AWG, max.	AWG 14		
Reference to approval values	Specifications are maximum values, details - see approval certificate.				

Rated data acc. to UL 1059

Institute (UR)				Certificate No. (UR)	
				E60693	
Rated voltage (Use group B / UL 1059)	300 V	Rated voltage (Use group D / UL 1059)	300 V		
Rated current (Use group B / UL 1059)	8 A	Rated current (Use group D / UL 1059)	8 A		
Wire cross-section, AWG, min.	AWG 28	Wire cross-section, AWG, max.	AWG 14		
Reference to approval values	Specifications are maximum values, details - see approval certificate.				

Packing

Packaging	Box	VPE length	67 mm
VPE width	106 mm	VPE height	136 mm

Classifications

ETIM 6.0	EC002638	ETIM 7.0	EC002638
eClass 9.0	27-44-03-09	eClass 9.1	27-44-03-09
eClass 10.0	27-44-03-09	UNSPSC	30-21-18-10

OMNIMATE Signal - series BL/SL 3.50 BL 3.50/10/270 SN OR BX

Weidmüller Interface GmbH & Co. KG
Klingenbergstraße 26
D-32758 Detmold
Germany
Fon: +49 5231 14-0
Fax: +49 5231 14-292083
www.weidmueller.com

Technical data

Notes

Notes	<ul style="list-style-type: none"> • Additional colours on request • Gold-plated contact surfaces on request • Rated current related to rated cross-section & min. No. of poles. • Max. outer diameter of the conductor: 2.9 mm • Wire end ferrule without plastic collar to DIN 46228/1 • Wire end ferrule with plastic collar to DIN 46228/4 • P on drawing = pitch • Rated data refer only to the component itself. Clearance and creepage distances to other components are to be designed in accordance with the relevant application standards.
IPC conformity	Conformity: The products are developed, manufactured and delivered according international recognized standards and norms and comply with the assured properties in the data sheet resp. fulfill decorative properties in accordance with IPC-A-610 "Class 2". Further claims on the products can be evaluated on request.

Approvals

Approvals



ROHS

Conform

Downloads

Approval/Certificate/Document of Conformity	Declaration of the Manufacturer
Brochure/Catalogue	FL DRIVES EN MB DEVICE MANUF. EN FL DRIVES DE CAT 2 PORTFOLIOGUIDE EN FL BUILDING SAFETY EN FL APPL LED LIGHTING EN FLIndustr.CONTROLS EN FL MACHINE SAFETY EN FL HEATING ELECTR EN FL APPL INVERTER EN FL_BASE_STATION EN FL ELEVATOR EN FL POWER SUPPLY EN FL 72H SAMPLE SER EN PO OMNIMATE EN
Engineering Data	STEP

**OMNIMATE Signal - series BL/SL 3.50
BL 3.50/10/270 SN OR BX**

Weidmüller Interface GmbH & Co. KG
Klingenbergstraße 26
D-32758 Detmold
Germany
Fon: +49 5231 14-0
Fax: +49 5231 14-292083
www.weidmueller.com

Drawings

Dimensional drawing

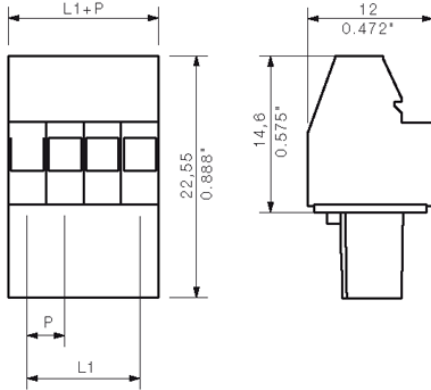

Graph

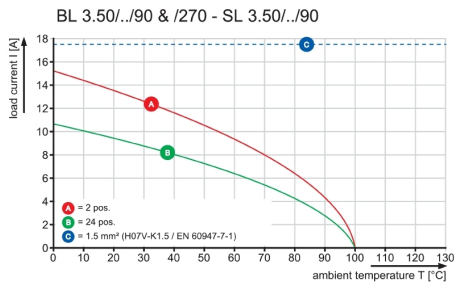

Graph

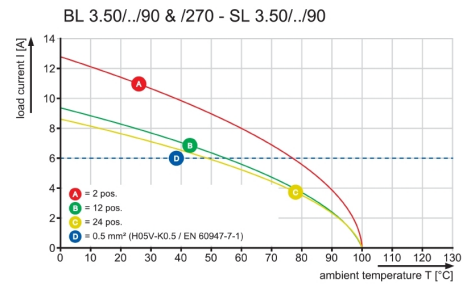

**OMNIMATE Signal - series BL/SL 3.50
BL 3.50/10/270 SN OR BX**

Weidmüller Interface GmbH & Co. KG
Klingenbergstraße 26
D-32758 Detmold
Germany
Fon: +49 5231 14-0
Fax: +49 5231 14-292083
www.weidmueller.com

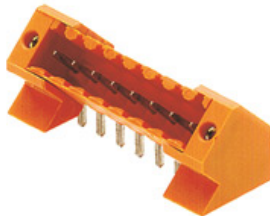
Mating connector (conditionally pluggable)
SL 3.50/135F

Pin headers for wave soldering in 3.50 mm pitch

- Plugging direction is parallel (90°), straight 180° or angled (135°) to the PCB
- Housing variant: screw flange (F)
- Packed in a cardboard box (BX)
- Pin header can be coded

General ordering data

Type	SL 3.50/10/135F 3.2SN O ...	Version	Product data	Packaging
Order No.	1643410000	PCB plug-in connector, male header, Flange, THT solder connection,	IEC: 320 V / 15 A	Box
GTIN (EAN)	4008190282172	3.50 mm, Number of poles: 10, 135°, Solder pin length (l): 3.2 mm,	UL: 300 V / 10 A	
Qty.	42 pc(s).	tinned, orange, Box		

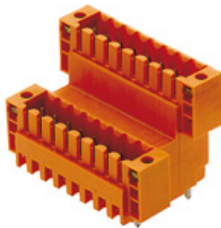
SLD 3.50V/180F

Double-level, staggered pin header for wave soldering at 3.50 mm pitch. They are available in closed and flanged versions. The male connectors provide space for labelling and can be coded.

General ordering data

Type	SLD 3.50 V/20/180F 3.2 ...	Version	Product data	Packaging
Order No.	1641280000	PCB plug-in connector, male header, Flange, THT solder connection,	IEC: 200 V / 10.5 A	Box
GTIN (EAN)	4008190279684	3.50 mm, Number of poles: 20, 180°, Solder pin length (l): 3.2 mm,	UL: 300 V / 8 A	
Qty.	20 pc(s).	tinned, orange, Box		

**OMNIMATE Signal - series BL/SL 3.50
BL 3.50/10/270 SN OR BX**

Weidmüller Interface GmbH & Co. KG
 Klingenbergstraße 26
 D-32758 Detmold
 Germany
 Fon: +49 5231 14-0
 Fax: +49 5231 14-292083
 www.weidmueller.com

Mating connector (conditionally pluggable)**SL-SMT 3.5/90LF Box**

High-temperature-resistant male header, 3.50 mm pitch.

- **Plugging direction parallel (90°), straight 180° or angled (135°) to PCB**
- **Housing variants: closed side (G), screw flange (F), solder flange (LF) or snap-on solder flange (RF)**
- **Optimised for the SMT process**
- **Pin length 3.2 mm universal for all soldering methods**
- **Pin length 1.5 mm optimised for reflow soldering methods**
- **Packed either in a box (BX) or tape-on-reel (RL)**
- **Male header can be coded**

General ordering data

Type	SL-SMT 3.50/10/90LF 3.2 ...	Version	Product data	Packaging
Order No.	1841940000	PCB plug-in connector, male header, Solder flange, THT/THR solder	IEC: 320 V / 15 A	Box
GTIN (EAN)	4032248353293	connection, 3.50 mm, Number of poles: 10, 90°, Solder pin length (l):	UL: 300 V / 10 A	
Qty.	42 pc(s).	3.2 mm, tinned, black, Box		
Type	SL-SMT 3.50/10/90LF 1.5 ...	Version	Product data	Packaging
Order No.	1805020000	PCB plug-in connector, male header, Solder flange, THT/THR solder	IEC: 320 V / 15 A	Box
GTIN (EAN)	4032248268924	connection, 3.50 mm, Number of poles: 10, 90°, Solder pin length (l):	UL: 300 V / 10 A	
Qty.	42 pc(s).	1.5 mm, tinned, black, Box		

SL-SMT 3.5/180F Box

High-temperature-resistant male header, 3.50 mm pitch.

- **Plugging direction parallel (90°), straight 180° or angled (135°) to PCB**
- **Housing variants: closed side (G), screw flange (F), solder flange (LF) or snap-on solder flange (RF)**
- **Optimised for the SMT process**
- **Pin length 3.2 mm universal for all soldering methods**
- **Pin length 1.5 mm optimised for reflow soldering methods**
- **Packed either in a box (BX) or tape-on-reel (RL)**
- **Male header can be coded**

General ordering data

Type	SL-SMT 3.50/10/180F 3.2 ...	Version	Product data	Packaging
Order No.	1842850000	PCB plug-in connector, male header, Flange, THT/THR solder	IEC: 320 V / 15 A	Box
GTIN (EAN)	4032248354313	connection, 3.50 mm, Number of poles: 10, 180°, Solder pin length	UL: 300 V / 10 A	
Qty.	42 pc(s).	(l): 3.2 mm, tinned, black, Box		

Creation date May 3, 2020 5:33:07 PM CEST

**OMNIMATE Signal - series BL/SL 3.50
BL 3.50/10/270 SN OR BX**

Weidmüller Interface GmbH & Co. KG
Klingenbergstraße 26
D-32758 Detmold
Germany
Fon: +49 5231 14-0
Fax: +49 5231 14-292083
www.weidmueller.com

Mating connector (conditionally pluggable)

Type	SL-SMT 3.50/10/180F 1.5 ...	Version	Product data	Packaging
Order No.	1761042001	PCB plug-in connector, male header, Flange, THT/THR solder connection, 3.50 mm, Number of poles: 10, 180°, Solder pin length (l): 1.5 mm, tinned, black, Box	IEC: 320 V / 15 A UL: 300 V / 10 A	Box
GTIN (EAN)	4032248131617			
Qty.	42 pc(s).			
Type	SL-SMT 3.50/10/180F 1.5 ...	Version	Product data	Packaging
Order No.	1761043001	PCB plug-in connector, male header, Flange, THT/THR solder connection, 3.50 mm, Number of poles: 10, 180°, Solder pin length (l): 1.5 mm, tinned, black, Tray	IEC: 320 V / 15 A UL: 300 V / 10 A	Tray
GTIN (EAN)	4032248133420			
Qty.	36 pc(s).			

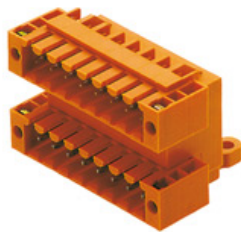
SLD 3.50/90F

Two-tier pin header for wave soldering in 3.50 mm pitch. The connector is available in open, closed and flange versions. The male connectors provide space for labelling and can be coded. Packed in a cardboard box.

General ordering data

Type	SLD 3.50/20/90F 3.2SN O ...	Version	Product data	Packaging
Order No.	1633890000	PCB plug-in connector, male header, Flange, THT solder connection, 3.50 mm, Number of poles: 20, 90°, Solder pin length (l): 3.2 mm, tinned, orange, Box	IEC: 200 V / 10.5 A UL: 300 V / 8 A	Box
GTIN (EAN)	4008190258344			
Qty.	20 pc(s).			

SLD 3.50V/90F

Double-level, staggered pin header for wave soldering at 3.50 mm pitch. They are available in closed and flanged versions. The male connectors provide space for labelling and can be coded.

General ordering data

Type	SLD 3.50 V/20/90F 3.2 S ...	Version	Product data	Packaging
Order No.	1642410000	PCB plug-in connector, male header, Flange, THT solder connection, 3.50 mm, Number of poles: 20, 90°, Solder pin length (l): 3.2 mm, tinned, orange, Box	IEC: 200 V / 10.5 A UL: 300 V / 8 A	Box
GTIN (EAN)	4008190280932			
Qty.	20 pc(s).			

**OMNIMATE Signal - series BL/SL 3.50
BL 3.50/10/270 SN OR BX**

Weidmüller Interface GmbH & Co. KG
Klingenbergstraße 26
D-32758 Detmold
Germany
Fon: +49 5231 14-0
Fax: +49 5231 14-292083
www.weidmuller.com

Mating connector (conditionally pluggable)**SL-SMT 3.5/180G Box**

High-temperature-resistant male header, 3.50 mm pitch.

- **Plugging direction parallel (90°), straight 180° or angled (135°) to PCB**
- **Housing variants: closed side (G), screw flange (F), solder flange (LF) or snap-on solder flange (RF)**
- **Optimised for the SMT process**
- **Pin length 3.2 mm universal for all soldering methods**
- **Pin length 1.5 mm optimised for reflow soldering methods**
- **Packed either in a box (BX) or tape-on-reel (RL)**
- **Male header can be coded**

General ordering data

Type	SL-SMT 3.50/10/180G 1.5 ...	Version	Product data	Packaging
Order No.	1753062001	PCB plug-in connector, male header, closed side, THT/THR solder connection, 3.50 mm, Number of poles: 10, 180°, Solder pin length (l): 1.5 mm, tinned, black, Box	IEC: 320 V / 15 A UL: 300 V / 10 A	Box
GTIN (EAN)	4032248130962			
Qty.	50 pc(s).			
Type	SL-SMT 3.50/10/180G 3.2 ...	Version	Product data	Packaging
Order No.	1836990000	PCB plug-in connector, male header, closed side, THT/THR solder connection, 3.50 mm, Number of poles: 10, 180°, Solder pin length (l): 3.2 mm, tinned, black, Box	IEC: 320 V / 15 A UL: 300 V / 10 A	Box
GTIN (EAN)	4032248345076			
Qty.	50 pc(s).			

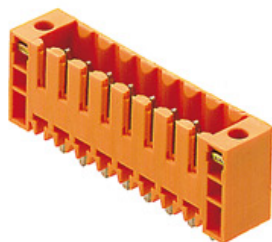
SL 3.50/180F

Pin headers for wave soldering in 3.50 mm pitch

- **Plugging direction is parallel (90°), straight 180° or angled (135°) to the PCB**
- **Housing variant: screw flange (F)**
- **Packed in a cardboard box (BX)**
- **Pin header can be coded**

General ordering data

Type	SL 3.50/10/180F 4.5SN O ...	Version	Product data	Packaging
Order No.	1618760000	PCB plug-in connector, male header, Flange, THT solder connection, 3.50 mm, Number of poles: 10, 180°, Solder pin length (l): 4.5 mm, tinned, orange, Box	IEC: 320 V / 17 A UL: 300 V / 10 A	Box
GTIN (EAN)	4008190127473			
Qty.	50 pc(s).			
Type	SL 3.50/10/180F 3.2SN G ...	Version	Product data	Packaging
Order No.	1622340000	PCB plug-in connector, male header, Flange, THT solder connection, 3.50 mm, Number of poles: 10, 180°, Solder pin length (l): 3.2 mm, tinned, Pebble grey, Box	IEC: 320 V / 17 A UL: 300 V / 10 A	Box
GTIN (EAN)	4008190190040			
Qty.	50 pc(s).			

OMNIMATE Signal - series BL/SL 3.50 BL 3.50/10/270 SN OR BX

Weidmüller Interface GmbH & Co. KG
 Klingenbergstraße 26
 D-32758 Detmold
 Germany
 Fon: +49 5231 14-0
 Fax: +49 5231 14-292083
 www.weidmueller.com

Mating connector (conditionally pluggable)

Type	SL 3.50/10/180F 3.2SN O ...	Version	Product data	Packaging
Order No.	1607580000	PCB plug-in connector, male header, Flange, THT solder connection,	IEC: 320 V / 17 A	Box
GTIN (EAN)	4008190187545	3.50 mm, Number of poles: 10, 180°, Solder pin length (l): 3.2 mm,	UL: 300 V / 10 A	
Qty.	50 pc(s).	tinned, orange, Box		
Type	SL 3.50/10/180F 3.2SN D ...	Version	Product data	Packaging
Order No.	1622560000	PCB plug-in connector, male header, Flange, THT solder connection,	IEC: 320 V / 17 A	Box
GTIN (EAN)	4008190193225	3.50 mm, Number of poles: 10, 180°, Solder pin length (l): 3.2 mm,	UL: 300 V / 10 A	
Qty.	50 pc(s).	tinned, Signal green, Box		
Type	SL 3.50/10/180F 4.5 SN ...	Version	Product data	Packaging
Order No.	1616210000	PCB plug-in connector, male header, Flange, THT solder connection,	IEC: 320 V / 17 A	Box
GTIN (EAN)	4008190068929	3.50 mm, Number of poles: 10, 180°, Solder pin length (l): 4.5 mm,	UL: 300 V / 10 A	
Qty.	50 pc(s).	tinned, black, Box		

SL-SMT 3.5/90F Box



High-temperature-resistant male header, 3.50 mm pitch.

- **Plugging direction parallel (90°), straight 180° or angled (135°) to PCB**
- **Housing variants: closed side (G), screw flange (F), solder flange (LF) or snap-on solder flange (RF)**
- **Optimised for the SMT process**
- **Pin length 3.2 mm universal for all soldering methods**
- **Pin length 1.5 mm optimised for reflow soldering methods**
- **Packed either in a box (BX) or tape-on-reel (RL)**
- **Male header can be coded**

General ordering data

Type	SL-SMT 3.50/10/90F 1.5S ...	Version	Product data	Packaging
Order No.	1762082001	PCB plug-in connector, male header, Flange, THT/THR solder	IEC: 320 V / 15 A	Box
GTIN (EAN)	4032248132492	connection, 3.50 mm, Number of poles: 10, 90°, Solder pin length (l):	UL: 300 V / 10 A	
Qty.	42 pc(s).	1.5 mm, tinned, black, Box		
Type	SL-SMT 3.50/10/90F 3.2S ...	Version	Product data	Packaging
Order No.	1842160000	PCB plug-in connector, male header, Flange, THT/THR solder	IEC: 320 V / 15 A	Box
GTIN (EAN)	4032248353514	connection, 3.50 mm, Number of poles: 10, 90°, Solder pin length (l):	UL: 300 V / 10 A	
Qty.	42 pc(s).	3.2 mm, tinned, black, Box		

OMNIMATE Signal - series BL/SL 3.50
BL 3.50/10/270 SN OR BX

Weidmüller Interface GmbH & Co. KG
 Klingenbergstraße 26
 D-32758 Detmold
 Germany
 Fon: +49 5231 14-0
 Fax: +49 5231 14-292083
 www.weidmueller.com

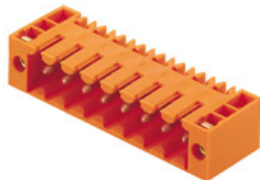
Mating connector (conditionally pluggable)
SL 3.50/90F

Pin headers for wave soldering in 3.50 mm pitch

- Plugging direction is parallel (90°), straight 180° or angled (135°) to the PCB
- Housing variant: screw flange (F)
- Packed in a cardboard box (BX)
- Pin header can be coded

General ordering data

Type	SL 3.50/10/90F 3.2SN OR ...	Version	Product data	Packaging
Order No.	1607120000	PCB plug-in connector, male header, Flange, THT solder connection,	IEC: / 17 A	Box
GTIN (EAN)	4008190079710	3.50 mm, Number of poles: 10, 90°, Solder pin length (l): 3.2 mm,	UL: 300 V / 10 A	
Qty.	50 pc(s).	tinned, orange, Box		
Type	SL 3.50/10/90F 4.5SN OR ...	Version	Product data	Packaging
Order No.	1618130000	PCB plug-in connector, male header, Flange, THT solder connection,	IEC: / 17 A	Box
GTIN (EAN)	4008190116941	3.50 mm, Number of poles: 10, 90°, Solder pin length (l): 4.5 mm,	UL: 300 V / 10 A	
Qty.	50 pc(s).	tinned, orange, Box		
Type	SL 3.50/10/90F 4.5 SN B ...	Version	Product data	Packaging
Order No.	1615600000	PCB plug-in connector, male header, Flange, THT solder connection,	IEC: / 17 A	Box
GTIN (EAN)	4008190057633	3.50 mm, Number of poles: 10, 90°, Solder pin length (l): 4.5 mm,	UL: 300 V / 10 A	
Qty.	50 pc(s).	tinned, black, Box		
Type	SL 3.50/10/90F 3.2SN BK ...	Version	Product data	Packaging
Order No.	1681720000	PCB plug-in connector, male header, Flange, THT solder connection,	IEC: / 17 A	Box
GTIN (EAN)	4008190472528	3.50 mm, Number of poles: 10, 90°, Solder pin length (l): 3.2 mm,	UL: 300 V / 10 A	
Qty.	50 pc(s).	tinned, black, Box		
Type	SL 3.50/10/90F 3.2SN DK ...	Version	Product data	Packaging
Order No.	1620140000	PCB plug-in connector, male header, Flange, THT solder connection,	IEC: / 17 A	Box
GTIN (EAN)	4008190152437	3.50 mm, Number of poles: 10, 90°, Solder pin length (l): 3.2 mm,	UL: 300 V / 10 A	
Qty.	50 pc(s).	tinned, Signal green, Box		
Type	SL 3.50/10/90F 3.2SN GY ...	Version	Product data	Packaging
Order No.	1619930000	PCB plug-in connector, male header, Flange, THT solder connection,	IEC: / 17 A	Box
GTIN (EAN)	4008190149222	3.50 mm, Number of poles: 10, 90°, Solder pin length (l): 3.2 mm,	UL: 300 V / 10 A	
Qty.	50 pc(s).	tinned, Pebble grey, Box		

**OMNIMATE Signal - series BL/SL 3.50
BL 3.50/10/270 SN OR BX**

Weidmüller Interface GmbH & Co. KG
Klingenbergstraße 26
D-32758 Detmold
Germany
Fon: +49 5231 14-0
Fax: +49 5231 14-292083
www.weidmueller.com

Mating connector (conditionally pluggable)
SL-SMT 3.5/180LF Box

High-temperature-resistant male header, 3.50 mm pitch.

- **Plugging direction parallel (90°), straight 180° or angled (135°) to PCB**
- **Housing variants: closed side (G), screw flange (F), solder flange (LF) or snap-on solder flange (RF)**
- **Optimised for the SMT process**
- **Pin length 3.2 mm universal for all soldering methods**
- **Pin length 1.5 mm optimised for reflow soldering methods**
- **Packed either in a box (BX) or tape-on-reel (RL)**
- **Male header can be coded**

General ordering data

Type	SL-SMT 3.50/10/180LF 1. ...	Version	Product data	Packaging
Order No.	1804780000	PCB plug-in connector, male header, Solder flange, THT/THR solder connection, 3.50 mm, Number of poles: 10, 180°, Solder pin length (l): 1.5 mm, tinned, black, Box	IEC: 320 V / 15 A UL: 300 V / 10 A	Box
GTIN (EAN)	4032248268566			
Qty.	42 pc(s).			
Type	SL-SMT 3.50/10/180LF 3. ...	Version	Product data	Packaging
Order No.	1842620000	PCB plug-in connector, male header, Solder flange, THT/THR solder connection, 3.50 mm, Number of poles: 10, 180°, Solder pin length (l): 3.2 mm, tinned, black, Box	IEC: 320 V / 15 A UL: 300 V / 10 A	Box
GTIN (EAN)	4032248353989			
Qty.	42 pc(s).			

**OMNIMATE Signal - series BL/SL 3.50
BL 3.50/10/270 SN OR BX**

Weidmüller Interface GmbH & Co. KG
Klingenbergstraße 26
D-32758 Detmold
Germany
Fon: +49 5231 14-0
Fax: +49 5231 14-292083
www.weidmueller.com

Mating connector (conditionally pluggable)

SL-SMT 3.5/90LF Tape



High-temperature-resistant male header, 3.50 mm pitch.

- **Plugging direction parallel (90°), straight 180° or angled (135°) to PCB**
- **Housing variants: closed side (G), screw flange (F), solder flange (LF) or snap-on solder flange (RF)**
- **Optimised for the SMT process**
- **Pin length 3.2 mm universal for all soldering methods**
- **Pin length 1.5 mm optimised for reflow soldering methods**
- **Packed either in a box (BX) or tape-on-reel (RL)**
- **Male header can be coded**

General ordering data

Type	SL-SMT 3.50/10/90LF 1.5 ...	Version	Product data	Packaging
Order No.	1005180000	PCB plug-in connector, male header, Solder flange, THT/THR solder connection, 3.50 mm, Number of poles: 10, 90°, Solder pin length (l): 1.5 mm, tinned, black, Tape	IEC: 320 V / 15 A UL: 300 V / 10 A	Tape
GTIN (EAN)	4032248704545			
Qty.	385 pc(s).			

OMNIMATE Signal - series BL/SL 3.50
BL 3.50/10/270 SN OR BX

Weidmüller Interface GmbH & Co. KG
 Klingenbergstraße 26
 D-32758 Detmold
 Germany
 Fon: +49 5231 14-0
 Fax: +49 5231 14-292083
 www.weidmueller.com

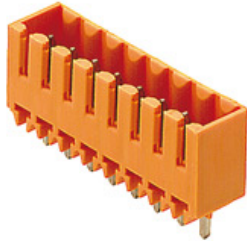
Mating connector (fully pluggable)**SL 3.50/180G**

Pin headers for wave soldering in 3.50 mm pitch

- Plugging direction is parallel (90°), straight 180° or angled (135°) to the PCB
- Housing variant: screw flange (F)
- Packed in a cardboard box (BX)
- Pin header can be coded

General ordering data

Type	SL 3.50/10/180G 3.2SN O ...	Version	Product data	Packaging
Order No.	1604550000	PCB plug-in connector, male header, closed side, THT solder	IEC: 320 V / 17 A	Box
GTIN (EAN)	4008190111663	connection, 3.50 mm, Number of poles: 10, 180°, Solder pin length	UL: 300 V / 10 A	
Qty.	50 pc(s).	(I): 3.2 mm, tinned, orange, Box		
Type	SL 3.50/10/180G 4.5SN O ...	Version	Product data	Packaging
Order No.	1604700000	PCB plug-in connector, male header, closed side, THT solder	IEC: 320 V / 17 A	Box
GTIN (EAN)	4008190058616	connection, 3.50 mm, Number of poles: 10, 180°, Solder pin length	UL: 300 V / 10 A	
Qty.	50 pc(s).	(I): 4.5 mm, tinned, orange, Box		
Type	SL 3.50/10/180G 4.5SN B ...	Version	Product data	Packaging
Order No.	1616080000	PCB plug-in connector, male header, closed side, THT solder	IEC: 320 V / 17 A	Box
GTIN (EAN)	4008190065973	connection, 3.50 mm, Number of poles: 10, 180°, Solder pin length	UL: 300 V / 10 A	
Qty.	50 pc(s).	(I): 4.5 mm, tinned, black, Box		

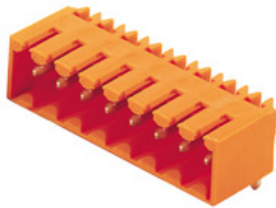
SL 3.50/90G

Pin headers for wave soldering in 3.50 mm pitch

- Plugging direction is parallel (90°), straight 180° or angled (135°) to the PCB
- Housing variant: screw flange (F)
- Packed in a cardboard box (BX)
- Pin header can be coded

General ordering data

Type	SL 3.50/12/90G 3.2SN DK ...	Version	Product data	Packaging
Order No.	1744190000	PCB plug-in connector, male header, closed side, THT solder	IEC: / 17 A	Box
GTIN (EAN)	4008190981716	connection, 3.50 mm, Number of poles: 12, 90°, Solder pin length (I):	UL: 300 V / 10 A	
Qty.	50 pc(s).	3.2 mm, tinned, Signal green, Box		
Type	SL 3.50/10/90G 3.2SN OR ...	Version	Product data	Packaging
Order No.	1605150000	PCB plug-in connector, male header, closed side, THT solder	IEC: / 17 A	Box
GTIN (EAN)	4008190183998	connection, 3.50 mm, Number of poles: 10, 90°, Solder pin length (I):	UL: 300 V / 10 A	
Qty.	50 pc(s).	3.2 mm, tinned, orange, Box		
Type	SL 3.50/10/90G 3.2SN GY ...	Version	Product data	Packaging
Order No.	1619540000	PCB plug-in connector, male header, closed side, THT solder	IEC: / 17 A	Box
GTIN (EAN)	4008190142254	connection, 3.50 mm, Number of poles: 10, 90°, Solder pin length (I):	UL: 300 V / 10 A	
Qty.	50 pc(s).	3.2 mm, tinned, Pebble grey, Box		

**OMNIMATE Signal - series BL/SL 3.50
BL 3.50/10/270 SN OR BX**

Weidmüller Interface GmbH & Co. KG
Klingenbergstraße 26
D-32758 Detmold
Germany
Fon: +49 5231 14-0
Fax: +49 5231 14-292083
www.weidmueller.com

Mating connector (fully pluggable)

Type	SL 3.50/10/90G 3.2SN BK ...	Version	Product data	Packaging
Order No.	1689780000	PCB plug-in connector, male header, closed side, THT solder	IEC: / 17 A	Box
GTIN (EAN)	4008190860738	connection, 3.50 mm, Number of poles: 10, 90°, Solder pin length (l):	UL: 300 V / 10 A	
Qty.	50 pc(s).	3.2 mm, tinned, black, Box		
Type	SL 3.50/10/90G 3.2SN DK ...	Version	Product data	Packaging
Order No.	1606970000	PCB plug-in connector, male header, closed side, THT solder	IEC: / 17 A	Box
GTIN (EAN)	4008190075095	connection, 3.50 mm, Number of poles: 10, 90°, Solder pin length (l):	UL: 300 V / 10 A	
Qty.	50 pc(s).	3.2 mm, tinned, Signal green, Box		
Type	SL 3.50/10/90G 4.5 SN O ...	Version	Product data	Packaging
Order No.	1605300000	PCB plug-in connector, male header, closed side, THT solder	IEC: / 17 A	Box
GTIN (EAN)	4008190101411	connection, 3.50 mm, Number of poles: 10, 90°, Solder pin length (l):	UL: 300 V / 10 A	
Qty.	50 pc(s).	4.5 mm, tinned, orange, Box		
Type	SL 3.50/10/90G 4.5SN BK ...	Version	Product data	Packaging
Order No.	1615470000	PCB plug-in connector, male header, closed side, THT solder	IEC: / 17 A	Box
GTIN (EAN)	4008190055677	connection, 3.50 mm, Number of poles: 10, 90°, Solder pin length (l):	UL: 300 V / 10 A	
Qty.	50 pc(s).	4.5 mm, tinned, black, Box		

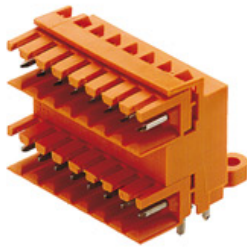
SLD 3.50/90

Two-tier pin header for wave soldering in 3.50 mm pitch. The connector is available in open, closed and flange versions. The male connectors provide space for labelling and can be coded. Packed in a cardboard box.

General ordering data

Type	SLD 3.50/20/90 3.2SN OR ...	Version	Product data	Packaging
Order No.	1633430000	PCB plug-in connector, male header, open side, THT solder	IEC: 200 V / 10.5 A	Box
GTIN (EAN)	4008190257880	connection, 3.50 mm, Number of poles: 20, 90°, Solder pin length (l):	UL: 300 V / 8 A	
Qty.	20 pc(s).	3.2 mm, tinned, orange, Box		

OMNIMATE Signal - series BL/SL 3.50 BL 3.50/10/270 SN OR BX

Weidmüller Interface GmbH & Co. KG
 Klingenbergstraße 26
 D-32758 Detmold
 Germany
 Fon: +49 5231 14-0
 Fax: +49 5231 14-292083
 www.weidmueller.com

Mating connector (fully pluggable)

SL-SMT 3.5/90G Tray



High-temperature-resistant male header, 3.50 mm pitch.

- **Plugging direction parallel (90°), straight 180° or angled (135°) to PCB**
- **Housing variants: closed side (G), screw flange (F), solder flange (LF) or snap-on solder flange (RF)**
- **Optimised for the SMT process**
- **Pin length 3.2 mm universal for all soldering methods**
- **Pin length 1.5 mm optimised for reflow soldering methods**
- **Packed either in a box (BX) or tape-on-reel (RL)**
- **Male header can be coded**

General ordering data

Type	SL-SMT 3.50/10/90G 1.5S ...	Version	Product data	Packaging
Order No.	1761623001	PCB plug-in connector, male header, closed side, THT/THR solder connection, 3.50 mm, Number of poles: 10, 90°, Solder pin length (l): 1.5 mm, tinned, black, Tray	IEC: 320 V / 15 A	Tray
GTIN (EAN)	4032248133895		UL: 300 V / 10 A	
Qty.	42 pc(s).			

SL-SMT 3.5/90G Tape



High-temperature-resistant male header, 3.50 mm pitch.

- **Plugging direction parallel (90°), straight 180° or angled (135°) to PCB**
- **Housing variants: closed side (G), screw flange (F), solder flange (LF) or snap-on solder flange (RF)**
- **Optimised for the SMT process**
- **Pin length 3.2 mm universal for all soldering methods**
- **Pin length 1.5 mm optimised for reflow soldering methods**
- **Packed either in a box (BX) or tape-on-reel (RL)**
- **Male header can be coded**

General ordering data

Type	SL-SMT 3.50/10/90G 1.5S ...	Version	Product data	Packaging
Order No.	1761624001	PCB plug-in connector, male header, closed side, THT/THR solder connection, 3.50 mm, Number of poles: 10, 90°, Solder pin length (l): 1.5 mm, tinned, black, Tape	IEC: 320 V / 15 A	Tape
GTIN (EAN)	4032248136063		UL: 300 V / 10 A	
Qty.	385 pc(s).			

**OMNIMATE Signal - series BL/SL 3.50
BL 3.50/10/270 SN OR BX**

Weidmüller Interface GmbH & Co. KG
Klingenbergstraße 26
D-32758 Detmold
Germany
Fon: +49 5231 14-0
Fax: +49 5231 14-292083
www.weidmueller.com

Mating connector (fully pluggable)
SL-THR 3.5/135F

High-temperature-resistant male header, 3.50 mm pitch.

- **Plugging direction parallel (90°), straight 180° or angled (135°) to PCB**
- **Housing variants: closed side (G), screw flange (F), solder flange (LF) or snap-on solder flange (RF)**
- **Optimised for the SMT process**
- **Pin length 3.2 mm universal for all soldering methods**
- **Pin length 1.5 mm optimised for reflow soldering methods**
- **Packed either in a box (BX) or tape-on-reel (RL)**
- **Male header can be coded**

General ordering data

Type	SL-SMT 3.50/10/135F 3.2 ...	Version	Product data	Packaging
Order No.	1003590000	PCB plug-in connector, male header, Flange, THT/THR solder connection, 3.50 mm, Number of poles: 10, 135°, Solder pin length (l): 3.2 mm, tinned, black, Box	IEC: 320 V / 15 A UL: 300 V / 10 A	Box
GTIN (EAN)	4032248700219			
Qty.	42 pc(s).			

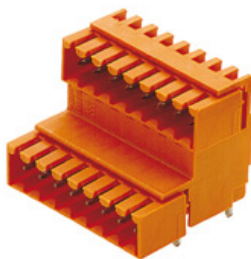
SLD 3.50V/90G

Double-level, staggered pin header for wave soldering at 3.50 mm pitch. They are available in closed and flanged versions. The male connectors provide space for labelling and can be coded.

General ordering data

Type	SLD 3.50V/20/90G 3.2SN ...	Version	Product data	Packaging
Order No.	1642280000	PCB plug-in connector, male header, closed side, THT solder connection, 3.50 mm, Number of poles: 20, 90°, Solder pin length (l): 3.2 mm, tinned, orange, Box	IEC: 200 V / 10.5 A UL: 300 V / 8 A	Box
GTIN (EAN)	4008190280802			
Qty.	20 pc(s).			

**OMNIMATE Signal - series BL/SL 3.50
BL 3.50/10/270 SN OR BX**

Weidmüller Interface GmbH & Co. KG
Klingenbergstraße 26
D-32758 Detmold
Germany
Fon: +49 5231 14-0
Fax: +49 5231 14-292083
www.weidmueller.com

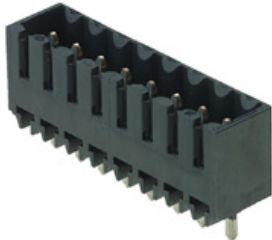
Mating connector (fully pluggable)
SL-SMT 3.5/180G Tape

High-temperature-resistant male header, 3.50 mm pitch.

- **Plugging direction parallel (90°), straight 180° or angled (135°) to PCB**
- **Housing variants: closed side (G), screw flange (F), solder flange (LF) or snap-on solder flange (RF)**
- **Optimised for the SMT process**
- **Pin length 3.2 mm universal for all soldering methods**
- **Pin length 1.5 mm optimised for reflow soldering methods**
- **Packed either in a box (BX) or tape-on-reel (RL)**
- **Male header can be coded**

General ordering data

Type	SL-SMT 3.50/10/180G 1.5 ...	Version	Product data	Packaging
Order No.	1753064001	PCB plug-in connector, male header, closed side, THT/THR solder connection, 3.50 mm, Number of poles: 10, 180°, Solder pin length (l): 1.5 mm, tinned, black, Tape	IEC: 320 V / 15 A UL: 300 V / 10 A	Tape
GTIN (EAN)	4032248135660			
Qty.	265 pc(s).			

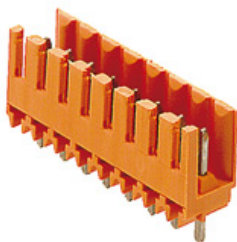
SL 3.50/180

Pin headers for wave soldering in 3.50 mm pitch

- **Plugging direction is parallel (90°), straight 180° or angled (135°) to the PCB**
- **Housing variant: screw flange (F)**
- **Packed in a cardboard box (BX)**
- **Pin header can be coded**

General ordering data

Type	SL 3.50/10/180 3.2SN OR ...	Version	Product data	Packaging
Order No.	1604850000	PCB plug-in connector, male header, open side, THT solder connection, 3.50 mm, Number of poles: 10, 180°, Solder pin length (l): 3.2 mm, tinned, orange, Box	IEC: 320 V / 17 A UL: 300 V / 10 A	Box
GTIN (EAN)	4008190096649			
Qty.	50 pc(s).			

**OMNIMATE Signal - series BL/SL 3.50
BL 3.50/10/270 SN OR BX**

Weidmüller Interface GmbH & Co. KG
Klingenbergstraße 26
D-32758 Detmold
Germany
Fon: +49 5231 14-0
Fax: +49 5231 14-292083
www.weidmuller.com

Mating connector (fully pluggable)
SL-SMT 3.5/180G Tray

High-temperature-resistant male header, 3.50 mm pitch.

- **Plugging direction parallel (90°), straight 180° or angled (135°) to PCB**
- **Housing variants: closed side (G), screw flange (F), solder flange (LF) or snap-on solder flange (RF)**
- **Optimised for the SMT process**
- **Pin length 3.2 mm universal for all soldering methods**
- **Pin length 1.5 mm optimised for reflow soldering methods**
- **Packed either in a box (BX) or tape-on-reel (RL)**
- **Male header can be coded**

General ordering data

Type	SL-SMT 3.50/10/180G 1.5 ...	Version	Product data	Packaging
Order No.	1753063001	PCB plug-in connector, male header, closed side, THT/THR solder connection, 3.50 mm, Number of poles: 10, 180°, Solder pin length (l): 1.5 mm, tinned, black, Tray	IEC: 320 V / 15 A UL: 300 V / 10 A	Tray
GTIN (EAN)	4032248132799			
Qty.	42 pc(s).			

SL-SMT 3.5/90G Box

High-temperature-resistant male header, 3.50 mm pitch.

- **Plugging direction parallel (90°), straight 180° or angled (135°) to PCB**
- **Housing variants: closed side (G), screw flange (F), solder flange (LF) or snap-on solder flange (RF)**
- **Optimised for the SMT process**
- **Pin length 3.2 mm universal for all soldering methods**
- **Pin length 1.5 mm optimised for reflow soldering methods**
- **Packed either in a box (BX) or tape-on-reel (RL)**
- **Male header can be coded**

General ordering data

Type	SL-SMT 3.50/10/90G 1.5S ...	Version	Product data	Packaging
Order No.	1761622001	PCB plug-in connector, male header, closed side, THT/THR solder connection, 3.50 mm, Number of poles: 10, 90°, Solder pin length (l): 1.5 mm, tinned, black, Box	IEC: 320 V / 15 A UL: 300 V / 10 A	Box
GTIN (EAN)	4032248132218			
Qty.	50 pc(s).			

**OMNIMATE Signal - series BL/SL 3.50
BL 3.50/10/270 SN OR BX**

Weidmüller Interface GmbH & Co. KG
Klingenbergstraße 26
D-32758 Detmold
Germany
Fon: +49 5231 14-0
Fax: +49 5231 14-292083
www.weidmueller.com

Mating connector (fully pluggable)

Type	SL-SMT 3.50/10/90G 3.2S ...	Version	Product data	Packaging
Order No.	1841710000	PCB plug-in connector, male header, closed side, THT/THR solder	IEC: 320 V / 15 A	Box
GTIN (EAN)	4032248353064	connection, 3.50 mm, Number of poles: 10, 90°, Solder pin length (l):	UL: 300 V / 10 A	
Qty.	50 pc(s).	3.2 mm, tinned, black, Box		

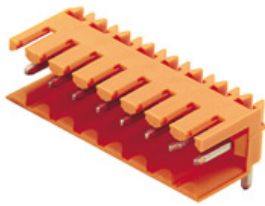
SL 3.50/90

Pin headers for wave soldering in 3.50 mm pitch

- Plugging direction is parallel (90°), straight 180° or angled (135°) to the PCB
- Housing variant: screw flange (F)
- Packed in a cardboard box (BX)
- Pin header can be coded

General ordering data

Type	SL 3.50/10/90 3.2SN OR ...	Version	Product data	Packaging
Order No.	1597290000	PCB plug-in connector, male header, open side, THT solder	IEC: 320 V / 17 A	Box
GTIN (EAN)	4008190165277	connection, 3.50 mm, Number of poles: 10, 90°, Solder pin length (l):	UL: 300 V / 10 A	
Qty.	50 pc(s).	3.2 mm, tinned, orange, Box		
Type	SL 3.50/10/90 3.2SN GY ...	Version	Product data	Packaging
Order No.	1619150000	PCB plug-in connector, male header, open side, THT solder	IEC: 320 V / 17 A	Box
GTIN (EAN)	4008190134709	connection, 3.50 mm, Number of poles: 10, 90°, Solder pin length (l):	UL: 300 V / 10 A	
Qty.	50 pc(s).	3.2 mm, tinned, Pebble grey, Box		
Type	SL 3.50/10/90 4.5SN OR ...	Version	Product data	Packaging
Order No.	1605450000	PCB plug-in connector, male header, open side, THT solder	IEC: 320 V / 17 A	Box
GTIN (EAN)	4008190138363	connection, 3.50 mm, Number of poles: 10, 90°, Solder pin length (l):	UL: 300 V / 10 A	
Qty.	50 pc(s).	4.5 mm, tinned, orange, Box		
Type	SL 3.50/10/90 4.5SN BK ...	Version	Product data	Packaging
Order No.	1615360000	PCB plug-in connector, male header, open side, THT solder	IEC: 320 V / 17 A	Box
GTIN (EAN)	4008190053024	connection, 3.50 mm, Number of poles: 10, 90°, Solder pin length (l):	UL: 300 V / 10 A	
Qty.	50 pc(s).	4.5 mm, tinned, black, Box		
Type	SL 3.50/10/90 3.2SN DKG ...	Version	Product data	Packaging
Order No.	1606850000	PCB plug-in connector, male header, open side, THT solder	IEC: 320 V / 17 A	Box
GTIN (EAN)	4008190154721	connection, 3.50 mm, Number of poles: 10, 90°, Solder pin length (l):	UL: 300 V / 10 A	
Qty.	50 pc(s).	3.2 mm, tinned, Signal green, Box		
Type	SL 3.50/10/90 3.2SN BK ...	Version	Product data	Packaging
Order No.	1663790000	PCB plug-in connector, male header, open side, THT solder	IEC: 320 V / 17 A	Box
GTIN (EAN)	4008190420475	connection, 3.50 mm, Number of poles: 10, 90°, Solder pin length (l):	UL: 300 V / 10 A	
Qty.	50 pc(s).	3.2 mm, tinned, black, Box		

**OMNIMATE Signal - series BL/SL 3.50
BL 3.50/10/270 SN OR BX**

Weidmüller Interface GmbH & Co. KG
Klingenbergstraße 26
D-32758 Detmold
Germany
Fon: +49 5231 14-0
Fax: +49 5231 14-292083
www.weidmueller.com

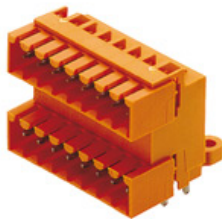
Mating connector (fully pluggable)
SLD 3.50/90G

Two-tier pin header for wave soldering in 3.50 mm pitch. The connector is available in open, closed and flange versions. The male connectors provide space for labelling and can be coded. Packed in a cardboard box.

General ordering data

Type	SLD 3.50/20/90G 3.2SN D ...	Version	Product data	Packaging
Order No.	1674940000	PCB plug-in connector, male header, closed side, THT solder connection, 3.50 mm, Number of poles: 20, 90°, Solder pin length (l): 3.2 mm, tinned, Signal green, Box	IEC: 200 V / 10.5 A UL: 300 V / 8 A	Box
GTIN (EAN)	4008190445638			
Qty.	20 pc(s).			
Type	SLD 3.50/20/90G 3.2SN O ...	Version	Product data	Packaging
Order No.	1633660000	PCB plug-in connector, male header, closed side, THT solder connection, 3.50 mm, Number of poles: 20, 90°, Solder pin length (l): 3.2 mm, tinned, orange, Box	IEC: 200 V / 10.5 A UL: 300 V / 8 A	Box
GTIN (EAN)	4008190258115			
Qty.	20 pc(s).			
Type	SLD 3.50/20/90G 4.5SN B ...	Version	Product data	Packaging
Order No.	1634350000	PCB plug-in connector, male header, closed side, THT solder connection, 3.50 mm, Number of poles: 20, 90°, Solder pin length (l): 4.5 mm, tinned, black, Box	IEC: 200 V / 10.5 A UL: 300 V / 8 A	Box
GTIN (EAN)	4008190258801			
Qty.	20 pc(s).			

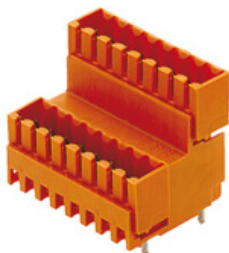
SLD 3.50V/180G

Double-level, staggered pin header for wave soldering at 3.50 mm pitch. They are available in closed and flanged versions. The male connectors provide space for labelling and can be coded.

General ordering data

Type	SLD 3.50V/20/180G 3.2SN ...	Version	Product data	Packaging
Order No.	1641150000	PCB plug-in connector, male header, closed side, THT solder connection, 3.50 mm, Number of poles: 20, 180°, Solder pin length (l): 3.2 mm, tinned, orange, Box	IEC: 200 V / 10.5 A UL: 300 V / 8 A	Box
GTIN (EAN)	4008190279554			
Qty.	20 pc(s).			

OMNIMATE Signal - series BL/SL 3.50 BL 3.50/10/270 SN OR BX

Weidmüller Interface GmbH & Co. KG
 Klingenbergstraße 26
 D-32758 Detmold
 Germany
 Fon: +49 5231 14-0
 Fax: +49 5231 14-292083
 www.weidmueller.com

Accessories

Coding elements



**Only connects what is supposed to be connected:
the right connection at the right place.**

Coding elements and locking devices clearly assign connecting elements during the manufacturing process and operation

The coding elements and locking devices are inserted prior to assembly or during the cable assembly phase. The Weidmüller alternative: configure online using the variant configurator to precode prior to delivery.

Incorrect assembly on the circuit board and incorrect plugging of connecting elements is no longer possible. The advantage: no troubleshooting during manufacture and no operational errors by the user.

General ordering data

Type	BL SL 3.5 KO SW	Version	Product data	Packaging
Order No.	1610100000	PCB plug-in connector, Accessories, Coding element, black, Number		Box
GTIN (EAN)	4008190187637	of poles: 1		
Qty.	100 pc(s).			
Type	BL SL 3.5 KO OR	Version	Product data	Packaging
Order No.	1693430000	PCB plug-in connector, Accessories, Coding element, orange, Number		Box
GTIN (EAN)	4008190867447	of poles: 1		
Qty.	100 pc(s).			

WEITERGABE SOWIE VERVIELFÄLTIGUNG DIESES DOKUMENTS, VERWERTUNG UND MITTEILUNG SEINES INHALTS SIND VERBOTEN, SOWEIT NICHT AUSDRUECKLICH GESTATTET.
 ZUWIDERHANDLUNGEN VERPFLICHTEN ZU SCHADENERSATZ. ALLE RECHTE FUER DEN FALL DER PATENT-, GEBRAUCHSMUSTER- ODER GESCHMACKSMUSTEREINTRAGUNG VORBEHALTEN.
 THE REPRODUCTION, DISTRIBUTION AND UTILIZATION OF THIS DOCUMENT AS WELL AS THE COMMUNICATION OF ITS CONTENTS TO OTHERS WITHOUT EXPLICIT AUTHORIZATION IS PROHIBITED.
 OFFENDERS WILL BE HELD LIABLE FOR THE PAYMENT OF DAMAGES. WEIDMUELLER EXCLUSIVELY RESERVES THE RIGHT TO FILE FOR PATENTS, UTILITY MODELS OR DESIGNS.

© WEIDMUELLER INTERFACE GmbH & Co.KG

DIE DEUTSCHE VERSION IST VERBINDLICH
THE GERMAN VERSION IS BINDING

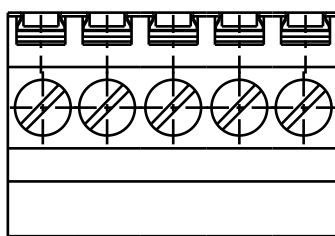
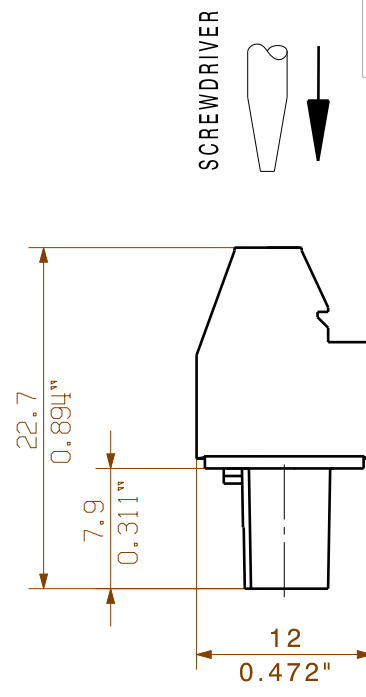
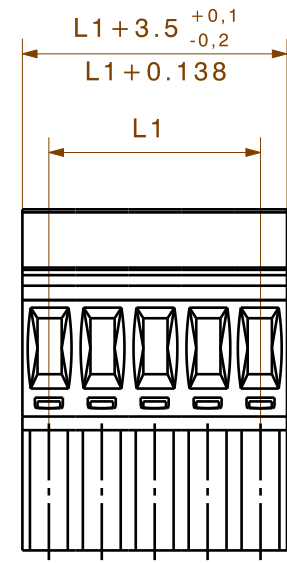

24	80,50	3,169
23	77,00	3,031
22	73,50	2,894
21	70,00	2,756
20	66,50	2,618
19	63,00	2,480
18	59,50	2,343
17	56,00	2,205
16	52,50	2,067
15	49,00	1,929
14	45,50	1,791
13	42,00	1,654
12	38,50	1,516
11	35,00	1,378
10	31,50	1,240
9	28,00	1,102
8	24,50	0,965
7	21,00	0,827
6	17,50	0,689
5	14,00	0,551
4	10,50	0,413
3	7,00	0,276
2	3,50	0,138
n	L1[mm]	L1 [Inch]

For the mounting of PCBs, it should be noted that the rated data stated here relates only to the PCB components alone.
 The necessary creepage and clearance paths must be observed in connection with the respective applicant in accordance to IEC 664 / VDE 0110.
 The current-carrying capacity and pitch tolerance is to be determined according to DIN IEC 326 part 3 very fine.

Weidmüller PCB components are tested to the DIN EN 61984 standard, and are valid for its field of application.
 Provided that the components are used to the intended purpose, all requirements with respect to the occurring of electrical, mechanical, thermic and corrosive stress will be satisfied.

SHOWN : BL3.50/05/270

	DIN ISO 2768-m		CAT.NO.: .	
	74368/5	15.04.14 HELIS_MA	01	
			C 21347 09 <small>DRAWING NO. ISSUE NO.</small>	
MODIFICATION			SHEET 01 OF 02 SHEETS	
	DATE	NAME	BL 3.50/.../270... BUCHSENLEISTE SOCKET BLOCK	
	DRAWN	24.07.2003 KOWOLLIK_R		
RESPONSIBLE	LANG_T			
CHECKED	15.04.2014 THELEN_E			
SCALE: 5/1	CHECKED	15.04.2014 THELEN_E	APPROVED	HECKERT_M
SUPERSEDES: .	APPROVED	HECKERT_M	PRODUCT FILE: BL 3.50 90/270	
			7368	