

## OMNIMATE Signal - series BL/SL 3.50 BL 3.50/12/90F SN BK BX

**Weidmüller Interface GmbH & Co. KG**  
Klingenbergstraße 26  
D-32758 Detmold  
Germany  
Fon: +49 5231 14-0  
Fax: +49 5231 14-292083  
www.weidmueller.com

### Product image

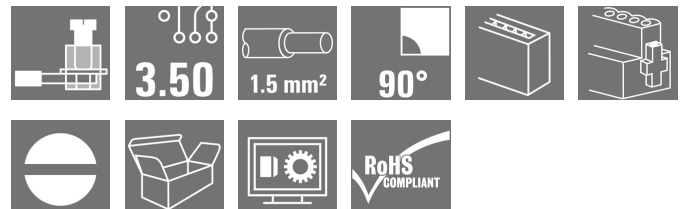

Similar to illustration

Female connectors with clamping yoke screw system for connecting conductors at 3.50 mm pitch. They provide space for labelling and can be coded.

### General ordering data

Type	BL 3.50/12/90F SN BK BX
Order No.	<a href="#">1639340000</a>
Version	PCB plug-in connector, female plug, 3.50 mm, Number of poles: 12, 90°, Clamping yoke connection, Clamping range, max. : 1.5 mm², Box
GTIN (EAN)	4008190276881
Qty.	36 pc(s).
Product data	IEC: 320 V / 12 A / 0.2 - 1.5 mm² UL: 300 V / 8 A / AWG 28 - AWG 14
Packaging	Box

Creation date May 3, 2020 5:36:57 PM CEST

**OMNIMATE Signal - series BL/SL 3.50  
BL 3.50/12/90F SN BK BX**

**Weidmüller Interface GmbH & Co. KG**  
 Klingenbergstraße 26  
 D-32758 Detmold  
 Germany  
 Fon: +49 5231 14-0  
 Fax: +49 5231 14-292083  
 www.weidmueller.com

**Technical data****Dimensions and weights**

Width	49 mm	Width (inches)	1.929 inch
Height	12 mm	Height (inches)	0.472 inch
Depth	22.45 mm	Depth (inches)	0.884 inch
Net weight	12.88 g		

**System Parameters**

Product family	OMNIMATE Signal - series BL/SL 3.50	Type of connection	Field connection
Wire connection method	Clamping yoke connection	Pitch in mm (P)	3.5 mm
Pitch in inches (P)	0.138 inch	Conductor outlet direction	90°
Number of poles	12	L1 in mm	38.5 mm
L1 in inches	1.516 inch	Number of rows	1
Pin series quantity	1	Rated cross-section	1.5 mm <sup>2</sup>
Touch-safe protection acc. to DIN VDE 57 106	Safe from finger touch	Touch-safe protection acc. to DIN VDE 0470	IP 20
Volume resistance	≤ 5mΩ	Can be coded	Yes
Stripping length	6 mm	Tightening torque for screw flange, min.	0.15 Nm
Tightening torque for screw flange, max.	0.2 Nm	Tightening torque, min.	0.2 Nm
Tightening torque, max.	0.25 Nm	Clamping screw	M 2
Screwdriver blade	0.4 x 2.5	Screwdriver blade standard	DIN 5264
Plugging cycles	25	Plugging force/pole, max.	7 N
Pulling force/pole, max.	5 N		

**Material data**

Insulating material	PBT	Colour	black
Colour chart (similar)	RAL 9011	Insulating material group	IIIa
Comparative Tracking Index (CTI)	≥ 200	Insulation strength	≥ 10 <sup>8</sup> Ω
UL 94 flammability rating	V-0	GWFI	960 °C
Contact material	Copper alloy	Contact surface	tinned
Layer structure of plug contact	4-8 μm Sn hot-dip tinned	Storage temperature, min.	-25 °C
Storage temperature, max.	50 °C	Max. relative humidity during storage	70 %
Operating temperature, min.	-50 °C	Operating temperature, max.	100 °C
Temperature range, installation, min.	-30 °C	Temperature range, installation, max.	100 °C

**Conductors suitable for connection**

Clamping range, min.	0.08 mm <sup>2</sup>
Clamping range, max.	1.5 mm <sup>2</sup>
Wire connection cross section AWG, min.	AWG 28
Wire connection cross section AWG, max.	AWG 14
Solid, min. H05(07) V-U	0.2 mm <sup>2</sup>
Solid, max. H05(07) V-U	1.5 mm <sup>2</sup>
Flexible, min. H05(07) V-K	0.2 mm <sup>2</sup>
Flexible, max. H05(07) V-K	1.5 mm <sup>2</sup>
w. plastic collar ferrule, DIN 46228 pt 4, 0.2 mm <sup>2</sup> min.	
w. plastic collar ferrule, DIN 46228 pt 4, 1.5 mm <sup>2</sup> max.	
w. wire end ferrule, DIN 46228 pt 1, min.	0.2 mm <sup>2</sup>
w. wire end ferrule, DIN 46228 pt 1, max.	1.5 mm <sup>2</sup>

Creation date May 3, 2020 5:36:57 PM CEST

**OMNIMATE Signal - series BL/SL 3.50**  
**BL 3.50/12/90F SN BK BX**

**Weidmüller Interface GmbH & Co. KG**  
 Klingenbergstraße 26  
 D-32758 Detmold  
 Germany  
 Fon: +49 5231 14-0  
 Fax: +49 5231 14-292083  
 www.weidmueller.com

**Technical data**

Plug gauge in accordance with EN 60999 a x b; ø 2.4 mm x 1.5 mm

Clampable conductor	Cross-section for conductor connection	Type	fine-wired
		nominal	0.5 mm <sup>2</sup>
wire end ferrule	Stripping length	nominal	8 mm
		Recommended wire-end ferrule	<a href="#">H0.5/12 OR</a>
		nominal	6 mm
		Recommended wire-end ferrule	<a href="#">H0.5/6</a>
Cross-section for conductor connection	Type	fine-wired	
	nominal	0.75 mm <sup>2</sup>	
wire end ferrule	Stripping length	nominal	8 mm
		Recommended wire-end ferrule	<a href="#">H0.75/12 W</a>
		nominal	6 mm
		Recommended wire-end ferrule	<a href="#">H0.75/6</a>
Cross-section for conductor connection	Type	fine-wired	
	nominal	1 mm <sup>2</sup>	
wire end ferrule	Stripping length	nominal	8 mm
		Recommended wire-end ferrule	<a href="#">H1.0/12 GE</a>
		nominal	6 mm
		Recommended wire-end ferrule	<a href="#">H1.0/6</a>
Cross-section for conductor connection	Type	fine-wired	
	nominal	0.25 mm <sup>2</sup>	
wire end ferrule	Stripping length	nominal	8 mm
		Recommended wire-end ferrule	<a href="#">H0.25/10 HBL</a>
		nominal	5 mm
		Recommended wire-end ferrule	<a href="#">H0.25/5</a>
Cross-section for conductor connection	Type	fine-wired	
	nominal	0.34 mm <sup>2</sup>	
wire end ferrule	Stripping length	nominal	8 mm
	Recommended wire-end ferrule	<a href="#">H0.34/10 TK</a>	

Reference text The outside diameter of the plastic collar should not be larger than the pitch (P). Length of ferrules is to be chosen depending on the product and the rated voltage.

Max. clamping range 1.5 mm<sup>2</sup>

**Rated data acc. to IEC**

tested acc. to standard	IEC 60664-1, IEC 61984	Rated current, min. number of poles (Tu=20°C)	12 A
Rated current, max. number of poles (Tu=20°C)	10 A	Rated current, min. number of poles (Tu=40°C)	10 A
Rated current, max. number of poles (Tu=40°C)	8 A	Rated voltage for surge voltage class / pollution degree II/2	320 V
Rated voltage for surge voltage class / pollution degree III/2	160 V	Rated voltage for surge voltage class / pollution degree III/3	160 V
Rated impulse voltage for surge voltage class/ pollution degree II/2	2.5 kV	Rated impulse voltage for surge voltage class/ pollution degree III/2	2.5 kV
Rated impulse voltage for surge voltage class/ contamination degree III/3	2.5 kV	Short-time withstand current resistance	3 x 1s with 100 A

**OMNIMATE Signal - series BL/SL 3.50  
BL 3.50/12/90F SN BK BX**

**Weidmüller Interface GmbH & Co. KG**  
 Klingenbergstraße 26  
 D-32758 Detmold  
 Germany  
 Fon: +49 5231 14-0  
 Fax: +49 5231 14-292083  
 www.weidmueller.com

**Technical data****Rated data acc. to CSA**

Institute (CSA)



Certificate No. (CSA)

154685-1318353

Rated voltage (Use group B / CSA)	300 V
Rated current (Use group B / CSA)	10 A
Wire cross-section, AWG, min.	AWG 28
Reference to approval values	Specifications are maximum values, details - see approval certificate.

Rated voltage (Use group D / CSA)	300 V
Rated current (Use group D / CSA)	10 A
Wire cross-section, AWG, max.	AWG 14

**Rated data acc. to UL 1059**

Institute (UR)



Certificate No. (UR)

E60693

Rated voltage (Use group B / UL 1059)	300 V
Rated current (Use group B / UL 1059)	8 A
Wire cross-section, AWG, min.	AWG 28
Reference to approval values	Specifications are maximum values, details - see approval certificate.

Rated voltage (Use group D / UL 1059)	300 V
Rated current (Use group D / UL 1059)	8 A
Wire cross-section, AWG, max.	AWG 14

**Packing**

Packaging	Box	VPE length	77 mm
VPE width	95 mm	VPE height	140 mm

**Classifications**

ETIM 6.0	EC002638	ETIM 7.0	EC002638
eClass 9.0	27-44-03-09	eClass 9.1	27-44-03-09
eClass 10.0	27-44-03-09	UNSPSC	30-21-18-10

**Data sheet**

**OMNIMATE Signal - series BL/SL 3.50  
BL 3.50/12/90F SN BK BX**

**Weidmüller Interface GmbH & Co. KG**  
Klingenbergstraße 26  
D-32758 Detmold  
Germany  
Fon: +49 5231 14-0  
Fax: +49 5231 14-292083  
www.weidmueller.com

**Technical data**

**Notes**

Notes	<ul style="list-style-type: none"> <li>• Additional colours on request</li> <li>• Gold-plated contact surfaces on request</li> <li>• Rated current related to rated cross-section &amp; min. No. of poles.</li> <li>• Max. outer diameter of the conductor: 2.9 mm</li> <li>• Wire end ferrule without plastic collar to DIN 46228/1</li> <li>• Wire end ferrule with plastic collar to DIN 46228/4</li> <li>• P on drawing = pitch</li> <li>• Rated data refer only to the component itself. Clearance and creepage distances to other components are to be designed in accordance with the relevant application standards.</li> </ul>
IPC conformity	Conformity: The products are developed, manufactured and delivered according international recognized standards and norms and comply with the assured properties in the data sheet resp. fulfill decorative properties in accordance with IPC-A-610 "Class 2". Further claims on the products can be evaluated on request.

**Approvals**

Approvals



ROHS Conform

**Downloads**

Approval/Certificate/Document of Conformity	<a href="#">Declaration of the Manufacturer</a>
Brochure/Catalogue	<a href="#">FL DRIVES EN</a> <a href="#">MB DEVICE MANUF. EN</a> <a href="#">FL DRIVES DE</a> <a href="#">CAT 2 PORTFOLIOGUIDE EN</a> <a href="#">FL BUILDING SAFETY EN</a> <a href="#">FL APPL LED LIGHTING EN</a> <a href="#">FLIndustr.CONTROLS EN</a> <a href="#">FL MACHINE SAFETY EN</a> <a href="#">FL HEATING ELECTR EN</a> <a href="#">FL APPL INVERTER EN</a> <a href="#">FL_BASE_STATION_EN</a> <a href="#">FL ELEVATOR EN</a> <a href="#">FL POWER SUPPLY EN</a> <a href="#">FL 72H SAMPLE SER EN</a> <a href="#">PO OMNIMATE EN</a>
Engineering Data	<a href="#">EPLAN.WSCAD</a>
Engineering Data	<a href="#">STEP</a>

**OMNIMATE Signal - series BL/SL 3.50  
BL 3.50/12/90F SN BK BX**

**Weidmüller Interface GmbH & Co. KG**  
Klingenbergstraße 26  
D-32758 Detmold  
Germany  
Fon: +49 5231 14-0  
Fax: +49 5231 14-292083  
www.weidmueller.com

**Drawings**

**Dimensional drawing**

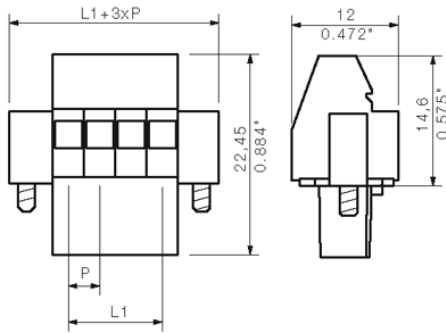

**Graph**

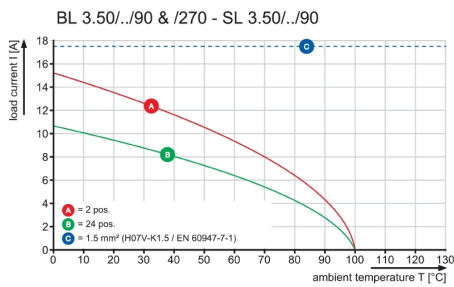

**Graph**

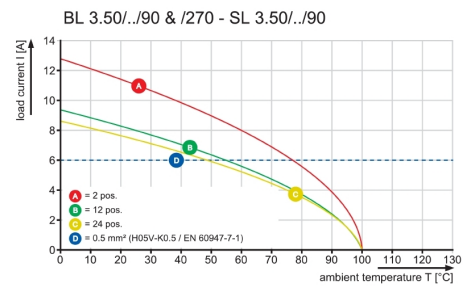

**OMNIMATE Signal - series BL/SL 3.50  
BL 3.50/12/90F SN BK BX**

**Weidmüller Interface GmbH & Co. KG**  
Klingenbergstraße 26  
D-32758 Detmold  
Germany  
Fon: +49 5231 14-0  
Fax: +49 5231 14-292083  
www.weidmueller.com

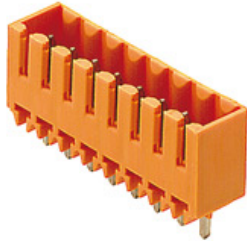
**Mating connector (conditionally pluggable)**
**SL 3.50/180G**

Pin headers for wave soldering in 3.50 mm pitch

- Plugging direction is parallel (90°), straight 180° or angled (135°) to the PCB
- Housing variant: screw flange (F)
- Packed in a cardboard box (BX)
- Pin header can be coded

**General ordering data**

Type	SL 3.50/12/180G 3.2SN O ...	Version	Product data	Packaging
Order No.	<a href="#">1604570000</a>	PCB plug-in connector, male header, closed side, THT solder connection, 3.50 mm, Number of poles: 12, 180°, Solder pin length (l): 3.2 mm, tinned, orange, Box	IEC: 320 V / 17 A UL: 300 V / 10 A	Box
GTIN (EAN)	4008190031572			
Qty.	50 pc(s).			
Type	SL 3.50/12/180G 4.5SN B ...	Version	Product data	Packaging
Order No.	<a href="#">1616100000</a>	PCB plug-in connector, male header, closed side, THT solder connection, 3.50 mm, Number of poles: 12, 180°, Solder pin length (l): 4.5 mm, tinned, black, Box	IEC: 320 V / 17 A UL: 300 V / 10 A	Box
GTIN (EAN)	4008190067489			
Qty.	50 pc(s).			

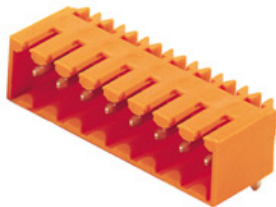
**SL 3.50/90G**

Pin headers for wave soldering in 3.50 mm pitch

- Plugging direction is parallel (90°), straight 180° or angled (135°) to the PCB
- Housing variant: screw flange (F)
- Packed in a cardboard box (BX)
- Pin header can be coded

**General ordering data**

Type	SL 3.50/12/90G 3.2SN DK ...	Version	Product data	Packaging
Order No.	<a href="#">1606990000</a>	PCB plug-in connector, male header, closed side, THT solder connection, 3.50 mm, Number of poles: 12, 90°, Solder pin length (l): 3.2 mm, tinned, Signal green, Box	IEC: / 17 A UL: 300 V / 10 A	Box
GTIN (EAN)	4008190065928			
Qty.	50 pc(s).			
Type	SL 3.50/12/90G 4.5SN OR ...	Version	Product data	Packaging
Order No.	<a href="#">1605320000</a>	PCB plug-in connector, male header, closed side, THT solder connection, 3.50 mm, Number of poles: 12, 90°, Solder pin length (l): 4.5 mm, tinned, orange, Box	IEC: / 17 A UL: 300 V / 10 A	Box
GTIN (EAN)	4008190041632			
Qty.	50 pc(s).			
Type	SL 3.50/12/90G 4.5SN BK ...	Version	Product data	Packaging
Order No.	<a href="#">1615490000</a>	PCB plug-in connector, male header, closed side, THT solder connection, 3.50 mm, Number of poles: 12, 90°, Solder pin length (l): 4.5 mm, tinned, black, Box	IEC: / 17 A UL: 300 V / 10 A	Box
GTIN (EAN)	4008190056025			
Qty.	50 pc(s).			
Type	SL 3.50/12/90G 3.2SN OR ...	Version	Product data	Packaging
Order No.	<a href="#">1605170000</a>	PCB plug-in connector, male header, closed side, THT solder connection, 3.50 mm, Number of poles: 12, 90°, Solder pin length (l): 3.2 mm, tinned, orange, Box	IEC: / 17 A UL: 300 V / 10 A	Box
GTIN (EAN)	4008190096342			
Qty.	50 pc(s).			

## OMNIMATE Signal - series BL/SL 3.50 BL 3.50/12/90F SN BK BX

**Weidmüller Interface GmbH & Co. KG**  
Klingenbergstraße 26  
D-32758 Detmold  
Germany  
Fon: +49 5231 14-0  
Fax: +49 5231 14-292083  
www.weidmueller.com

### Mating connector (conditionally pluggable)

Type	SL 3.50/12/90G 3.2SN GY ...	Version	Product data	Packaging
Order No.	<a href="#">1619560000</a>	PCB plug-in connector, male header, closed side, THT solder	IEC: / 17 A	Box
GTIN (EAN)	4008190142551	connection, 3.50 mm, Number of poles: 12, 90°, Solder pin length (!):	UL: 300 V / 10 A	
Qty.	50 pc(s).	3.2 mm, tinned, Pebble grey, Box		

### SLD 3.50/90

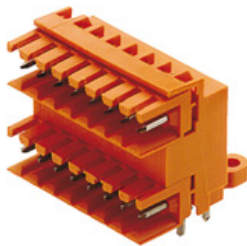

Two-tier pin header for wave soldering in 3.50 mm pitch. The connector is available in open, closed and flange versions. The male connectors provide space for labelling and can be coded. Packed in a cardboard box.

#### General ordering data

Type	SLD 3.50/24/90 3.2SN OR ...	Version	Product data	Packaging
Order No.	<a href="#">1633450000</a>	PCB plug-in connector, male header, open side, THT solder	IEC: 200 V / 10.5 A	Box
GTIN (EAN)	4008190257903	connection, 3.50 mm, Number of poles: 24, 90°, Solder pin length (!):	UL: 300 V / 8 A	
Qty.	10 pc(s).	3.2 mm, tinned, orange, Box		

### SL-SMT 3.5/90G Tray



**High-temperature-resistant male header, 3.50 mm pitch.**

- **Plugging direction parallel (90°), straight 180° or angled (135°) to PCB**
- **Housing variants: closed side (G), screw flange (F), solder flange (LF) or snap-on solder flange (RF)**
- **Optimised for the SMT process**
- **Pin length 3.2 mm universal for all soldering methods**
- **Pin length 1.5 mm optimised for reflow soldering methods**
- **Packed either in a box (BX) or tape-on-reel (RL)**
- **Male header can be coded**

#### General ordering data

Type	SL-SMT 3.50/12/90G 1.5S ...	Version	Product data	Packaging
Order No.	<a href="#">1761643001</a>	PCB plug-in connector, male header, closed side, THT/THR solder	IEC: 320 V / 15 A	Tray
GTIN (EAN)	4032248133918	connection, 3.50 mm, Number of poles: 12, 90°, Solder pin length (!):	UL: 300 V / 10 A	
Qty.	36 pc(s).	1.5 mm, tinned, black, Tray		



**OMNIMATE Signal - series BL/SL 3.50  
BL 3.50/12/90F SN BK BX**

**Weidmüller Interface GmbH & Co. KG**  
Klingenbergstraße 26  
D-32758 Detmold  
Germany  
Fon: +49 5231 14-0  
Fax: +49 5231 14-292083  
www.weidmueller.com

**Mating connector (conditionally pluggable)**
**SL-THR 3.5/135F**

**High-temperature-resistant male header, 3.50 mm pitch.**

- **Plugging direction parallel (90°), straight 180° or angled (135°) to PCB**
- **Housing variants: closed side (G), screw flange (F), solder flange (LF) or snap-on solder flange (RF)**
- **Optimised for the SMT process**
- **Pin length 3.2 mm universal for all soldering methods**
- **Pin length 1.5 mm optimised for reflow soldering methods**
- **Packed either in a box (BX) or tape-on-reel (RL)**
- **Male header can be coded**

**General ordering data**

Type	SL-SMT 3.50/12/135F 3.2 ...	Version	Product data	Packaging
Order No.	<a href="#">1003620000</a>	PCB plug-in connector, male header, Flange, THT/THR solder connection, 3.50 mm, Number of poles: 12, 135°, Solder pin length (l): 3.2 mm, tinned, black, Box	IEC: 320 V / 15 A UL: 300 V / 10 A	Box
GTIN (EAN)	4032248700240			
Qty.	36 pc(s).			

**SLD 3.50V/90G**

Double-level, staggered pin header for wave soldering at 3.50 mm pitch. They are available in closed and flanged versions. The male connectors provide space for labelling and can be coded.

**General ordering data**

Type	SLD 3.50V/24/90G 3.2SN ...	Version	Product data	Packaging
Order No.	<a href="#">1642290000</a>	PCB plug-in connector, male header, closed side, THT solder connection, 3.50 mm, Number of poles: 24, 90°, Solder pin length (l): 3.2 mm, tinned, orange, Box	IEC: 200 V / 10.5 A UL: 300 V / 8 A	Box
GTIN (EAN)	4008190280819			
Qty.	10 pc(s).			

**OMNIMATE Signal - series BL/SL 3.50  
BL 3.50/12/90F SN BK BX**

**Weidmüller Interface GmbH & Co. KG**  
Klingenbergstraße 26  
D-32758 Detmold  
Germany  
Fon: +49 5231 14-0  
Fax: +49 5231 14-292083  
www.weidmueller.com

**Mating connector (conditionally pluggable)**
**SL-SMT 3.5/180G Box**

**High-temperature-resistant male header, 3.50 mm pitch.**

- **Plugging direction parallel (90°), straight 180° or angled (135°) to PCB**
- **Housing variants: closed side (G), screw flange (F), solder flange (LF) or snap-on solder flange (RF)**
- **Optimised for the SMT process**
- **Pin length 3.2 mm universal for all soldering methods**
- **Pin length 1.5 mm optimised for reflow soldering methods**
- **Packed either in a box (BX) or tape-on-reel (RL)**
- **Male header can be coded**

**General ordering data**

Type	SL-SMT 3.50/12/180G 1.5 ...	Version	Product data	Packaging
Order No.	<a href="#">1753082001</a>	PCB plug-in connector, male header, closed side, THT/THR solder connection, 3.50 mm, Number of poles: 12, 180°, Solder pin length (l): 1.5 mm, tinned, black, Box	IEC: 320 V / 15 A UL: 300 V / 10 A	Box
GTIN (EAN)	4032248130986			
Qty.	50 pc(s).			
Type	SL-SMT 3.50/12/180G 3.2 ...	Version	Product data	Packaging
Order No.	<a href="#">1842410000</a>	PCB plug-in connector, male header, closed side, THT/THR solder connection, 3.50 mm, Number of poles: 12, 180°, Solder pin length (l): 3.2 mm, tinned, black, Box	IEC: 320 V / 15 A UL: 300 V / 10 A	Box
GTIN (EAN)	4032248353767			
Qty.	50 pc(s).			

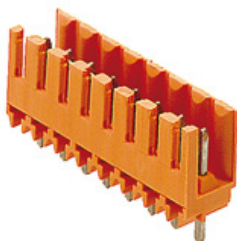
**SL 3.50/180**

Pin headers for wave soldering in 3.50 mm pitch

- **Plugging direction is parallel (90°), straight 180° or angled (135°) to the PCB**
- **Housing variant: screw flange (F)**
- **Packed in a cardboard box (BX)**
- **Pin header can be coded**

**General ordering data**

Type	SL 3.50/12/180 3.2SN OR ...	Version	Product data	Packaging
Order No.	<a href="#">1604870000</a>	PCB plug-in connector, male header, open side, THT solder connection, 3.50 mm, Number of poles: 12, 180°, Solder pin length (l): 3.2 mm, tinned, orange, Box	IEC: 320 V / 17 A UL: 300 V / 10 A	Box
GTIN (EAN)	4008190111427			
Qty.	50 pc(s).			

**OMNIMATE Signal - series BL/SL 3.50  
BL 3.50/12/90F SN BK BX**

**Weidmüller Interface GmbH & Co. KG**  
Klingenbergstraße 26  
D-32758 Detmold  
Germany  
Fon: +49 5231 14-0  
Fax: +49 5231 14-292083  
www.weidmueller.com

**Mating connector (conditionally pluggable)**
**SL-SMT 3.5/180G Tray**

**High-temperature-resistant male header, 3.50 mm pitch.**

- **Plugging direction parallel (90°), straight 180° or angled (135°) to PCB**
- **Housing variants: closed side (G), screw flange (F), solder flange (LF) or snap-on solder flange (RF)**
- **Optimised for the SMT process**
- **Pin length 3.2 mm universal for all soldering methods**
- **Pin length 1.5 mm optimised for reflow soldering methods**
- **Packed either in a box (BX) or tape-on-reel (RL)**
- **Male header can be coded**

**General ordering data**

Type	SL-SMT 3.50/12/180G 1.5 ...	Version	Product data	Packaging
Order No.	<a href="#">1753083001</a>	PCB plug-in connector, male header, closed side, THT/THR solder connection, 3.50 mm, Number of poles: 12, 180°, Solder pin length (l): 1.5 mm, tinned, black, Tray	IEC: 320 V / 15 A UL: 300 V / 10 A	Tray
GTIN (EAN)	4032248132911			
Qty.	36 pc(s).			

**SL-SMT 3.5/90G Box**

**High-temperature-resistant male header, 3.50 mm pitch.**

- **Plugging direction parallel (90°), straight 180° or angled (135°) to PCB**
- **Housing variants: closed side (G), screw flange (F), solder flange (LF) or snap-on solder flange (RF)**
- **Optimised for the SMT process**
- **Pin length 3.2 mm universal for all soldering methods**
- **Pin length 1.5 mm optimised for reflow soldering methods**
- **Packed either in a box (BX) or tape-on-reel (RL)**
- **Male header can be coded**

**General ordering data**

Type	SL-SMT 3.50/12/90G 1.5S ...	Version	Product data	Packaging
Order No.	<a href="#">1761642001</a>	PCB plug-in connector, male header, closed side, THT/THR solder connection, 3.50 mm, Number of poles: 12, 90°, Solder pin length (l): 1.5 mm, tinned, black, Box	IEC: 320 V / 15 A UL: 300 V / 10 A	Box
GTIN (EAN)	4032248132232			
Qty.	50 pc(s).			

**OMNIMATE Signal - series BL/SL 3.50  
BL 3.50/12/90F SN BK BX**

**Weidmüller Interface GmbH & Co. KG**  
Klingenbergstraße 26  
D-32758 Detmold  
Germany  
Fon: +49 5231 14-0  
Fax: +49 5231 14-292083  
www.weidmueller.com

**Mating connector (conditionally pluggable)**

Type	SL-SMT 3.50/12/90G 3.2S ...	Version	Product data	Packaging
Order No.	<a href="#">1841730000</a>	PCB plug-in connector, male header, closed side, THT/THR solder	IEC: 320 V / 15 A	Box
GTIN (EAN)	4032248353088	connection, 3.50 mm, Number of poles: 12, 90°, Solder pin length (l):	UL: 300 V / 10 A	
Qty.	50 pc(s).	3.2 mm, tinned, black, Box		

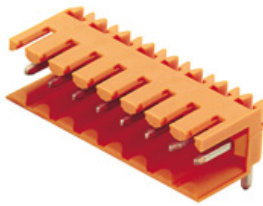
**SL 3.50/90**

Pin headers for wave soldering in 3.50 mm pitch

- Plugging direction is parallel (90°), straight 180° or angled (135°) to the PCB
- Housing variant: screw flange (F)
- Packed in a cardboard box (BX)
- Pin header can be coded

**General ordering data**

Type	SL 3.50/12/90 4.5SN BK ...	Version	Product data	Packaging
Order No.	<a href="#">1615380000</a>	PCB plug-in connector, male header, open side, THT solder	IEC: 320 V / 17 A	Box
GTIN (EAN)	4008190053406	connection, 3.50 mm, Number of poles: 12, 90°, Solder pin length (l):	UL: 300 V / 10 A	
Qty.	50 pc(s).	4.5 mm, tinned, black, Box		
Type	SL 3.50/12/90 3.2SN GY ...	Version	Product data	Packaging
Order No.	<a href="#">1619170000</a>	PCB plug-in connector, male header, open side, THT solder	IEC: 320 V / 17 A	Box
GTIN (EAN)	4008190134839	connection, 3.50 mm, Number of poles: 12, 90°, Solder pin length (l):	UL: 300 V / 10 A	
Qty.	50 pc(s).	3.2 mm, tinned, Pebble grey, Box		
Type	SL 3.50/12/90 3.2SN OR ...	Version	Product data	Packaging
Order No.	<a href="#">1597310000</a>	PCB plug-in connector, male header, open side, THT solder	IEC: 320 V / 17 A	Box
GTIN (EAN)	4008190018283	connection, 3.50 mm, Number of poles: 12, 90°, Solder pin length (l):	UL: 300 V / 10 A	
Qty.	50 pc(s).	3.2 mm, tinned, orange, Box		
Type	SL 3.50/12/90 4.5SN OR ...	Version	Product data	Packaging
Order No.	<a href="#">1605470000</a>	PCB plug-in connector, male header, open side, THT solder	IEC: 320 V / 17 A	Box
GTIN (EAN)	4008190144647	connection, 3.50 mm, Number of poles: 12, 90°, Solder pin length (l):	UL: 300 V / 10 A	
Qty.	50 pc(s).	4.5 mm, tinned, orange, Box		
Type	SL 3.50/12/90 3.2SN DKG ...	Version	Product data	Packaging
Order No.	<a href="#">1606870000</a>	PCB plug-in connector, male header, open side, THT solder	IEC: 320 V / 17 A	Box
GTIN (EAN)	4008190023973	connection, 3.50 mm, Number of poles: 12, 90°, Solder pin length (l):	UL: 300 V / 10 A	
Qty.	50 pc(s).	3.2 mm, tinned, Signal green, Box		

**OMNIMATE Signal - series BL/SL 3.50  
BL 3.50/12/90F SN BK BX**

**Weidmüller Interface GmbH & Co. KG**  
Klingenbergstraße 26  
D-32758 Detmold  
Germany  
Fon: +49 5231 14-0  
Fax: +49 5231 14-292083  
www.weidmueller.com

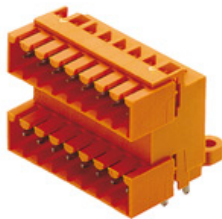
**Mating connector (conditionally pluggable)**
**SLD 3.50/90G**

Two-tier pin header for wave soldering in 3.50 mm pitch. The connector is available in open, closed and flange versions. The male connectors provide space for labelling and can be coded. Packed in a cardboard box.

**General ordering data**

Type	SLD 3.50/24/90G 4.5SN B ...	Version	Product data	Packaging
Order No.	<a href="#">1634370000</a>	PCB plug-in connector, male header, closed side, THT solder connection, 3.50 mm, Number of poles: 24, 90°, Solder pin length (l): 4.5 mm, tinned, black, Box	IEC: 200 V / 10.5 A UL: 300 V / 8 A	Box
GTIN (EAN)	4008190258825			
Qty.	10 pc(s).			
Type	SLD 3.50/24/90G 3.2SN O ...	Version	Product data	Packaging
Order No.	<a href="#">1633680000</a>	PCB plug-in connector, male header, closed side, THT solder connection, 3.50 mm, Number of poles: 24, 90°, Solder pin length (l): 3.2 mm, tinned, orange, Box	IEC: 200 V / 10.5 A UL: 300 V / 8 A	Box
GTIN (EAN)	4008190258139			
Qty.	10 pc(s).			

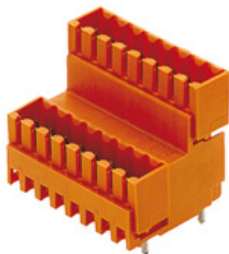
**SLD 3.50V/180G**

Double-level, staggered pin header for wave soldering at 3.50 mm pitch. They are available in closed and flanged versions. The male connectors provide space for labelling and can be coded.

**General ordering data**

Type	SLD 3.50V/24/180G 3.2SN ...	Version	Product data	Packaging
Order No.	<a href="#">1641160000</a>	PCB plug-in connector, male header, closed side, THT solder connection, 3.50 mm, Number of poles: 24, 180°, Solder pin length (l): 3.2 mm, tinned, orange, Box	IEC: 200 V / 10.5 A UL: 300 V / 8 A	Box
GTIN (EAN)	4008190279561			
Qty.	10 pc(s).			

**OMNIMATE Signal - series BL/SL 3.50  
BL 3.50/12/90F SN BK BX**

**Weidmüller Interface GmbH & Co. KG**  
Klingenbergstraße 26  
D-32758 Detmold  
Germany  
Fon: +49 5231 14-0  
Fax: +49 5231 14-292083  
www.weidmueller.com

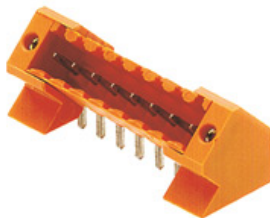
**Mating connector (fully pluggable)**
**SL 3.50/135F**

Pin headers for wave soldering in 3.50 mm pitch

- Plugging direction is parallel (90°), straight 180° or angled (135°) to the PCB
- Housing variant: screw flange (F)
- Packed in a cardboard box (BX)
- Pin header can be coded

**General ordering data**

Type	SL 3.50/12/135F 3.2SN O ...	Version	Product data	Packaging
Order No.	<a href="#">1643430000</a>	PCB plug-in connector, male header, Flange, THT solder connection,	IEC: 320 V / 15 A	Box
GTIN (EAN)	4008190282196	3.50 mm, Number of poles: 12, 135°, Solder pin length (l): 3.2 mm,	UL: 300 V / 10 A	
Qty.	36 pc(s).	tinned, orange, Box		

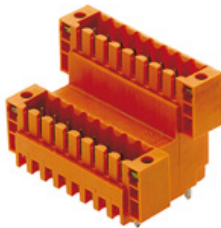
**SLD 3.50V/180F**

Double-level, staggered pin header for wave soldering at 3.50 mm pitch. They are available in closed and flanged versions. The male connectors provide space for labelling and can be coded.

**General ordering data**

Type	SLD 3.50 V/24/180F 3.2 ...	Version	Product data	Packaging
Order No.	<a href="#">1641290000</a>	PCB plug-in connector, male header, Flange, THT solder connection,	IEC: 200 V / 10.5 A	Box
GTIN (EAN)	4008190279691	3.50 mm, Number of poles: 24, 180°, Solder pin length (l): 3.2 mm,	UL: 300 V / 8 A	
Qty.	10 pc(s).	tinned, orange, Box		

## OMNIMATE Signal - series BL/SL 3.50 BL 3.50/12/90F SN BK BX

**Weidmüller Interface GmbH & Co. KG**  
 Klingenbergstraße 26  
 D-32758 Detmold  
 Germany  
 Fon: +49 5231 14-0  
 Fax: +49 5231 14-292083  
 www.weidmueller.com

### Mating connector (fully pluggable)

#### SL-SMT 3.5/90LF Box



**High-temperature-resistant male header, 3.50 mm pitch.**

- **Plugging direction parallel (90°), straight 180° or angled (135°) to PCB**
- **Housing variants: closed side (G), screw flange (F), solder flange (LF) or snap-on solder flange (RF)**
- **Optimised for the SMT process**
- **Pin length 3.2 mm universal for all soldering methods**
- **Pin length 1.5 mm optimised for reflow soldering methods**
- **Packed either in a box (BX) or tape-on-reel (RL)**
- **Male header can be coded**

#### General ordering data

Type	SL-SMT 3.50/12/90LF 3.2 ...	Version	Product data	Packaging
Order No.	<a href="#">1804340000</a>	PCB plug-in connector, male header, Solder flange, THT/THR solder connection, 3.50 mm, Number of poles: 12, 90°, Solder pin length (l): 3.2 mm, tinned, black, Box	IEC: 320 V / 15 A UL: 300 V / 10 A	Box
GTIN (EAN)	4032248288533			
Qty.	36 pc(s).			
Type	SL-SMT 3.50/12/90LF 1.5 ...	Version	Product data	Packaging
Order No.	<a href="#">1805040000</a>	PCB plug-in connector, male header, Solder flange, THT/THR solder connection, 3.50 mm, Number of poles: 12, 90°, Solder pin length (l): 1.5 mm, tinned, black, Box	IEC: 320 V / 15 A UL: 300 V / 10 A	Box
GTIN (EAN)	4032248268948			
Qty.	36 pc(s).			

**OMNIMATE Signal - series BL/SL 3.50  
BL 3.50/12/90F SN BK BX**

**Weidmüller Interface GmbH & Co. KG**  
Klingenbergstraße 26  
D-32758 Detmold  
Germany  
Fon: +49 5231 14-0  
Fax: +49 5231 14-292083  
www.weidmueller.com

**Mating connector (fully pluggable)**
**SL-SMT 3.5/180F Box**

**High-temperature-resistant male header, 3.50 mm pitch.**

- **Plugging direction parallel (90°), straight 180° or angled (135°) to PCB**
- **Housing variants: closed side (G), screw flange (F), solder flange (LF) or snap-on solder flange (RF)**
- **Optimised for the SMT process**
- **Pin length 3.2 mm universal for all soldering methods**
- **Pin length 1.5 mm optimised for reflow soldering methods**
- **Packed either in a box (BX) or tape-on-reel (RL)**
- **Male header can be coded**

**General ordering data**

Type	SL-SMT 3.50/12/180F 3.2 ...	Version	Product data	Packaging
Order No.	<a href="#">1842870000</a>	PCB plug-in connector, male header, Flange, THT/THR solder connection, 3.50 mm, Number of poles: 12, 180°, Solder pin length (l): 3.2 mm, tinned, black, Box	IEC: 320 V / 15 A UL: 300 V / 10 A	Box
GTIN (EAN)	4032248354337			
Qty.	36 pc(s).			

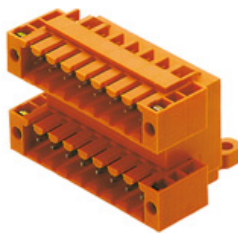
**SLD 3.50/90F**

Two-tier pin header for wave soldering in 3.50 mm pitch. The connector is available in open, closed and flange versions. The male connectors provide space for labelling and can be coded. Packed in a cardboard box.

**General ordering data**

Type	SLD 3.50/24/90F 3.2SN O ...	Version	Product data	Packaging
Order No.	<a href="#">1633910000</a>	PCB plug-in connector, male header, Flange, THT solder connection, 3.50 mm, Number of poles: 24, 90°, Solder pin length (l): 3.2 mm, tinned, orange, Box	IEC: 200 V / 10.5 A UL: 300 V / 8 A	Box
GTIN (EAN)	4008190258368			
Qty.	10 pc(s).			



**OMNIMATE Signal - series BL/SL 3.50  
BL 3.50/12/90F SN BK BX**

**Weidmüller Interface GmbH & Co. KG**  
Klingenbergstraße 26  
D-32758 Detmold  
Germany  
Fon: +49 5231 14-0  
Fax: +49 5231 14-292083  
www.weidmueller.com

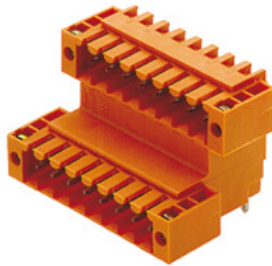
**Mating connector (fully pluggable)**
**SLD 3.50V/90F**

Double-level, staggered pin header for wave soldering at 3.50 mm pitch. They are available in closed and flanged versions. The male connectors provide space for labelling and can be coded.

**General ordering data**

Type	SLD 3.50 V/24/90F 3.2 S ...	Version	Product data	Packaging
Order No.	<a href="#">1642420000</a>	PCB plug-in connector, male header, Flange, THT solder connection,	IEC: 200 V / 10.5 A	Box
GTIN (EAN)	4008190280949	3.50 mm, Number of poles: 24, 90°, Solder pin length (l): 3.2 mm,	UL: 300 V / 8 A	
Qty.	10 pc(s).	tinned, orange, Box		

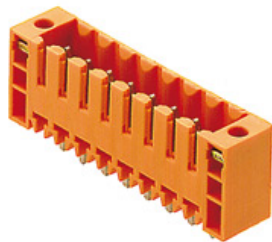
**SL 3.50/180F**

Pin headers for wave soldering in 3.50 mm pitch

- Plugging direction is parallel (90°), straight 180° or angled (135°) to the PCB
- Housing variant: screw flange (F)
- Packed in a cardboard box (BX)
- Pin header can be coded

**General ordering data**

Type	SL 3.50/12/180F 4.5 SN ...	Version	Product data	Packaging
Order No.	<a href="#">1616230000</a>	PCB plug-in connector, male header, Flange, THT solder connection,	IEC: 320 V / 17 A	Box
GTIN (EAN)	4008190069186	3.50 mm, Number of poles: 12, 180°, Solder pin length (l): 4.5 mm,	UL: 300 V / 10 A	
Qty.	50 pc(s).	tinned, black, Box		
Type	SL 3.50/12/180F 3.2SN O ...	Version	Product data	Packaging
Order No.	<a href="#">1607600000</a>	PCB plug-in connector, male header, Flange, THT solder connection,	IEC: 320 V / 17 A	Box
GTIN (EAN)	4008190164935	3.50 mm, Number of poles: 12, 180°, Solder pin length (l): 3.2 mm,	UL: 300 V / 10 A	
Qty.	50 pc(s).	tinned, orange, Box		
Type	SL 3.50/12/180F 3.2SN G ...	Version	Product data	Packaging
Order No.	<a href="#">1622360000</a>	PCB plug-in connector, male header, Flange, THT solder connection,	IEC: 320 V / 17 A	Box
GTIN (EAN)	4008190190064	3.50 mm, Number of poles: 12, 180°, Solder pin length (l): 3.2 mm,	UL: 300 V / 10 A	
Qty.	50 pc(s).	tinned, Pebble grey, Box		
Type	SL 3.50/12/180F 3.2SN D ...	Version	Product data	Packaging
Order No.	<a href="#">1622580000</a>	PCB plug-in connector, male header, Flange, THT solder connection,	IEC: 320 V / 17 A	Box
GTIN (EAN)	4008190193249	3.50 mm, Number of poles: 12, 180°, Solder pin length (l): 3.2 mm,	UL: 300 V / 10 A	
Qty.	50 pc(s).	tinned, Signal green, Box		
Type	SL 3.50/12/180F 4.5SN O ...	Version	Product data	Packaging
Order No.	<a href="#">1618780000</a>	PCB plug-in connector, male header, Flange, THT solder connection,	IEC: 320 V / 17 A	Box
GTIN (EAN)	4008190127602	3.50 mm, Number of poles: 12, 180°, Solder pin length (l): 4.5 mm,	UL: 300 V / 10 A	
Qty.	50 pc(s).	tinned, orange, Box		

## OMNIMATE Signal - series BL/SL 3.50 BL 3.50/12/90F SN BK BX

**Weidmüller Interface GmbH & Co. KG**  
Klingenbergstraße 26  
D-32758 Detmold  
Germany  
Fon: +49 5231 14-0  
Fax: +49 5231 14-292083  
www.weidmueller.com

### Mating connector (fully pluggable)

#### SL-SMT 3.5/90F Box



**High-temperature-resistant male header, 3.50 mm pitch.**

- **Plugging direction parallel (90°), straight 180° or angled (135°) to PCB**
- **Housing variants: closed side (G), screw flange (F), solder flange (LF) or snap-on solder flange (RF)**
- **Optimised for the SMT process**
- **Pin length 3.2 mm universal for all soldering methods**
- **Pin length 1.5 mm optimised for reflow soldering methods**
- **Packed either in a box (BX) or tape-on-reel (RL)**
- **Male header can be coded**

#### General ordering data

Type	SL-SMT 3.50/12/90F 3.2S ...	Version	Product data	Packaging
Order No.	<a href="#">1842180000</a>	PCB plug-in connector, male header, Flange, THT/THR solder connection, 3.50 mm, Number of poles: 12, 90°, Solder pin length (l): 3.2 mm, tinned, black, Box	IEC: 320 V / 15 A UL: 300 V / 10 A	Box
GTIN (EAN)	4032248353538			
Qty.	36 pc(s).			

#### SL 3.50/90F

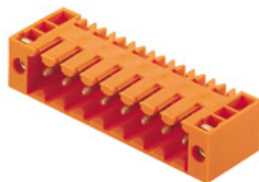

Pin headers for wave soldering in 3.50 mm pitch

- **Plugging direction is parallel (90°), straight 180° or angled (135°) to the PCB**
- **Housing variant: screw flange (F)**
- **Packed in a cardboard box (BX)**
- **Pin header can be coded**

#### General ordering data

Type	SL 3.50/12/90F 3.2SN OR ...	Version	Product data	Packaging
Order No.	<a href="#">1607140000</a>	PCB plug-in connector, male header, Flange, THT solder connection, 3.50 mm, Number of poles: 12, 90°, Solder pin length (l): 3.2 mm, tinned, orange, Box	IEC: / 17 A UL: 300 V / 10 A	Box
GTIN (EAN)	4008190092375			
Qty.	50 pc(s).			
Type	SL 3.50/12/90F 3.2SN GY ...	Version	Product data	Packaging
Order No.	<a href="#">1619950000</a>	PCB plug-in connector, male header, Flange, THT solder connection, 3.50 mm, Number of poles: 12, 90°, Solder pin length (l): 3.2 mm, tinned, Pebble grey, Box	IEC: / 17 A UL: 300 V / 10 A	Box
GTIN (EAN)	4008190149512			
Qty.	50 pc(s).			
Type	SL 3.50/12/90F 3.2SN DK ...	Version	Product data	Packaging
Order No.	<a href="#">1620160000</a>	PCB plug-in connector, male header, Flange, THT solder connection, 3.50 mm, Number of poles: 12, 90°, Solder pin length (l): 3.2 mm, tinned, Signal green, Box	IEC: / 17 A UL: 300 V / 10 A	Box
GTIN (EAN)	4008190152574			
Qty.	50 pc(s).			

## OMNIMATE Signal - series BL/SL 3.50 BL 3.50/12/90F SN BK BX

**Weidmüller Interface GmbH & Co. KG**  
Klingenbergstraße 26  
D-32758 Detmold  
Germany  
Fon: +49 5231 14-0  
Fax: +49 5231 14-292083  
www.weidmueller.com

### Mating connector (fully pluggable)

Type	SL 3.50/12/90F 3.2SN BK ...	Version	Product data	Packaging
Order No.	<a href="#">1694000000</a>	PCB plug-in connector, male header, Flange, THT solder connection,	IEC: / 17 A	Box
GTIN (EAN)	4008190871901	3.50 mm, Number of poles: 12, 90°, Solder pin length (l): 3.2 mm,	UL: 300 V / 10 A	
Qty.	50 pc(s).	tinned, black, Box		
Type	SL 3.50/12/90F 4.5 SN B ...	Version	Product data	Packaging
Order No.	<a href="#">1615620000</a>	PCB plug-in connector, male header, Flange, THT solder connection,	IEC: / 17 A	Box
GTIN (EAN)	4008190057985	3.50 mm, Number of poles: 12, 90°, Solder pin length (l): 4.5 mm,	UL: 300 V / 10 A	
Qty.	50 pc(s).	tinned, black, Box		
Type	SL 3.50/12/90F 4.5SN OR ...	Version	Product data	Packaging
Order No.	<a href="#">1618150000</a>	PCB plug-in connector, male header, Flange, THT solder connection,	IEC: / 17 A	Box
GTIN (EAN)	4008190117078	3.50 mm, Number of poles: 12, 90°, Solder pin length (l): 4.5 mm,	UL: 300 V / 10 A	
Qty.	50 pc(s).	tinned, orange, Box		

### SL-SMT 3.5/180LF Box



**High-temperature-resistant male header, 3.50 mm pitch.**

- **Plugging direction parallel (90°), straight 180° or angled (135°) to PCB**
- **Housing variants: closed side (G), screw flange (F), solder flange (LF) or snap-on solder flange (RF)**
- **Optimised for the SMT process**
- **Pin length 3.2 mm universal for all soldering methods**
- **Pin length 1.5 mm optimised for reflow soldering methods**
- **Packed either in a box (BX) or tape-on-reel (RL)**
- **Male header can be coded**

### General ordering data

Type	SL-SMT 3.50/12/180LF 1. ...	Version	Product data	Packaging
Order No.	<a href="#">1804800000</a>	PCB plug-in connector, male header, Solder flange, THT/THR solder	IEC: 320 V / 15 A	Box
GTIN (EAN)	4032248268580	connection, 3.50 mm, Number of poles: 12, 180°, Solder pin length	UL: 300 V / 10 A	
Qty.	36 pc(s).	(l): 1.5 mm, tinned, black, Box		
Type	SL-SMT 3.50/12/180LF 3. ...	Version	Product data	Packaging
Order No.	<a href="#">1842640000</a>	PCB plug-in connector, male header, Solder flange, THT/THR solder	IEC: 320 V / 15 A	Box
GTIN (EAN)	4032248354009	connection, 3.50 mm, Number of poles: 12, 180°, Solder pin length	UL: 300 V / 10 A	
Qty.	36 pc(s).	(l): 3.2 mm, tinned, black, Box		

## OMNIMATE Signal - series BL/SL 3.50 BL 3.50/12/90F SN BK BX

**Weidmüller Interface GmbH & Co. KG**  
 Klingenbergstraße 26  
 D-32758 Detmold  
 Germany  
 Fon: +49 5231 14-0  
 Fax: +49 5231 14-292083  
 www.weidmueller.com

# Accessories

## Coding elements



**Only connects what is supposed to be connected:  
the right connection at the right place.**

Coding elements and locking devices clearly assign connecting elements during the manufacturing process and operation

The coding elements and locking devices are inserted prior to assembly or during the cable assembly phase. The Weidmüller alternative: configure online using the variant configurator to precode prior to delivery.

Incorrect assembly on the circuit board and incorrect plugging of connecting elements is no longer possible. The advantage: no troubleshooting during manufacture and no operational errors by the user.

## General ordering data

Type	BL SL 3.5 KO SW	Version	Product data	Packaging
Order No.	<a href="#">1610100000</a>	PCB plug-in connector, Accessories, Coding element, black, Number		Box
GTIN (EAN)	4008190187637	of poles: 1		
Qty.	100 pc(s).			
Type	BL SL 3.5 KO OR	Version	Product data	Packaging
Order No.	<a href="#">1693430000</a>	PCB plug-in connector, Accessories, Coding element, orange, Number		Box
GTIN (EAN)	4008190867447	of poles: 1		
Qty.	100 pc(s).			

DIE DEUTSCHE VERSION IST VERBINDLICH  
THE GERMAN VERSION IS BINDING

WEITERGABE SOWIE VERVIELFÄLTIGUNG DIESES DOKUMENTS, VERWERTUNG UND MITTEILUNG SEINES INHALTS SIND VERBOTEN, SOWEIT NICHT AUSDRUECKLICH GESTATTET.  
ZUWIDERHANDLUNGEN VERPFLICHTEN ZU SCHADENERSATZ. ALLE RECHTE FUER DEN FALL DER PATENT-, GEBRAUCHSMUSTER- ODER GESCHMACKSMUSTEREINTRAGUNG VORBEHALTEN.  
THE REPRODUCTION, DISTRIBUTION AND UTILIZATION OF THIS DOCUMENT AS WELL AS THE COMMUNICATION OF ITS CONTENTS TO OTHERS WITHOUT EXPLICIT AUTHORIZATION IS PROHIBITED.  
OFFENDERS WILL BE HELD LIABLE FOR THE PAYMENT OF DAMAGES. WEIDMUELLER EXCLUSIVELY RESERVES THE RIGHT TO FILE FOR PATENTS, UTILITY MODELS OR DESIGNS.  
© WEIDMUELLER INTERFACE GmbH & Co.KG

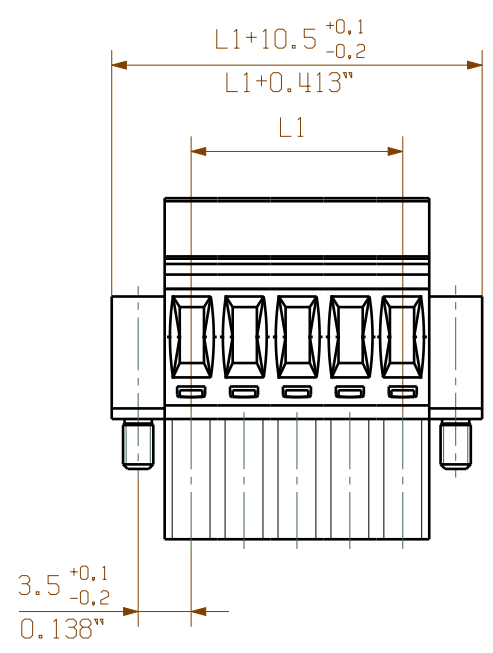

SCREWDRIVER

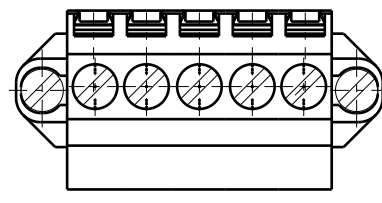
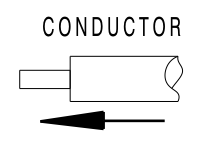
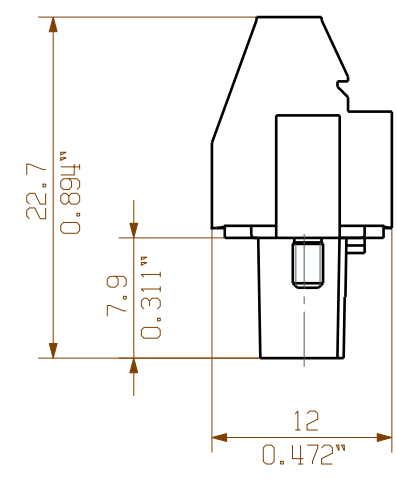

24	80,50	3,169
23	77,00	3,031
22	73,50	2,894
21	70,00	2,756
20	66,50	2,618
19	63,00	2,480
18	59,50	2,343
17	56,00	2,205
16	52,50	2,067
15	49,00	1,929
14	45,50	1,791
13	42,00	1,654
12	38,50	1,516
11	35,00	1,378
10	31,50	1,240
9	28,00	1,102
8	24,50	0,965
7	21,00	0,827
6	17,50	0,689
5	14,00	0,551
4	10,50	0,413
3	7,00	0,276
2	3,50	0,138
n	L1[mm]	L1 [Inch]

BL 3.50/05/90F

For the mounting of PCBs, it should be noted that the rated data given in the catalogue relates only to the connection elements. The necessary creepage and clearance paths must be observed in connection with the respective applicant in accordance with VDE 0110. The current-carrying capacity and pitch tolerance is to be determined according to DIN IEC 326 part 3 very fine.

Weidmüller connectors are tested to the DIN VDE 0627 standard, and are valid for its field of application. Provided that the components are used to the intended purpose, all requirements with respect to the occurring of electrical, mechanical, thermic and corrosive stress will be satisfied.

	METRIC TOLERANCES: X. = ±0.3 X.X = ±0.1 X.XX = ±0.05		CAT.NO.:		
	60340/0 15.09.11 HELIS_MA 01		C 21346 15		
MODIFICATION		DRAWING NO. SHEET 02 OF 03 SHEETS		ISSUE NO.	
		DATE 24.07.2003	NAME KOWOLLIK_R	BL 3.50/././90... BUCHSENSTECKER FEMALE PLUG	
SCALE: 5/1		RESPONSIBLE LANG_T	CHECKED 15.09.2011 RIEPENHAUSEN_H		
SUPERSEDES: .		APPROVED HECKERT_M	PRODUCT FILE: BL 3.50		