

OMNIMATE Signal - series BL/SL 3.50 BL 3.50/22/90 SN OR BX

Weidmüller Interface GmbH & Co. KG
Klingenbergstraße 26
D-32758 Detmold
Germany
Fon: +49 5231 14-0
Fax: +49 5231 14-292083
www.weidmueller.com

Product image

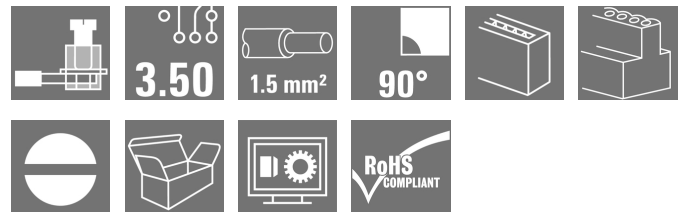

Similar to illustration

Female connectors with clamping yoke screw system for connecting conductors at 3.50 mm pitch. They provide space for labelling and can be coded.

General ordering data

Type	BL 3.50/22/90 SN OR BX
Order No.	1638750000
Version	PCB plug-in connector, female plug, 3.50 mm, Number of poles: 22, 90°, Clamping yoke connection, Clamping range, max. : 1.5 mm², Box
GTIN (EAN)	4008190276294
Qty.	24 pc(s).
Product data	IEC: 320 V / 12 A / 0.2 - 1.5 mm² UL: 300 V / 8 A / AWG 28 - AWG 14
Packaging	Box

Creation date May 3, 2020 5:54:41 PM CEST

**OMNIMATE Signal - series BL/SL 3.50
BL 3.50/22/90 SN OR BX**

Weidmüller Interface GmbH & Co. KG
 Klingenbergstraße 26
 D-32758 Detmold
 Germany
 Fon: +49 5231 14-0
 Fax: +49 5231 14-292083
 www.weidmueller.com

Technical data**Dimensions and weights**

Width	77 mm	Width (inches)	3.031 inch
Height	12 mm	Height (inches)	0.472 inch
Depth	22.45 mm	Depth (inches)	0.884 inch
Net weight	20.65 g		

System Parameters

Product family	OMNIMATE Signal - series BL/SL 3.50	Type of connection	Field connection
Wire connection method	Clamping yoke connection	Pitch in mm (P)	3.5 mm
Pitch in inches (P)	0.138 inch	Conductor outlet direction	90°
Number of poles	22	L1 in mm	73.5 mm
L1 in inches	2.894 inch	Number of rows	1
Pin series quantity	1	Rated cross-section	1.5 mm ²
Touch-safe protection acc. to DIN VDE 57 106	Safe from finger touch	Touch-safe protection acc. to DIN VDE 0470	IP 20
Volume resistance	≤ 5mΩ	Can be coded	Yes
Stripping length	6 mm	Tightening torque, min.	0.2 Nm
Tightening torque, max.	0.25 Nm	Clamping screw	M 2
Screwdriver blade	0.4 x 2.5	Screwdriver blade standard	DIN 5264
Plugging cycles	25	Plugging force/pole, max.	7 N
Pulling force/pole, max.	5 N		

Material data

Insulating material	PBT	Colour	orange
Colour chart (similar)	RAL 2000	Insulating material group	IIIa
Comparative Tracking Index (CTI)	≥ 200	Insulation strength	≥ 10 ⁸ Ω
UL 94 flammability rating	V-0	GWFI	960 °C
Contact material	Copper alloy	Contact surface	tinned
Layer structure of plug contact	4-8 μm Sn hot-dip tinned	Storage temperature, min.	-25 °C
Storage temperature, max.	50 °C	Max. relative humidity during storage	70 %
Operating temperature, min.	-50 °C	Operating temperature, max.	100 °C
Temperature range, installation, min.	-30 °C	Temperature range, installation, max.	100 °C

Conductors suitable for connection

Clamping range, min.	0.08 mm ²
Clamping range, max.	1.5 mm ²
Wire connection cross section AWG, min.	AWG 28
Wire connection cross section AWG, max.	AWG 14
Solid, min. H05(07) V-U	0.2 mm ²
Solid, max. H05(07) V-U	1.5 mm ²
Flexible, min. H05(07) V-K	0.2 mm ²
Flexible, max. H05(07) V-K	1.5 mm ²
w. plastic collar ferrule, DIN 46228 pt 4, 0.2 mm ² min.	
w. plastic collar ferrule, DIN 46228 pt 4, 1.5 mm ² max.	
w. wire end ferrule, DIN 46228 pt 1, 0.2 mm ² min.	
w. wire end ferrule, DIN 46228 pt 1, 1.5 mm ² max.	

Creation date May 3, 2020 5:54:41 PM CEST

OMNIMATE Signal - series BL/SL 3.50
BL 3.50/22/90 SN OR BX

Weidmüller Interface GmbH & Co. KG
 Klingenbergstraße 26
 D-32758 Detmold
 Germany
 Fon: +49 5231 14-0
 Fax: +49 5231 14-292083
 www.weidmueller.com

Technical data

Plug gauge in accordance with EN 60999 a x b; ø 2.4 mm x 1.5 mm

Clampable conductor	Cross-section for conductor connection	Type	fine-wired
		nominal	0.5 mm ²
wire end ferrule	Stripping length	nominal	8 mm
		Recommended wire-end ferrule	H0.5/12 OR
		nominal	6 mm
		Recommended wire-end ferrule	H0.5/6
Cross-section for conductor connection	Type	fine-wired	
	nominal	0.75 mm ²	
wire end ferrule	Stripping length	nominal	8 mm
		Recommended wire-end ferrule	H0.75/12 W
		nominal	6 mm
		Recommended wire-end ferrule	H0.75/6
Cross-section for conductor connection	Type	fine-wired	
	nominal	1 mm ²	
wire end ferrule	Stripping length	nominal	8 mm
		Recommended wire-end ferrule	H1.0/12 GE
		nominal	6 mm
		Recommended wire-end ferrule	H1.0/6
Cross-section for conductor connection	Type	fine-wired	
	nominal	0.25 mm ²	
wire end ferrule	Stripping length	nominal	8 mm
		Recommended wire-end ferrule	H0.25/10 HBL
		nominal	5 mm
		Recommended wire-end ferrule	H0.25/5
Cross-section for conductor connection	Type	fine-wired	
	nominal	0.34 mm ²	
wire end ferrule	Stripping length	nominal	8 mm
	Recommended wire-end ferrule	H0.34/10 TK	

Reference text The outside diameter of the plastic collar should not be larger than the pitch (P). Length of ferrules is to be chosen depending on the product and the rated voltage.

Max. clamping range 1.5 mm²

Rated data acc. to IEC

tested acc. to standard	IEC 60664-1, IEC 61984	Rated current, min. number of poles (Tu=20°C)	12 A
Rated current, max. number of poles (Tu=20°C)	10 A	Rated current, min. number of poles (Tu=40°C)	10 A
Rated current, max. number of poles (Tu=40°C)	8 A	Rated voltage for surge voltage class / pollution degree II/2	320 V
Rated voltage for surge voltage class / pollution degree III/2	160 V	Rated voltage for surge voltage class / pollution degree III/3	160 V
Rated impulse voltage for surge voltage class/ pollution degree II/2	2.5 kV	Rated impulse voltage for surge voltage class/ pollution degree III/2	2.5 kV
Rated impulse voltage for surge voltage class/ contamination degree III/3	2.5 kV	Short-time withstand current resistance	3 x 1s with 100 A

**OMNIMATE Signal - series BL/SL 3.50
BL 3.50/22/90 SN OR BX**

Weidmüller Interface GmbH & Co. KG
 Klingenbergstraße 26
 D-32758 Detmold
 Germany
 Fon: +49 5231 14-0
 Fax: +49 5231 14-292083
 www.weidmueller.com

Technical data**Rated data acc. to CSA**

Institute (CSA)



Certificate No. (CSA)

154685-1318353

Rated voltage (Use group B / CSA)	300 V
Rated current (Use group B / CSA)	10 A
Wire cross-section, AWG, min.	AWG 28
Reference to approval values	Specifications are maximum values, details - see approval certificate.

Rated voltage (Use group D / CSA)	300 V
Rated current (Use group D / CSA)	10 A
Wire cross-section, AWG, max.	AWG 14

Rated data acc. to UL 1059

Institute (UR)



Certificate No. (UR)

E60693

Rated voltage (Use group B / UL 1059)	300 V
Rated current (Use group B / UL 1059)	8 A
Wire cross-section, AWG, min.	AWG 28
Reference to approval values	Specifications are maximum values, details - see approval certificate.

Rated voltage (Use group D / UL 1059)	300 V
Rated current (Use group D / UL 1059)	8 A
Wire cross-section, AWG, max.	AWG 14

Packing

Packaging	Box	VPE length	70 mm
VPE width	84 mm	VPE height	104 mm

Classifications

ETIM 6.0	EC002638	ETIM 7.0	EC002638
eClass 9.0	27-44-03-09	eClass 9.1	27-44-03-09
eClass 10.0	27-44-03-09	UNSPSC	30-21-18-10

Data sheet

**OMNIMATE Signal - series BL/SL 3.50
BL 3.50/22/90 SN OR BX**

Weidmüller Interface GmbH & Co. KG
Klingenbergstraße 26
D-32758 Detmold
Germany
Fon: +49 5231 14-0
Fax: +49 5231 14-292083
www.weidmueller.com

Technical data

Notes

Notes	<ul style="list-style-type: none"> • Additional colours on request • Gold-plated contact surfaces on request • Rated current related to rated cross-section & min. No. of poles. • Max. outer diameter of the conductor: 2.9 mm • Wire end ferrule without plastic collar to DIN 46228/1 • Wire end ferrule with plastic collar to DIN 46228/4 • P on drawing = pitch • Rated data refer only to the component itself. Clearance and creepage distances to other components are to be designed in accordance with the relevant application standards.
IPC conformity	Conformity: The products are developed, manufactured and delivered according international recognized standards and norms and comply with the assured properties in the data sheet resp. fulfill decorative properties in accordance with IPC-A-610 "Class 2". Further claims on the products can be evaluated on request.

Approvals

Approvals	
ROHS	Conform

Downloads

Approval/Certificate/Document of Conformity	Declaration of the Manufacturer
Brochure/Catalogue	FL DRIVES EN MB DEVICE MANUF. EN FL DRIVES DE CAT 2 PORTFOLIOGUIDE EN FL BUILDING SAFETY EN FL APPL LED LIGHTING EN FLIndustr.CONTROLS EN FL MACHINE SAFETY EN FL HEATING ELECTR EN FL APPL INVERTER EN FL_BASE_STATION_EN FL ELEVATOR EN FL POWER SUPPLY EN FL 72H SAMPLE SER EN PO OMNIMATE EN
Engineering Data	EPLAN.WSCAD
Engineering Data	STEP

**OMNIMATE Signal - series BL/SL 3.50
BL 3.50/22/90 SN OR BX**

Weidmüller Interface GmbH & Co. KG
Klingenbergstraße 26
D-32758 Detmold
Germany
Fon: +49 5231 14-0
Fax: +49 5231 14-292083
www.weidmueller.com

Drawings

Dimensional drawing

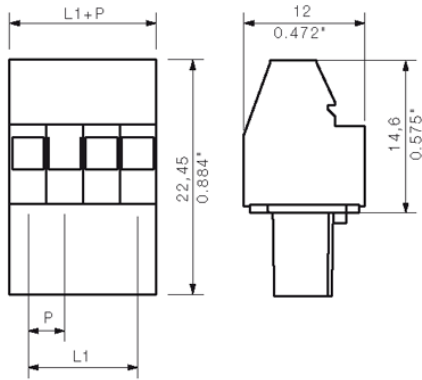

Graph

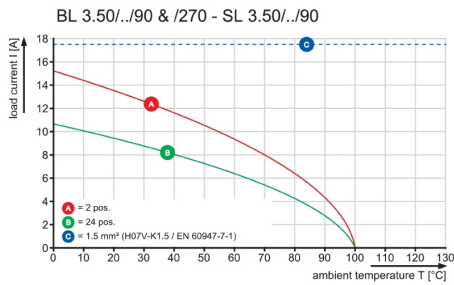

Graph

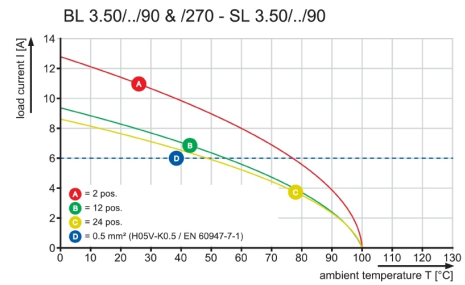

**OMNIMATE Signal - series BL/SL 3.50
BL 3.50/22/90 SN OR BX**

Weidmüller Interface GmbH & Co. KG
Klingenbergstraße 26
D-32758 Detmold
Germany
Fon: +49 5231 14-0
Fax: +49 5231 14-292083
www.weidmueller.com

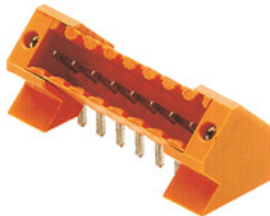
Mating connector (conditionally pluggable)
SL 3.50/135F

Pin headers for wave soldering in 3.50 mm pitch

- Plugging direction is parallel (90°), straight 180° or angled (135°) to the PCB
- Housing variant: screw flange (F)
- Packed in a cardboard box (BX)
- Pin header can be coded

General ordering data

Type	SL 3.50/22/135F 3.2SN O ...	Version	Product data	Packaging
Order No.	1643530000	PCB plug-in connector, male header, Flange, THT solder connection,	IEC: 320 V / 15 A	Box
GTIN (EAN)	4008190282295	3.50 mm, Number of poles: 22, 135°, Solder pin length (l): 3.2 mm,	UL: 300 V / 10 A	
Qty.	18 pc(s).	tinned, orange, Box		

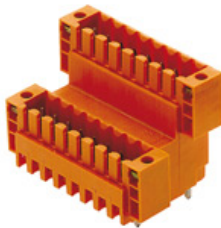
SLD 3.50V/180F

Double-level, staggered pin header for wave soldering at 3.50 mm pitch. They are available in closed and flanged versions. The male connectors provide space for labelling and can be coded.

General ordering data

Type	SLD 3.50 V/44/180F 3.2 ...	Version	Product data	Packaging
Order No.	1641340000	PCB plug-in connector, male header, Flange, THT solder connection,	IEC: 200 V / 10.5 A	Box
GTIN (EAN)	4008190279745	3.50 mm, Number of poles: 44, 180°, Solder pin length (l): 3.2 mm,	UL: 300 V / 8 A	
Qty.	10 pc(s).	tinned, orange, Box		

**OMNIMATE Signal - series BL/SL 3.50
BL 3.50/22/90 SN OR BX**

Weidmüller Interface GmbH & Co. KG
 Klingenbergstraße 26
 D-32758 Detmold
 Germany
 Fon: +49 5231 14-0
 Fax: +49 5231 14-292083
 www.weidmueller.com

Mating connector (conditionally pluggable)
SL-SMT 3.5/90LF Box

High-temperature-resistant male header, 3.50 mm pitch.

- **Plugging direction parallel (90°), straight 180° or angled (135°) to PCB**
- **Housing variants: closed side (G), screw flange (F), solder flange (LF) or snap-on solder flange (RF)**
- **Optimised for the SMT process**
- **Pin length 3.2 mm universal for all soldering methods**
- **Pin length 1.5 mm optimised for reflow soldering methods**
- **Packed either in a box (BX) or tape-on-reel (RL)**
- **Male header can be coded**

General ordering data

Type	SL-SMT 3.50/22/90LF 3.2 ...	Version	Product data	Packaging
Order No.	1842050000	PCB plug-in connector, male header, Solder flange, THT/THR solder	IEC: 320 V / 15 A	Box
GTIN (EAN)	4032248353408	connection, 3.50 mm, Number of poles: 22, 90°, Solder pin length (l):	UL: 300 V / 10 A	
Qty.	18 pc(s).	3.2 mm, tinned, black, Box		
Type	SL-SMT 3.50/22/90LF 1.5 ...	Version	Product data	Packaging
Order No.	1805140000	PCB plug-in connector, male header, Solder flange, THT/THR solder	IEC: 320 V / 15 A	Box
GTIN (EAN)	4032248269044	connection, 3.50 mm, Number of poles: 22, 90°, Solder pin length (l):	UL: 300 V / 10 A	
Qty.	20 pc(s).	1.5 mm, tinned, black, Box		

**OMNIMATE Signal - series BL/SL 3.50
BL 3.50/22/90 SN OR BX**

Weidmüller Interface GmbH & Co. KG
Klingenbergstraße 26
D-32758 Detmold
Germany
Fon: +49 5231 14-0
Fax: +49 5231 14-292083
www.weidmueller.com

Mating connector (conditionally pluggable)
SL-SMT 3.5/180F Box

High-temperature-resistant male header, 3.50 mm pitch.

- **Plugging direction parallel (90°), straight 180° or angled (135°) to PCB**
- **Housing variants: closed side (G), screw flange (F), solder flange (LF) or snap-on solder flange (RF)**
- **Optimised for the SMT process**
- **Pin length 3.2 mm universal for all soldering methods**
- **Pin length 1.5 mm optimised for reflow soldering methods**
- **Packed either in a box (BX) or tape-on-reel (RL)**
- **Male header can be coded**

General ordering data

Type	SL-SMT 3.50/22/180F 3.2 ...	Version	Product data	Packaging
Order No.	1842970000	PCB plug-in connector, male header, Flange, THT/THR solder connection, 3.50 mm, Number of poles: 22, 180°, Solder pin length (l): 3.2 mm, tinned, black, Box	IEC: 320 V / 15 A UL: 300 V / 10 A	Box
GTIN (EAN)	4032248354436			
Qty.	18 pc(s).			

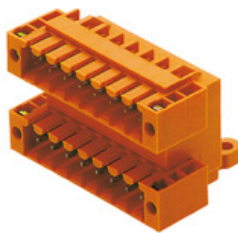
SLD 3.50/90F

Two-tier pin header for wave soldering in 3.50 mm pitch. The connector is available in open, closed and flange versions. The male connectors provide space for labelling and can be coded. Packed in a cardboard box.

General ordering data

Type	SLD 3.50/44/90F 3.2SN O ...	Version	Product data	Packaging
Order No.	1634010000	PCB plug-in connector, male header, Flange, THT solder connection, 3.50 mm, Number of poles: 44, 90°, Solder pin length (l): 3.2 mm, tinned, orange, Box	IEC: 200 V / 10.5 A UL: 300 V / 8 A	Box
GTIN (EAN)	4008190258467			
Qty.	10 pc(s).			

**OMNIMATE Signal - series BL/SL 3.50
BL 3.50/22/90 SN OR BX**

Weidmüller Interface GmbH & Co. KG
Klingenbergstraße 26
D-32758 Detmold
Germany
Fon: +49 5231 14-0
Fax: +49 5231 14-292083
www.weidmueller.com

Mating connector (conditionally pluggable)
SLD 3.50V/90F

Double-level, staggered pin header for wave soldering at 3.50 mm pitch. They are available in closed and flanged versions. The male connectors provide space for labelling and can be coded.

General ordering data

Type	SLD 3.50 V/44/90F 3.2 S ...	Version	Product data	Packaging
Order No.	1642470000	PCB plug-in connector, male header, Flange, THT solder connection,	IEC: 200 V / 10.5 A	Box
GTIN (EAN)	4008190280994	3.50 mm, Number of poles: 44, 90°, Solder pin length (l): 3.2 mm,	UL: 300 V / 8 A	
Qty.	10 pc(s).	tinned, orange, Box		

SL-SMT 3.5/180G Box

High-temperature-resistant male header, 3.50 mm pitch.

- **Plugging direction parallel (90°), straight 180° or angled (135°) to PCB**
- **Housing variants: closed side (G), screw flange (F), solder flange (LF) or snap-on solder flange (RF)**
- **Optimised for the SMT process**
- **Pin length 3.2 mm universal for all soldering methods**
- **Pin length 1.5 mm optimised for reflow soldering methods**
- **Packed either in a box (BX) or tape-on-reel (RL)**
- **Male header can be coded**

General ordering data

Type	SL-SMT 3.50/22/180G 1.5 ...	Version	Product data	Packaging
Order No.	1753182001	PCB plug-in connector, male header, closed side, THT/THR solder	IEC: 320 V / 15 A	Box
GTIN (EAN)	4032248131082	connection, 3.50 mm, Number of poles: 22, 180°, Solder pin length	UL: 300 V / 10 A	
Qty.	20 pc(s).	(l): 1.5 mm, tinned, black, Box		
Type	SL-SMT 3.50/22/180G 3.2 ...	Version	Product data	Packaging
Order No.	1842510000	PCB plug-in connector, male header, closed side, THT/THR solder	IEC: 320 V / 15 A	Box
GTIN (EAN)	4032248353873	connection, 3.50 mm, Number of poles: 22, 180°, Solder pin length	UL: 300 V / 10 A	
Qty.	20 pc(s).	(l): 3.2 mm, tinned, black, Box		

**OMNIMATE Signal - series BL/SL 3.50
BL 3.50/22/90 SN OR BX**

Weidmüller Interface GmbH & Co. KG
Klingenbergstraße 26
D-32758 Detmold
Germany
Fon: +49 5231 14-0
Fax: +49 5231 14-292083
www.weidmueller.com

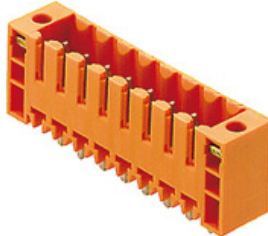
Mating connector (conditionally pluggable)
SL 3.50/180F

Pin headers for wave soldering in 3.50 mm pitch

- Plugging direction is parallel (90°), straight 180° or angled (135°) to the PCB
- Housing variant: screw flange (F)
- Packed in a cardboard box (BX)
- Pin header can be coded

General ordering data

Type	SL 3.50/22/180F 3.2SN G ...	Version	Product data	Packaging
Order No.	1622460000	PCB plug-in connector, male header, Flange, THT solder connection,	IEC: 320 V / 17 A	Box
GTIN (EAN)	4008190193126	3.50 mm, Number of poles: 22, 180°, Solder pin length (l): 3.2 mm,	UL: 300 V / 10 A	
Qty.	20 pc(s).	tinned, Pebble grey, Box		
Type	SL 3.50/22/180F 4.5SN O ...	Version	Product data	Packaging
Order No.	1618880000	PCB plug-in connector, male header, Flange, THT solder connection,	IEC: 320 V / 17 A	Box
GTIN (EAN)	4008190129484	3.50 mm, Number of poles: 22, 180°, Solder pin length (l): 4.5 mm,	UL: 300 V / 10 A	
Qty.	20 pc(s).	tinned, orange, Box		
Type	SL 3.50/22/180F 3.2SN D ...	Version	Product data	Packaging
Order No.	1622680000	PCB plug-in connector, male header, Flange, THT solder connection,	IEC: 320 V / 17 A	Box
GTIN (EAN)	4008190193348	3.50 mm, Number of poles: 22, 180°, Solder pin length (l): 3.2 mm,	UL: 300 V / 10 A	
Qty.	20 pc(s).	tinned, Signal green, Box		
Type	SL 3.50/22/180F 3.2SN O ...	Version	Product data	Packaging
Order No.	1622230000	PCB plug-in connector, male header, Flange, THT solder connection,	IEC: 320 V / 17 A	Box
GTIN (EAN)	4008190189396	3.50 mm, Number of poles: 22, 180°, Solder pin length (l): 3.2 mm,	UL: 300 V / 10 A	
Qty.	20 pc(s).	tinned, orange, Box		
Type	SL 3.50/22/180F 4.5SN B ...	Version	Product data	Packaging
Order No.	1618960000	PCB plug-in connector, male header, Flange, THT solder connection,	IEC: 320 V / 17 A	Box
GTIN (EAN)	4008190131050	3.50 mm, Number of poles: 22, 180°, Solder pin length (l): 4.5 mm,	UL: 300 V / 10 A	
Qty.	20 pc(s).	tinned, black, Box		

OMNIMATE Signal - series BL/SL 3.50 BL 3.50/22/90 SN OR BX

Weidmüller Interface GmbH & Co. KG
Klingenbergstraße 26
D-32758 Detmold
Germany
Fon: +49 5231 14-0
Fax: +49 5231 14-292083
www.weidmueller.com

Mating connector (conditionally pluggable)

SL-SMT 3.5/90F Box



High-temperature-resistant male header, 3.50 mm pitch.

- **Plugging direction parallel (90°), straight 180° or angled (135°) to PCB**
- **Housing variants: closed side (G), screw flange (F), solder flange (LF) or snap-on solder flange (RF)**
- **Optimised for the SMT process**
- **Pin length 3.2 mm universal for all soldering methods**
- **Pin length 1.5 mm optimised for reflow soldering methods**
- **Packed either in a box (BX) or tape-on-reel (RL)**
- **Male header can be coded**

General ordering data

Type	SL-SMT 3.50/22/90F 3.2S ...	Version	Product data	Packaging
Order No.	1842280000	PCB plug-in connector, male header, Flange, THT/THR solder connection, 3.50 mm, Number of poles: 22, 90°, Solder pin length (l): 3.2 mm, tinned, black, Box	IEC: 320 V / 15 A UL: 300 V / 10 A	Box
GTIN (EAN)	4032248353637			
Qty.	18 pc(s).			

SL 3.50/90F

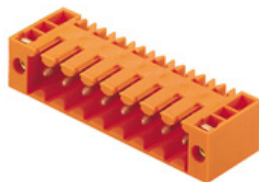

Pin headers for wave soldering in 3.50 mm pitch

- **Plugging direction is parallel (90°), straight 180° or angled (135°) to the PCB**
- **Housing variant: screw flange (F)**
- **Packed in a cardboard box (BX)**
- **Pin header can be coded**

General ordering data

Type	SL 3.50/22/90F 4.5 SN ...	Version	Product data	Packaging
Order No.	1618330000	PCB plug-in connector, male header, Flange, THT solder connection, 3.50 mm, Number of poles: 22, 90°, Solder pin length (l): 4.5 mm, tinned, black, Box	IEC: / 17 A UL: 300 V / 10 A	Box
GTIN (EAN)	4008190120573			
Qty.	20 pc(s).			
Type	SL 3.50/22/90F 3.2SN GY ...	Version	Product data	Packaging
Order No.	1620050000	PCB plug-in connector, male header, Flange, THT solder connection, 3.50 mm, Number of poles: 22, 90°, Solder pin length (l): 3.2 mm, tinned, Pebble grey, Box	IEC: / 17 A UL: 300 V / 10 A	Box
GTIN (EAN)	4008190150921			
Qty.	20 pc(s).			
Type	SL 3.50/22/90F 3.2SN OR ...	Version	Product data	Packaging
Order No.	1619820000	PCB plug-in connector, male header, Flange, THT solder connection, 3.50 mm, Number of poles: 22, 90°, Solder pin length (l): 3.2 mm, tinned, orange, Box	IEC: / 17 A UL: 300 V / 10 A	Box
GTIN (EAN)	4008190147587			
Qty.	20 pc(s).			

OMNIMATE Signal - series BL/SL 3.50 BL 3.50/22/90 SN OR BX

Weidmüller Interface GmbH & Co. KG
 Klingenbergstraße 26
 D-32758 Detmold
 Germany
 Fon: +49 5231 14-0
 Fax: +49 5231 14-292083
 www.weidmueller.com

Mating connector (conditionally pluggable)

Type	SL 3.50/22/90F 4.5SN OR ...	Version	Product data	Packaging
Order No.	1618250000	PCB plug-in connector, male header, Flange, THT solder connection,	IEC: / 17 A	Box
GTIN (EAN)	4008190119041	3.50 mm, Number of poles: 22, 90°, Solder pin length (l): 4.5 mm,	UL: 300 V / 10 A	
Qty.	20 pc(s).	tinned, orange, Box		
Type	SL 3.50/22/90F 3.2SN DK ...	Version	Product data	Packaging
Order No.	1620260000	PCB plug-in connector, male header, Flange, THT solder connection,	IEC: / 17 A	Box
GTIN (EAN)	4008190153960	3.50 mm, Number of poles: 22, 90°, Solder pin length (l): 3.2 mm,	UL: 300 V / 10 A	
Qty.	20 pc(s).	tinned, Signal green, Box		

SL-SMT 3.5/180LF Box



High-temperature-resistant male header, 3.50 mm pitch.

- **Plugging direction parallel (90°), straight 180° or angled (135°) to PCB**
- **Housing variants: closed side (G), screw flange (F), solder flange (LF) or snap-on solder flange (RF)**
- **Optimised for the SMT process**
- **Pin length 3.2 mm universal for all soldering methods**
- **Pin length 1.5 mm optimised for reflow soldering methods**
- **Packed either in a box (BX) or tape-on-reel (RL)**
- **Male header can be coded**

General ordering data

Type	SL-SMT 3.50/22/180LF 3. ...	Version	Product data	Packaging
Order No.	1842740000	PCB plug-in connector, male header, Solder flange, THT/THR solder	IEC: 320 V / 15 A	Box
GTIN (EAN)	4032248354108	connection, 3.50 mm, Number of poles: 22, 180°, Solder pin length	UL: 300 V / 10 A	
Qty.	18 pc(s).	(l): 3.2 mm, tinned, black, Box		
Type	SL-SMT 3.50/22/180LF 1. ...	Version	Product data	Packaging
Order No.	1804910000	PCB plug-in connector, male header, Solder flange, THT/THR solder	IEC: 320 V / 15 A	Box
GTIN (EAN)	4032248268672	connection, 3.50 mm, Number of poles: 22, 180°, Solder pin length	UL: 300 V / 10 A	
Qty.	20 pc(s).	(l): 1.5 mm, tinned, black, Box		

**OMNIMATE Signal - series BL/SL 3.50
BL 3.50/22/90 SN OR BX**

Weidmüller Interface GmbH & Co. KG
Klingenbergstraße 26
D-32758 Detmold
Germany
Fon: +49 5231 14-0
Fax: +49 5231 14-292083
www.weidmuller.com

Mating connector (fully pluggable)
SL-SMT 3.5/90G Tray

High-temperature-resistant male header, 3.50 mm pitch.

- **Plugging direction parallel (90°), straight 180° or angled (135°) to PCB**
- **Housing variants: closed side (G), screw flange (F), solder flange (LF) or snap-on solder flange (RF)**
- **Optimised for the SMT process**
- **Pin length 3.2 mm universal for all soldering methods**
- **Pin length 1.5 mm optimised for reflow soldering methods**
- **Packed either in a box (BX) or tape-on-reel (RL)**
- **Male header can be coded**

General ordering data

Type	SL-SMT 3.50/22/90G 1.5S ...	Version	Product data	Packaging
Order No.	1761743001	PCB plug-in connector, male header, closed side, THT/THR solder connection, 3.50 mm, Number of poles: 22, 90°, Solder pin length (I): 1.5 mm, tinned, black, Tray	IEC: 320 V / 15 A	Tray
GTIN (EAN)	4032248134014		UL: 300 V / 10 A	
Qty.	18 pc(s).			

SL-THR 3.5/135F

High-temperature-resistant male header, 3.50 mm pitch.

- **Plugging direction parallel (90°), straight 180° or angled (135°) to PCB**
- **Housing variants: closed side (G), screw flange (F), solder flange (LF) or snap-on solder flange (RF)**
- **Optimised for the SMT process**
- **Pin length 3.2 mm universal for all soldering methods**
- **Pin length 1.5 mm optimised for reflow soldering methods**
- **Packed either in a box (BX) or tape-on-reel (RL)**
- **Male header can be coded**

General ordering data

Type	SL-SMT 3.50/22/135F 3.2 ...	Version	Product data	Packaging
Order No.	1003720000	PCB plug-in connector, male header, Flange, THT/THR solder connection, 3.50 mm, Number of poles: 22, 135°, Solder pin length (I): 3.2 mm, tinned, black, Box	IEC: 320 V / 15 A	Box
GTIN (EAN)	4032248700349		UL: 300 V / 10 A	
Qty.	18 pc(s).			

**OMNIMATE Signal - series BL/SL 3.50
BL 3.50/22/90 SN OR BX**

Weidmüller Interface GmbH & Co. KG
Klingenbergstraße 26
D-32758 Detmold
Germany
Fon: +49 5231 14-0
Fax: +49 5231 14-292083
www.weidmueller.com

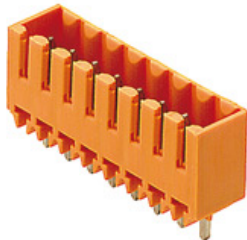
Mating connector (fully pluggable)
SL 3.50/180G

Pin headers for wave soldering in 3.50 mm pitch

- Plugging direction is parallel (90°), straight 180° or angled (135°) to the PCB
- Housing variant: screw flange (F)
- Packed in a cardboard box (BX)
- Pin header can be coded

General ordering data

Type	SL 3.50/22/180G 3.2SN O ...	Version	Product data	Packaging
Order No.	1621840000	PCB plug-in connector, male header, closed side, THT solder	IEC: 320 V / 17 A	Box
GTIN (EAN)	4008190181338	connection, 3.50 mm, Number of poles: 22, 180°, Solder pin length (l): 3.2 mm, tinned, orange, Box	UL: 300 V / 10 A	
Qty.	20 pc(s).			

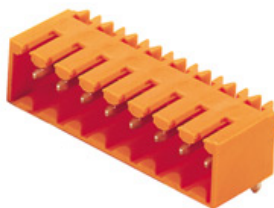
SL 3.50/90G

Pin headers for wave soldering in 3.50 mm pitch

- Plugging direction is parallel (90°), straight 180° or angled (135°) to the PCB
- Housing variant: screw flange (F)
- Packed in a cardboard box (BX)
- Pin header can be coded

General ordering data

Type	SL 3.50/22/90G 4.5SN OR ...	Version	Product data	Packaging
Order No.	1617950000	PCB plug-in connector, male header, closed side, THT solder	IEC: / 17 A	Box
GTIN (EAN)	4008190114633	connection, 3.50 mm, Number of poles: 22, 90°, Solder pin length (l): 4.5 mm, tinned, orange, Box	UL: 300 V / 10 A	
Qty.	20 pc(s).			
Type	SL 3.50/22/90G 3.2SN DK ...	Version	Product data	Packaging
Order No.	1619740000	PCB plug-in connector, male header, closed side, THT solder	IEC: / 17 A	Box
GTIN (EAN)	4008190145903	connection, 3.50 mm, Number of poles: 22, 90°, Solder pin length (l): 3.2 mm, tinned, Signal green, Box	UL: 300 V / 10 A	
Qty.	20 pc(s).			
Type	SL 3.50/22/90G 3.2SN OR ...	Version	Product data	Packaging
Order No.	1619430000	PCB plug-in connector, male header, closed side, THT solder	IEC: / 17 A	Box
GTIN (EAN)	4008190140052	connection, 3.50 mm, Number of poles: 22, 90°, Solder pin length (l): 3.2 mm, tinned, orange, Box	UL: 300 V / 10 A	
Qty.	20 pc(s).			
Type	SL 3.50/22/90G 3.2SN GY ...	Version	Product data	Packaging
Order No.	1619660000	PCB plug-in connector, male header, closed side, THT solder	IEC: / 17 A	Box
GTIN (EAN)	4008190144357	connection, 3.50 mm, Number of poles: 22, 90°, Solder pin length (l): 3.2 mm, tinned, Pebble grey, Box	UL: 300 V / 10 A	
Qty.	20 pc(s).			
Type	SL 3.50/22/90G 4.5SN BK ...	Version	Product data	Packaging
Order No.	1618030000	PCB plug-in connector, male header, closed side, THT solder	IEC: / 17 A	Box
GTIN (EAN)	4008190115869	connection, 3.50 mm, Number of poles: 22, 90°, Solder pin length (l): 4.5 mm, tinned, black, Box	UL: 300 V / 10 A	
Qty.	20 pc(s).			

**OMNIMATE Signal - series BL/SL 3.50
BL 3.50/22/90 SN OR BX**

Weidmüller Interface GmbH & Co. KG
 Klingenbergstraße 26
 D-32758 Detmold
 Germany
 Fon: +49 5231 14-0
 Fax: +49 5231 14-292083
 www.weidmueller.com

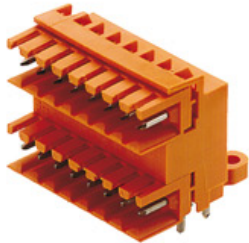
Mating connector (fully pluggable)
SLD 3.50/90

Two-tier pin header for wave soldering in 3.50 mm pitch. The connector is available in open, closed and flange versions. The male connectors provide space for labelling and can be coded. Packed in a cardboard box.

General ordering data

Type	SLD 3.50/44/90 3.2SN OR ...	Version	Product data	Packaging
Order No.	1633550000	PCB plug-in connector, male header, open side, THT solder	IEC: 200 V / 10.5 A	Box
GTIN (EAN)	4008190258009	connection, 3.50 mm, Number of poles: 44, 90°, Solder pin length (l):	UL: 300 V / 8 A	
Qty.	10 pc(s).	3.2 mm, tinned, orange, Box		

SLD 3.50V/90G



Double-level, staggered pin header for wave soldering at 3.50 mm pitch. They are available in closed and flanged versions. The male connectors provide space for labelling and can be coded.

General ordering data

Type	SLD 3.50V/44/90G 3.2SN ...	Version	Product data	Packaging
Order No.	1642340000	PCB plug-in connector, male header, closed side, THT solder	IEC: 200 V / 10.5 A	Box
GTIN (EAN)	4008190280864	connection, 3.50 mm, Number of poles: 44, 90°, Solder pin length (l):	UL: 300 V / 8 A	
Qty.	10 pc(s).	3.2 mm, tinned, orange, Box		

**OMNIMATE Signal - series BL/SL 3.50
BL 3.50/22/90 SN OR BX**

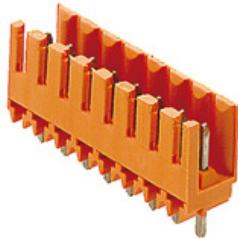
Weidmüller Interface GmbH & Co. KG
Klingenbergstraße 26
D-32758 Detmold
Germany
Fon: +49 5231 14-0
Fax: +49 5231 14-292083
www.weidmueller.com

Mating connector (fully pluggable)
SL 3.50/180

Pin headers for wave soldering in 3.50 mm pitch

- Plugging direction is parallel (90°), straight 180° or angled (135°) to the PCB
- Housing variant: screw flange (F)
- Packed in a cardboard box (BX)
- Pin header can be coded

General ordering data

Type	SL 3.50/22/180 3.2SN OR ...	Version	Product data	Packaging
Order No.	1621450000	PCB plug-in connector, male header, open side, THT solder	IEC: 320 V / 17 A	Box
GTIN (EAN)	4008190173487	connection, 3.50 mm, Number of poles: 22, 180°, Solder pin length	UL: 300 V / 10 A	
Qty.	20 pc(s).	(I): 3.2 mm, tinned, orange, Box		

SL-SMT 3.5/180G Tray

High-temperature-resistant male header, 3.50 mm pitch.

- **Plugging direction parallel (90°), straight 180° or angled (135°) to PCB**
- **Housing variants: closed side (G), screw flange (F), solder flange (LF) or snap-on solder flange (RF)**
- **Optimised for the SMT process**
- **Pin length 3.2 mm universal for all soldering methods**
- **Pin length 1.5 mm optimised for reflow soldering methods**
- **Packed either in a box (BX) or tape-on-reel (RL)**
- **Male header can be coded**

General ordering data

Type	SL-SMT 3.50/22/180G 1.5 ...	Version	Product data	Packaging
Order No.	1753183001	PCB plug-in connector, male header, closed side, THT/THR solder	IEC: 320 V / 15 A	Tray
GTIN (EAN)	4032248133055	connection, 3.50 mm, Number of poles: 22, 180°, Solder pin length	UL: 300 V / 10 A	
Qty.	18 pc(s).	(I): 1.5 mm, tinned, black, Tray		

OMNIMATE Signal - series BL/SL 3.50 BL 3.50/22/90 SN OR BX

Weidmüller Interface GmbH & Co. KG
 Klingenbergstraße 26
 D-32758 Detmold
 Germany
 Fon: +49 5231 14-0
 Fax: +49 5231 14-292083
 www.weidmueller.com

Mating connector (fully pluggable)

SL-SMT 3.5/90G Box



High-temperature-resistant male header, 3.50 mm pitch.

- **Plugging direction parallel (90°), straight 180° or angled (135°) to PCB**
- **Housing variants: closed side (G), screw flange (F), solder flange (LF) or snap-on solder flange (RF)**
- **Optimised for the SMT process**
- **Pin length 3.2 mm universal for all soldering methods**
- **Pin length 1.5 mm optimised for reflow soldering methods**
- **Packed either in a box (BX) or tape-on-reel (RL)**
- **Male header can be coded**

General ordering data

Type	SL-SMT 3.50/22/90G 1.5S ...	Version	Product data	Packaging
Order No.	1761742001	PCB plug-in connector, male header, closed side, THT/THR solder connection, 3.50 mm, Number of poles: 22, 90°, Solder pin length (l): 1.5 mm, tinned, black, Box	IEC: 320 V / 15 A UL: 300 V / 10 A	Box
GTIN (EAN)	4032248132331			
Qty.	20 pc(s).			
Type	SL-SMT 3.50/22/90G 3.2S ...	Version	Product data	Packaging
Order No.	1841830000	PCB plug-in connector, male header, closed side, THT/THR solder connection, 3.50 mm, Number of poles: 22, 90°, Solder pin length (l): 3.2 mm, tinned, black, Box	IEC: 320 V / 15 A UL: 300 V / 10 A	Box
GTIN (EAN)	4032248353187			
Qty.	20 pc(s).			

SL 3.50/90

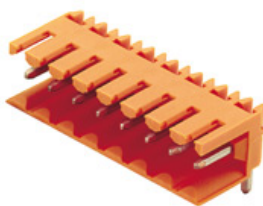

Pin headers for wave soldering in 3.50 mm pitch

- **Plugging direction is parallel (90°), straight 180° or angled (135°) to the PCB**
- **Housing variant: screw flange (F)**
- **Packed in a cardboard box (BX)**
- **Pin header can be coded**

General ordering data

Type	SL 3.50/22/90 4.5SN OR ...	Version	Product data	Packaging
Order No.	1617790000	PCB plug-in connector, male header, open side, THT solder connection, 3.50 mm, Number of poles: 22, 90°, Solder pin length (l): 4.5 mm, tinned, orange, Box	IEC: 320 V / 17 A UL: 300 V / 10 A	Box
GTIN (EAN)	4008190111830			
Qty.	20 pc(s).			
Type	SL 3.50/22/90 3.2SN OR ...	Version	Product data	Packaging
Order No.	1619040000	PCB plug-in connector, male header, open side, THT solder connection, 3.50 mm, Number of poles: 22, 90°, Solder pin length (l): 3.2 mm, tinned, orange, Box	IEC: 320 V / 17 A UL: 300 V / 10 A	Box
GTIN (EAN)	4008190132873			
Qty.	20 pc(s).			

**OMNIMATE Signal - series BL/SL 3.50
BL 3.50/22/90 SN OR BX**

Weidmüller Interface GmbH & Co. KG
Klingenbergstraße 26
D-32758 Detmold
Germany
Fon: +49 5231 14-0
Fax: +49 5231 14-292083
www.weidmueller.com

Mating connector (fully pluggable)

Type	SL 3.50/22/90 3.2SN DKG ...	Version	Product data	Packaging
Order No.	1619350000	PCB plug-in connector, male header, open side, THT solder	IEC: 320 V / 17 A	Box
GTIN (EAN)	4008190138332	connection, 3.50 mm, Number of poles: 22, 90°, Solder pin length (l):	UL: 300 V / 10 A	
Qty.	20 pc(s).	3.2 mm, tinned, Signal green, Box		
Type	SL 3.50/22/90 3.2SN GY ...	Version	Product data	Packaging
Order No.	1619270000	PCB plug-in connector, male header, open side, THT solder	IEC: 320 V / 17 A	Box
GTIN (EAN)	4008190137083	connection, 3.50 mm, Number of poles: 22, 90°, Solder pin length (l):	UL: 300 V / 10 A	
Qty.	20 pc(s).	3.2 mm, tinned, Pebble grey, Box		
Type	SL 3.50/22/90 4.5SN BK ...	Version	Product data	Packaging
Order No.	1617870000	PCB plug-in connector, male header, open side, THT solder	IEC: 320 V / 17 A	Box
GTIN (EAN)	4008190113452	connection, 3.50 mm, Number of poles: 22, 90°, Solder pin length (l):	UL: 300 V / 10 A	
Qty.	20 pc(s).	4.5 mm, tinned, black, Box		

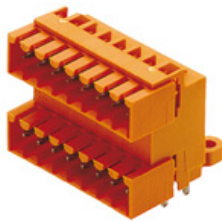
SLD 3.50/90G

Two-tier pin header for wave soldering in 3.50 mm pitch. The connector is available in open, closed and flange versions. The male connectors provide space for labelling and can be coded. Packed in a cardboard box.

General ordering data

Type	SLD 3.50/44/90G 3.2SN O ...	Version	Product data	Packaging
Order No.	1633780000	PCB plug-in connector, male header, closed side, THT solder	IEC: 200 V / 10.5 A	Box
GTIN (EAN)	4008190258238	connection, 3.50 mm, Number of poles: 44, 90°, Solder pin length (l):	UL: 300 V / 8 A	
Qty.	10 pc(s).	3.2 mm, tinned, orange, Box		
Type	SLD 3.50/44/90G 3.2SN D ...	Version	Product data	Packaging
Order No.	1675050000	PCB plug-in connector, male header, closed side, THT solder	IEC: 200 V / 10.5 A	Box
GTIN (EAN)	4008190445744	connection, 3.50 mm, Number of poles: 44, 90°, Solder pin length (l):	UL: 300 V / 8 A	
Qty.	10 pc(s).	3.2 mm, tinned, Signal green, Box		
Type	SLD 3.50/44/90G 4.5SN B ...	Version	Product data	Packaging
Order No.	1634470000	PCB plug-in connector, male header, closed side, THT solder	IEC: 200 V / 10.5 A	Box
GTIN (EAN)	4008190258924	connection, 3.50 mm, Number of poles: 44, 90°, Solder pin length (l):	UL: 300 V / 8 A	
Qty.	10 pc(s).	4.5 mm, tinned, black, Box		

**OMNIMATE Signal - series BL/SL 3.50
BL 3.50/22/90 SN OR BX**

Weidmüller Interface GmbH & Co. KG
 Klingenbergstraße 26
 D-32758 Detmold
 Germany
 Fon: +49 5231 14-0
 Fax: +49 5231 14-292083
 www.weidmueller.com

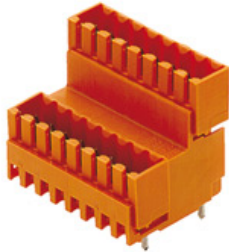
Mating connector (fully pluggable)
SLD 3.50V/180G

Double-level, staggered pin header for wave soldering at 3.50 mm pitch. They are available in closed and flanged versions. The male connectors provide space for labelling and can be coded.

General ordering data

Type	SLD 3.50V/44/180G 3.2SN ...	Version	Product data	Packaging
Order No.	1641210000	PCB plug-in connector, male header, closed side, THT solder	IEC: 200 V / 10.5 A	Box
GTIN (EAN)	4008190279615	connection, 3.50 mm, Number of poles: 44, 180°, Solder pin length	UL: 300 V / 8 A	
Qty.	10 pc(s).	(l): 3.2 mm, tinned, orange, Box		

OMNIMATE Signal - series BL/SL 3.50 BL 3.50/22/90 SN OR BX

Weidmüller Interface GmbH & Co. KG
 Klingenbergstraße 26
 D-32758 Detmold
 Germany
 Fon: +49 5231 14-0
 Fax: +49 5231 14-292083
 www.weidmueller.com

Accessories

Coding elements



**Only connects what is supposed to be connected:
the right connection at the right place.**

Coding elements and locking devices clearly assign connecting elements during the manufacturing process and operation

The coding elements and locking devices are inserted prior to assembly or during the cable assembly phase. The Weidmüller alternative: configure online using the variant configurator to precode prior to delivery.

Incorrect assembly on the circuit board and incorrect plugging of connecting elements is no longer possible. The advantage: no troubleshooting during manufacture and no operational errors by the user.

General ordering data

Type	BL SL 3.5 KO SW	Version	Product data	Packaging
Order No.	1610100000	PCB plug-in connector, Accessories, Coding element, black, Number		Box
GTIN (EAN)	4008190187637	of poles: 1		
Qty.	100 pc(s).			
Type	BL SL 3.5 KO OR	Version	Product data	Packaging
Order No.	1693430000	PCB plug-in connector, Accessories, Coding element, orange, Number		Box
GTIN (EAN)	4008190867447	of poles: 1		
Qty.	100 pc(s).			

DIE DEUTSCHE VERSION IST VERBINDLICH
THE GERMAN VERSION IS BINDING

WEITERGABE SOWIE VERVIELFÄLTIGUNG DIESES DOKUMENTS, VERWERTUNG UND MITTEILUNG SEINES INHALTS SIND VERBOTEN, SOWEIT NICHT AUSDRUECKLICH GESTATTET.
ZUWIDERHANDLUNGEN VERPFLICHTEN ZU SCHADENERSATZ. ALLE RECHTE FUER DEN FALL DER PATENT-, GEBRAUCHSMUSTER- ODER GESCHMACKSMUSTEREINTRAGUNG VORBEHALTEN.
THE REPRODUCTION, DISTRIBUTION AND UTILIZATION OF THIS DOCUMENT AS WELL AS THE COMMUNICATION OF ITS CONTENTS TO OTHERS WITHOUT EXPLICIT AUTHORIZATION IS PROHIBITED.
OFFENDERS WILL BE HELD LIABLE FOR THE PAYMENT OF DAMAGES. WEIDMUELLER EXCLUSIVELY RESERVES THE RIGHT TO FILE FOR PATENTS, UTILITY MODELS OR DESIGNS.
© WEIDMUELLER INTERFACE GmbH & Co.KG

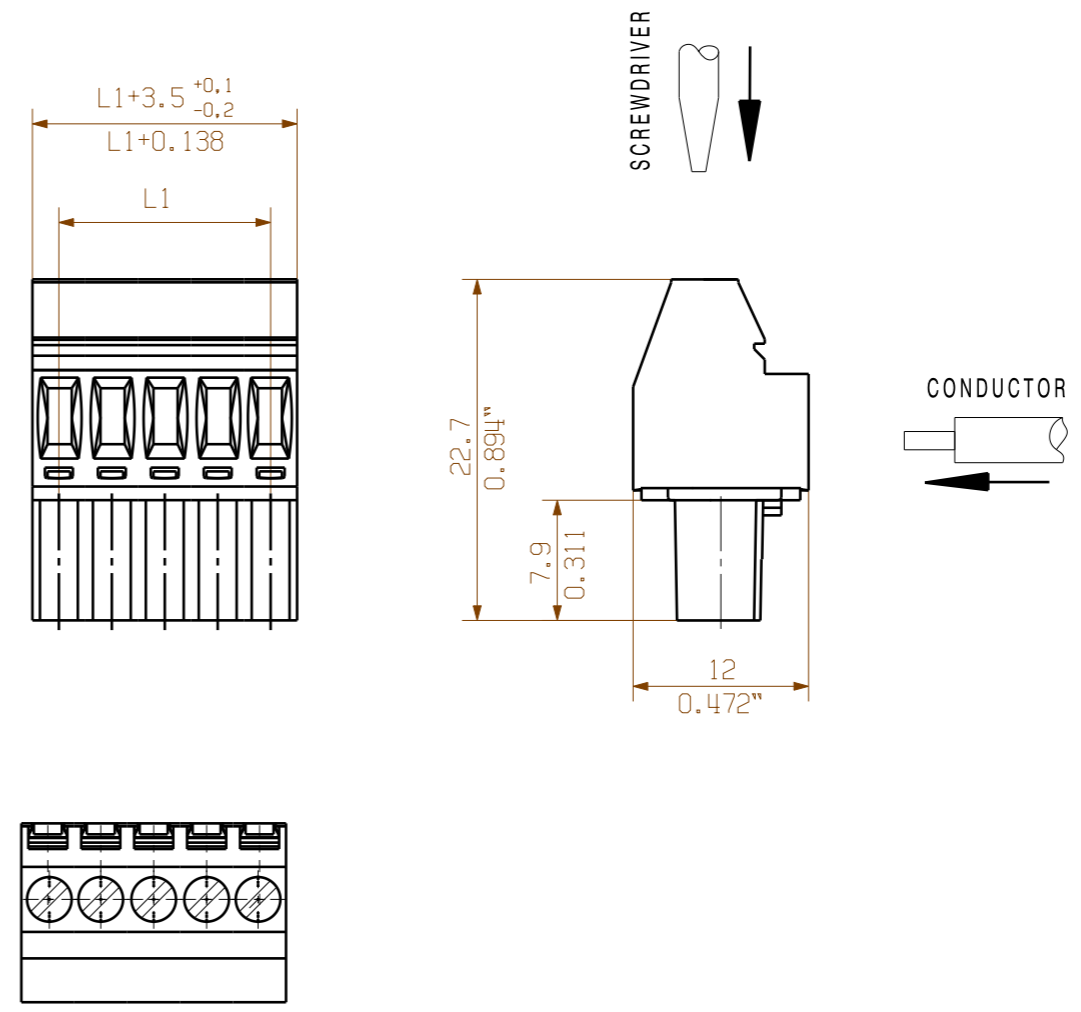

24	80,50	3,169
23	77,00	3,031
22	73,50	2,894
21	70,00	2,756
20	66,50	2,618
19	63,00	2,480
18	59,50	2,343
17	56,00	2,205
16	52,50	2,067
15	49,00	1,929
14	45,50	1,791
13	42,00	1,654
12	38,50	1,516
11	35,00	1,378
10	31,50	1,240
9	28,00	1,102
8	24,50	0,965
7	21,00	0,827
6	17,50	0,689
5	14,00	0,551
4	10,50	0,413
3	7,00	0,276
2	3,50	0,138
n	L1[mm]	L1 [Inch]

SHOWN : BL 3.50/05/90

For the mounting of PCBs, it should be noted that the rated data given in the catalogue relates only to the connection elements. The necessary creepage and clearance paths must be observed in connection with the respective applicant in accordance to VDE 0110. The current-carrying capacity and pitch tolerance is to be determined according to DIN IEC 326 part 3 very fine.

Weidmüller connectors are tested to the DIN VDE 0627 standard, and are valid for its field of application. Provided that the components are used to the intended purpose, all requirements with respect to the occurring of electrical, mechanical, thermic and corrosive stress will be satisfied.

	METRIC TOLERANCES: X. = ±0.3 X.X = ±0.1 X.XX = ±0.05		CAT.NO.:	
	60340/0 15.09.11 HELIS_MA 01		C 21346 15	
MODIFICATION		DRAWING NO. SHEET 01 OF 03 SHEETS		ISSUE NO.
		DATE DRAWN 24.07.2003	NAME KOWOLLIK_R	BL 3.50/././90... BUCHSENSTECKER FEMALE PLUG
SCALE: 5/1		RESPONSIBLE CHECKED 15.09.2011	LANG_T RIEPENHAUSEN_H	
SUPERSEDES: .		APPROVED HECKERT_M	PRODUCT FILE: BL 3.50 7369	