

OMNIMATE Signal - series BL/SL 5.08 SLS 5.08/09/180B SN OR BX

Weidmüller Interface GmbH & Co. KG
Klingenbergstraße 26
D-32758 Detmold
Germany
Fon: +49 5231 14-0
Fax: +49 5231 14-292083
www.weidmueller.com

Product image

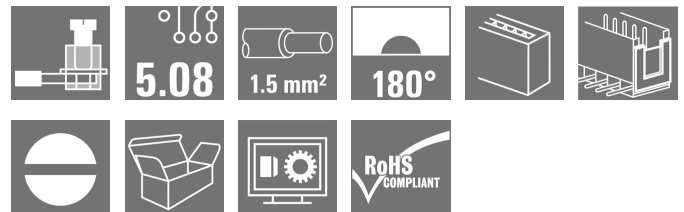

Similar to illustration

Male plugs with clamping-yoke screw wire-connect system. The male plugs provide space for labelling and can be coded.

General ordering data

Type	SLS 5.08/09/180B SN OR BX
Order No.	1627310000
Version	PCB plug-in connector, male plug, 5.08 mm, Number of poles: 9, 180°, Clamping yoke connection, Clamping range, max. : 3.31 mm², Box
GTIN (EAN)	4008 190199821
Qty.	36 pc(s).
Product data	IEC: 400 V / 21.5 A / 0.2 - 2.5 mm² UL: 300 V / 14 A / AWG 26 - AWG 12
Packaging	Box

Creation date May 3, 2020 8:20:07 PM CEST

**OMNIMATE Signal - series BL/SL 5.08
SLS 5.08/09/180B SN OR BX**

Weidmüller Interface GmbH & Co. KG
Klingenbergstraße 26
D-32758 Detmold
Germany
Fon: +49 5231 14-0
Fax: +49 5231 14-292083
www.weidmueller.com

Technical data**Dimensions and weights**

Height	15.2 mm	Height (inches)	0.598 inch
Depth	22.3 mm	Depth (inches)	0.878 inch
Net weight	14.68 g		

System Parameters

Product family	OMNIMATE Signal - series BL/SL 5.08	Type of connection	Field connection
Wire connection method	Clamping yoke connection	Pitch in mm (P)	5.08 mm
Pitch in inches (P)	0.2 inch	Conductor outlet direction	180°
Number of poles	9	L1 in mm	40.64 mm
L1 in inches	1.6 inch	Number of rows	1
Pin series quantity	1	Touch-safe protection acc. to DIN VDE 57 106	finger-safe plugged/ back-of-hand-safe unplugged
Volume resistance	≤ 5mΩ	Can be coded	Yes
Stripping length	7 mm	Tightening torque, min.	0.4 Nm
Tightening torque, max.	0.5 Nm	Clamping screw	M 2.5
Screwdriver blade	0.6 x 3.5	Screwdriver blade standard	DIN 5264-A
Plugging cycles	25	Plugging force/pole, max.	4 N
Pulling force/pole, max.	3 N		

Material data

Insulating material	PBT	Colour	orange
Colour chart (similar)	RAL 2000	Insulating material group	IIIa
Comparative Tracking Index (CTI)	≥ 200	Insulation strength	≥ 10 ⁸ Ω
UL 94 flammability rating	V-0	GWFI	960 °C
Contact material	CuSn	Contact surface	tinned
Layer structure of plug contact	4-8 μm Sn hot-dip tinned	Storage temperature, min.	-25 °C
Storage temperature, max.	50 °C	Max. relative humidity during storage	70 %
Operating temperature, min.	-50 °C	Operating temperature, max.	100 °C
Temperature range, installation, min.	-25 °C	Temperature range, installation, max.	100 °C

Conductors suitable for connection

Clamping range, min.	0.13 mm ²
Clamping range, max.	3.31 mm ²
Wire connection cross section AWG, min.	AWG 26
Wire connection cross section AWG, max.	AWG 12
Solid, min. H05(07) V-U	0.2 mm ²
Solid, max. H05(07) V-U	2.5 mm ²
Flexible, min. H05(07) V-K	0.2 mm ²
Flexible, max. H05(07) V-K	2.5 mm ²
w. plastic collar ferrule, DIN 46228 pt 4, 0.2 mm ² min.	
w. plastic collar ferrule, DIN 46228 pt 4, 2.5 mm ² max.	
w. wire end ferrule, DIN 46228 pt 1, min.	0.2 mm ²
w. wire end ferrule, DIN 46228 pt 1, max.	2.5 mm ²
Plug gauge in accordance with EN 60999 a x b; ø	2.8 mm x 2.0 mm; 2.4 mm

Creation date May 3, 2020 8:20:07 PM CEST

**OMNIMATE Signal - series BL/SL 5.08
SLS 5.08/09/180B SN OR BX**

Weidmüller Interface GmbH & Co. KG
Klingenbergstraße 26
D-32758 Detmold
Germany
Fon: +49 5231 14-0
Fax: +49 5231 14-292083
www.weidmueller.com

Technical data

Clampable conductor	Cross-section for conductor connection	Type	fine-wired
		nominal	0.5 mm ²
wire end ferrule		Stripping length	nominal 6 mm
		Recommended wire-end ferrule	H0.5/6
Clampable conductor	Cross-section for conductor connection	Type	fine-wired
		nominal	1 mm ²
wire end ferrule		Stripping length	nominal 6 mm
		Recommended wire-end ferrule	H1.0/6
Clampable conductor	Cross-section for conductor connection	Type	fine-wired
		nominal	1.5 mm ²
wire end ferrule		Stripping length	nominal 7 mm
		Recommended wire-end ferrule	H1.5/7
Clampable conductor	Cross-section for conductor connection	Type	fine-wired
		nominal	2.5 mm ²
wire end ferrule		Stripping length	nominal 7 mm
		Recommended wire-end ferrule	H2.5/7
Clampable conductor	Cross-section for conductor connection	Type	fine-wired
		nominal	0.75 mm ²
wire end ferrule		Stripping length	nominal 6 mm
		Recommended wire-end ferrule	H0.75/6
Reference text	The outside diameter of the plastic collar should not be larger than the pitch (P). Length of ferrules is to be chosen depending on the product and the rated voltage.		
Max. clamping range	3.31 mm ²		

Rated data acc. to IEC

tested acc. to standard	IEC 60664-1, IEC 61984	Rated current, min. number of poles (Tu=20°C)	21.5 A
Rated current, max. number of poles (Tu=20°C)	16 A	Rated current, min. number of poles (Tu=40°C)	18 A
Rated current, max. number of poles (Tu=40°C)	14 A	Rated voltage for surge voltage class / pollution degree II/2	400 V
Rated voltage for surge voltage class / pollution degree III/2	320 V	Rated voltage for surge voltage class / pollution degree III/3	250 V
Rated impulse voltage for surge voltage class/ pollution degree II/2	4 kV	Rated impulse voltage for surge voltage class/ pollution degree III/2	4 kV
Rated impulse voltage for surge voltage class/ contamination degree III/3	4 kV	Short-time withstand current resistance	3 x 1s with 120 A

Rated data acc. to CSA

Institute (CSA)		Certificate No. (CSA)	200039-1121690
Rated voltage (Use group B / CSA)	300 V	Rated voltage (Use group D / CSA)	300 V
Rated current (Use group B / CSA)	15 A	Rated current (Use group D / CSA)	10 A
Wire cross-section, AWG, min.	AWG 26	Wire cross-section, AWG, max.	AWG 12
Reference to approval values	Specifications are maximum values, details - see approval certificate.		

Data sheet

**OMNIMATE Signal - series BL/SL 5.08
SLS 5.08/09/180B SN OR BX**

Weidmüller Interface GmbH & Co. KG
Klingenbergstraße 26
D-32758 Detmold
Germany
Fon: +49 5231 14-0
Fax: +49 5231 14-292083
www.weidmueller.com

Technical data

Rated data acc. to UL 1059

Institute (UR)		Certificate No. (UR)	E60693
Rated voltage (Use group B / UL 1059)	300 V	Rated voltage (Use group D / UL 1059)	300 V
Rated current (Use group B / UL 1059)	14 A	Rated current (Use group D / UL 1059)	10 A
Wire cross-section, AWG, min.	AWG 26	Wire cross-section, AWG, max.	AWG 12
Reference to approval values	Specifications are maximum values, details - see approval certificate.		

Packing

Packaging	Box	VPE length	30 mm
VPE width	135 mm	VPE height	350 mm

Classifications

ETIM 6.0	EC002638	ETIM 7.0	EC002638
eClass 9.0	27-44-03-09	eClass 9.1	27-44-03-09
eClass 10.0	27-44-03-09	UNSPSC	30-21-18-10

Notes

Notes	<ul style="list-style-type: none"> • Additional colours on request • Rated current related to rated cross-section & min. No. of poles. • Wire end ferrule without plastic collar to DIN 46228/1 • Wire end ferrule with plastic collar to DIN 46228/4 • P on drawing = pitch • Rated data refer only to the component itself. Clearance and creepage distances to other components are to be designed in accordance with the relevant application standards.
-------	--

IPC conformity	Conformity: The products are developed, manufactured and delivered according international recognized standards and norms and comply with the assured properties in the data sheet resp. fulfill decorative properties in accordance with IPC-A-610 "Class 2". Further claims on the products can be evaluated on request.
----------------	--

Approvals

Approvals	
ROHS	Conform

Data sheet**OMNIMATE Signal - series BL/SL 5.08
SLS 5.08/09/180B SN OR BX**

Weidmüller Interface GmbH & Co. KG
Klingenbergstraße 26
D-32758 Detmold
Germany
Fon: +49 5231 14-0
Fax: +49 5231 14-292083
www.weidmueller.com

Technical data**Downloads**

Approval/Certificate/Document of Conformity	Declaration of the Manufacturer
Brochure/Catalogue	FL DRIVES EN MB DEVICE MANUF. EN FL DRIVES DE CAT 2 PORTFOLIOGUIDE EN FL BUILDING SAFETY EN FL APPL LED LIGHTING EN FL INDUSTR.CONTROLS EN FL MACHINE SAFETY EN FL HEATING ELECTR EN FL APPL INVERTER EN FL BASE STATION EN FL ELEVATOR EN FL POWER SUPPLY EN FL 72H SAMPLE SER EN PO OMNIMATE EN
Engineering Data	WSCAD
Engineering Data	STEP

Data sheet

**OMNIMATE Signal - series BL/SL 5.08
SLS 5.08/09/180B SN OR BX**

Weidmüller Interface GmbH & Co. KG
Klingenbergstraße 26
D-32758 Detmold
Germany
Fon: +49 5231 14-0
Fax: +49 5231 14-292083
www.weidmueller.com

Drawings

Dimensional drawing

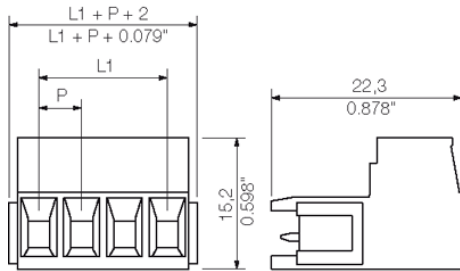

Graph

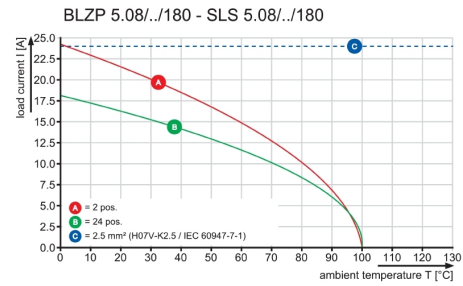

Graph

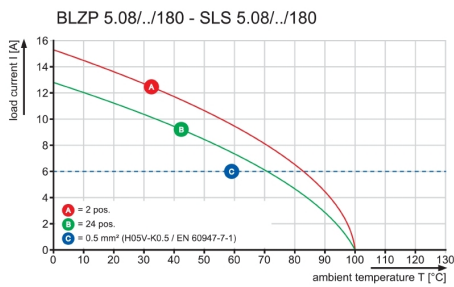

Graph

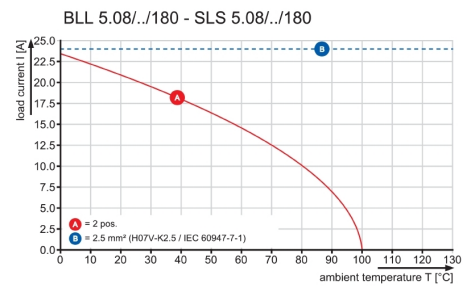

Product benefits

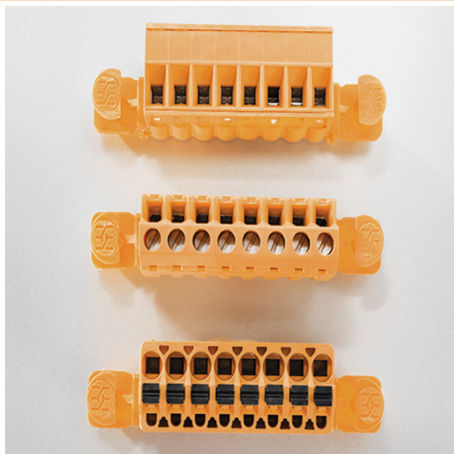

Flexible application options
For 3 connection systems

**OMNIMATE Signal - series BL/SL 5.08
SLS 5.08/09/180B SN OR BX**

Weidmüller Interface GmbH & Co. KG
 Klingenbergstraße 26
 D-32758 Detmold
 Germany
 Fon: +49 5231 14-0
 Fax: +49 5231 14-292083
 www.weidmueller.com

Mating connector (conditionally pluggable)
BLL 5.08/180

Female header for PCB mounting. The solder pin length is optimised for wave flow soldering.

General ordering data

Type	BLL 5.08/09/180 4.5SN B ...	Version	Product data	Packaging
Order No.	1646320000	PCB plug-in connector, female header, closed side, THT solder	IEC: 400 V / 23 A	Box
GTIN (EAN)	4008190285661	connection, 5.08 mm, Number of poles: 9, 180°, Solder pin length (l):	UL: 300 V / 15 A	
Qty.	50 pc(s).	4.5 mm, tinned, black, Box		
Type	BLL 5.08/09/180 4.5SN O ...	Version	Product data	Packaging
Order No.	1646210000	PCB plug-in connector, female header, closed side, THT solder	IEC: 400 V / 23 A	Box
GTIN (EAN)	4008190285555	connection, 5.08 mm, Number of poles: 9, 180°, Solder pin length (l):	UL: 300 V / 15 A	
Qty.	50 pc(s).	4.5 mm, tinned, orange, Box		

**OMNIMATE Signal - series BL/SL 5.08
SLS 5.08/09/180B SN OR BX**

Weidmüller Interface GmbH & Co. KG
Klingenbergstraße 26
D-32758 Detmold
Germany
Fon: +49 5231 14-0
Fax: +49 5231 14-292083
www.weidmueller.com

Mating connector (fully pluggable)
BLZP 5.08HC/225 SN

Clamping-yoke connection with right-angled (90° or 270°) or angled (225°) outlet direction. The female connectors provide space for labelling and can be coded. Fastened by means of a flange or release latch. They also provide an integrated plus/minus screw, protection against faulty insertion of the wire, and they are delivered with open clamping yokes. HC = High Current.

General ordering data

Type	BLZP 5.08HC/09/225 SN B ...	Version	Product data	Packaging
Order No.	1946630000	PCB plug-in connector, female plug, 5.08 mm, Number of poles: 9,	IEC: 400 V / 17.5 A / 0.2 - 4 mm ²	Box
GTIN (EAN)	4032248622405	225°, Clamping yoke connection, Clamping range, max. : 4 mm ² , Box	UL: 300 V / 15 A / AWG 26 - AWG 12	
Qty.	36 pc(s).			
Type	BLZP 5.08HC/09/225 SN O ...	Version	Product data	Packaging
Order No.	1946320000	PCB plug-in connector, female plug, 5.08 mm, Number of poles: 9,	IEC: 400 V / 17.5 A / 0.2 - 4 mm ²	Box
GTIN (EAN)	4032248621897	225°, Clamping yoke connection, Clamping range, max. : 4 mm ² , Box	UL: 300 V / 15 A / AWG 26 - AWG 12	
Qty.	36 pc(s).			

BLZP 5.08HC/270 SN

Female plugs with clamping-yoke connection for connecting wires with a right-angle (90° or 270°) outlet direction. The female connectors provide space for labelling and can be coded. Fastened by means of a flange or release latch. They also provide an integrated plus/minus screw, protection against faulty insertion of the wire, and they are delivered with open clamping yokes. HC = High Current.

General ordering data

Type	BLZP 5.08HC/09/270 SN B ...	Version	Product data	Packaging
Order No.	1949090000	PCB plug-in connector, female plug, 5.08 mm, Number of poles: 9,	IEC: 400 V / 23 A / 0.2 - 4 mm ²	Box
GTIN (EAN)	4032248626540	270°, Clamping yoke connection, Clamping range, max. : 4 mm ² , Box	UL: 300 V / 20 A / AWG 26 - AWG 12	
Qty.	36 pc(s).			
Type	BLZP 5.08HC/09/270 SN O ...	Version	Product data	Packaging
Order No.	1948860000	PCB plug-in connector, female plug, 5.08 mm, Number of poles: 9,	IEC: 400 V / 23 A / 0.2 - 4 mm ²	Box
GTIN (EAN)	4032248626311	270°, Clamping yoke connection, Clamping range, max. : 4 mm ² , Box	UL: 300 V / 20 A / AWG 26 - AWG 12	
Qty.	36 pc(s).			

**OMNIMATE Signal - series BL/SL 5.08
SLS 5.08/09/180B SN OR BX**

Weidmüller Interface GmbH & Co. KG
Klingenbergstraße 26
D-32758 Detmold
Germany
Fon: +49 5231 14-0
Fax: +49 5231 14-292083
www.weidmueller.com

Mating connector (fully pluggable)
BLF 5.08HC/180DF SN

Just as reliable as the millionfold proven original and featuring innovative details:

The BLF 5.08HC PUSH IN version of the BLZP 5.08HC female connector is not only different in terms of connection system; it also has a more compact design. Weidmüller's innovative PUSH IN spring connection system stands for the future of easy and tool-free wire connection. HC = High Current.

In terms of versatility, the BLF 5.08HC offers just as much as the version which served as a model:

- 3 tested-and-proven wire outlet directions provide the usual flexibility for application-specific design
- 4 flange variations and the patented release latch allow the locking concept to be based on the requirements of the user
- Use the BLF 5.08HC and SL 5.08HC plug combination to reach the max. rated specifications

General ordering data

Type	BLF 5.08HC/09/180DF SN ...	Version	Product data	Packaging
Order No.	1353320000	PCB plug-in connector, female plug, 5.08 mm, Number of poles: 9,	IEC: 400 V / 24 A / 0.2 - 2.5 mm ²	Box
GTIN (EAN)	4050118155921	180°, PUSH IN, Spring connection, Clamping range, max. : 3.31 mm ² , UL: 300 V / 18.5 A / AWG 26 - AWG		
Qty.	24 pc(s).	Box	12	

BLZP 5.08HC/180 SN

Female plug with clamping-yoke screw system for connecting wires with straight (180°) outlet direction. The female connectors provide space for labelling and can be coded. Fastened by means of a flange or release latch. They also provide an integrated plus/minus screw, protection against faulty insertion of the wire, and they are delivered with open clamping yokes. HC = High Current.

General ordering data

Type	BLZP 5.08HC/09/180 SN O ...	Version	Product data	Packaging
Order No.	1943650000	PCB plug-in connector, female plug, 5.08 mm, Number of poles: 9,	IEC: 400 V / 23 A / 0.2 - 4 mm ²	Box
GTIN (EAN)	4032248617661	180°, Clamping yoke connection, Clamping range, max. : 4 mm ² , Box	UL: 300 V / 20 A / AWG 26 - AWG 12	
Qty.	36 pc(s).			
Type	BLZP 5.08HC/09/180 SN B ...	Version	Product data	Packaging
Order No.	1943880000	PCB plug-in connector, female plug, 5.08 mm, Number of poles: 9,	IEC: 400 V / 23 A / 0.2 - 4 mm ²	Box
GTIN (EAN)	4032248617982	180°, Clamping yoke connection, Clamping range, max. : 4 mm ² , Box	UL: 300 V / 20 A / AWG 26 - AWG 12	
Qty.	36 pc(s).			

**OMNIMATE Signal - series BL/SL 5.08
SLS 5.08/09/180B SN OR BX**

Weidmüller Interface GmbH & Co. KG
Klingenbergstraße 26
D-32758 Detmold
Germany
Fon: +49 5231 14-0
Fax: +49 5231 14-292083
www.weidmuller.com

Mating connector (fully pluggable)**BLF 5.08HC/180 SN**

Just as reliable as the millionfold proven original and featuring innovative details:

The BLF 5.08HC PUSH IN version of the BLZP 5.08HC female connector is not only different in terms of connection system; it also has a more compact design. Weidmüller's innovative PUSH IN spring connection system stands for the future of easy and tool-free wire connection. HC = High Current.

In terms of versatility, the BLF 5.08HC offers just as much as the version which served as a model:

- 3 tested-and-proven wire outlet directions provide the usual flexibility for application-specific design
- 4 flange variations and the patented release latch allow the locking concept to be based on the requirements of the user
- Use the BLF 5.08HC and SL 5.08HC plug combination to reach the max. rated specifications

General ordering data

Type	BLF 5.08HC/09/180 SN OR ...	Version	Product data	Packaging
Order No.	1013760000	PCB plug-in connector, female plug, 5.08 mm, Number of poles: 9,	IEC: 400 V / 24 A / 0.2 - 2.5 mm ²	Box
GTIN (EAN)	4032248721870	180°, PUSH IN, Spring connection, Clamping range, max. : 3.31 mm ² , UL: 300 V / 18.5 A / AWG 26 - AWG		
Qty.	36 pc(s).	Box	12	
Type	BLF 5.08HC/09/180 SN BK ...	Version	Product data	Packaging
Order No.	1013510000	PCB plug-in connector, female plug, 5.08 mm, Number of poles: 9,	IEC: 400 V / 24 A / 0.2 - 2.5 mm ²	Box
GTIN (EAN)	4032248721658	180°, PUSH IN, Spring connection, Clamping range, max. : 3.31 mm ² , UL: 300 V / 18.5 A / AWG 26 - AWG		
Qty.	36 pc(s).	Box	12	

BLZP 5.08HC/90 SN

Female plugs with clamping-yoke connection for connecting wires with a right-angle (90° or 270°) outlet direction. The female connectors provide space for labelling and can be coded. Fastened by means of a flange or release latch. They also provide an integrated plus/minus screw, protection against faulty insertion of the wire, and they are delivered with open clamping yokes. HC = High Current.

General ordering data

Type	BLZP 5.08HC/09/90 SN BK ...	Version	Product data	Packaging
Order No.	1948310000	PCB plug-in connector, female plug, 5.08 mm, Number of poles: 9,	IEC: 400 V / 23 A / 0.2 - 4 mm ²	Box
GTIN (EAN)	4032248624836	90°, Clamping yoke connection, Clamping range, max. : 4 mm ² , Box	UL: 300 V / 20 A / AWG 26 - AWG 12	
Qty.	36 pc(s).			
Type	BLZP 5.08HC/09/90 SN OR ...	Version	Product data	Packaging
Order No.	1948070000	PCB plug-in connector, female plug, 5.08 mm, Number of poles: 9,	IEC: 400 V / 23 A / 0.2 - 4 mm ²	Box
GTIN (EAN)	4032248624294	90°, Clamping yoke connection, Clamping range, max. : 4 mm ² , Box	UL: 300 V / 20 A / AWG 26 - AWG 12	
Qty.	36 pc(s).			

**OMNIMATE Signal - series BL/SL 5.08
SLS 5.08/09/180B SN OR BX**

Weidmüller Interface GmbH & Co. KG
Klingenbergstraße 26
D-32758 Detmold
Germany
Fon: +49 5231 14-0
Fax: +49 5231 14-292083
www.weidmueller.com

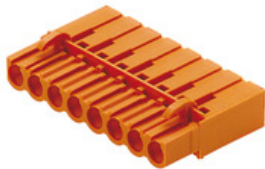
Mating connector (fully pluggable)
BLC 5.08R

Female plugs with crimp wire connection system. The female plugs provide space for labelling and can be coded.

General ordering data

Type	BLC 5.08/09/180R BK BX	Version	Product data	Packaging
Order No.	1712030000	PCB plug-in connector, female plug, 5.08 mm, Number of poles: 9,	IEC: 400 V / 21 A	Box
GTIN (EAN)	4008190935047	180°, Crimp connection, Clamping range, max. : 2.5 mm ² , Box	UL: 300 V / 10 A / AWG 26 - AWG 14	
Qty.	50 pc(s).			
Type	BLC 5.08/09/180R OR BX	Version	Product data	Packaging
Order No.	1610560000	PCB plug-in connector, female plug, 5.08 mm, Number of poles: 9,	IEC: 400 V / 21 A	Box
GTIN (EAN)	4008190158606	180°, Crimp connection, Clamping range, max. : 2.5 mm ² , Box	UL: 300 V / 10 A / AWG 26 - AWG 14	
Qty.	50 pc(s).			

BLF 5.08HC/90 SN

Just as reliable as the millionfold proven original and featuring innovative details:
The BLF 5.08HC PUSH IN version of the BLZP 5.08HC female connector is not only different in terms of connection system; it also has a more compact design. Weidmüller's innovative PUSH IN spring connection system stands for the future of easy and tool-free wire connection. HC = High Current.
In terms of versatility, the BLF 5.08HC offers just as much as the version which served as a model:

- 3 tested-and-proven wire outlet directions provide the usual flexibility for application-specific design
- 4 flange variations and the patented release latch allow the locking concept to be based on the requirements of the user
- Use the BLF 5.08HC and SL 5.08HC plug combination to reach the max. rated specifications

General ordering data

Type	BLF 5.08HC/09/90 SN BK ...	Version	Product data	Packaging
Order No.	1000100001	PCB plug-in connector, female plug, 5.08 mm, Number of poles: 9,	IEC: 400 V / 24 A / 0.2 - 2.5 mm ²	Box
GTIN (EAN)	4032248690039	90°, PUSH IN, Spring connection, Clamping range, max. : 3.31 mm ² ,	UL: 300 V / 18.5 A / AWG 26 - AWG 12	
Qty.	36 pc(s).	Box		
Type	BLF 5.08HC/09/90 SN OR ...	Version	Product data	Packaging
Order No.	1001600000	PCB plug-in connector, female plug, 5.08 mm, Number of poles: 9,	IEC: 400 V / 24 A / 0.2 - 2.5 mm ²	Box
GTIN (EAN)	4032248693405	90°, PUSH IN, Spring connection, Clamping range, max. : 3.31 mm ² ,	UL: 300 V / 18.5 A / AWG 26 - AWG 12	
Qty.	36 pc(s).	Box		

**OMNIMATE Signal - series BL/SL 5.08
SLS 5.08/09/180B SN OR BX**

Weidmüller Interface GmbH & Co. KG
Klingenbergstraße 26
D-32758 Detmold
Germany
Fon: +49 5231 14-0
Fax: +49 5231 14-292083
www.weidmuller.com

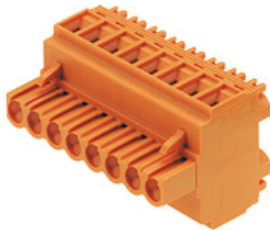
Mating connector (fully pluggable)
BLDT 5.08

Female plugs with two clamping-yoke screw connections per pole for wire connections with 90° and 270° outlet directions. The female plugs provide space for labelling and can be coded.

General ordering data

Type	BLDT 5.08/09/- SN BK BX	Version	Product data	Packaging
Order No.	1660780000	PCB plug-in connector, female plug, 5.08 mm, Number of poles: 9,	IEC: 400 V / 14 A / 0.2 - 2.5 mm ²	Box
GTIN (EAN)	4008190417239	180°, Clamping yoke connection, Clamping range, max. : 3.31 mm ² ,	UL: 300 V / 10 A / AWG 26 - AWG 12	
Qty.	30 pc(s).	Box		
Type	BLDT 5.08/09/- SN OR BX	Version	Product data	Packaging
Order No.	1644800000	PCB plug-in connector, female plug, 5.08 mm, Number of poles: 9,	IEC: 400 V / 14 A / 0.2 - 2.5 mm ²	Box
GTIN (EAN)	4008190284015	180°, Clamping yoke connection, Clamping range, max. : 3.31 mm ² ,	UL: 300 V / 10 A / AWG 26 - AWG 12	
Qty.	30 pc(s).	Box		

BLF 5.08HC/270 SN

Just as reliable as the millionfold proven original and featuring innovative details:
The BLF 5.08HC PUSH IN version of the BLZP 5.08HC female connector is not only different in terms of connection system; it also has a more compact design. Weidmüller's innovative PUSH IN spring connection system stands for the future of easy and tool-free wire connection. HC = High Current.
In terms of versatility, the BLF 5.08HC offers just as much as the version which served as a model:

- 3 tested-and-proven wire outlet directions provide the usual flexibility for application-specific design
- 4 flange variations and the patented release latch allow the locking concept to be based on the requirements of the user
- Use the BLF 5.08HC and SL 5.08HC plug combination to reach the max. rated specifications

General ordering data

Type	BLF 5.08HC/09/270 SN BK ...	Version	Product data	Packaging
Order No.	1982000000	PCB plug-in connector, female plug, 5.08 mm, Number of poles: 9,	IEC: 400 V / 24 A / 0.2 - 2.5 mm ²	Box
GTIN (EAN)	4032248684694	270°, PUSH IN, Spring connection, Clamping range, max. : 3.31 mm ² ,	UL: 300 V / 18.5 A / AWG 26 - AWG 12	
Qty.	36 pc(s).	Box		
Type	BLF 5.08HC/09/270 SN OR ...	Version	Product data	Packaging
Order No.	1982770000	PCB plug-in connector, female plug, 5.08 mm, Number of poles: 9,	IEC: 400 V / 24 A / 0.2 - 2.5 mm ²	Box
GTIN (EAN)	4032248686865	270°, PUSH IN, Spring connection, Clamping range, max. : 3.31 mm ² ,	UL: 300 V / 18.5 A / AWG 26 - AWG 12	
Qty.	36 pc(s).	Box		

**OMNIMATE Signal - series BL/SL 5.08
SLS 5.08/09/180B SN OR BX**

Weidmüller Interface GmbH & Co. KG
Klingenbergstraße 26
D-32758 Detmold
Germany
Fon: +49 5231 14-0
Fax: +49 5231 14-292083
www.weidmueller.com

Mating connector (fully pluggable)
BLZP 5.08HC/225B SN

Clamping-yoke connection with right-angled (90° or 270°) or angled (225°) outlet direction. The female connectors provide space for labelling and can be coded. Fastened by means of a flange or release latch. They also provide an integrated plus/minus screw, protection against faulty insertion of the wire, and they are delivered with open clamping yokes. HC = High Current.

General ordering data

Type	BLZP 5.08HC/09/225B SN ...	Version	Product data	Packaging
Order No.	1945820000	PCB plug-in connector, female plug, 5.08 mm, Number of poles: 9,	IEC: 400 V / 17.5 A / 0.2 - 4 mm ²	Box
GTIN (EAN)	4032248621293	225°, Clamping yoke connection, Clamping range, max. : 4 mm ² , Box	UL: 300 V / 15 A / AWG 26 - AWG 12	
Qty.	36 pc(s).			
Type	BLZP 5.08HC/09/225B SN ...	Version	Product data	Packaging
Order No.	1946050000	PCB plug-in connector, female plug, 5.08 mm, Number of poles: 9,	IEC: 400 V / 17.5 A / 0.2 - 4 mm ²	Box
GTIN (EAN)	4032248621583	225°, Clamping yoke connection, Clamping range, max. : 4 mm ² , Box	UL: 300 V / 15 A / AWG 26 - AWG 12	
Qty.	36 pc(s).			

BLL 5.08/180

Female header for PCB mounting. The solder pin length is optimised for wave flow soldering.

General ordering data

Type	BLL 5.08/09/180 3.2 SN ...	Version	Product data	Packaging
Order No.	1630780000	PCB plug-in connector, female header, closed side, THT solder	IEC: 400 V / 23 A	Box
GTIN (EAN)	4008190204204	connection, 5.08 mm, Number of poles: 9, 180°, Solder pin length (!):	UL: 300 V / 15 A	
Qty.	36 pc(s).	3.2 mm, tinned, orange, Box		

**OMNIMATE Signal - series BL/SL 5.08
SLS 5.08/09/180B SN OR BX**

Weidmüller Interface GmbH & Co. KG
Klingenbergstraße 26
D-32758 Detmold
Germany
Fon: +49 5231 14-0
Fax: +49 5231 14-292083
www.weidmueller.com

Mating connector (fully pluggable)
BLL 5.08/90

Female header for PCB mounting. The solder pin length is optimised for wave flow soldering.

General ordering data

Type	BLL 5.08/09/90 3.2 SN O ...	Version	Product data	Packaging
Order No.	1623010000	PCB plug-in connector, female header, closed side, THT solder connection, 5.08 mm, Number of poles: 9, 90°, Solder pin length (l): 3.2 mm, tinned, orange, Box	IEC: 400 V / 23 A UL: 300 V / 15 A	Box
GTIN (EAN)	4008190194062			
Qty.	36 pc(s).			

BLDT 5.08B



Female plugs with two clamping-yoke screw connections per pole for wire connections with 90° and 270° outlet directions. The female plugs provide space for labelling and can be coded.

General ordering data

Type	BLDT 5.08/09/-B SN BK BX	Version	Product data	Packaging
Order No.	1673850000	PCB plug-in connector, female plug, 5.08 mm, Number of poles: 9, 180°, Clamping yoke connection, Clamping range, max. : 3.31 mm², Box	IEC: 400 V / 14 A / 0.2 - 2.5 mm² UL: 300 V / 10 A / AWG 26 - AWG 12	Box
GTIN (EAN)	4008190435585			
Qty.	30 pc(s).			
Type	BLDT 5.08/09/-B SN OR BX	Version	Product data	Packaging
Order No.	1651810000	PCB plug-in connector, female plug, 5.08 mm, Number of poles: 9, 180°, Clamping yoke connection, Clamping range, max. : 3.31 mm², Box	IEC: 400 V / 14 A / 0.2 - 2.5 mm² UL: 300 V / 10 A / AWG 26 - AWG 12	Box
GTIN (EAN)	4008190400491			
Qty.	30 pc(s).			

**OMNIMATE Signal - series BL/SL 5.08
SLS 5.08/09/180B SN OR BX**

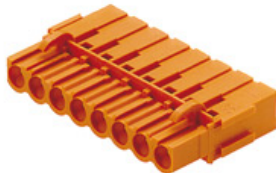
Weidmüller Interface GmbH & Co. KG
Klingenbergstraße 26
D-32758 Detmold
Germany
Fon: +49 5231 14-0
Fax: +49 5231 14-292083
www.weidmueller.com

Mating connector (fully pluggable)
BLC 5.08BR

Female plugs with crimp wire connection system. The female plugs provide space for labelling and can be coded.

General ordering data

Type	BLC 5.08/09/180BR BK BX	Version	Product data	Packaging
Order No.	1712180000	PCB plug-in connector, female plug, 5.08 mm, Number of poles: 9,	IEC: 400 V / 21 A	Box
GTIN (EAN)	4008190935191	180°, Crimp connection, Clamping range, max. : 2.5 mm ² , Box	UL: 300 V / 10 A / AWG 26 - AWG 14	
Qty.	50 pc(s).			
Type	BLC 5.08/09/180BR OR BX	Version	Product data	Packaging
Order No.	1649440000	PCB plug-in connector, female plug, 5.08 mm, Number of poles: 9,	IEC: 400 V / 21 A	Box
GTIN (EAN)	4008190294557	180°, Crimp connection, Clamping range, max. : 2.5 mm ² , Box	UL: 300 V / 10 A / AWG 26 - AWG 14	
Qty.	50 pc(s).			

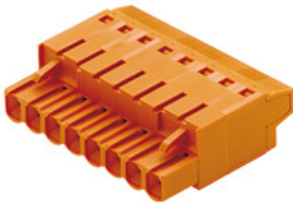
BLT 5.08HC/180B

Female plugs with TOP screw connection system for connecting wires with straight 180° outlet direction. The female connectors provide space for labelling and can be coded. HC = High Current.

General ordering data

Type	BLT 5.08HC/09/180B SN O ...	Version	Product data	Packaging
Order No.	1502560000	PCB plug-in connector, female plug, 5.08 mm, Number of poles: 9,	IEC: 400 V / 27 A / 0.2 - 2.5 mm ²	Box
GTIN (EAN)	4008190171117	180°, TOP connection, Clamping range, max. : 2.5 mm ² , Box	UL: 300 V / 17 A / AWG 26 - AWG 14	
Qty.	36 pc(s).			

**OMNIMATE Signal - series BL/SL 5.08
SLS 5.08/09/180B SN OR BX**

Weidmüller Interface GmbH & Co. KG
Klingenbergstraße 26
D-32758 Detmold
Germany
Fon: +49 5231 14-0
Fax: +49 5231 14-292083
www.weidmueller.com

Mating connector (fully pluggable)

BLL 5.08/180B



Female header for PCB mounting. The solder pin length is optimised for wave flow soldering.

General ordering data

Type	BLL 5.08/09/180B 3.2SN ...	Version	Product data	Packaging
Order No.	1682800000	PCB plug-in connector, female header, Dovetails for fixing blocks, THT	IEC: 400 V / 23 A	Box
GTIN (EAN)	4008190474560	solder connection, 5.08 mm, Number of poles: 9, 180°, Solder pin	UL: 300 V / 15 A	
Qty.	36 pc(s).	length (l): 3.2 mm, tinned, orange, Box		

OMNIMATE Signal - series BL/SL 5.08 SLS 5.08/09/180B SN OR BX

Weidmüller Interface GmbH & Co. KG
 Klingenbergstraße 26
 D-32758 Detmold
 Germany
 Fon: +49 5231 14-0
 Fax: +49 5231 14-292083
 www.weidmueller.com

Accessories

Coding elements



**Only connects what is supposed to be connected:
the right connection at the right place.**

Coding elements and locking devices clearly assign connecting elements during the manufacturing process and operation

The coding elements and locking devices are inserted prior to assembly or during the cable assembly phase. The Weidmüller alternative: configure online using the variant configurator to precode prior to delivery.

Incorrect assembly on the circuit board and incorrect plugging of connecting elements is no longer possible. The advantage: no troubleshooting during manufacture and no operational errors by the user.

General ordering data

Type	BLZ/SL KO BK BX	Version	Product data	Packaging
Order No.	1545710000	PCB plug-in connector, Accessories, Coding element, black, Number		Box
GTIN (EAN)	4008190087142	of poles: 1		
Qty.	50 pc(s).			
Type	BLZ/SL KO OR BX	Version	Product data	Packaging
Order No.	1573010000	PCB plug-in connector, Accessories, Coding element, orange, Number		Box
GTIN (EAN)	4008190048396	of poles: 1		
Qty.	100 pc(s).			

Blocks for PCB mounting



Minor component, major effect:

Clip-on attachment elements increase the mechanical resilience of the whole plug connection by

- securing the male connectors to the circuit board
- providing a vibration-proof connection between the sockets and the male connectors

Clip-on or pre-assembled - always the right solution:

- Hard-wearing, precise fitting dovetail joint
- Hard-wearing metal threaded inserts
- Suitable for all outlet directions

Maximum stability, minimum effort:

- Extremely resilient for frequent fastening operations
- Complete set for easy selection

The result: soldering points, contacts and overall module are more resilient against mechanical stress such as vibrations and tensile loads.

General ordering data

Type	SLA BB6R OR	Version	Product data	Packaging
Order No.	1723470000	PCB plug-in connector, Accessories, Mounting block, orange, Number		Box
GTIN (EAN)	4008190366025	of poles: 1		
Qty.	20 pc(s).			

**OMNIMATE Signal - series BL/SL 5.08
SLS 5.08/09/180B SN OR BX**

Weidmüller Interface GmbH & Co. KG
Klingenbergstraße 26
D-32758 Detmold
Germany
Fon: +49 5231 14-0
Fax: +49 5231 14-292083
www.weidmueller.com

Accessories

Type	SLA BB6R SW	Version	Product data	Packaging
Order No.	1723520000	PCB plug-in connector, Accessories, Mounting block, black, Number of		Box
GTIN (EAN)	4008190366070	poles: 1		
Qty.	20 pc(s).			
Type	SLA BB5R OR	Version	Product data	Packaging
Order No.	1723460000	PCB plug-in connector, Accessories, Mounting block, orange, Number		Box
GTIN (EAN)	4008190366018	of poles: 1		
Qty.	20 pc(s).			
Type	SLA BB11R SW	Version	Product data	Packaging
Order No.	1692340000	PCB plug-in connector, Accessories, Mounting block, black, Number of		Box
GTIN (EAN)	4008190864965	poles: 1		
Qty.	20 pc(s).			
Type	SLA BB11R OR	Version	Product data	Packaging
Order No.	1604120000	PCB plug-in connector, Accessories, Mounting block, orange, Number		Box
GTIN (EAN)	4008190182977	of poles: 1		
Qty.	20 pc(s).			
Type	SLA BB1R OR	Version	Product data	Packaging
Order No.	1723430000	PCB plug-in connector, Accessories, Mounting block, orange, Number		Box
GTIN (EAN)	4008190365981	of poles: 1		
Qty.	20 pc(s).			
Type	SLA BB1R SW	Version	Product data	Packaging
Order No.	1723480000	PCB plug-in connector, Accessories, Mounting block, black, Number of		Box
GTIN (EAN)	4008190366032	poles: 1		
Qty.	20 pc(s).			
Type	SLA BB5R SW	Version	Product data	Packaging
Order No.	1723510000	PCB plug-in connector, Accessories, Mounting block, black, Number of		Box
GTIN (EAN)	4008190366063	poles: 1		
Qty.	20 pc(s).			
Type	SLA BB2R OR	Version	Product data	Packaging
Order No.	1723440000	PCB plug-in connector, Accessories, Mounting block, orange, Number		Box
GTIN (EAN)	4008190365998	of poles: 1		
Qty.	20 pc(s).			
Type	SLA BB12R SW	Version	Product data	Packaging
Order No.	1626880000	PCB plug-in connector, Accessories, Mounting block, black, Number of		Box
GTIN (EAN)	4008190198213	poles: 1		
Qty.	100 pc(s).			
Type	SLA BB2R SW	Version	Product data	Packaging
Order No.	1723490000	PCB plug-in connector, Accessories, Mounting block, black, Number of		Box
GTIN (EAN)	4008190366049	poles: 1		
Qty.	20 pc(s).			
Type	SLA BB12R OR	Version	Product data	Packaging
Order No.	1593450000	PCB plug-in connector, Accessories, Mounting block, orange, Number		Box
GTIN (EAN)	4008190122164	of poles: 1		
Qty.	100 pc(s).			

MASSE OHNE TOLERANZ SIND KEINE PRUEFMASSE
 DIMS. WITHOUT TOLERANCE ARE NOT CONTROL DIMS.

ALLGEMEINGUELTIGE KUNDENZEICHNUNG, AKTUELLER STAND NUR AUF ANFRAGE
 GENERAL CUSTOMER DRAWING, TOPICAL VERSION ONLY IF REQUIRED

DIE DEUTSCHE VERSION IST VERBINDLICH
 THE GERMAN VERSION IS BINDING

SHOWN: SLS 5.08/04/180

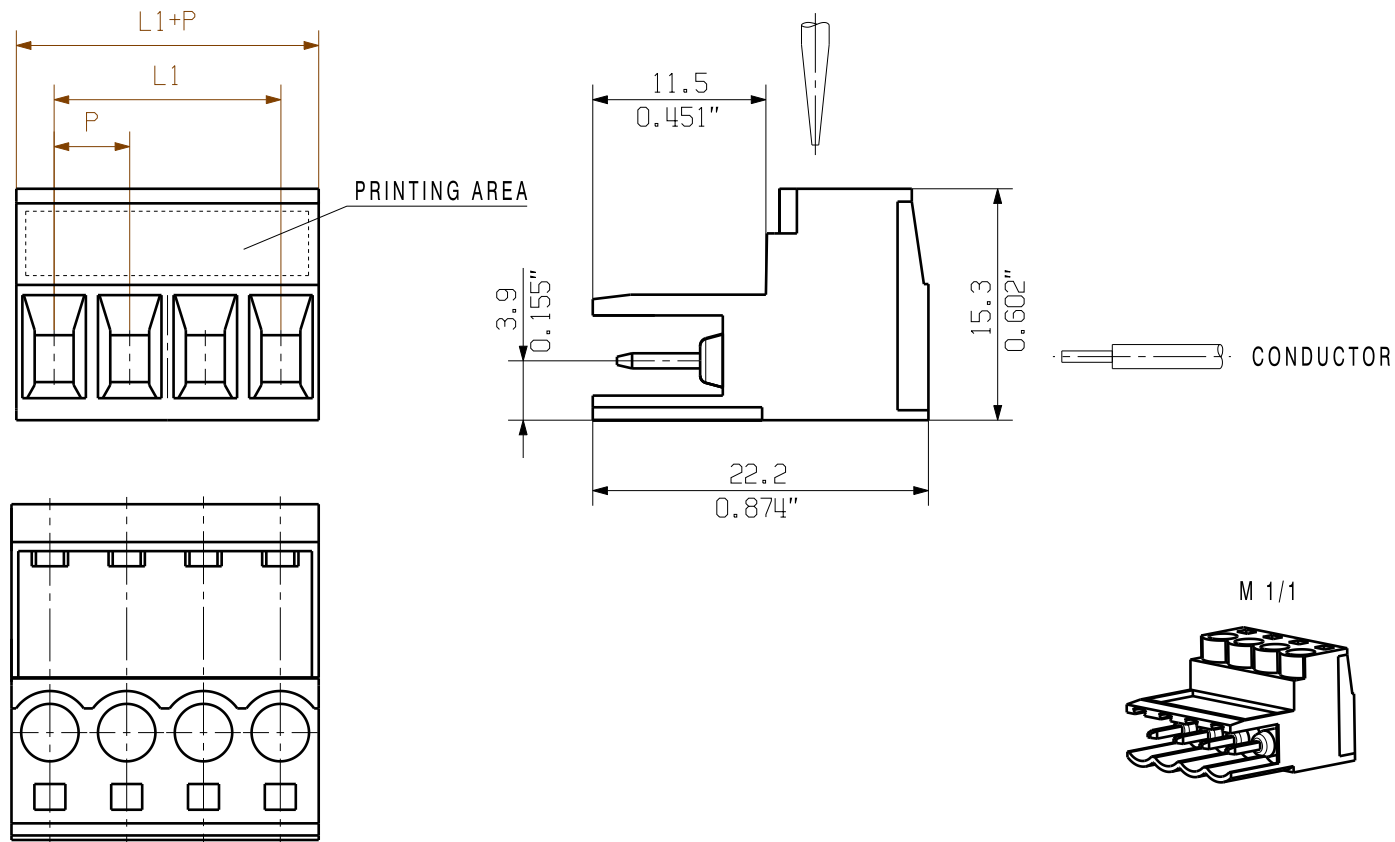

SHOWN: SLS 5.08/04/180DF

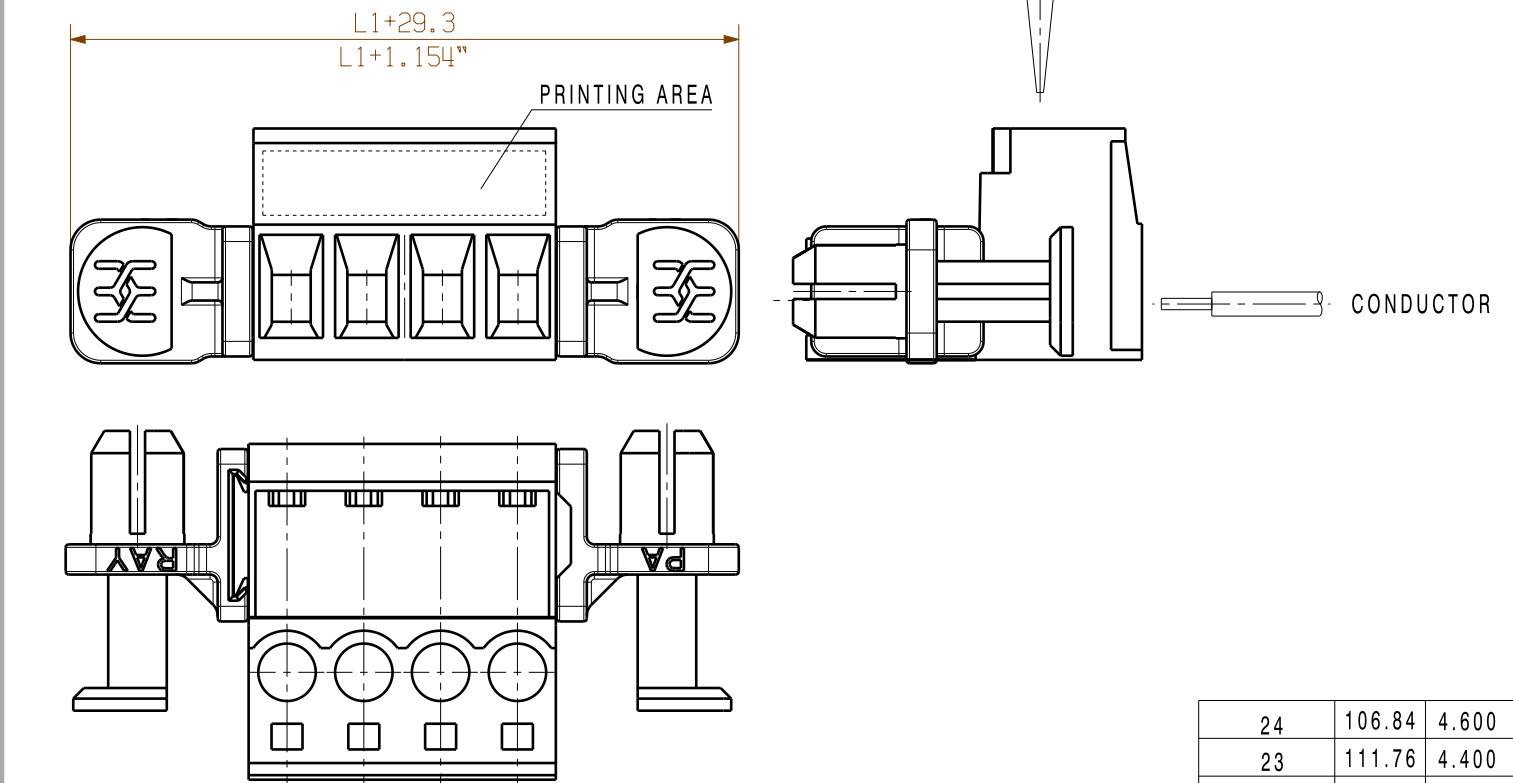

SHOWN: SLS 5.08/04/180B

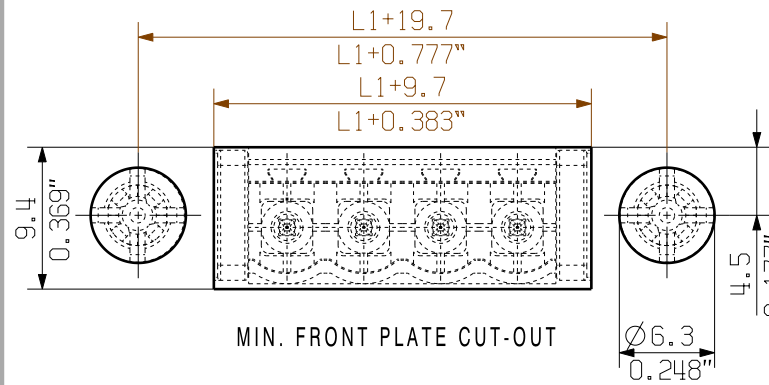
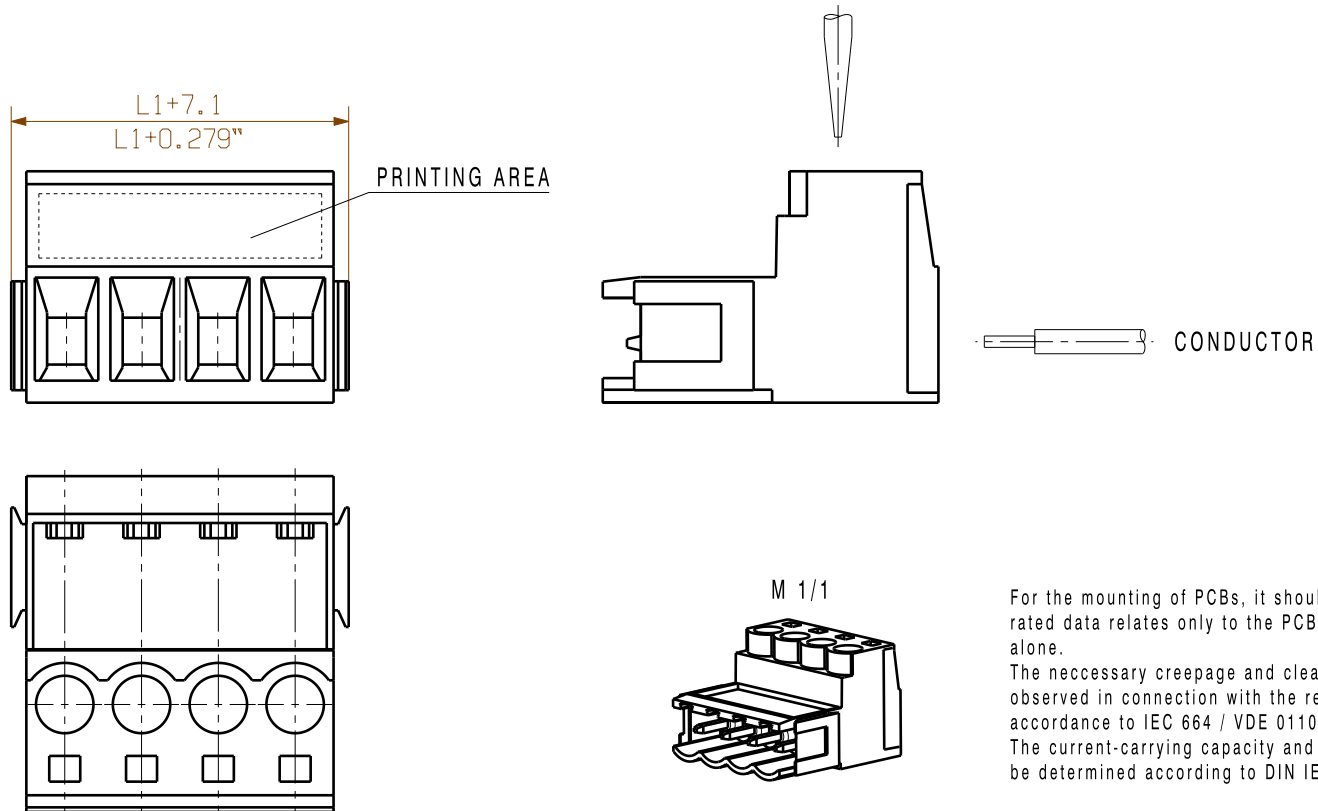

0.5-0.8	0.019-0.031	6.3	0.248
1.00	0.039	6.4	0.252
1.5	0.059	6.5	0.256
2.00	0.079	6.7	0.264
WANDDICKE WALL THICKNESS [mm]	WANDDICKE WALL THICKNESS [inch]	d [mm]	d [inch]

24	106.84	4.600
23	111.76	4.400
22	106.68	4.200
21	101.60	4.000
20	96.52	3.800
19	91.44	3.600
18	86.36	3.400
17	81.28	3.200
16	76.20	3.000
15	71.12	2.800
14	66.04	2.600
13	60.96	2.400
12	55.88	2.200
11	50.80	2.000
10	45.72	1.800
9	40.64	1.600
8	35.56	1.400
7	30.48	1.200
6	25.40	1.000
5	20.32	0.800
4	15.24	0.600
3	10.16	0.400
2	5.08	0.200
n POLES	L1 [mm]	L1 [inch]

For the mounting of PCBs, it should be noted that the rated data relates only to the PCB components alone.
 The necessary creepage and clearance paths must be observed in connection with the respective applicant in accordance to IEC 664 / VDE 0110.
 The current-carrying capacity and pitch tolerance is to be determined according to DIN IEC 326 part 3 very fine.

Weidmüller PCB components are tested to the DIN EN 61984 standard, and are valid for its field of application. Provided that the components are used to the intended purpose, all requirements with respect to the occurring of electrical, mechanical, thermic and corrosive stress will be satisfied.

P=5.08 RASTER PITCH

	METRIC TOLERANCES X. = ±0.3 X.X = ±0.1 X.XX = ±0.05	70327/5 22.05.13 HELIS_MA 01	CAT.NO.:	
	MODIFICATION			
SCALE: 2/1 SUPERSEDES:	DRAWN: 27.08.2003 RESPONSIBLE: HEKTEL_S CHECKED: 27.05.2013 APPROVED: HECKERT_M	DATE: 27.08.2003 NAME: #AttributeError: Benutzer None nicht gegeben	C 21277 18 DRAWING NO. SHEET 01 OF 01 SHEETS ISSUE NO.	
SLS 5.08/.. /180... STIFTSTECKER MALE PLUG			PRODUCT FILE: SLS 5.08 7314	

WEIDMUELLER INTERFACE GmbH & Co.KG
 WEITERGABE SOWIE VERVIELFAELTIGUNG DIESER DOKUMENTS, VERWERTUNG UND MITTEILUNG SEINES INHALTS SIND VERBOTEN, SOWEIT NICHT AUSDRUECKLICH GESTATET.
 ZUWAERHANDLUNGEN VERPFLICHTEN ZU SCHADENERSATZ. ALLE RECHTE FUER DEN FALL DER PATENT-, GEBRAUCHSMUSTER-, ODER GESCHMACKSMUSTERREINTRAGUNG VORBEHALTEN.
 THE REPRODUCTION, DISTRIBUTION AND UTILIZATION OF THIS DOCUMENT AS WELL AS THE COMMUNICATION OF ITS CONTENTS TO OTHERS WITHOUT EXPLICIT AUTHORIZATION IS PROHIBITED.
 OFFENDERS WILL BE HELD LIABLE FOR THE PAYMENT OF DAMAGES. WEIDMUELLER EXCLUSIVELY RESERVES THE RIGHT TO FILE FOR PATENTS, UTILITY MODELS OR DESIGNS.