

## OMNIMATE Signal - series BL/SL 5.08 SLS 5.08/06/180B SN OR BX

**Weidmüller Interface GmbH & Co. KG**  
Klingenbergstraße 26  
D-32758 Detmold  
Germany  
Fon: +49 5231 14-0  
Fax: +49 5231 14-292083  
www.weidmueller.com

### Product image

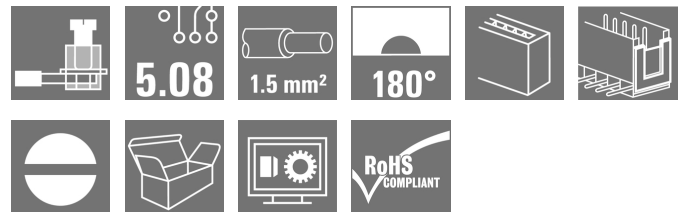

Similar to illustration

Male plugs with clamping-yoke screw wire-connect system. The male plugs provide space for labelling and can be coded.

### General ordering data

Type	SLS 5.08/06/180B SN OR BX
Order No.	<a href="#">1627280000</a>
Version	PCB plug-in connector, male plug, 5.08 mm, Number of poles: 6, 180°, Clamping yoke connection, Clamping range, max. : 3.31 mm², Box
GTIN (EAN)	4008 190199791
Qty.	54 pc(s).
Product data	IEC: 400 V / 21.5 A / 0.2 - 2.5 mm² UL: 300 V / 14 A / AWG 26 - AWG 12
Packaging	Box

Creation date May 3, 2020 8:20:50 PM CEST

**OMNIMATE Signal - series BL/SL 5.08  
SLS 5.08/06/180B SN OR BX**

**Weidmüller Interface GmbH & Co. KG**  
Klingenbergstraße 26  
D-32758 Detmold  
Germany  
Fon: +49 5231 14-0  
Fax: +49 5231 14-292083  
www.weidmueller.com

**Technical data****Dimensions and weights**

Height	15.2 mm	Height (inches)	0.598 inch
Depth	22.3 mm	Depth (inches)	0.878 inch
Net weight	8.93 g		

**System Parameters**

Product family	OMNIMATE Signal - series BL/SL 5.08	Type of connection	Field connection
Wire connection method	Clamping yoke connection	Pitch in mm (P)	5.08 mm
Pitch in inches (P)	0.2 inch	Conductor outlet direction	180°
Number of poles	6	L1 in mm	25.4 mm
L1 in inches	1 inch	Number of rows	1
Pin series quantity	1	Touch-safe protection acc. to DIN VDE 57 106	finger-safe plugged/ back-of-hand-safe unplugged
Volume resistance	≤ 5mΩ	Can be coded	Yes
Stripping length	7 mm	Tightening torque, min.	0.4 Nm
Tightening torque, max.	0.5 Nm	Clamping screw	M 2.5
Screwdriver blade	0.6 x 3.5	Screwdriver blade standard	DIN 5264-A
Plugging cycles	25	Plugging force/pole, max.	4 N
Pulling force/pole, max.	3 N		

**Material data**

Insulating material	PBT	Colour	orange
Colour chart (similar)	RAL 2000	Insulating material group	IIIa
Comparative Tracking Index (CTI)	≥ 200	Insulation strength	≥ 10 <sup>8</sup> Ω
UL 94 flammability rating	V-0	GWFI	960 °C
Contact material	CuSn	Contact surface	tinned
Layer structure of plug contact	4-8 μm Sn hot-dip tinned	Storage temperature, min.	-25 °C
Storage temperature, max.	50 °C	Max. relative humidity during storage	70 %
Operating temperature, min.	-50 °C	Operating temperature, max.	100 °C
Temperature range, installation, min.	-25 °C	Temperature range, installation, max.	100 °C

**Conductors suitable for connection**

Clamping range, min.	0.13 mm <sup>2</sup>
Clamping range, max.	3.31 mm <sup>2</sup>
Wire connection cross section AWG, min.	AWG 26
Wire connection cross section AWG, max.	AWG 12
Solid, min. H05(07) V-U	0.2 mm <sup>2</sup>
Solid, max. H05(07) V-U	2.5 mm <sup>2</sup>
Flexible, min. H05(07) V-K	0.2 mm <sup>2</sup>
Flexible, max. H05(07) V-K	2.5 mm <sup>2</sup>
w. plastic collar ferrule, DIN 46228 pt 4, 0.2 mm <sup>2</sup> min.	
w. plastic collar ferrule, DIN 46228 pt 4, 2.5 mm <sup>2</sup> max.	
w. wire end ferrule, DIN 46228 pt 1, min.	0.2 mm <sup>2</sup>
w. wire end ferrule, DIN 46228 pt 1, max.	2.5 mm <sup>2</sup>
Plug gauge in accordance with EN 60999 a x b; ø	2.8 mm x 2.0 mm; 2.4 mm

Creation date May 3, 2020 8:20:50 PM CEST

**OMNIMATE Signal - series BL/SL 5.08  
SLS 5.08/06/180B SN OR BX**

**Weidmüller Interface GmbH & Co. KG**  
Klingenbergstraße 26  
D-32758 Detmold  
Germany  
Fon: +49 5231 14-0  
Fax: +49 5231 14-292083  
www.weidmueller.com

**Technical data**

Clampable conductor	Cross-section for conductor connection	Type	fine-wired
		nominal	0.5 mm <sup>2</sup>
wire end ferrule		Stripping length	nominal 6 mm
		Recommended wire-end ferrule	<a href="#">H0.5/6</a>
Clampable conductor	Cross-section for conductor connection	Type	fine-wired
		nominal	1 mm <sup>2</sup>
wire end ferrule		Stripping length	nominal 6 mm
		Recommended wire-end ferrule	<a href="#">H1.0/6</a>
Clampable conductor	Cross-section for conductor connection	Type	fine-wired
		nominal	1.5 mm <sup>2</sup>
wire end ferrule		Stripping length	nominal 7 mm
		Recommended wire-end ferrule	<a href="#">H1.5/7</a>
Clampable conductor	Cross-section for conductor connection	Type	fine-wired
		nominal	2.5 mm <sup>2</sup>
wire end ferrule		Stripping length	nominal 7 mm
		Recommended wire-end ferrule	<a href="#">H2.5/7</a>
Clampable conductor	Cross-section for conductor connection	Type	fine-wired
		nominal	0.75 mm <sup>2</sup>
wire end ferrule		Stripping length	nominal 6 mm
		Recommended wire-end ferrule	<a href="#">H0.75/6</a>
Reference text	The outside diameter of the plastic collar should not be larger than the pitch (P). Length of ferrules is to be chosen depending on the product and the rated voltage.		
Max. clamping range	3.31 mm <sup>2</sup>		

**Rated data acc. to IEC**

tested acc. to standard	IEC 60664-1, IEC 61984	Rated current, min. number of poles (Tu=20°C)	21.5 A
Rated current, max. number of poles (Tu=20°C)	16 A	Rated current, min. number of poles (Tu=40°C)	18 A
Rated current, max. number of poles (Tu=40°C)	14 A	Rated voltage for surge voltage class / pollution degree II/2	400 V
Rated voltage for surge voltage class / pollution degree III/2	320 V	Rated voltage for surge voltage class / pollution degree III/3	250 V
Rated impulse voltage for surge voltage class/ pollution degree II/2	4 kV	Rated impulse voltage for surge voltage class/ pollution degree III/2	4 kV
Rated impulse voltage for surge voltage class/ contamination degree III/3	4 kV	Short-time withstand current resistance	3 x 1s with 120 A

**Rated data acc. to CSA**

Institute (CSA)		Certificate No. (CSA)	200039-1121690
Rated voltage (Use group B / CSA)	300 V	Rated voltage (Use group D / CSA)	300 V
Rated current (Use group B / CSA)	15 A	Rated current (Use group D / CSA)	10 A
Wire cross-section, AWG, min.	AWG 26	Wire cross-section, AWG, max.	AWG 12
Reference to approval values	Specifications are maximum values, details - see approval certificate.		

**Data sheet**

**OMNIMATE Signal - series BL/SL 5.08  
SLS 5.08/06/180B SN OR BX**

**Weidmüller Interface GmbH & Co. KG**  
Klingenbergstraße 26  
D-32758 Detmold  
Germany  
Fon: +49 5231 14-0  
Fax: +49 5231 14-292083  
www.weidmueller.com

**Technical data**

**Rated data acc. to UL 1059**

Institute (UR)		Certificate No. (UR)	E60693
Rated voltage (Use group B / UL 1059)	300 V	Rated voltage (Use group D / UL 1059)	300 V
Rated current (Use group B / UL 1059)	14 A	Rated current (Use group D / UL 1059)	10 A
Wire cross-section, AWG, min.	AWG 26	Wire cross-section, AWG, max.	AWG 12
Reference to approval values	Specifications are maximum values, details - see approval certificate.		

**Packing**

Packaging	Box	VPE length	30 mm
VPE width	135 mm	VPE height	350 mm

**Classifications**

ETIM 6.0	EC002638	ETIM 7.0	EC002638
eClass 9.0	27-44-03-09	eClass 9.1	27-44-03-09
eClass 10.0	27-44-03-09	UNSPSC	30-21-18-10

**Notes**

Notes	<ul style="list-style-type: none"> <li>• Additional colours on request</li> <li>• Rated current related to rated cross-section &amp; min. No. of poles.</li> <li>• Wire end ferrule without plastic collar to DIN 46228/1</li> <li>• Wire end ferrule with plastic collar to DIN 46228/4</li> <li>• P on drawing = pitch</li> <li>• Rated data refer only to the component itself. Clearance and creepage distances to other components are to be designed in accordance with the relevant application standards.</li> </ul>
-------	--

IPC conformity	Conformity: The products are developed, manufactured and delivered according international recognized standards and norms and comply with the assured properties in the data sheet resp. fulfill decorative properties in accordance with IPC-A-610 "Class 2". Further claims on the products can be evaluated on request.
----------------	--

**Approvals**

Approvals	
ROHS	Conform

**Data sheet****OMNIMATE Signal - series BL/SL 5.08  
SLS 5.08/06/180B SN OR BX**

**Weidmüller Interface GmbH & Co. KG**  
Klingenbergstraße 26  
D-32758 Detmold  
Germany  
Fon: +49 5231 14-0  
Fax: +49 5231 14-292083  
www.weidmueller.com

**Technical data****Downloads**

Approval/Certificate/Document of Conformity	<a href="#">Declaration of the Manufacturer</a>
Brochure/Catalogue	<a href="#">FL DRIVES EN</a> <a href="#">MB DEVICE MANUF. EN</a> <a href="#">FL DRIVES DE</a> <a href="#">CAT 2 PORTFOLIOGUIDE EN</a> <a href="#">FL BUILDING SAFETY EN</a> <a href="#">FL APPL LED LIGHTING EN</a> <a href="#">FL INDUSTR.CONTROLS EN</a> <a href="#">FL MACHINE SAFETY EN</a> <a href="#">FL HEATING ELECTR EN</a> <a href="#">FL APPL INVERTER EN</a> <a href="#">FL BASE STATION EN</a> <a href="#">FL ELEVATOR EN</a> <a href="#">FL POWER SUPPLY EN</a> <a href="#">FL 72H SAMPLE SER EN</a> <a href="#">PO OMNIMATE EN</a>
Engineering Data	<a href="#">WSCAD</a>
Engineering Data	<a href="#">STEP</a>

**Data sheet**

**OMNIMATE Signal - series BL/SL 5.08  
SLS 5.08/06/180B SN OR BX**

**Weidmüller Interface GmbH & Co. KG**  
Klingenbergstraße 26  
D-32758 Detmold  
Germany  
Fon: +49 5231 14-0  
Fax: +49 5231 14-292083  
www.weidmueller.com

**Drawings**

**Dimensional drawing**

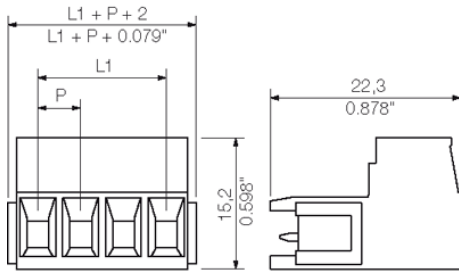

**Graph**

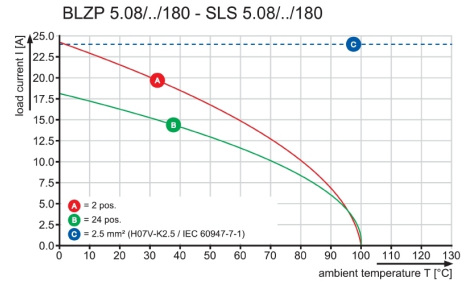

**Graph**

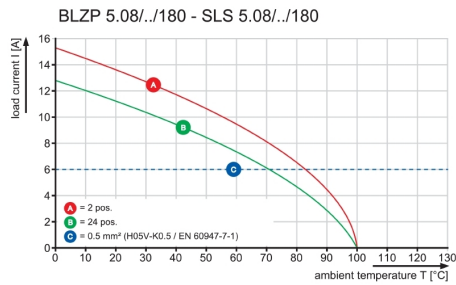

**Graph**

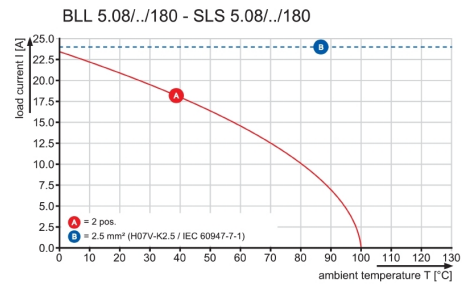

**Product benefits**

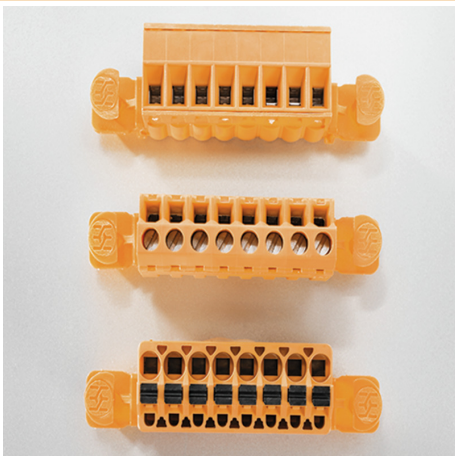

Flexible application options  
For 3 connection systems

**OMNIMATE Signal - series BL/SL 5.08  
SLS 5.08/06/180B SN OR BX**

**Weidmüller Interface GmbH & Co. KG**  
Klingenbergstraße 26  
D-32758 Detmold  
Germany  
Fon: +49 5231 14-0  
Fax: +49 5231 14-292083  
www.weidmueller.com

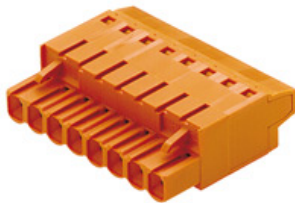
**Mating connector (conditionally pluggable)**
**BLT 5.08HC**

Female plugs with TOP screw connection system for connecting wires with straight 180° outlet direction. The female connectors provide space for labelling and can be coded. HC = High Current.

**General ordering data**

Type	BLT 5.08HC/06/180 SN BL ...	Version	Product data	Packaging
Order No.	<a href="#">1499980000</a>	PCB plug-in connector, female plug, 5.08 mm, Number of poles: 6,	IEC: 400 V / 27 A / 0.2 - 2.5 mm <sup>2</sup>	Box
GTIN (EAN)	4008190104085	180°, TOP connection, Clamping range, max. : 2.5 mm <sup>2</sup> , Box	UL: 300 V / 17 A / AWG 26 - AWG 14	
Qty.	60 pc(s).			

**BLZ 5.08/180**

Female plugs with clamping-yoke screw for wire connection with straight (180°) outlet direction. The female plugs provide space for labelling and can be coded.

**General ordering data**

Type	BLZ 5.08/06/180 SN DKGN ...	Version	Product data	Packaging
Order No.	<a href="#">1526850000</a>	PCB plug-in connector, female plug, 5.08 mm, Number of poles: 6,	IEC: 400 V / 19 A / 0.2 - 2.5 mm <sup>2</sup>	Box
GTIN (EAN)	4008190155599	180°, Clamping yoke connection, Clamping range, max. : 3.31 mm <sup>2</sup> ,	UL: 300 V / 15 A / AWG 26 - AWG 12	
Qty.	50 pc(s).	Box		
Type	BLZ 5.08/06/180 SN OR B ...	Version	Product data	Packaging
Order No.	<a href="#">1594270000</a>	PCB plug-in connector, female plug, 5.08 mm, Number of poles: 6,	IEC: 400 V / 19 A / 0.2 - 2.5 mm <sup>2</sup>	Box
GTIN (EAN)	4008190109394	180°, Clamping yoke connection, Clamping range, max. : 3.31 mm <sup>2</sup> ,	UL: 300 V / 15 A / AWG 26 - AWG 12	
Qty.	60 pc(s).	Box		
Type	BLZ 5.08/06/180 SN GY BX	Version	Product data	Packaging
Order No.	<a href="#">1526800000</a>	PCB plug-in connector, female plug, 5.08 mm, Number of poles: 6,	IEC: 400 V / 19 A / 0.2 - 2.5 mm <sup>2</sup>	Box
GTIN (EAN)	4008190287023	180°, Clamping yoke connection, Clamping range, max. : 3.31 mm <sup>2</sup> ,	UL: 300 V / 15 A / AWG 26 - AWG 12	
Qty.	50 pc(s).	Box		

**OMNIMATE Signal - series BL/SL 5.08  
SLS 5.08/06/180B SN OR BX**

**Weidmüller Interface GmbH & Co. KG**  
Klingenbergstraße 26  
D-32758 Detmold  
Germany  
Fon: +49 5231 14-0  
Fax: +49 5231 14-292083  
www.weidmueller.com

**Mating connector (conditionally pluggable)**

**BLL 5.08/180**



Female header for PCB mounting. The solder pin length is optimised for wave flow soldering.

**General ordering data**

Type	BLL 5.08/06/180 4.5 SN ...	Version	Product data	Packaging
Order No.	<a href="#">1646290000</a>	PCB plug-in connector, female header, closed side, THT solder	IEC: 400 V / 23 A	Box
GTIN (EAN)	4008190285630	connection, 5.08 mm, Number of poles: 6, 180°, Solder pin length (l):	UL: 300 V / 15 A	
Qty.	60 pc(s).	4.5 mm, tinned, black, Box		
Type	BLL 5.08/06/180 4.5 SN ...	Version	Product data	Packaging
Order No.	<a href="#">1646180000</a>	PCB plug-in connector, female header, closed side, THT solder	IEC: 400 V / 23 A	Box
GTIN (EAN)	4008190285524	connection, 5.08 mm, Number of poles: 6, 180°, Solder pin length (l):	UL: 300 V / 15 A	
Qty.	60 pc(s).	4.5 mm, tinned, orange, Box		

**BLL 5.08/90**



Female header for PCB mounting. The solder pin length is optimised for wave flow soldering.

**General ordering data**

Type	BLL 5.08/06/90 4.5 SN O ...	Version	Product data	Packaging
Order No.	<a href="#">1645960000</a>	PCB plug-in connector, female header, closed side, THT solder	IEC: 400 V / 23 A	Box
GTIN (EAN)	4008190285302	connection, 5.08 mm, Number of poles: 6, 90°, Solder pin length (l):	UL: 300 V / 15 A	
Qty.	60 pc(s).	4.5 mm, tinned, orange, Box		



**OMNIMATE Signal - series BL/SL 5.08  
SLS 5.08/06/180B SN OR BX**

**Weidmüller Interface GmbH & Co. KG**  
Klingenbergstraße 26  
D-32758 Detmold  
Germany  
Fon: +49 5231 14-0  
Fax: +49 5231 14-292083  
www.weidmueller.com

**Mating connector (fully pluggable)**
**BLZP 5.08HC/225 SN**

Clamping-yoke connection with right-angled (90° or 270°) or angled (225°) outlet direction. The female connectors provide space for labelling and can be coded. Fastened by means of a flange or release latch. They also provide an integrated plus/minus screw, protection against faulty insertion of the wire, and they are delivered with open clamping yokes. HC = High Current.

**General ordering data**

Type	BLZP 5.08HC/06/225 SN O ...	Version	Product data	Packaging
Order No.	<a href="#">1946290000</a>	PCB plug-in connector, female plug, 5.08 mm, Number of poles: 6,	IEC: 400 V / 17.5 A / 0.2 - 4 mm <sup>2</sup>	Box
GTIN (EAN)	4032248621866	225°, Clamping yoke connection, Clamping range, max. : 4 mm <sup>2</sup> , Box	UL: 300 V / 15 A / AWG 26 - AWG 12	
Qty.	60 pc(s).			
Type	BLZP 5.08HC/06/225 SN B ...	Version	Product data	Packaging
Order No.	<a href="#">1946600000</a>	PCB plug-in connector, female plug, 5.08 mm, Number of poles: 6,	IEC: 400 V / 17.5 A / 0.2 - 4 mm <sup>2</sup>	Box
GTIN (EAN)	4032248622375	225°, Clamping yoke connection, Clamping range, max. : 4 mm <sup>2</sup> , Box	UL: 300 V / 15 A / AWG 26 - AWG 12	
Qty.	60 pc(s).			

**BLZP 5.08HC/270 SN**

Female plugs with clamping-yoke connection for connecting wires with a right-angle (90° or 270°) outlet direction. The female connectors provide space for labelling and can be coded. Fastened by means of a flange or release latch. They also provide an integrated plus/minus screw, protection against faulty insertion of the wire, and they are delivered with open clamping yokes. HC = High Current.

**General ordering data**

Type	BLZP 5.08HC/06/270 SN B ...	Version	Product data	Packaging
Order No.	<a href="#">1949060000</a>	PCB plug-in connector, female plug, 5.08 mm, Number of poles: 6,	IEC: 400 V / 23 A / 0.2 - 4 mm <sup>2</sup>	Box
GTIN (EAN)	4032248626519	270°, Clamping yoke connection, Clamping range, max. : 4 mm <sup>2</sup> , Box	UL: 300 V / 20 A / AWG 26 - AWG 12	
Qty.	60 pc(s).			
Type	BLZP 5.08HC/06/270 SN O ...	Version	Product data	Packaging
Order No.	<a href="#">1948830000</a>	PCB plug-in connector, female plug, 5.08 mm, Number of poles: 6,	IEC: 400 V / 23 A / 0.2 - 4 mm <sup>2</sup>	Box
GTIN (EAN)	4032248626281	270°, Clamping yoke connection, Clamping range, max. : 4 mm <sup>2</sup> , Box	UL: 300 V / 20 A / AWG 26 - AWG 12	
Qty.	60 pc(s).			

**OMNIMATE Signal - series BL/SL 5.08  
SLS 5.08/06/180B SN OR BX**

**Weidmüller Interface GmbH & Co. KG**  
Klingenbergstraße 26  
D-32758 Detmold  
Germany  
Fon: +49 5231 14-0  
Fax: +49 5231 14-292083  
www.weidmueller.com

**Mating connector (fully pluggable)**
**BLF 5.08HC/180DF SN**

Just as reliable as the millionfold proven original and featuring innovative details:  
The BLF 5.08HC PUSH IN version of the BLZP 5.08HC female connector is not only different in terms of connection system; it also has a more compact design. Weidmüller's innovative PUSH IN spring connection system stands for the future of easy and tool-free wire connection. HC = High Current.  
In terms of versatility, the BLF 5.08HC offers just as much as the version which served as a model:

- 3 tested-and-proven wire outlet directions provide the usual flexibility for application-specific design
- 4 flange variations and the patented release latch allow the locking concept to be based on the requirements of the user
- Use the BLF 5.08HC and SL 5.08HC plug combination to reach the max. rated specifications

**General ordering data**

Type	BLF 5.08HC/06/180DF SN ...	Version	Product data	Packaging
Order No.	<a href="#">1353340000</a>	PCB plug-in connector, female plug, 5.08 mm, Number of poles: 6,	IEC: 400 V / 24 A / 0.2 - 2.5 mm <sup>2</sup>	Box
GTIN (EAN)	4050118155631	180°, PUSH IN, Spring connection, Clamping range, max. : 3.31 mm <sup>2</sup> , UL: 300 V / 18.5 A / AWG 26 - AWG		
Qty.	30 pc(s).	Box	12	

**BLZP 5.08HC/180 SN**

Female plug with clamping-yoke screw system for connecting wires with straight (180°) outlet direction. The female connectors provide space for labelling and can be coded. Fastened by means of a flange or release latch. They also provide an integrated plus/minus screw, protection against faulty insertion of the wire, and they are delivered with open clamping yokes. HC = High Current.

**General ordering data**

Type	BLZP 5.08HC/06/180 SN B ...	Version	Product data	Packaging
Order No.	<a href="#">1943850000</a>	PCB plug-in connector, female plug, 5.08 mm, Number of poles: 6,	IEC: 400 V / 23 A / 0.2 - 4 mm <sup>2</sup>	Box
GTIN (EAN)	4032248617999	180°, Clamping yoke connection, Clamping range, max. : 4 mm <sup>2</sup> , Box	UL: 300 V / 20 A / AWG 26 - AWG 12	
Qty.	60 pc(s).			
Type	BLZP 5.08HC/06/180 SN O ...	Version	Product data	Packaging
Order No.	<a href="#">1943620000</a>	PCB plug-in connector, female plug, 5.08 mm, Number of poles: 6,	IEC: 400 V / 23 A / 0.2 - 4 mm <sup>2</sup>	Box
GTIN (EAN)	4032248617616	180°, Clamping yoke connection, Clamping range, max. : 4 mm <sup>2</sup> , Box	UL: 300 V / 20 A / AWG 26 - AWG 12	
Qty.	60 pc(s).			

**OMNIMATE Signal - series BL/SL 5.08  
SLS 5.08/06/180B SN OR BX**

**Weidmüller Interface GmbH & Co. KG**  
Klingenbergstraße 26  
D-32758 Detmold  
Germany  
Fon: +49 5231 14-0  
Fax: +49 5231 14-292083  
www.weidmueller.com

**Mating connector (fully pluggable)****BLF 5.08HC/180 SN**

Just as reliable as the millionfold proven original and featuring innovative details:

The BLF 5.08HC PUSH IN version of the BLZP 5.08HC female connector is not only different in terms of connection system; it also has a more compact design. Weidmüller's innovative PUSH IN spring connection system stands for the future of easy and tool-free wire connection. HC = High Current.

In terms of versatility, the BLF 5.08HC offers just as much as the version which served as a model:

- 3 tested-and-proven wire outlet directions provide the usual flexibility for application-specific design
- 4 flange variations and the patented release latch allow the locking concept to be based on the requirements of the user
- Use the BLF 5.08HC and SL 5.08HC plug combination to reach the max. rated specifications

**General ordering data**

Type	BLF 5.08HC/06/180 SN BK ...	Version	Product data	Packaging
Order No.	<a href="#">1013470000</a>	PCB plug-in connector, female plug, 5.08 mm, Number of poles: 6,	IEC: 400 V / 24 A / 0.2 - 2.5 mm <sup>2</sup>	Box
GTIN (EAN)	4032248721627	180°, PUSH IN, Tension-clamp connection, Clamping range, max. :	UL: 300 V / 18.5 A / AWG 26 - AWG	
Qty.	60 pc(s).	3.31 mm <sup>2</sup> , Box	12	
Type	BLF 5.08HC/06/180 SN OR ...	Version	Product data	Packaging
Order No.	<a href="#">1013730000</a>	PCB plug-in connector, female plug, 5.08 mm, Number of poles: 6,	IEC: 400 V / 24 A / 0.2 - 2.5 mm <sup>2</sup>	Box
GTIN (EAN)	4032248721849	180°, PUSH IN, Spring connection, Clamping range, max. : 3.31 mm <sup>2</sup> ,	UL: 300 V / 18.5 A / AWG 26 - AWG	
Qty.	60 pc(s).	Box	12	

**BLZP 5.08HC/90 SN**

Female plugs with clamping-yoke connection for connecting wires with a right-angle (90° or 270°) outlet direction. The female connectors provide space for labelling and can be coded. Fastened by means of a flange or release latch. They also provide an integrated plus/minus screw, protection against faulty insertion of the wire, and they are delivered with open clamping yokes. HC = High Current.

**General ordering data**

Type	BLZP 5.08HC/06/90 SN OR ...	Version	Product data	Packaging
Order No.	<a href="#">1948040000</a>	PCB plug-in connector, female plug, 5.08 mm, Number of poles: 6,	IEC: 400 V / 23 A / 0.2 - 4 mm <sup>2</sup>	Box
GTIN (EAN)	4032248624263	90°, Clamping yoke connection, Clamping range, max. : 4 mm <sup>2</sup> , Box	UL: 300 V / 20 A / AWG 26 - AWG 12	
Qty.	60 pc(s).			
Type	BLZP 5.08HC/06/90 SN BK ...	Version	Product data	Packaging
Order No.	<a href="#">1948280000</a>	PCB plug-in connector, female plug, 5.08 mm, Number of poles: 6,	IEC: 400 V / 23 A / 0.2 - 4 mm <sup>2</sup>	Box
GTIN (EAN)	4032248624805	90°, Clamping yoke connection, Clamping range, max. : 4 mm <sup>2</sup> , Box	UL: 300 V / 20 A / AWG 26 - AWG 12	
Qty.	60 pc(s).			

**OMNIMATE Signal - series BL/SL 5.08  
SLS 5.08/06/180B SN OR BX**

**Weidmüller Interface GmbH & Co. KG**  
Klingenbergstraße 26  
D-32758 Detmold  
Germany  
Fon: +49 5231 14-0  
Fax: +49 5231 14-292083  
www.weidmueller.com

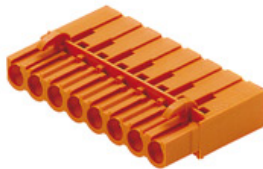
**Mating connector (fully pluggable)**
**BLC 5.08R**

Female plugs with crimp wire connection system. The female plugs provide space for labelling and can be coded.

**General ordering data**

Type	BLC 5.08/06/180R OR BX	Version	Product data	Packaging
Order No.	<a href="#">1610530000</a>	PCB plug-in connector, female plug, 5.08 mm, Number of poles: 6,	IEC: 400 V / 21 A	Box
GTIN (EAN)	4008190123819	180°, Crimp connection, Clamping range, max. : 2.5 mm <sup>2</sup> , Box	UL: 300 V / 10 A / AWG 26 - AWG 14	
Qty.	50 pc(s).			
Type	BLC 5.08/06/180R BK BX	Version	Product data	Packaging
Order No.	<a href="#">1712000000</a>	PCB plug-in connector, female plug, 5.08 mm, Number of poles: 6,	IEC: 400 V / 21 A	Box
GTIN (EAN)	4008190935016	180°, Crimp connection, Clamping range, max. : 2.5 mm <sup>2</sup> , Box	UL: 300 V / 10 A / AWG 26 - AWG 14	
Qty.	50 pc(s).			

**BLF 5.08HC/90 SN**

Just as reliable as the millionfold proven original and featuring innovative details:  
The BLF 5.08HC PUSH IN version of the BLZP 5.08HC female connector is not only different in terms of connection system; it also has a more compact design. Weidmüller's innovative PUSH IN spring connection system stands for the future of easy and tool-free wire connection. HC = High Current.  
In terms of versatility, the BLF 5.08HC offers just as much as the version which served as a model:

- 3 tested-and-proven wire outlet directions provide the usual flexibility for application-specific design
- 4 flange variations and the patented release latch allow the locking concept to be based on the requirements of the user
- Use the BLF 5.08HC and SL 5.08HC plug combination to reach the max. rated specifications

**General ordering data**

Type	BLF 5.08HC/06/90 SN BK ...	Version	Product data	Packaging
Order No.	<a href="#">1000070001</a>	PCB plug-in connector, female plug, 5.08 mm, Number of poles: 6,	IEC: 400 V / 24 A / 0.2 - 2.5 mm <sup>2</sup>	Box
GTIN (EAN)	4032248690008	90°, PUSH IN, Spring connection, Clamping range, max. : 3.31 mm <sup>2</sup> ,	UL: 300 V / 18.5 A / AWG 26 - AWG 12	
Qty.	60 pc(s).	Box		
Type	BLF 5.08HC/06/90 SN OR ...	Version	Product data	Packaging
Order No.	<a href="#">1001570000</a>	PCB plug-in connector, female plug, 5.08 mm, Number of poles: 6,	IEC: 400 V / 24 A / 0.2 - 2.5 mm <sup>2</sup>	Box
GTIN (EAN)	4032248693375	90°, PUSH IN, Spring connection, Clamping range, max. : 3.31 mm <sup>2</sup> ,	UL: 300 V / 18.5 A / AWG 26 - AWG 12	
Qty.	60 pc(s).	Box		

**OMNIMATE Signal - series BL/SL 5.08  
SLS 5.08/06/180B SN OR BX**

**Weidmüller Interface GmbH & Co. KG**  
Klingenbergstraße 26  
D-32758 Detmold  
Germany  
Fon: +49 5231 14-0  
Fax: +49 5231 14-292083  
www.weidmueller.com

**Mating connector (fully pluggable)**
**BLDT 5.08**

Female plugs with two clamping-yoke screw connections per pole for wire connections with 90° and 270° outlet directions. The female plugs provide space for labelling and can be coded.

**General ordering data**

Type	BLDT 5.08/06/- SN BK BX	Version	Product data	Packaging
Order No.	<a href="#">1660750000</a>	PCB plug-in connector, female plug, 5.08 mm, Number of poles: 6,	IEC: 400 V / 14 A / 0.2 - 2.5 mm <sup>2</sup>	Box
GTIN (EAN)	4008190417208	180°, Clamping yoke connection, Clamping range, max. : 3.31 mm <sup>2</sup> ,	UL: 300 V / 10 A / AWG 26 - AWG 12	
Qty.	50 pc(s).	Box		
Type	BLDT 5.08/06/- SN OR BX	Version	Product data	Packaging
Order No.	<a href="#">1644770000</a>	PCB plug-in connector, female plug, 5.08 mm, Number of poles: 6,	IEC: 400 V / 14 A / 0.2 - 2.5 mm <sup>2</sup>	Box
GTIN (EAN)	4008190283988	180°, Clamping yoke connection, Clamping range, max. : 3.31 mm <sup>2</sup> ,	UL: 300 V / 10 A / AWG 26 - AWG 12	
Qty.	50 pc(s).	Box		

**BLF 5.08HC/270 SN**

Just as reliable as the millionfold proven original and featuring innovative details:  
The BLF 5.08HC PUSH IN version of the BLZP 5.08HC female connector is not only different in terms of connection system; it also has a more compact design. Weidmüller's innovative PUSH IN spring connection system stands for the future of easy and tool-free wire connection. HC = High Current.  
In terms of versatility, the BLF 5.08HC offers just as much as the version which served as a model:

- 3 tested-and-proven wire outlet directions provide the usual flexibility for application-specific design
- 4 flange variations and the patented release latch allow the locking concept to be based on the requirements of the user
- Use the BLF 5.08HC and SL 5.08HC plug combination to reach the max. rated specifications

**General ordering data**

Type	BLF 5.08HC/06/270 SN BK ...	Version	Product data	Packaging
Order No.	<a href="#">1981970000</a>	PCB plug-in connector, female plug, 5.08 mm, Number of poles: 6,	IEC: 400 V / 24 A / 0.2 - 2.5 mm <sup>2</sup>	Box
GTIN (EAN)	4032248684663	270°, PUSH IN, Spring connection, Clamping range, max. : 3.31 mm <sup>2</sup> ,	UL: 300 V / 18.5 A / AWG 26 - AWG 12	
Qty.	60 pc(s).	Box		
Type	BLF 5.08HC/06/270 SN OR ...	Version	Product data	Packaging
Order No.	<a href="#">1982740000</a>	PCB plug-in connector, female plug, 5.08 mm, Number of poles: 6,	IEC: 400 V / 24 A / 0.2 - 2.5 mm <sup>2</sup>	Box
GTIN (EAN)	4032248686834	270°, PUSH IN, Spring connection, Clamping range, max. : 3.31 mm <sup>2</sup> ,	UL: 300 V / 18.5 A / AWG 26 - AWG 12	
Qty.	60 pc(s).	Box		

**OMNIMATE Signal - series BL/SL 5.08  
SLS 5.08/06/180B SN OR BX**

**Weidmüller Interface GmbH & Co. KG**  
Klingenbergstraße 26  
D-32758 Detmold  
Germany  
Fon: +49 5231 14-0  
Fax: +49 5231 14-292083  
www.weidmueller.com

**Mating connector (fully pluggable)**
**BLZP 5.08HC/225B SN**

Clamping-yoke connection with right-angled (90° or 270°) or angled (225°) outlet direction. The female connectors provide space for labelling and can be coded. Fastened by means of a flange or release latch. They also provide an integrated plus/minus screw, protection against faulty insertion of the wire, and they are delivered with open clamping yokes. HC = High Current.

**General ordering data**

Type	BLZP 5.08HC/06/225B SN ...	Version	Product data	Packaging
Order No.	<a href="#">1945790000</a>	PCB plug-in connector, female plug, 5.08 mm, Number of poles: 6,	IEC: 400 V / 17.5 A / 0.2 - 4 mm <sup>2</sup>	Box
GTIN (EAN)	4032248621262	225°, Clamping yoke connection, Clamping range, max. : 4 mm <sup>2</sup> , Box	UL: 300 V / 15 A / AWG 26 - AWG 12	
Qty.	54 pc(s).			
Type	BLZP 5.08HC/06/225B SN ...	Version	Product data	Packaging
Order No.	<a href="#">1946020000</a>	PCB plug-in connector, female plug, 5.08 mm, Number of poles: 6,	IEC: 400 V / 17.5 A / 0.2 - 4 mm <sup>2</sup>	Box
GTIN (EAN)	4032248621552	225°, Clamping yoke connection, Clamping range, max. : 4 mm <sup>2</sup> , Box	UL: 300 V / 15 A / AWG 26 - AWG 12	
Qty.	54 pc(s).			

**BLL 5.08/180**

Female header for PCB mounting. The solder pin length is optimised for wave flow soldering.

**General ordering data**

Type	BLL 5.08/06/180 3.2 SN ...	Version	Product data	Packaging
Order No.	<a href="#">1630750000</a>	PCB plug-in connector, female header, closed side, THT solder	IEC: 400 V / 23 A	Box
GTIN (EAN)	4008190204174	connection, 5.08 mm, Number of poles: 6, 180°, Solder pin length (!):	UL: 300 V / 15 A	
Qty.	60 pc(s).	3.2 mm, tinned, orange, Box		



**OMNIMATE Signal - series BL/SL 5.08  
SLS 5.08/06/180B SN OR BX**

**Weidmüller Interface GmbH & Co. KG**  
Klingenbergstraße 26  
D-32758 Detmold  
Germany  
Fon: +49 5231 14-0  
Fax: +49 5231 14-292083  
www.weidmueller.com

**Mating connector (fully pluggable)**
**BLL 5.08/90**

Female header for PCB mounting. The solder pin length is optimised for wave flow soldering.

**General ordering data**

Type	BLL 5.08/06/90 3.2 SN O ...	Version	Product data	Packaging
Order No.	<a href="#">1622980000</a>	PCB plug-in connector, female header, closed side, THT solder connection, 5.08 mm, Number of poles: 6, 90°, Solder pin length (l): 3.2 mm, tinned, orange, Box	IEC: 400 V / 23 A UL: 300 V / 15 A	Box
GTIN (EAN)	4008190279301			
Qty.	60 pc(s).			

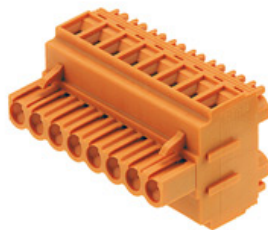
**BLDT 5.08B**

Female plugs with two clamping-yoke screw connections per pole for wire connections with 90° and 270° outlet directions. The female plugs provide space for labelling and can be coded.

**General ordering data**

Type	BLDT 5.08/06/-B SN OR BX	Version	Product data	Packaging
Order No.	<a href="#">1651780000</a>	PCB plug-in connector, female plug, 5.08 mm, Number of poles: 6, 180°, Clamping yoke connection, Clamping range, max. : 3.31 mm², Box	IEC: 400 V / 14 A / 0.2 - 2.5 mm² UL: 300 V / 10 A / AWG 26 - AWG 12	Box
GTIN (EAN)	4008190400460			
Qty.	45 pc(s).			
Type	BLDT 5.08/06/-B SN BK BX	Version	Product data	Packaging
Order No.	<a href="#">1673820000</a>	PCB plug-in connector, female plug, 5.08 mm, Number of poles: 6, 180°, Clamping yoke connection, Clamping range, max. : 3.31 mm², Box	IEC: 400 V / 14 A / 0.2 - 2.5 mm² UL: 300 V / 10 A / AWG 26 - AWG 12	Box
GTIN (EAN)	4008190435554			
Qty.	45 pc(s).			

**OMNIMATE Signal - series BL/SL 5.08  
SLS 5.08/06/180B SN OR BX**

**Weidmüller Interface GmbH & Co. KG**  
Klingenbergstraße 26  
D-32758 Detmold  
Germany  
Fon: +49 5231 14-0  
Fax: +49 5231 14-292083  
www.weidmueller.com

**Mating connector (fully pluggable)**
**BLDF 5.08/180 SN**

The powerful daisy-chain solution for high-performance signal bus applications is also suitable for 400V auxiliary power chains with 18.5A current-carrying capacity. The large clamping capacity (up to 2.5mm<sup>2</sup> wire cross-sections) is particularly beneficial for long bus cables or high currents because of the low voltage drop. Four flange variations, including the patented release latch, allow for user-friendly unplugging designs.

**General ordering data**

Type	BLDF 5.08/06/180 SN OR ...	Version	Product data	Packaging
Order No.	<a href="#">1001190000</a>	PCB plug-in connector, female plug, 5.08 mm, Number of poles: 6,	IEC: 400 V / 20.8 A / 0.2 - 2.5 mm <sup>2</sup>	Box
GTIN (EAN)	4032248818174	180°, PUSH IN, Spring connection, Clamping range, max.: 3.31 mm <sup>2</sup> ,	UL: 300 V / 18.5 A / AWG 12 - AWG	
Qty.	40 pc(s).	Box	26	
Type	BLDF 5.08/06/180 SN BK ...	Version	Product data	Packaging
Order No.	<a href="#">1000900000</a>	PCB plug-in connector, female plug, 5.08 mm, Number of poles: 6,	IEC: 400 V / 20.8 A / 0.2 - 2.5 mm <sup>2</sup>	Box
GTIN (EAN)	4032248817412	180°, PUSH IN, Spring connection, Clamping range, max.: 3.31 mm <sup>2</sup> ,	UL: 300 V / 18.5 A / AWG 12 - AWG	
Qty.	40 pc(s).	Box	26	

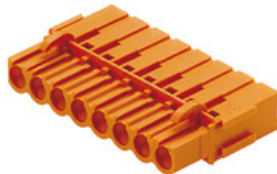
**BLC 5.08BR**

Female plugs with crimp wire connection system. The female plugs provide space for labelling and can be coded.

**General ordering data**

Type	BLC 5.08/06/180BR BK BX	Version	Product data	Packaging
Order No.	<a href="#">1712150000</a>	PCB plug-in connector, female plug, 5.08 mm, Number of poles: 6,	IEC: 400 V / 21 A	Box
GTIN (EAN)	4008190935160	180°, Crimp connection, Clamping range, max.: 2.5 mm <sup>2</sup> ,	UL: 300 V / 10 A / AWG 26 - AWG 14	
Qty.	50 pc(s).	Box		
Type	BLC 5.08/06/180BR OR BX	Version	Product data	Packaging
Order No.	<a href="#">1649410000</a>	PCB plug-in connector, female plug, 5.08 mm, Number of poles: 6,	IEC: 400 V / 21 A	Box
GTIN (EAN)	4008190294526	180°, Crimp connection, Clamping range, max.: 2.5 mm <sup>2</sup> ,	UL: 300 V / 10 A / AWG 26 - AWG 14	
Qty.	50 pc(s).			



**OMNIMATE Signal - series BL/SL 5.08  
SLS 5.08/06/180B SN OR BX**

**Weidmüller Interface GmbH & Co. KG**  
Klingenbergstraße 26  
D-32758 Detmold  
Germany  
Fon: +49 5231 14-0  
Fax: +49 5231 14-292083  
www.weidmueller.com

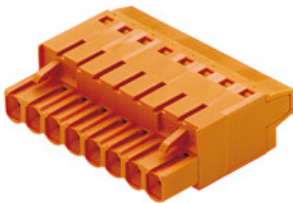
**Mating connector (fully pluggable)**
**BLT 5.08HC/180B**

Female plugs with TOP screw connection system for connecting wires with straight 180° outlet direction. The female connectors provide space for labelling and can be coded. HC = High Current.

**General ordering data**

Type	BLT 5.08HC/06/180B SN O ...	Version	Product data	Packaging
Order No.	<a href="#">1502260000</a>	PCB plug-in connector, female plug, 5.08 mm, Number of poles: 6,	IEC: 400 V / 27 A / 0.2 - 2.5 mm <sup>2</sup>	Box
GTIN (EAN)	4008190034313	180°, TOP connection, Clamping range, max. : 2.5 mm <sup>2</sup> , Box	UL: 300 V / 17 A / AWG 26 - AWG 14	
Qty.	54 pc(s).			

**BLL 5.08/180B**

Female header for PCB mounting. The solder pin length is optimised for wave flow soldering.

**General ordering data**

Type	BLL 5.08/06/180B 3.2SN ...	Version	Product data	Packaging
Order No.	<a href="#">1682770000</a>	PCB plug-in connector, female header, Dovetails for fixing blocks, THT	IEC: 400 V / 23 A	Box
GTIN (EAN)	4008190474539	solder connection, 5.08 mm, Number of poles: 6, 180°, Solder pin	UL: 300 V / 15 A	
Qty.	54 pc(s).	length (l): 3.2 mm, tinned, orange, Box		

## OMNIMATE Signal - series BL/SL 5.08 SLS 5.08/06/180B SN OR BX

**Weidmüller Interface GmbH & Co. KG**  
 Klingenbergstraße 26  
 D-32758 Detmold  
 Germany  
 Fon: +49 5231 14-0  
 Fax: +49 5231 14-292083  
 www.weidmueller.com

# Accessories

### Coding elements



**Only connects what is supposed to be connected:  
the right connection at the right place.**

Coding elements and locking devices clearly assign connecting elements during the manufacturing process and operation

The coding elements and locking devices are inserted prior to assembly or during the cable assembly phase. The Weidmüller alternative: configure online using the variant configurator to precode prior to delivery. Incorrect assembly on the circuit board and incorrect plugging of connecting elements is no longer possible. The advantage: no troubleshooting during manufacture and no operational errors by the user.

### General ordering data

Type	BLZ/SL KO BK BX	Version	Product data	Packaging
Order No.	<a href="#">1545710000</a>	PCB plug-in connector, Accessories, Coding element, black, Number		Box
GTIN (EAN)	4008190087142	of poles: 1		
Qty.	50 pc(s).			
Type	BLZ/SL KO OR BX	Version	Product data	Packaging
Order No.	<a href="#">1573010000</a>	PCB plug-in connector, Accessories, Coding element, orange, Number		Box
GTIN (EAN)	4008190048396	of poles: 1		
Qty.	100 pc(s).			

### Blocks for PCB mounting



**Minor component, major effect:**

Clip-on attachment elements increase the mechanical resilience of the whole plug connection by

- securing the male connectors to the circuit board
- providing a vibration-proof connection between the sockets and the male connectors

Clip-on or pre-assembled - always the right solution:

- Hard-wearing, precise fitting dovetail joint
- Hard-wearing metal threaded inserts
- Suitable for all outlet directions

Maximum stability, minimum effort:

- Extremely resilient for frequent fastening operations
- Complete set for easy selection

The result: soldering points, contacts and overall module are more resilient against mechanical stress such as vibrations and tensile loads.

### General ordering data

Type	SLA BB6R OR	Version	Product data	Packaging
Order No.	<a href="#">1723470000</a>	PCB plug-in connector, Accessories, Mounting block, orange, Number		Box
GTIN (EAN)	4008190366025	of poles: 1		
Qty.	20 pc(s).			

**OMNIMATE Signal - series BL/SL 5.08  
SLS 5.08/06/180B SN OR BX**

**Weidmüller Interface GmbH & Co. KG**  
Klingenbergstraße 26  
D-32758 Detmold  
Germany  
Fon: +49 5231 14-0  
Fax: +49 5231 14-292083  
www.weidmueller.com

**Accessories**

Type	SLA BB6R SW	Version	Product data	Packaging
Order No.	<a href="#">1723520000</a>	PCB plug-in connector, Accessories, Mounting block, black, Number of		Box
GTIN (EAN)	4008190366070	poles: 1		
Qty.	20 pc(s).			
Type	SLA BB5R OR	Version	Product data	Packaging
Order No.	<a href="#">1723460000</a>	PCB plug-in connector, Accessories, Mounting block, orange, Number		Box
GTIN (EAN)	4008190366018	of poles: 1		
Qty.	20 pc(s).			
Type	SLA BB11R SW	Version	Product data	Packaging
Order No.	<a href="#">1692340000</a>	PCB plug-in connector, Accessories, Mounting block, black, Number of		Box
GTIN (EAN)	4008190864965	poles: 1		
Qty.	20 pc(s).			
Type	SLA BB11R OR	Version	Product data	Packaging
Order No.	<a href="#">1604120000</a>	PCB plug-in connector, Accessories, Mounting block, orange, Number		Box
GTIN (EAN)	4008190182977	of poles: 1		
Qty.	20 pc(s).			
Type	SLA BB1R OR	Version	Product data	Packaging
Order No.	<a href="#">1723430000</a>	PCB plug-in connector, Accessories, Mounting block, orange, Number		Box
GTIN (EAN)	4008190365981	of poles: 1		
Qty.	20 pc(s).			
Type	SLA BB1R SW	Version	Product data	Packaging
Order No.	<a href="#">1723480000</a>	PCB plug-in connector, Accessories, Mounting block, black, Number of		Box
GTIN (EAN)	4008190366032	poles: 1		
Qty.	20 pc(s).			
Type	SLA BB5R SW	Version	Product data	Packaging
Order No.	<a href="#">1723510000</a>	PCB plug-in connector, Accessories, Mounting block, black, Number of		Box
GTIN (EAN)	4008190366063	poles: 1		
Qty.	20 pc(s).			
Type	SLA BB2R OR	Version	Product data	Packaging
Order No.	<a href="#">1723440000</a>	PCB plug-in connector, Accessories, Mounting block, orange, Number		Box
GTIN (EAN)	4008190365998	of poles: 1		
Qty.	20 pc(s).			
Type	SLA BB12R SW	Version	Product data	Packaging
Order No.	<a href="#">1626880000</a>	PCB plug-in connector, Accessories, Mounting block, black, Number of		Box
GTIN (EAN)	4008190198213	poles: 1		
Qty.	100 pc(s).			
Type	SLA BB2R SW	Version	Product data	Packaging
Order No.	<a href="#">1723490000</a>	PCB plug-in connector, Accessories, Mounting block, black, Number of		Box
GTIN (EAN)	4008190366049	poles: 1		
Qty.	20 pc(s).			
Type	SLA BB12R OR	Version	Product data	Packaging
Order No.	<a href="#">1593450000</a>	PCB plug-in connector, Accessories, Mounting block, orange, Number		Box
GTIN (EAN)	4008190122164	of poles: 1		
Qty.	100 pc(s).			

MASSE OHNE TOLERANZ SIND KEINE PRUEFMASSE  
 DIMS. WITHOUT TOLERANCE ARE NOT CONTROL DIMS.

ALLGEMEINGUELTIGE KUNDENZEICHNUNG, AKTUELLER STAND NUR AUF ANFRAGE  
 GENERAL CUSTOMER DRAWING, TOPICAL VERSION ONLY IF REQUIRED

DIE DEUTSCHE VERSION IST VERBINDLICH  
 THE GERMAN VERSION IS BINDING

SHOWN: SLS 5.08/04/180

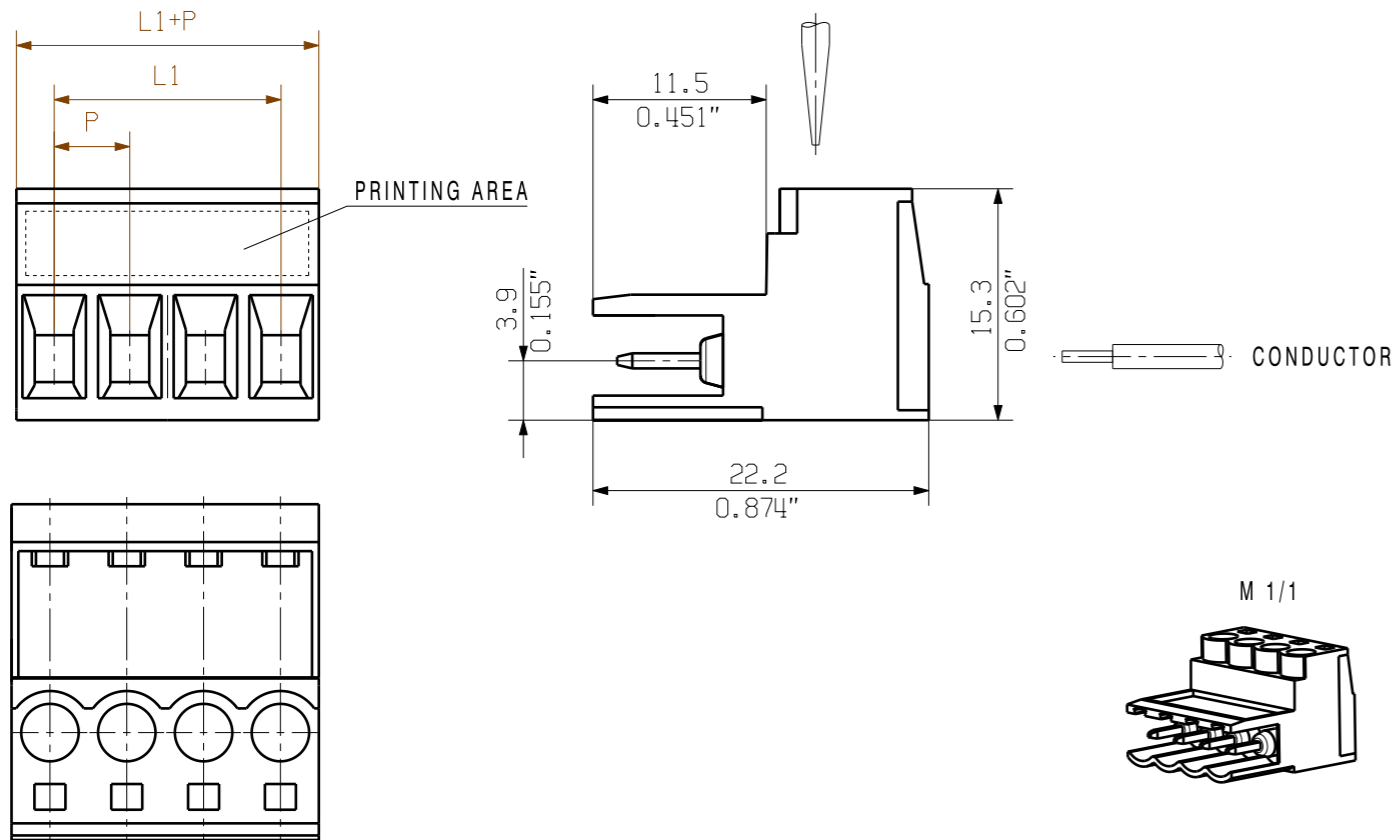

SHOWN: SLS 5.08/04/180DF

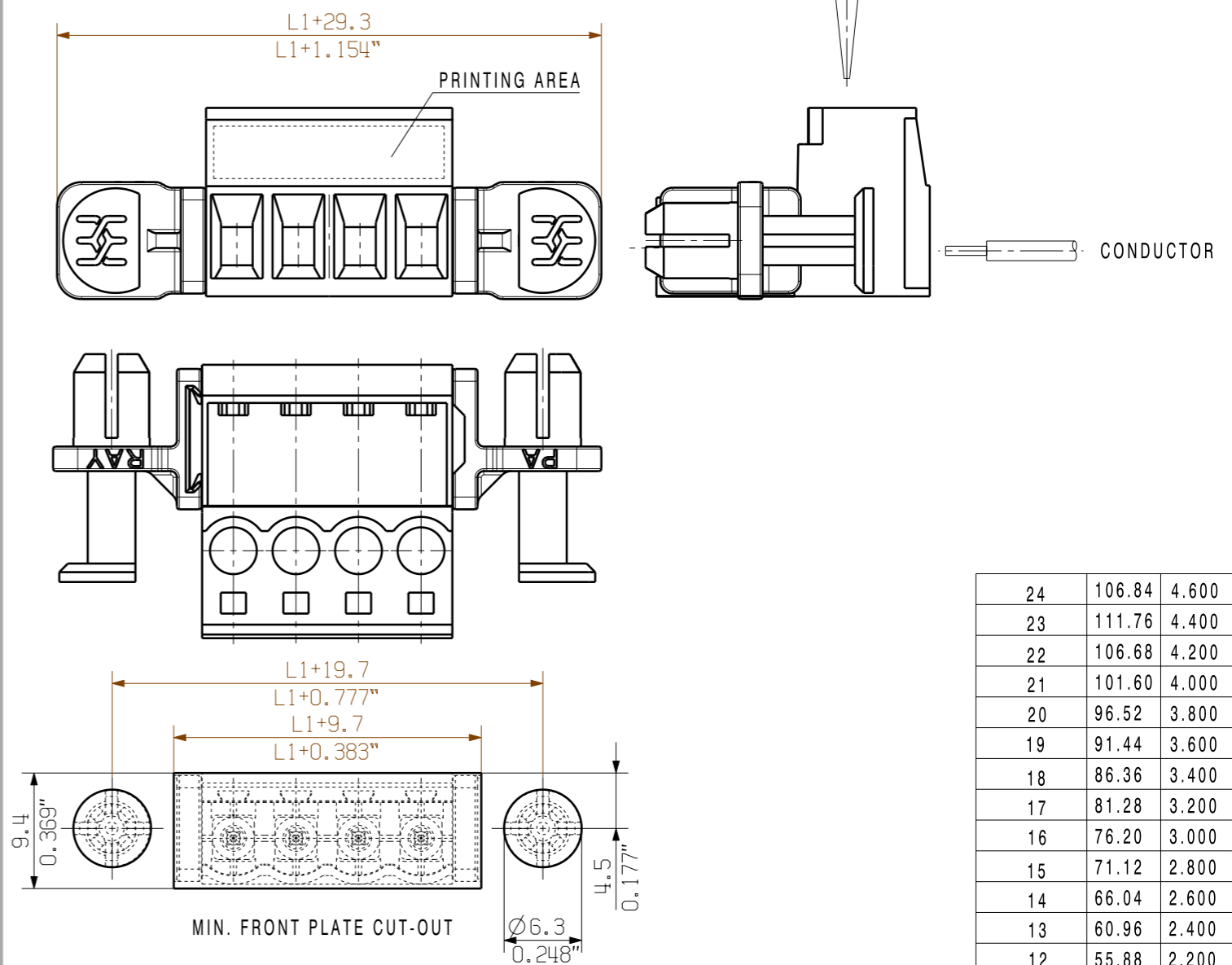

SHOWN: SLS 5.08/04/180B

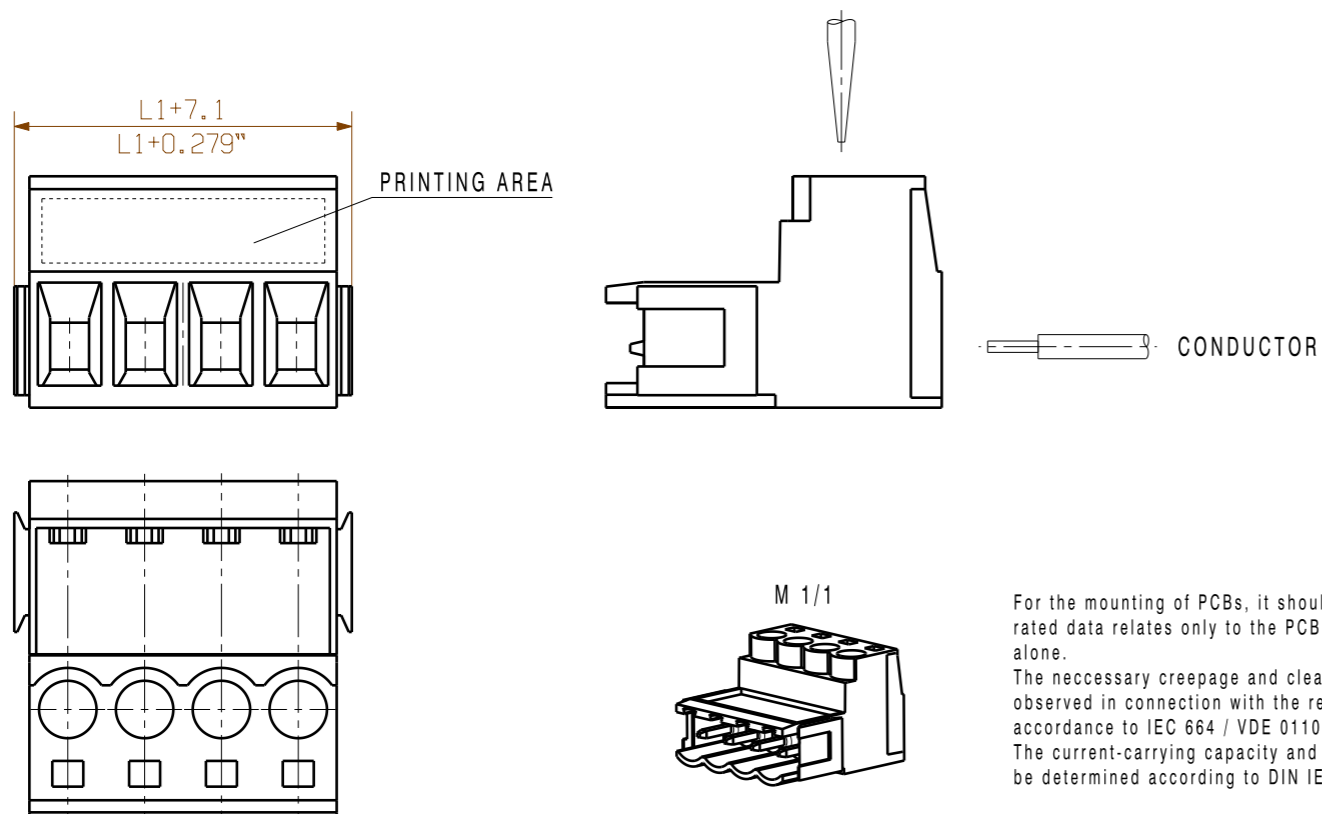

0.5-0.8	0.019-0.031	6.3	0.248
1.00	0.039	6.4	0.252
1.5	0.059	6.5	0.256
2.00	0.079	6.7	0.264
WANDDICKE WALL THICKNESS [mm]	WANDDICKE WALL THICKNESS [inch]	d [mm]	d [inch]

24	106.84	4.600
23	111.76	4.400
22	106.68	4.200
21	101.60	4.000
20	96.52	3.800
19	91.44	3.600
18	86.36	3.400
17	81.28	3.200
16	76.20	3.000
15	71.12	2.800
14	66.04	2.600
13	60.96	2.400
12	55.88	2.200
11	50.80	2.000
10	45.72	1.800
9	40.64	1.600
8	35.56	1.400
7	30.48	1.200
6	25.40	1.000
5	20.32	0.800
4	15.24	0.600
3	10.16	0.400
2	5.08	0.200
n POLES	L1 [mm]	L1 [inch]

For the mounting of PCBs, it should be noted that the rated data relates only to the PCB components alone.  
 The necessary creepage and clearance paths must be observed in connection with the respective applicant in accordance to IEC 664 / VDE 0110.  
 The current-carrying capacity and pitch tolerance is to be determined according to DIN IEC 326 part 3 very fine.

Weidmüller PCB components are tested to the DIN EN 61984 standard, and are valid for its field of application. Provided that the components are used to the intended purpose, all requirements with respect to the occurring of electrical, mechanical, thermic and corrosive stress will be satisfied.

P=5.08 RASTER PITCH

	METRIC TOLERANCES	70327/5 22.05.13 HELIS_MA 01		CAT.NO.: .	
	X. = ±0.3 X.X = ±0.1 X.XX = ±0.05	MODIFICATION			
	DRAWN	DATE	NAME	DRAWING NO. C 21277 18	
	RESPONSIBLE	27.08.2003	#AttributeError: Benutzer None nicht gegeben	SHEET 01 OF 01 SHEETS	
	CHECKED	27.05.2013	HECKERT_M	ISSUE NO.	
SCALE: 2/1 SUPERSEDES: .	APPROVED	HECKERT_M	PRODUCT FILE: SLS 5.08		7314

WEIDMÜLLER INTERFACE GmbH & Co. KG  
 WEITERGABE SOWIE VERVIELFÄLTIGUNG DIESER DOKUMENTS, VERWERTUNG UND MITTEILUNG SEINES INHALTS SIND VERBOTEN, SOWEIT NICHT AUSDRUECKLICH GESTATET.  
 ZUWIDERHANDLUNGEN VERPFLICHTEN ZU SCHADENERSATZ. ALLE RECHTE FUER DEN FALL DER PATENT-, GEBRAUCHSMUSTER-, ODER GESCHMACKSMUSTERREINTRAGUNG VORBEHALTEN.  
 THE REPRODUCTION, DISTRIBUTION AND UTILIZATION OF THIS DOCUMENT AS WELL AS THE COMMUNICATION OF ITS CONTENTS TO OTHERS WITHOUT EXPLICIT AUTHORIZATION IS PROHIBITED.  
 OFFENDERS WILL BE HELD LIABLE FOR THE PAYMENT OF DAMAGES. WEIDMÜLLER EXCLUSIVELY RESERVES THE RIGHT TO FILE FOR PATENTS, UTILITY MODELS OR DESIGNS.