

OMNIMATE Signal - series BL/SL 5.08 SLS 5.08/08/180 SN OR BX

Weidmüller Interface GmbH & Co. KG
Klingenbergstraße 26
D-32758 Detmold
Germany
Fon: +49 5231 14-0
Fax: +49 5231 14-292083
www.weidmueller.com

Product image

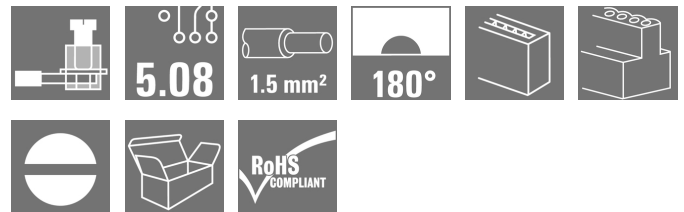

Male plugs with clamping-yoke screw wire-connect system. The male plugs provide space for labelling and can be coded.

General ordering data

Type	SLS 5.08/08/180 SN OR BX
Order No.	1627150000
Version	PCB plug-in connector, male plug, 5.08 mm, Number of poles: 8, 180°, Clamping yoke connection, Clamping range, max. : 3.31 mm², Box
GTIN (EAN)	4008190199661
Qty.	42 pc(s).
Product data	IEC: 400 V / 21.5 A / 0.2 - 2.5 mm² UL: 300 V / 14 A / AWG 26 - AWG 12
Packaging	Box

Creation date May 3, 2020 8:23:45 PM CEST

**OMNIMATE Signal - series BL/SL 5.08
SLS 5.08/08/180 SN OR BX**

Weidmüller Interface GmbH & Co. KG
 Klingenbergstraße 26
 D-32758 Detmold
 Germany
 Fon: +49 5231 14-0
 Fax: +49 5231 14-292083
 www.weidmueller.com

Technical data**Dimensions and weights**

Height	15.3 mm	Height (inches)	0.602 inch
Depth	22.2 mm	Depth (inches)	0.874 inch
Net weight	12.03 g		

System Parameters

Product family	OMNIMATE Signal - series BL/SL 5.08	Type of connection	Field connection
Wire connection method	Clamping yoke connection	Pitch in mm (P)	5.08 mm
Pitch in inches (P)	0.2 inch	Conductor outlet direction	180°
Number of poles	8	L1 in mm	35.56 mm
L1 in inches	1.4 inch	Number of rows	1
Pin series quantity	1	Touch-safe protection acc. to DIN VDE 57 106	finger-safe plugged/ back-of-hand-safe unplugged
Volume resistance	≤ 5mΩ	Can be coded	Yes
Stripping length	7 mm	Tightening torque, min.	0.4 Nm
Tightening torque, max.	0.5 Nm	Clamping screw	M 2.5
Screwdriver blade	0.6 x 3.5	Screwdriver blade standard	DIN 5264-A
Plugging cycles	25	Plugging force/pole, max.	4 N
Pulling force/pole, max.	3 N		

Material data

Colour	orange	Colour chart (similar)	RAL 2000
Insulating material group	IIIa	Comparative Tracking Index (CTI)	≥ 200
Insulation strength	≥ 10 ⁸ Ω	GWFI	960 °C
Contact material	CuSn	Contact surface	tinned
Layer structure of plug contact	4-8 μm Sn hot-dip tinned	Storage temperature, min.	-25 °C
Storage temperature, max.	50 °C	Max. relative humidity during storage	70 %
Operating temperature, min.	-50 °C	Operating temperature, max.	100 °C
Temperature range, installation, min.	-25 °C	Temperature range, installation, max.	100 °C

Conductors suitable for connection

Clamping range, min.	0.13 mm ²
Clamping range, max.	3.31 mm ²
Wire connection cross section AWG, min.	AWG 26
Wire connection cross section AWG, max.	AWG 12
Solid, min. H05(07) V-U	0.2 mm ²
Solid, max. H05(07) V-U	2.5 mm ²
Flexible, min. H05(07) V-K	0.2 mm ²
Flexible, max. H05(07) V-K	2.5 mm ²
w. plastic collar ferrule, DIN 46228 pt 4, 0.2 mm ² min.	
w. plastic collar ferrule, DIN 46228 pt 4, 2.5 mm ² max.	
w. wire end ferrule, DIN 46228 pt 1, min.	0.2 mm ²
w. wire end ferrule, DIN 46228 pt 1, max.	2.5 mm ²
Plug gauge in accordance with EN 60999 a x b; ø	2.8 mm x 2.0 mm; 2.4 mm

Creation date May 3, 2020 8:23:45 PM CEST

Catalogue status 17.04.2020 / We reserve the right to make technical changes.

**OMNIMATE Signal - series BL/SL 5.08
SLS 5.08/08/180 SN OR BX**

Weidmüller Interface GmbH & Co. KG
 Klingenbergstraße 26
 D-32758 Detmold
 Germany
 Fon: +49 5231 14-0
 Fax: +49 5231 14-292083
 www.weidmueller.com

Technical data

Clampable conductor	Cross-section for conductor connection	Type	fine-wired
		nominal	0.5 mm ²
wire end ferrule		Stripping length	nominal 6 mm
		Recommended wire-end ferrule	H0.5/6
Clampable conductor	Cross-section for conductor connection	Type	fine-wired
		nominal	1 mm ²
wire end ferrule		Stripping length	nominal 6 mm
		Recommended wire-end ferrule	H1.0/6
Clampable conductor	Cross-section for conductor connection	Type	fine-wired
		nominal	1.5 mm ²
wire end ferrule		Stripping length	nominal 7 mm
		Recommended wire-end ferrule	H1.5/7
Clampable conductor	Cross-section for conductor connection	Type	fine-wired
		nominal	2.5 mm ²
wire end ferrule		Stripping length	nominal 7 mm
		Recommended wire-end ferrule	H2.5/7
Clampable conductor	Cross-section for conductor connection	Type	fine-wired
		nominal	0.75 mm ²
wire end ferrule		Stripping length	nominal 6 mm
		Recommended wire-end ferrule	H0.75/6
Reference text	The outside diameter of the plastic collar should not be larger than the pitch (P). Length of ferrules is to be chosen depending on the product and the rated voltage.		
Max. clamping range	3.31 mm ²		

Rated data acc. to IEC

tested acc. to standard	IEC 60664-1, IEC 61984	Rated current, min. number of poles (Tu=20°C)	21.5 A
Rated current, max. number of poles (Tu=20°C)	16 A	Rated current, min. number of poles (Tu=40°C)	18 A
Rated current, max. number of poles (Tu=40°C)	14 A	Rated voltage for surge voltage class / pollution degree II/2	400 V
Rated voltage for surge voltage class / pollution degree III/2	320 V	Rated voltage for surge voltage class / pollution degree III/3	250 V
Rated impulse voltage for surge voltage class/ pollution degree II/2	4 kV	Rated impulse voltage for surge voltage class/ pollution degree III/2	4 kV
Rated impulse voltage for surge voltage class/ contamination degree III/3	4 kV	Short-time withstand current resistance	3 x 1s with 120 A

Rated data acc. to CSA

Institute (CSA)		Certificate No. (CSA)	200039-1121690
Rated voltage (Use group B / CSA)	300 V	Rated voltage (Use group D / CSA)	300 V
Rated current (Use group B / CSA)	15 A	Rated current (Use group D / CSA)	10 A
Wire cross-section, AWG, min.	AWG 26	Wire cross-section, AWG, max.	AWG 12
Reference to approval values	Specifications are maximum values, details - see approval certificate.		

Data sheet

**OMNIMATE Signal - series BL/SL 5.08
SLS 5.08/08/180 SN OR BX**

Weidmüller Interface GmbH & Co. KG
Klingenbergstraße 26
D-32758 Detmold
Germany
Fon: +49 5231 14-0
Fax: +49 5231 14-292083
www.weidmueller.com

Technical data

Rated data acc. to UL 1059

Institute (UR)		Certificate No. (UR)	E60693
Rated voltage (Use group B / UL 1059)	300 V	Rated voltage (Use group D / UL 1059)	300 V
Rated current (Use group B / UL 1059)	14 A	Rated current (Use group D / UL 1059)	10 A
Wire cross-section, AWG, min.	AWG 26	Wire cross-section, AWG, max.	AWG 12
Reference to approval values	Specifications are maximum values, details - see approval certificate.		

Packing

Packaging	Box	VPE length	30 mm
VPE width	135 mm	VPE height	350 mm

Classifications

ETIM 6.0	EC002638	ETIM 7.0	EC002638
eClass 9.0	27-44-03-09	eClass 9.1	27-44-03-09
eClass 10.0	27-44-03-09	UNSPSC	30-21-18-10

Notes

Notes	<ul style="list-style-type: none"> • Additional colours on request • Rated current related to rated cross-section & min. No. of poles. • Wire end ferrule without plastic collar to DIN 46228/1 • Wire end ferrule with plastic collar to DIN 46228/4 • P on drawing = pitch • Rated data refer only to the component itself. Clearance and creepage distances to other components are to be designed in accordance with the relevant application standards.
-------	--

IPC conformity	Conformity: The products are developed, manufactured and delivered according international recognized standards and norms and comply with the assured properties in the data sheet resp. fulfill decorative properties in accordance with IPC-A-610 "Class 2". Further claims on the products can be evaluated on request.
----------------	--

Approvals

Approvals	
ROHS	Conform

Data sheet**OMNIMATE Signal - series BL/SL 5.08
SLS 5.08/08/180 SN OR BX**

Weidmüller Interface GmbH & Co. KG
Klingenbergstraße 26
D-32758 Detmold
Germany
Fon: +49 5231 14-0
Fax: +49 5231 14-292083
www.weidmueller.com

Technical data**Downloads**

Approval/Certificate/Document of Conformity	Declaration of the Manufacturer
Brochure/Catalogue	FL DRIVES EN MB DEVICE MANUF. EN FL DRIVES DE CAT 2 PORTFOLIOGUIDE EN FL BUILDING SAFETY EN FL APPL LED LIGHTING EN FL INDUSTR.CONTROLS EN FL MACHINE SAFETY EN FL HEATING ELECTR EN FL APPL INVERTER EN FL BASE STATION EN FL ELEVATOR EN FL POWER SUPPLY EN FL 72H SAMPLE SER EN PO OMNIMATE EN
Engineering Data	STEP

**OMNIMATE Signal - series BL/SL 5.08
SLS 5.08/08/180 SN OR BX**

Weidmüller Interface GmbH & Co. KG
Klingenbergstraße 26
D-32758 Detmold
Germany
Fon: +49 5231 14-0
Fax: +49 5231 14-292083
www.weidmueller.com

Drawings

Dimensional drawing

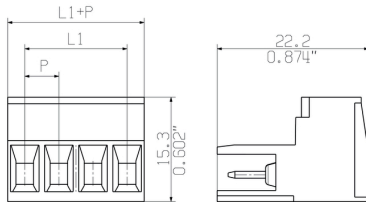

Graph

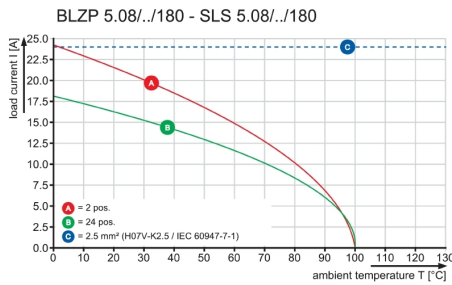

Graph

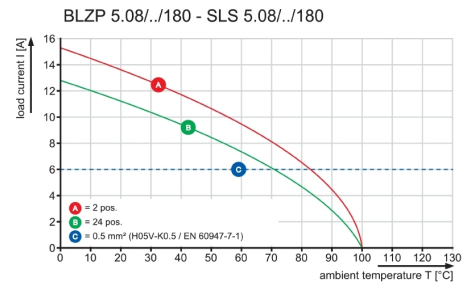

Graph

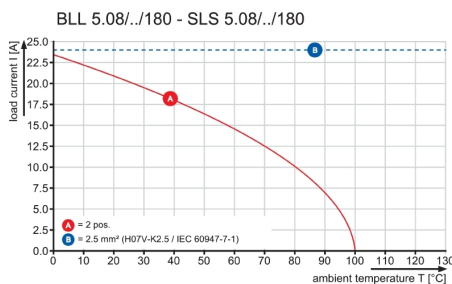

**OMNIMATE Signal - series BL/SL 5.08
SLS 5.08/08/180 SN OR BX**

Weidmüller Interface GmbH & Co. KG
Klingenbergstraße 26
D-32758 Detmold
Germany
Fon: +49 5231 14-0
Fax: +49 5231 14-292083
www.weidmueller.com

Mating connector (conditionally pluggable)

BLT 5.08HC/180B

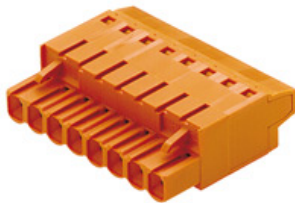

Female plugs with TOP screw connection system for connecting wires with straight 180° outlet direction. The female connectors provide space for labelling and can be coded. HC = High Current.

General ordering data

Type	BLT 5.08HC/08/180B SN O ...	Version	Product data	Packaging
Order No.	1502460000	PCB plug-in connector, female plug, 5.08 mm, Number of poles: 8,	IEC: 400 V / 27 A / 0.2 - 2.5 mm ²	Box
GTIN (EAN)	4008190147334	180°, TOP connection, Clamping range, max. : 2.5 mm ² , Box	UL: 300 V / 17 A / AWG 26 - AWG 14	
Qty.	42 pc(s).			

**OMNIMATE Signal - series BL/SL 5.08
SLS 5.08/08/180 SN OR BX**

Weidmüller Interface GmbH & Co. KG
Klingenbergstraße 26
D-32758 Detmold
Germany
Fon: +49 5231 14-0
Fax: +49 5231 14-292083
www.weidmueller.com

Mating connector (fully pluggable)
BLZP 5.08HC/225 SN

Clamping-yoke connection with right-angled (90° or 270°) or angled (225°) outlet direction. The female connectors provide space for labelling and can be coded. Fastened by means of a flange or release latch. They also provide an integrated plus/minus screw, protection against faulty insertion of the wire, and they are delivered with open clamping yokes. HC = High Current.

General ordering data

Type	BLZP 5.08HC/08/225 SN B ...	Version	Product data	Packaging
Order No.	1946620000	PCB plug-in connector, female plug, 5.08 mm, Number of poles: 8,	IEC: 400 V / 17.5 A / 0.2 - 4 mm ²	Box
GTIN (EAN)	4032248622399	225°, Clamping yoke connection, Clamping range, max. : 4 mm ² , Box	UL: 300 V / 15 A / AWG 26 - AWG 12	
Qty.	42 pc(s).			
Type	BLZP 5.08HC/08/225 SN O ...	Version	Product data	Packaging
Order No.	1946310000	PCB plug-in connector, female plug, 5.08 mm, Number of poles: 8,	IEC: 400 V / 17.5 A / 0.2 - 4 mm ²	Box
GTIN (EAN)	4032248621880	225°, Clamping yoke connection, Clamping range, max. : 4 mm ² , Box	UL: 300 V / 15 A / AWG 26 - AWG 12	
Qty.	42 pc(s).			

BLZP 5.08HC/270 SN

Female plugs with clamping-yoke connection for connecting wires with a right-angle (90° or 270°) outlet direction. The female connectors provide space for labelling and can be coded. Fastened by means of a flange or release latch. They also provide an integrated plus/minus screw, protection against faulty insertion of the wire, and they are delivered with open clamping yokes. HC = High Current.

General ordering data

Type	BLZP 5.08HC/08/270 SN O ...	Version	Product data	Packaging
Order No.	1948850000	PCB plug-in connector, female plug, 5.08 mm, Number of poles: 8,	IEC: 400 V / 23 A / 0.2 - 4 mm ²	Box
GTIN (EAN)	4032248626304	270°, Clamping yoke connection, Clamping range, max. : 4 mm ² , Box	UL: 300 V / 20 A / AWG 26 - AWG 12	
Qty.	42 pc(s).			
Type	BLZP 5.08HC/08/270 SN B ...	Version	Product data	Packaging
Order No.	1949080000	PCB plug-in connector, female plug, 5.08 mm, Number of poles: 8,	IEC: 400 V / 23 A / 0.2 - 4 mm ²	Box
GTIN (EAN)	4032248626533	270°, Clamping yoke connection, Clamping range, max. : 4 mm ² , Box	UL: 300 V / 20 A / AWG 26 - AWG 12	
Qty.	42 pc(s).			

**OMNIMATE Signal - series BL/SL 5.08
SLS 5.08/08/180 SN OR BX**

Weidmüller Interface GmbH & Co. KG
Klingenbergstraße 26
D-32758 Detmold
Germany
Fon: +49 5231 14-0
Fax: +49 5231 14-292083
www.weidmueller.com

Mating connector (fully pluggable)
BLF 5.08HC/180DF SN

Just as reliable as the millionfold proven original and featuring innovative details:
The BLF 5.08HC PUSH IN version of the BLZP 5.08HC female connector is not only different in terms of connection system; it also has a more compact design. Weidmüller's innovative PUSH IN spring connection system stands for the future of easy and tool-free wire connection. HC = High Current.
In terms of versatility, the BLF 5.08HC offers just as much as the version which served as a model:

- 3 tested-and-proven wire outlet directions provide the usual flexibility for application-specific design
- 4 flange variations and the patented release latch allow the locking concept to be based on the requirements of the user
- Use the BLF 5.08HC and SL 5.08HC plug combination to reach the max. rated specifications

General ordering data

Type	BLF 5.08HC/08/180DF SN ...	Version	Product data	Packaging
Order No.	1353300000	PCB plug-in connector, female plug, 5.08 mm, Number of poles: 8,	IEC: 400 V / 24 A / 0.2 - 2.5 mm ²	Box
GTIN (EAN)	4050118155679	180°, PUSH IN, Spring connection, Clamping range, max. : 3.31 mm ² , UL: 300 V / 18.5 A / AWG 26 - AWG		
Qty.	24 pc(s).	Box	12	

BLZP 5.08HC/180 SN

Female plug with clamping-yoke screw system for connecting wires with straight (180°) outlet direction. The female connectors provide space for labelling and can be coded. Fastened by means of a flange or release latch. They also provide an integrated plus/minus screw, protection against faulty insertion of the wire, and they are delivered with open clamping yokes. HC = High Current.

General ordering data

Type	BLZP 5.08HC/08/180 SN B ...	Version	Product data	Packaging
Order No.	1943870000	PCB plug-in connector, female plug, 5.08 mm, Number of poles: 8,	IEC: 400 V / 23 A / 0.2 - 4 mm ²	Box
GTIN (EAN)	4032248617913	180°, Clamping yoke connection, Clamping range, max. : 4 mm ² , Box	UL: 300 V / 20 A / AWG 26 - AWG 12	
Qty.	42 pc(s).			
Type	BLZP 5.08HC/08/180 SN O ...	Version	Product data	Packaging
Order No.	1943640000	PCB plug-in connector, female plug, 5.08 mm, Number of poles: 8,	IEC: 400 V / 23 A / 0.2 - 4 mm ²	Box
GTIN (EAN)	4032248617647	180°, Clamping yoke connection, Clamping range, max. : 4 mm ² , Box	UL: 300 V / 20 A / AWG 26 - AWG 12	
Qty.	42 pc(s).			

**OMNIMATE Signal - series BL/SL 5.08
SLS 5.08/08/180 SN OR BX**

Weidmüller Interface GmbH & Co. KG
Klingenbergstraße 26
D-32758 Detmold
Germany
Fon: +49 5231 14-0
Fax: +49 5231 14-292083
www.weidmuller.com

Mating connector (fully pluggable)**BLF 5.08HC/180 SN**

Just as reliable as the millionfold proven original and featuring innovative details:

The BLF 5.08HC PUSH IN version of the BLZP 5.08HC female connector is not only different in terms of connection system; it also has a more compact design. Weidmüller's innovative PUSH IN spring connection system stands for the future of easy and tool-free wire connection. HC = High Current.

In terms of versatility, the BLF 5.08HC offers just as much as the version which served as a model:

- 3 tested-and-proven wire outlet directions provide the usual flexibility for application-specific design
- 4 flange variations and the patented release latch allow the locking concept to be based on the requirements of the user
- Use the BLF 5.08HC and SL 5.08HC plug combination to reach the max. rated specifications

General ordering data

Type	BLF 5.08HC/08/180 SN OR ...	Version	Product data	Packaging
Order No.	1013750000	PCB plug-in connector, female plug, 5.08 mm, Number of poles: 8,	IEC: 400 V / 24 A / 0.2 - 2.5 mm ²	Box
GTIN (EAN)	4032248721863	180°, PUSH IN, Spring connection, Clamping range, max. : 3.31 mm ² ,	UL: 300 V / 18.5 A / AWG 26 - AWG	
Qty.	42 pc(s).	Box	12	
Type	BLF 5.08HC/08/180 SN BK ...	Version	Product data	Packaging
Order No.	1013490000	PCB plug-in connector, female plug, 5.08 mm, Number of poles: 8,	IEC: 400 V / 24 A / 0.2 - 2.5 mm ²	Box
GTIN (EAN)	4032248721641	180°, PUSH IN, Tension-clamp connection, Clamping range, max. :	UL: 300 V / 18.5 A / AWG 26 - AWG	
Qty.	42 pc(s).	3.31 mm ² , Box	12	

BLZP 5.08HC/90 SN

Female plugs with clamping-yoke connection for connecting wires with a right-angle (90° or 270°) outlet direction. The female connectors provide space for labelling and can be coded. Fastened by means of a flange or release latch. They also provide an integrated plus/minus screw, protection against faulty insertion of the wire, and they are delivered with open clamping yokes. HC = High Current.

General ordering data

Type	BLZP 5.08HC/08/90 SN BK ...	Version	Product data	Packaging
Order No.	1948300000	PCB plug-in connector, female plug, 5.08 mm, Number of poles: 8,	IEC: 400 V / 23 A / 0.2 - 4 mm ²	Box
GTIN (EAN)	4032248624829	90°, Clamping yoke connection, Clamping range, max. : 4 mm ² , Box	UL: 300 V / 20 A / AWG 26 - AWG 12	
Qty.	42 pc(s).			
Type	BLZP 5.08HC/08/90 SN OR ...	Version	Product data	Packaging
Order No.	1948060000	PCB plug-in connector, female plug, 5.08 mm, Number of poles: 8,	IEC: 400 V / 23 A / 0.2 - 4 mm ²	Box
GTIN (EAN)	4032248624287	90°, Clamping yoke connection, Clamping range, max. : 4 mm ² , Box	UL: 300 V / 20 A / AWG 26 - AWG 12	
Qty.	42 pc(s).			

**OMNIMATE Signal - series BL/SL 5.08
SLS 5.08/08/180 SN OR BX**

Weidmüller Interface GmbH & Co. KG
Klingenbergstraße 26
D-32758 Detmold
Germany
Fon: +49 5231 14-0
Fax: +49 5231 14-292083
www.weidmueller.com

Mating connector (fully pluggable)
BLC 5.08R

Female plugs with crimp wire connection system. The female plugs provide space for labelling and can be coded.

General ordering data

Type	BLC 5.08/08/180R OR BX	Version	Product data	Packaging
Order No.	1610550000	PCB plug-in connector, female plug, 5.08 mm, Number of poles: 8,	IEC: 400 V / 21 A	Box
GTIN (EAN)	4008190080563	180°, Crimp connection, Clamping range, max. : 2.5 mm ² , Box	UL: 300 V / 10 A / AWG 26 - AWG 14	
Qty.	50 pc(s).			
Type	BLC 5.08/08/180R BK BX	Version	Product data	Packaging
Order No.	1712020000	PCB plug-in connector, female plug, 5.08 mm, Number of poles: 8,	IEC: 400 V / 21 A	Box
GTIN (EAN)	4008190935030	180°, Crimp connection, Clamping range, max. : 2.5 mm ² , Box	UL: 300 V / 10 A / AWG 26 - AWG 14	
Qty.	50 pc(s).			

BLF 5.08HC/90 SN

Just as reliable as the millionfold proven original and featuring innovative details:
The BLF 5.08HC PUSH IN version of the BLZP 5.08HC female connector is not only different in terms of connection system; it also has a more compact design. Weidmüller's innovative PUSH IN spring connection system stands for the future of easy and tool-free wire connection. HC = High Current.
In terms of versatility, the BLF 5.08HC offers just as much as the version which served as a model:

- 3 tested-and-proven wire outlet directions provide the usual flexibility for application-specific design
- 4 flange variations and the patented release latch allow the locking concept to be based on the requirements of the user
- Use the BLF 5.08HC and SL 5.08HC plug combination to reach the max. rated specifications

General ordering data

Type	BLF 5.08HC/08/90 SN BK ...	Version	Product data	Packaging
Order No.	1000090001	PCB plug-in connector, female plug, 5.08 mm, Number of poles: 8,	IEC: 400 V / 24 A / 0.2 - 2.5 mm ²	Box
GTIN (EAN)	4032248690022	90°, PUSH IN, Spring connection, Clamping range, max. : 3.31 mm ² ,	UL: 300 V / 18.5 A / AWG 26 - AWG 12	
Qty.	42 pc(s).	Box		
Type	BLF 5.08HC/08/90 SN OR ...	Version	Product data	Packaging
Order No.	1001590000	PCB plug-in connector, female plug, 5.08 mm, Number of poles: 8,	IEC: 400 V / 24 A / 0.2 - 2.5 mm ²	Box
GTIN (EAN)	4032248693399	90°, PUSH IN, Spring connection, Clamping range, max. : 3.31 mm ² ,	UL: 300 V / 18.5 A / AWG 26 - AWG 12	
Qty.	42 pc(s).	Box		

**OMNIMATE Signal - series BL/SL 5.08
SLS 5.08/08/180 SN OR BX**

Weidmüller Interface GmbH & Co. KG
Klingenbergstraße 26
D-32758 Detmold
Germany
Fon: +49 5231 14-0
Fax: +49 5231 14-292083
www.weidmueller.com

Mating connector (fully pluggable)
BLZF 5.08/180

Female plugs with tension-clamp wire connection system, straight 180° outlet direction. The female plugs provide space for labelling and can be coded.

General ordering data

Type	BLZF 5.08/08/180 SN DKG ...	Version	Product data	Packaging
Order No.	1707980000	PCB plug-in connector, female plug, 5.08 mm, Number of poles: 8,	IEC: 400 V / 17 A / 0.2 - 2.5 mm ²	Box
GTIN (EAN)	4008190317393	180°, Tension-clamp connection, Clamping range, max. : 3.31 mm ² ,	UL: 300 V / 15 A / AWG 26 - AWG 12	
Qty.	42 pc(s).	Box		

BLDT 5.08

Female plugs with two clamping-yoke screw connections per pole for wire connections with 90° and 270° outlet directions. The female plugs provide space for labelling and can be coded.

General ordering data

Type	BLDT 5.08/08/- SN BK BX	Version	Product data	Packaging
Order No.	1660770000	PCB plug-in connector, female plug, 5.08 mm, Number of poles: 8,	IEC: 400 V / 14 A / 0.2 - 2.5 mm ²	Box
GTIN (EAN)	4008190417222	180°, Clamping yoke connection, Clamping range, max. : 3.31 mm ² ,	UL: 300 V / 10 A / AWG 26 - AWG 12	
Qty.	35 pc(s).	Box		
Type	BLDT 5.08/08/- SN OR BX	Version	Product data	Packaging
Order No.	1644790000	PCB plug-in connector, female plug, 5.08 mm, Number of poles: 8,	IEC: 400 V / 14 A / 0.2 - 2.5 mm ²	Box
GTIN (EAN)	4008190284008	180°, Clamping yoke connection, Clamping range, max. : 3.31 mm ² ,	UL: 300 V / 10 A / AWG 26 - AWG 12	
Qty.	35 pc(s).	Box		

**OMNIMATE Signal - series BL/SL 5.08
SLS 5.08/08/180 SN OR BX**

Weidmüller Interface GmbH & Co. KG
Klingenbergstraße 26
D-32758 Detmold
Germany
Fon: +49 5231 14-0
Fax: +49 5231 14-292083
www.weidmueller.com

Mating connector (fully pluggable)
BLF 5.08HC/270 SN

Just as reliable as the millionfold proven original and featuring innovative details:

The BLF 5.08HC PUSH IN version of the BLZP 5.08HC female connector is not only different in terms of connection system; it also has a more compact design. Weidmüller's innovative PUSH IN spring connection system stands for the future of easy and tool-free wire connection. HC = High Current.

In terms of versatility, the BLF 5.08HC offers just as much as the version which served as a model:

- 3 tested-and-proven wire outlet directions provide the usual flexibility for application-specific design
- 4 flange variations and the patented release latch allow the locking concept to be based on the requirements of the user
- Use the BLF 5.08HC and SL 5.08HC plug combination to reach the max. rated specifications

General ordering data

Type	BLF 5.08HC/08/270 SN OR ...	Version	Product data	Packaging
Order No.	1982760000	PCB plug-in connector, female plug, 5.08 mm, Number of poles: 8,	IEC: 400 V / 24 A / 0.2 - 2.5 mm ²	Box
GTIN (EAN)	4032248686858	270°, PUSH IN, Spring connection, Clamping range, max. : 3.31 mm ² , UL: 300 V / 18.5 A / AWG 26 - AWG		
Qty.	42 pc(s).	Box	12	
Type	BLF 5.08HC/08/270 SN BK ...	Version	Product data	Packaging
Order No.	1981990000	PCB plug-in connector, female plug, 5.08 mm, Number of poles: 8,	IEC: 400 V / 24 A / 0.2 - 2.5 mm ²	Box
GTIN (EAN)	4032248684687	270°, PUSH IN, Spring connection, Clamping range, max. : 3.31 mm ² , UL: 300 V / 18.5 A / AWG 26 - AWG		
Qty.	42 pc(s).	Box	12	

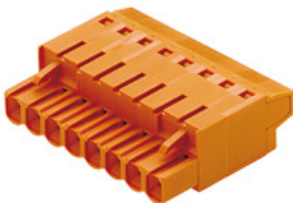
BLT 5.08HC

Female plugs with TOP screw connection system for connecting wires with straight 180° outlet direction. The female connectors provide space for labelling and can be coded. HC = High Current.

General ordering data

Type	BLT 5.08HC/08/180 SN GY ...	Version	Product data	Packaging
Order No.	1500100000	PCB plug-in connector, female plug, 5.08 mm, Number of poles: 8,	IEC: 400 V / 27 A / 0.2 - 2.5 mm ²	Box
GTIN (EAN)	4008190285210	180°, TOP connection, Clamping range, max. : 2.5 mm ² , Box	UL: 300 V / 17 A / AWG 26 - AWG 14	
Qty.	42 pc(s).			
Type	BLT 5.08HC/08/180 SN BL ...	Version	Product data	Packaging
Order No.	1500180000	PCB plug-in connector, female plug, 5.08 mm, Number of poles: 8,	IEC: 400 V / 27 A / 0.2 - 2.5 mm ²	Box
GTIN (EAN)	4008190368654	180°, TOP connection, Clamping range, max. : 2.5 mm ² , Box	UL: 300 V / 17 A / AWG 26 - AWG 14	
Qty.	42 pc(s).			

**OMNIMATE Signal - series BL/SL 5.08
SLS 5.08/08/180 SN OR BX**

Weidmüller Interface GmbH & Co. KG
Klingenbergstraße 26
D-32758 Detmold
Germany
Fon: +49 5231 14-0
Fax: +49 5231 14-292083
www.weidmueller.com

Mating connector (fully pluggable)
BLZ 5.08/180

Female plugs with clamping-yoke screw for wire connection with straight (180°) outlet direction. The female plugs provide space for labelling and can be coded.

General ordering data

Type	BLZ 5.08/08/180 SN GY BX	Version	Product data	Packaging
Order No.	1527000000	PCB plug-in connector, female plug, 5.08 mm, Number of poles: 8,	IEC: 400 V / 19 A / 0.2 - 2.5 mm ²	Box
GTIN (EAN)	4008190017613	180°, Clamping yoke connection, Clamping range, max. : 3.31 mm ² ,	UL: 300 V / 15 A / AWG 26 - AWG 12	
Qty.	50 pc(s).	Box		
Type	BLZ 5.08/08/180 SN OR B ...	Version	Product data	Packaging
Order No.	1653451001	PCB plug-in connector, female plug, 5.08 mm, Number of poles: 8,	IEC: 400 V / 19 A / 0.2 - 2.5 mm ²	Box
GTIN (EAN)	4008190404826	180°, Clamping yoke connection, Clamping range, max. : 3.31 mm ² ,	UL: 300 V / 15 A / AWG 26 - AWG 12	
Qty.	42 pc(s).	Box		
Type	BLZ 5.08/08/180 SN DKG ...	Version	Product data	Packaging
Order No.	1527050000	PCB plug-in connector, female plug, 5.08 mm, Number of poles: 8,	IEC: 400 V / 19 A / 0.2 - 2.5 mm ²	Box
GTIN (EAN)	4008190191160	180°, Clamping yoke connection, Clamping range, max. : 3.31 mm ² ,	UL: 300 V / 15 A / AWG 26 - AWG 12	
Qty.	50 pc(s).	Box		

BLZP 5.08HC/225B SN

Clamping-yoke connection with right-angled (90° or 270°) or angled (225°) outlet direction. The female connectors provide space for labelling and can be coded. Fastened by means of a flange or release latch. The also provide an integrated plus/minus screw, protection against faulty insertion of the wire, and they are delivered with open clamping yokes. HC = High Current.

General ordering data

Type	BLZP 5.08HC/08/225B SN ...	Version	Product data	Packaging
Order No.	1945810000	PCB plug-in connector, female plug, 5.08 mm, Number of poles: 8,	IEC: 400 V / 17.5 A / 0.2 - 4 mm ²	Box
GTIN (EAN)	4032248621286	225°, Clamping yoke connection, Clamping range, max. : 4 mm ² , Box	UL: 300 V / 15 A / AWG 26 - AWG 12	
Qty.	42 pc(s).			
Type	BLZP 5.08HC/08/225B SN ...	Version	Product data	Packaging
Order No.	1946040000	PCB plug-in connector, female plug, 5.08 mm, Number of poles: 8,	IEC: 400 V / 17.5 A / 0.2 - 4 mm ²	Box
GTIN (EAN)	4032248621576	225°, Clamping yoke connection, Clamping range, max. : 4 mm ² , Box	UL: 300 V / 15 A / AWG 26 - AWG 12	
Qty.	42 pc(s).			

**OMNIMATE Signal - series BL/SL 5.08
SLS 5.08/08/180 SN OR BX**

Weidmüller Interface GmbH & Co. KG
Klingenbergstraße 26
D-32758 Detmold
Germany
Fon: +49 5231 14-0
Fax: +49 5231 14-292083
www.weidmueller.com

Mating connector (fully pluggable)
BLL 5.08/180

Female header for PCB mounting. The solder pin length is optimised for wave flow soldering.

General ordering data

Type	BLL 5.08/08/180 3.2 SN ...	Version	Product data	Packaging
Order No.	1630770000	PCB plug-in connector, female header, closed side, THT solder	IEC: 400 V / 23 A	Box
GTIN (EAN)	4008190204198	connection, 5.08 mm, Number of poles: 8, 180°, Solder pin length (l):	UL: 300 V / 15 A	
Qty.	42 pc(s).	3.2 mm, tinned, orange, Box		
Type	BLL 5.08/08/180 4.5 SN ...	Version	Product data	Packaging
Order No.	1646310000	PCB plug-in connector, female header, closed side, THT solder	IEC: 400 V / 23 A	Box
GTIN (EAN)	4008190285654	connection, 5.08 mm, Number of poles: 8, 180°, Solder pin length (l):	UL: 300 V / 15 A	
Qty.	42 pc(s).	4.5 mm, tinned, black, Box		

BLL 5.08/90

Female header for PCB mounting. The solder pin length is optimised for wave flow soldering.

General ordering data

Type	BLL 5.08/08/90 3.2 SN O ...	Version	Product data	Packaging
Order No.	1623000000	PCB plug-in connector, female header, closed side, THT solder	IEC: 400 V / 23 A	Box
GTIN (EAN)	4008190194055	connection, 5.08 mm, Number of poles: 8, 90°, Solder pin length (l):	UL: 300 V / 15 A	
Qty.	42 pc(s).	3.2 mm, tinned, orange, Box		
Type	BLL 5.08/08/90 3.2 SN B ...	Version	Product data	Packaging
Order No.	1730190000	PCB plug-in connector, female header, closed side, THT solder	IEC: 400 V / 23 A	Box
GTIN (EAN)	4050118007008	connection, 5.08 mm, Number of poles: 8, 90°, Solder pin length (l):	UL: 300 V / 15 A	
Qty.	42 pc(s).	3.2 mm, tinned, black, Box		

**OMNIMATE Signal - series BL/SL 5.08
SLS 5.08/08/180 SN OR BX**

Weidmüller Interface GmbH & Co. KG
Klingenbergstraße 26
D-32758 Detmold
Germany
Fon: +49 5231 14-0
Fax: +49 5231 14-292083
www.weidmuller.com

Mating connector (fully pluggable)
BLDT 5.08B

Female plugs with two clamping-yoke screw connections per pole for wire connections with 90° and 270° outlet directions. The female plugs provide space for labelling and can be coded.

General ordering data

Type	BLDT 5.08/08/-B SN OR BX	Version	Product data	Packaging
Order No.	1651800000	PCB plug-in connector, female plug, 5.08 mm, Number of poles: 8,	IEC: 400 V / 14 A / 0.2 - 2.5 mm ²	Box
GTIN (EAN)	4008190400484	180°, Clamping yoke connection, Clamping range, max. : 3.31 mm ² ,	UL: 300 V / 10 A / AWG 26 - AWG 12	
Qty.	35 pc(s).	Box		
Type	BLDT 5.08/08/-B SN BK BX	Version	Product data	Packaging
Order No.	1673840000	PCB plug-in connector, female plug, 5.08 mm, Number of poles: 8,	IEC: 400 V / 14 A / 0.2 - 2.5 mm ²	Box
GTIN (EAN)	4008190435578	180°, Clamping yoke connection, Clamping range, max. : 3.31 mm ² ,	UL: 300 V / 10 A / AWG 26 - AWG 12	
Qty.	50 pc(s).	Box		

BLDF 5.08/180 SN



The powerful daisy-chain solution for high-performance signal bus applications is also suitable for 400V auxiliary power chains with 18.5A current-carrying capacity. The large clamping capacity (up to 2.5mm² wire cross-sections) is particularly beneficial for long bus cables or high currents because of the low voltage drop. Four flange variations, including the patented release latch, allow for user-friendly unplugging designs.

General ordering data

Type	BLDF 5.08/08/180 SN OR ...	Version	Product data	Packaging
Order No.	1001210000	PCB plug-in connector, female plug, 5.08 mm, Number of poles: 8,	IEC: 400 V / 20.8 A / 0.2 - 2.5 mm ²	Box
GTIN (EAN)	4032248817573	180°, PUSH IN, Spring connection, Clamping range, max. : 3.31 mm ² ,	UL: 300 V / 18.5 A / AWG 12 - AWG 26	
Qty.	28 pc(s).	Box		
Type	BLDF 5.08/08/180 SN BK ...	Version	Product data	Packaging
Order No.	1000920000	PCB plug-in connector, female plug, 5.08 mm, Number of poles: 8,	IEC: 400 V / 20.8 A / 0.2 - 2.5 mm ²	Box
GTIN (EAN)	4032248817092	180°, PUSH IN, Spring connection, Clamping range, max. : 3.31 mm ² ,	UL: 300 V / 18.5 A / AWG 12 - AWG 26	
Qty.	28 pc(s).	Box		

**OMNIMATE Signal - series BL/SL 5.08
SLS 5.08/08/180 SN OR BX**

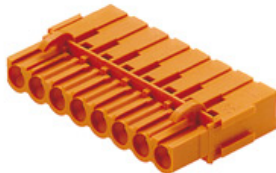
Weidmüller Interface GmbH & Co. KG
Klingenbergstraße 26
D-32758 Detmold
Germany
Fon: +49 5231 14-0
Fax: +49 5231 14-292083
www.weidmueller.com

Mating connector (fully pluggable)
BLC 5.08BR

Female plugs with crimp wire connection system. The female plugs provide space for labelling and can be coded.

General ordering data

Type	BLC 5.08/08/180BR OR BX	Version	Product data	Packaging
Order No.	1649430000	PCB plug-in connector, female plug, 5.08 mm, Number of poles: 8,	IEC: 400 V / 21 A	Box
GTIN (EAN)	4008190294540	180°, Crimp connection, Clamping range, max. : 2.5 mm ² , Box	UL: 300 V / 10 A / AWG 26 - AWG 14	
Qty.	50 pc(s).			
Type	BLC 5.08/08/180BR BK BX	Version	Product data	Packaging
Order No.	1712170000	PCB plug-in connector, female plug, 5.08 mm, Number of poles: 8,	IEC: 400 V / 21 A	Box
GTIN (EAN)	4008190935184	180°, Crimp connection, Clamping range, max. : 2.5 mm ² , Box	UL: 300 V / 10 A / AWG 26 - AWG 14	
Qty.	50 pc(s).			

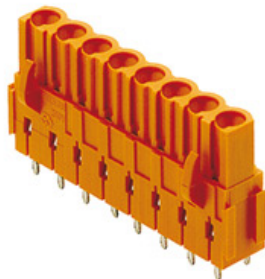
BLL 5.08/180B

Female header for PCB mounting. The solder pin length is optimised for wave flow soldering.

General ordering data

Type	BLL 5.08/08/180B 3.2SN ...	Version	Product data	Packaging
Order No.	1682790000	PCB plug-in connector, female header, Dovetails for fixing blocks, THT	IEC: 400 V / 23 A	Box
GTIN (EAN)	4008190474553	solder connection, 5.08 mm, Number of poles: 8, 180°, Solder pin	UL: 300 V / 15 A	
Qty.	42 pc(s).	length (l): 3.2 mm, tinned, orange, Box		

OMNIMATE Signal - series BL/SL 5.08 SLS 5.08/08/180 SN OR BX

Weidmüller Interface GmbH & Co. KG
Klingenbergstraße 26
D-32758 Detmold
Germany
Fon: +49 5231 14-0
Fax: +49 5231 14-292083
www.weidmueller.com

Accessories

Coding elements



Only connects what is supposed to be connected: the right connection at the right place.

Coding elements and locking devices clearly assign connecting elements during the manufacturing process and operation

The coding elements and locking devices are inserted prior to assembly or during the cable assembly phase. The Weidmüller alternative: configure online using the variant configurator to precode prior to delivery.

Incorrect assembly on the circuit board and incorrect plugging of connecting elements is no longer possible. The advantage: no troubleshooting during manufacture and no operational errors by the user.

General ordering data

Type	BLZ/SL KO BK BX	Version	Product data	Packaging
Order No.	1545710000	PCB plug-in connector, Accessories, Coding element, black, Number		Box
GTIN (EAN)	4008190087142	of poles: 1		
Qty.	50 pc(s).			
Type	BLZ/SL KO OR BX	Version	Product data	Packaging
Order No.	1573010000	PCB plug-in connector, Accessories, Coding element, orange, Number		Box
GTIN (EAN)	4008190048396	of poles: 1		
Qty.	100 pc(s).			

Additional accessories



No task is too small when creating the perfect solution.

Connections form just one part of the overall process. Small details are often the key to the perfect solution in applications where potentials are tested, grouped or even isolated.

A system is not a system without small but useful details:

- Test plugs - ensure reliable pick-up from diagnostic sockets
- Cross-connectors - ensure a stable electrical distribution contact directly at the connection
- Compartment partition elements - divide a large number of male connectors into several separate socket connector channels
- Locks and clips - optional vibration-resistant clip-on connection or mounting for male and female connectors

In tandem with the manufacturing process and application - more accessories = smaller workload

General ordering data

Type	SL AT OR	Version	Product data	Packaging
Order No.	1598300000	PCB plug-in connector, Accessories, Spacer, orange, Number of poles:		Box
GTIN (EAN)	4008190189266	1		
Qty.	100 pc(s).			

Data sheet

**OMNIMATE Signal - series BL/SL 5.08
SLS 5.08/08/180 SN OR BX**

Weidmüller Interface GmbH & Co. KG
 Klingenbergstraße 26
 D-32758 Detmold
 Germany
 Fon: +49 5231 14-0
 Fax: +49 5231 14-292083
 www.weidmueller.com

Accessories

Type	SL AT SW	Version	Product data	Packaging
Order No.	1770240000	PCB plug-in connector, Accessories, Spacer, black, Number of poles: 1		Box
GTIN (EAN)	4032248117710			
Qty.	100 pc(s).			

MASSE OHNE TOLERANZ SIND KEINE PRUEFMASSE
 DIMS. WITHOUT TOLERANCE ARE NOT CONTROL DIMS.

ALLGEMEINGUELTIGE KUNDENZEICHNUNG, AKTUELLER STAND NUR AUF ANFRAGE
 GENERAL CUSTOMER DRAWING, TOPICAL VERSION ONLY IF REQUIRED

DIE DEUTSCHE VERSION IST VERBINDLICH
 THE GERMAN VERSION IS BINDING

SHOWN: SLS 5.08/04/180

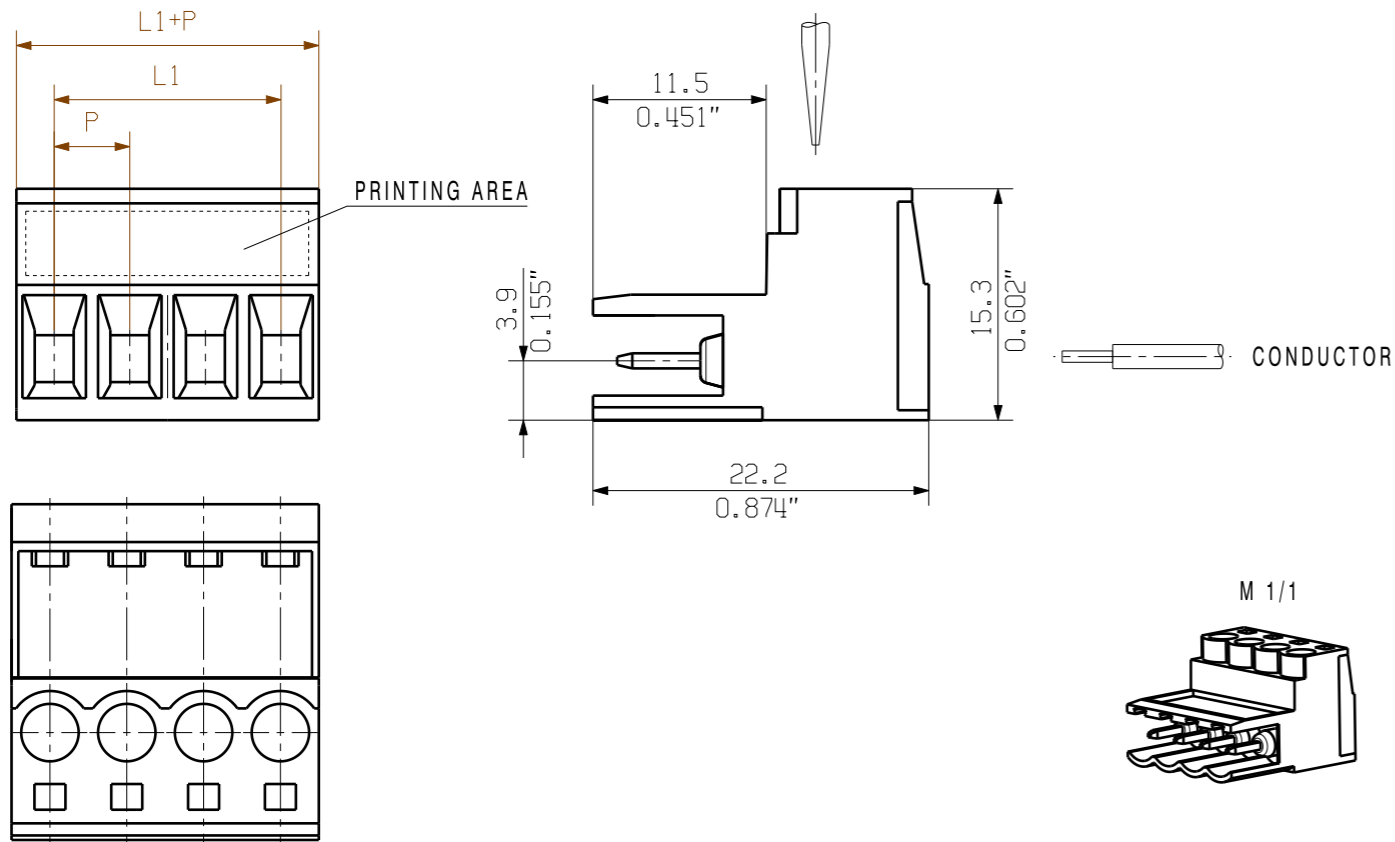

SHOWN: SLS 5.08/04/180DF

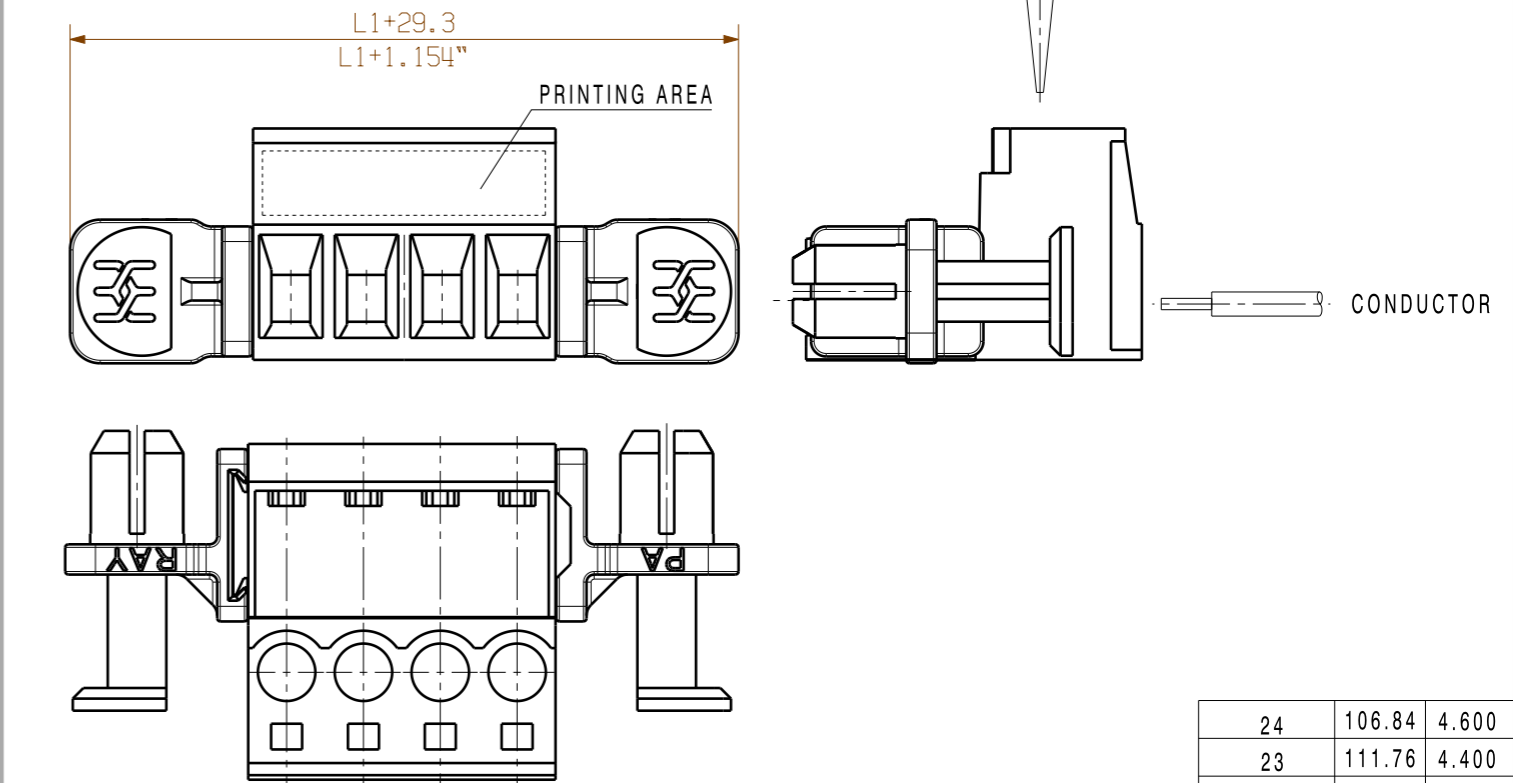

SHOWN: SLS 5.08/04/180B

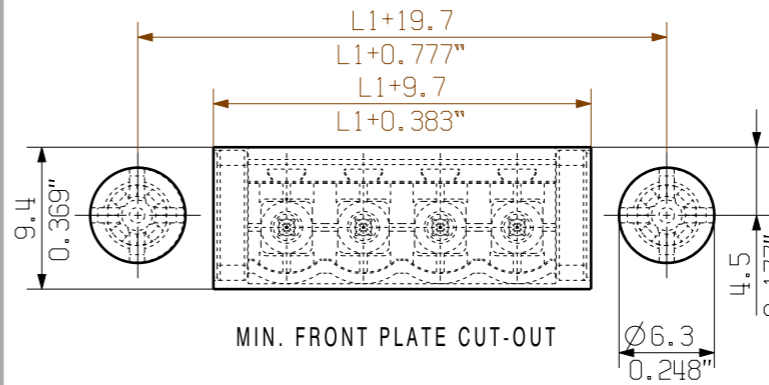
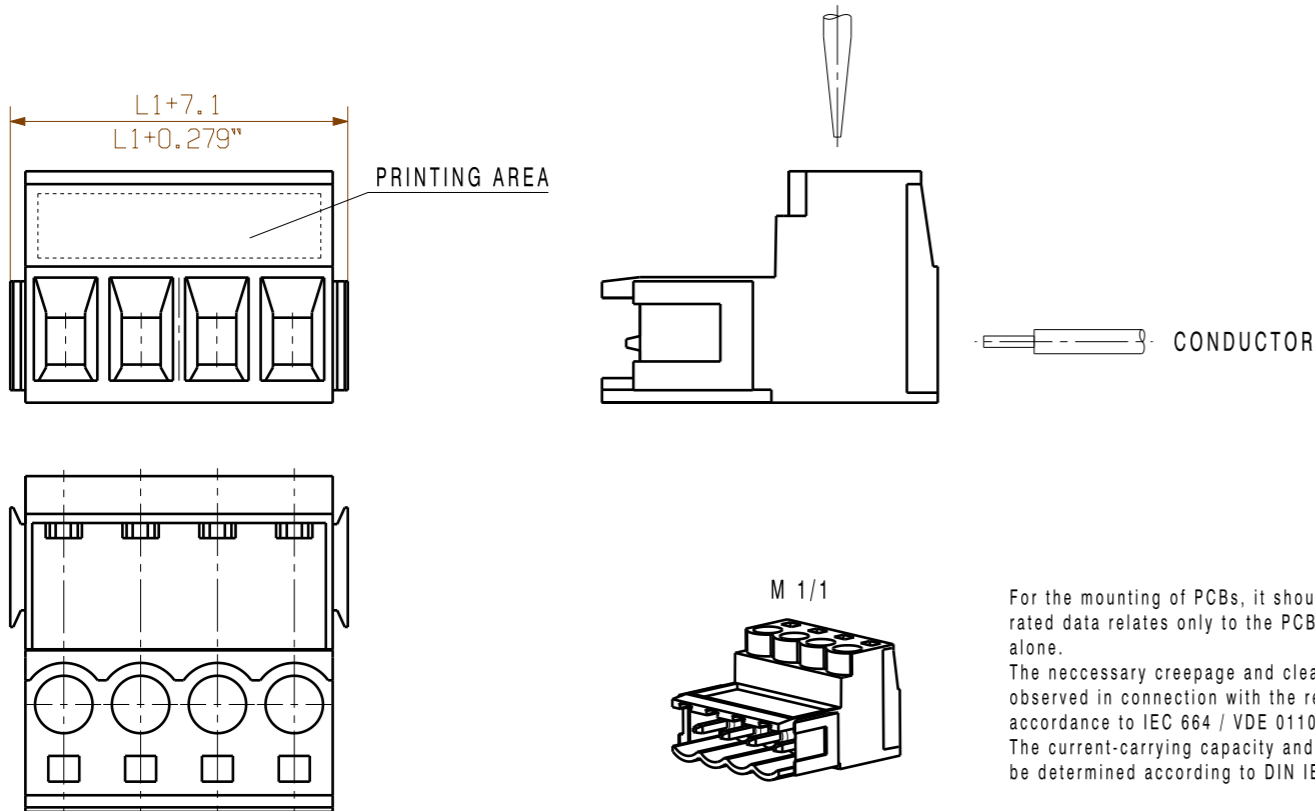

0.5-0.8	0.019-0.031	6.3	0.248
1.00	0.039	6.4	0.252
1.5	0.059	6.5	0.256
2.00	0.079	6.7	0.264
WANDDICKE WALL THICKNESS [mm]	WANDDICKE WALL THICKNESS [inch]	d [mm]	d [inch]

24	106.84	4.600
23	111.76	4.400
22	106.68	4.200
21	101.60	4.000
20	96.52	3.800
19	91.44	3.600
18	86.36	3.400
17	81.28	3.200
16	76.20	3.000
15	71.12	2.800
14	66.04	2.600
13	60.96	2.400
12	55.88	2.200
11	50.80	2.000
10	45.72	1.800
9	40.64	1.600
8	35.56	1.400
7	30.48	1.200
6	25.40	1.000
5	20.32	0.800
4	15.24	0.600
3	10.16	0.400
2	5.08	0.200
n POLES	L1 [mm]	L1 [inch]

For the mounting of PCBs, it should be noted that the rated data relates only to the PCB components alone.
 The necessary creepage and clearance paths must be observed in connection with the respective applicant in accordance to IEC 664 / VDE 0110.
 The current-carrying capacity and pitch tolerance is to be determined according to DIN IEC 326 part 3 very fine.

Weidmüller PCB components are tested to the DIN EN 61984 standard, and are valid for its field of application. Provided that the components are used to the intended purpose, all requirements with respect to the occurring of electrical, mechanical, thermic and corrosive stress will be satisfied.

P=5.08 RASTER PITCH

	METRIC TOLERANCES	70327/5 22.05.13 HELIS_MA 01		CAT. NO.: .	
	X. = ±0.3 X.X = ±0.1 X.XX = ±0.05	MODIFICATION			
	DRAWN	DATE	NAME	DRAWING NO. C 21277 18	
	RESPONSIBLE	27.08.2003	#AttributeError: Benutzer None nicht gegeben	SHEET 01 OF 01 SHEETS	
	CHECKED	27.05.2013	HECKERT_M	ISSUE NO.	
SCALE: 2/1 SUPERSEDES: .	APPROVED	HECKERT_M	PRODUCT FILE: SLS 5.08		7314

WEIDMÜLLER INTERFACE GmbH & Co. KG
 WEITERGABE SOWIE VERVIELFÄLTIGUNG DIESES DOKUMENTS, VERWERTUNG UND MITTEILUNG SEINES INHALTS SIND VERBOTEN, SOWEIT NICHT AUSDRUECKLICH GESTATTET.
 ZUWIDERHANDLUNGEN VERPFLICHTEN ZU SCHADENERSATZ. ALLE RECHTE FUER DEN FALL DER PATENT-, GEBRAUCHSMUSTER-, ODER GESCHMACKSMUSTERREINTRAGUNG VORBEHALTEN.
 THE REPRODUCTION, DISTRIBUTION AND UTILIZATION OF THIS DOCUMENT AS WELL AS THE COMMUNICATION OF ITS CONTENTS TO OTHERS WITHOUT EXPLICIT AUTHORIZATION IS PROHIBITED.
 OFFENDERS WILL BE HELD LIABLE FOR THE PAYMENT OF DAMAGES. WEIDMÜLLER EXCLUSIVELY RESERVES THE RIGHT TO FILE FOR PATENTS, UTILITY MODELS OR DESIGNS.