

## OMNIMATE Signal - series BL/SL 5.08 SLT 5.08/04/180B SN OR BX

**Weidmüller Interface GmbH & Co. KG**  
Klingenbergstraße 26  
D-32758 Detmold  
Germany  
Fon: +49 5231 14-0  
Fax: +49 5231 14-292083  
www.weidmueller.com

### Product image

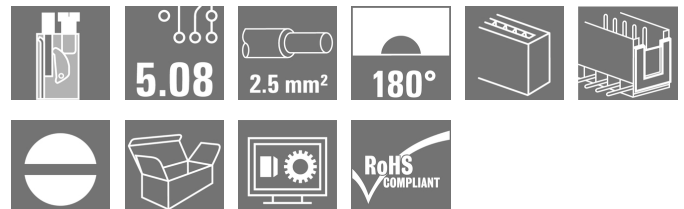

Similar to illustration

Male plugs with screw TOP wire connection. The male plug provides space for labelling and can be coded.

### General ordering data

Type	SLT 5.08/04/180B SN OR BX
Order No.	<a href="#">1611730000</a>
Version	PCB plug-in connector, male plug, 5.08 mm, Number of poles: 4, 180°, TOP connection, Clamping range, max. : 2.5 mm <sup>2</sup> , Box
GTIN (EAN)	4008190192617
Qty.	100 pc(s).
Product data	IEC: 400 V / 16 A / 0.2 - 2.5 mm <sup>2</sup> UL: 300 V / 15 A / AWG 26 - AWG 14
Packaging	Box

Creation date May 3, 2020 9:38:27 PM CEST

**OMNIMATE Signal - series BL/SL 5.08  
SLT 5.08/04/180B SN OR BX**

**Weidmüller Interface GmbH & Co. KG**  
Klingenbergstraße 26  
D-32758 Detmold  
Germany  
Fon: +49 5231 14-0  
Fax: +49 5231 14-292083  
www.weidmueller.com

**Technical data****Dimensions and weights**

Height	12.2 mm	Height (inches)	0.48 inch
Depth	34.1 mm	Depth (inches)	1.343 inch
Net weight	11.049 g		

**System Parameters**

Product family	OMNIMATE Signal - series BL/SL 5.08	Type of connection	Field connection
Wire connection method	TOP connection	Pitch in mm (P)	5.08 mm
Pitch in inches (P)	0.2 inch	Conductor outlet direction	180°
Number of poles	4	L1 in mm	15.24 mm
L1 in inches	0.6 inch	Number of rows	1
Pin series quantity	1	Touch-safe protection acc. to DIN VDE 57 106	finger-safe plugged/ back-of-hand-safe unplugged
Volume resistance	≤ 5mΩ	Can be coded	Yes
Stripping length	13 mm	Tightening torque, min.	0.4 Nm
Tightening torque, max.	0.5 Nm	Clamping screw	M 2.5
Screwdriver blade	0.6 x 3.5	Screwdriver blade standard	DIN 5264
Plugging cycles	25	Plugging force/pole, max.	5.5 N
Pulling force/pole, max.	5 N		

**Material data**

Insulating material	PBT	Colour	orange
Colour chart (similar)	RAL 2000	Insulating material group	IIIa
Comparative Tracking Index (CTI)	≥ 200	Insulation strength	≥ 10 <sup>8</sup> Ω
UL 94 flammability rating	V-0	GWFI	960 °C
Contact material	CuSn	Contact surface	tinned
Layer structure of plug contact	4-8 μm Sn hot-dip tinned	Storage temperature, min.	-25 °C
Storage temperature, max.	50 °C	Max. relative humidity during storage	70 %
Operating temperature, min.	-50 °C	Operating temperature, max.	100 °C
Temperature range, installation, min.	-25 °C	Temperature range, installation, max.	100 °C

**Conductors suitable for connection**

Clamping range, min.	0.13 mm <sup>2</sup>
Clamping range, max.	2.5 mm <sup>2</sup>
Wire connection cross section AWG, min.	AWG 26
Wire connection cross section AWG, max.	AWG 14
Solid, min. H05(07) V-U	0.2 mm <sup>2</sup>
Solid, max. H05(07) V-U	2.5 mm <sup>2</sup>
Flexible, min. H05(07) V-K	0.2 mm <sup>2</sup>
Flexible, max. H05(07) V-K	1.5 mm <sup>2</sup>
w. plastic collar ferrule, DIN 46228 pt 4, 0.2 mm <sup>2</sup> min.	
w. plastic collar ferrule, DIN 46228 pt 4, 1.5 mm <sup>2</sup> max.	
w. wire end ferrule, DIN 46228 pt 1, min.	0.2 mm <sup>2</sup>
w. wire end ferrule, DIN 46228 pt 1, max.	1.5 mm <sup>2</sup>
Plug gauge in accordance with EN 60999 a x b; ø	2.4 mm x 1.5 mm ; 2.4 mm

Creation date May 3, 2020 9:38:27 PM CEST

Catalogue status 17.04.2020 / We reserve the right to make technical changes.

**OMNIMATE Signal - series BL/SL 5.08  
SLT 5.08/04/180B SN OR BX**

**Weidmüller Interface GmbH & Co. KG**  
Klingenbergstraße 26  
D-32758 Detmold  
Germany  
Fon: +49 5231 14-0  
Fax: +49 5231 14-292083  
www.weidmueller.com

**Technical data**

Clampable conductor	Cross-section for conductor connection	Type	fine-wired
		nominal	0.5 mm <sup>2</sup>
wire end ferrule		Stripping length	nominal 14 mm
		Recommended wire-end ferrule	<a href="#">H0.5/18 OR</a>
Cross-section for conductor connection	Cross-section for conductor connection	Type	fine-wired
		nominal	1 mm <sup>2</sup>
wire end ferrule		Stripping length	nominal 15 mm
		Recommended wire-end ferrule	<a href="#">H1.0/18 GE</a>
Cross-section for conductor connection	Cross-section for conductor connection	Type	fine-wired
		nominal	1.5 mm <sup>2</sup>
wire end ferrule		Stripping length	nominal 15 mm
		Recommended wire-end ferrule	<a href="#">H1.5/18D SW</a>
Cross-section for conductor connection	Cross-section for conductor connection	Type	fine-wired
		nominal	0.75 mm <sup>2</sup>
wire end ferrule		Stripping length	nominal 14 mm
		Recommended wire-end ferrule	<a href="#">H0.75/18 W</a>

Reference text The outside diameter of the plastic collar should not be larger than the pitch (P), Length of ferrules is to be chosen depending on the product and the rated voltage.

Max. clamping range 2.5 mm<sup>2</sup>

**Rated data acc. to IEC**

tested acc. to standard	IEC 60664-1, IEC 61984	Rated current, min. number of poles (Tu=20°C)	16 A
Rated current, max. number of poles (Tu=20°C)	12.5 A	Rated current, min. number of poles (Tu=40°C)	13 A
Rated current, max. number of poles (Tu=40°C)	11 A	Rated voltage for surge voltage class / pollution degree II/2	400 V
Rated voltage for surge voltage class / pollution degree III/2	400 V	Rated voltage for surge voltage class / pollution degree III/3	250 V
Rated impulse voltage for surge voltage class/ pollution degree II/2	4 kV	Rated impulse voltage for surge voltage class/ pollution degree III/2	4 kV
Rated impulse voltage for surge voltage class/ contamination degree III/3	4 kV	Short-time withstand current resistance	3 x 1s with 120 A

**Rated data acc. to CSA**

Institute (CSA)		Certificate No. (CSA)	200039-1121690
Rated voltage (Use group B / CSA)	300 V	Rated voltage (Use group D / CSA)	300 V
Rated current (Use group B / CSA)	10 A	Rated current (Use group D / CSA)	10 A
Wire cross-section, AWG, min.	AWG 26	Wire cross-section, AWG, max.	AWG 14
Reference to approval values	Specifications are maximum values, details - see approval certificate.		

# Data sheet

## OMNIMATE Signal - series BL/SL 5.08 SLT 5.08/04/180B SN OR BX

**Weidmüller Interface GmbH & Co. KG**  
 Klingenbergstraße 26  
 D-32758 Detmold  
 Germany  
 Fon: +49 5231 14-0  
 Fax: +49 5231 14-292083  
 www.weidmueller.com

# Technical data

### Rated data acc. to UL 1059

Institute (UR)		Certificate No. (UR)	E60693
Rated voltage (Use group B / UL 1059)	300 V	Rated voltage (Use group D / UL 1059)	300 V
Rated current (Use group B / UL 1059)	15 A	Rated current (Use group D / UL 1059)	10 A
Wire cross-section, AWG, min.	AWG 26	Wire cross-section, AWG, max.	AWG 14
Reference to approval values	Specifications are maximum values, details - see approval certificate.		

### Packing

Packaging	Box	VPE length	38 mm
VPE width	149 mm	VPE height	243 mm

### Classifications

ETIM 6.0	EC002638	ETIM 7.0	EC002638
eClass 9.0	27-44-03-09	eClass 9.1	27-44-03-09
eClass 10.0	27-44-03-09	UNSPSC	30-21-18-10

### Notes

Notes	<ul style="list-style-type: none"> <li>• Additional colours on request</li> <li>• Rated current related to rated cross-section &amp; min. No. of poles.</li> <li>• Wire end ferrule without plastic collar to DIN 46228/1</li> <li>• Wire end ferrule with plastic collar to DIN 46228/4</li> <li>• Crimp form A for wire end ferrules with PZ 6/5 crimping tool are recommended for the largest cable sizes.</li> <li>• P on drawing = pitch</li> <li>• Rated data refer only to the component itself. Clearance and creepage distances to other components are to be designed in accordance with the relevant application standards.</li> </ul>
IPC conformity	Conformity: The products are developed, manufactured and delivered according international recognized standards and norms and comply with the assured properties in the data sheet resp. fulfill decorative properties in accordance with IPC-A-610 "Class 2". Further claims on the products can be evaluated on request.

### Approvals

Approvals	
ROHS	Conform

**Data sheet****OMNIMATE Signal - series BL/SL 5.08  
SLT 5.08/04/180B SN OR BX**

**Weidmüller Interface GmbH & Co. KG**  
Klingenbergstraße 26  
D-32758 Detmold  
Germany  
Fon: +49 5231 14-0  
Fax: +49 5231 14-292083  
www.weidmueller.com

**Technical data****Downloads**

Approval/Certificate/Document of Conformity	<a href="#">Declaration of the Manufacturer</a>
Brochure/Catalogue	<a href="#">FL DRIVES EN</a> <a href="#">MB DEVICE MANUF. EN</a> <a href="#">FL DRIVES DE</a> <a href="#">CAT 2 PORTFOLIOGUIDE EN</a> <a href="#">FL BUILDING SAFETY EN</a> <a href="#">FL APPL LED LIGHTING EN</a> <a href="#">FL INDUSTR.CONTROLS EN</a> <a href="#">FL MACHINE SAFETY EN</a> <a href="#">FL HEATING ELECTR EN</a> <a href="#">FL APPL INVERTER EN</a> <a href="#">FL BASE STATION EN</a> <a href="#">FL ELEVATOR EN</a> <a href="#">FL POWER SUPPLY EN</a> <a href="#">FL 72H SAMPLE SER EN</a> <a href="#">PO OMNIMATE EN</a>
Engineering Data	<a href="#">WSCAD</a>
Engineering Data	<a href="#">STEP</a>

**Data sheet**

**OMNIMATE Signal - series BL/SL 5.08  
SLT 5.08/04/180B SN OR BX**

**Weidmüller Interface GmbH & Co. KG**  
Klingenbergstraße 26  
D-32758 Detmold  
Germany  
Fon: +49 5231 14-0  
Fax: +49 5231 14-292083  
www.weidmueller.com

**Drawings**

**Dimensional drawing**

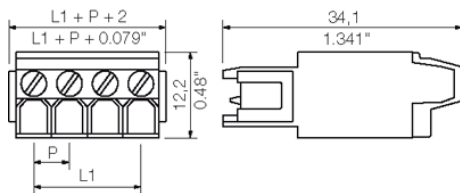

**Graph**

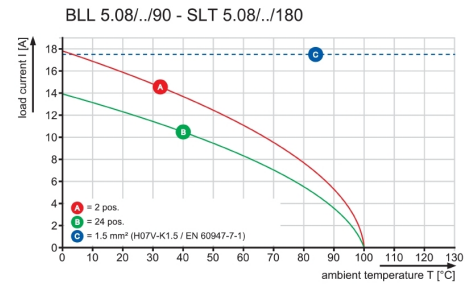

**Product benefits**



Lower assembly costs  
Secure in a matter of seconds

**Product benefits**

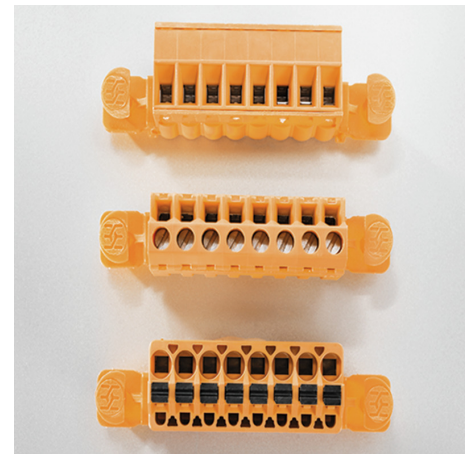

Flexible application options  
For 3 connection systems

**OMNIMATE Signal - series BL/SL 5.08  
SLT 5.08/04/180B SN OR BX**

**Weidmüller Interface GmbH & Co. KG**  
Klingenbergstraße 26  
D-32758 Detmold  
Germany  
Fon: +49 5231 14-0  
Fax: +49 5231 14-292083  
www.weidmueller.com

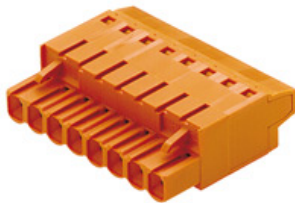
**Mating connector (conditionally pluggable)**
**BLT 5.08HC**

Female plugs with TOP screw connection system for connecting wires with straight 180° outlet direction. The female connectors provide space for labelling and can be coded. HC = High Current.

**General ordering data**

Type	BLT 5.08HC/04/180 SN BL ...	Version	Product data	Packaging
Order No.	<a href="#">1499780000</a>	PCB plug-in connector, female plug, 5.08 mm, Number of poles: 4,	IEC: 400 V / 27 A / 0.2 - 2.5 mm <sup>2</sup>	Box
GTIN (EAN)	4032248015467	180°, TOP connection, Clamping range, max. : 2.5 mm <sup>2</sup> , Box	UL: 300 V / 17 A / AWG 26 - AWG 14	
Qty.	90 pc(s).			

**BLZ 5.08/180**

Female plugs with clamping-yoke screw for wire connection with straight (180°) outlet direction. The female plugs provide space for labelling and can be coded.

**General ordering data**

Type	BLZ 5.08/04/180 SN OR B ...	Version	Product data	Packaging
Order No.	<a href="#">1594260000</a>	PCB plug-in connector, female plug, 5.08 mm, Number of poles: 4,	IEC: 400 V / 19 A / 0.2 - 2.5 mm <sup>2</sup>	Box
GTIN (EAN)	4008190001537	180°, Clamping yoke connection, Clamping range, max. : 3.31 mm <sup>2</sup> ,	UL: 300 V / 15 A / AWG 26 - AWG 12	
Qty.	90 pc(s).	Box		
Type	BLZ 5.08/04/180 SN DKG ...	Version	Product data	Packaging
Order No.	<a href="#">1526650000</a>	PCB plug-in connector, female plug, 5.08 mm, Number of poles: 4,	IEC: 400 V / 19 A / 0.2 - 2.5 mm <sup>2</sup>	Box
GTIN (EAN)	4008190069056	180°, Clamping yoke connection, Clamping range, max. : 3.31 mm <sup>2</sup> ,	UL: 300 V / 15 A / AWG 26 - AWG 12	
Qty.	100 pc(s).	Box		
Type	BLZ 5.08/04/180 SN GY BX	Version	Product data	Packaging
Order No.	<a href="#">1526600000</a>	PCB plug-in connector, female plug, 5.08 mm, Number of poles: 4,	IEC: 400 V / 19 A / 0.2 - 2.5 mm <sup>2</sup>	Box
GTIN (EAN)	4008190287115	180°, Clamping yoke connection, Clamping range, max. : 3.31 mm <sup>2</sup> ,	UL: 300 V / 15 A / AWG 26 - AWG 12	
Qty.	100 pc(s).	Box		

**OMNIMATE Signal - series BL/SL 5.08  
SLT 5.08/04/180B SN OR BX**

**Weidmüller Interface GmbH & Co. KG**  
Klingenbergstraße 26  
D-32758 Detmold  
Germany  
Fon: +49 5231 14-0  
Fax: +49 5231 14-292083  
www.weidmueller.com

**Mating connector (conditionally pluggable)**
**BLZ 5.08/90**

Female plugs with clamping-yoke screw connection. The female plugs provide space for labelling and can be coded.

**General ordering data**

Type	BLZ 5.08/04/90 SN GY BX	Version	Product data	Packaging
Order No.	<a href="#">1552900000</a>	PCB plug-in connector, female plug, 5.08 mm, Number of poles: 4,	IEC: 400 V / 15 A / 0.2 - 2.5 mm <sup>2</sup>	Box
GTIN (EAN)	4008190401566	90°, Clamping yoke connection, Clamping range, max. : 3.31 mm <sup>2</sup> ,	UL: 300 V / 10 A / AWG 26 - AWG 12	
Qty.	90 pc(s).	Box		

**BLL 5.08/180**

Female header for PCB mounting. The solder pin length is optimised for wave flow soldering.

**General ordering data**

Type	BLL 5.08/04/180 3.2 SN ...	Version	Product data	Packaging
Order No.	<a href="#">1687580000</a>	PCB plug-in connector, female header, closed side, THT solder	IEC: 400 V / 23 A	Box
GTIN (EAN)	4008190853662	connection, 5.08 mm, Number of poles: 4, 180°, Solder pin length (l):	UL: 300 V / 15 A	
Qty.	90 pc(s).	3.2 mm, tinned, Pebble grey, Box		
Type	BLL 5.08/04/180 4.5SN B ...	Version	Product data	Packaging
Order No.	<a href="#">1646270000</a>	PCB plug-in connector, female header, closed side, THT solder	IEC: 400 V / 23 A	Box
GTIN (EAN)	4008190285616	connection, 5.08 mm, Number of poles: 4, 180°, Solder pin length (l):	UL: 300 V / 15 A	
Qty.	100 pc(s).	4.5 mm, tinned, black, Box		
Type	BLL 5.08/04/180 4.5 SN ...	Version	Product data	Packaging
Order No.	<a href="#">1646160000</a>	PCB plug-in connector, female header, closed side, THT solder	IEC: 400 V / 23 A	Box
GTIN (EAN)	4008190285500	connection, 5.08 mm, Number of poles: 4, 180°, Solder pin length (l):	UL: 300 V / 15 A	
Qty.	90 pc(s).	4.5 mm, tinned, orange, Box		



**OMNIMATE Signal - series BL/SL 5.08  
SLT 5.08/04/180B SN OR BX**

**Weidmüller Interface GmbH & Co. KG**  
Klingenbergstraße 26  
D-32758 Detmold  
Germany  
Fon: +49 5231 14-0  
Fax: +49 5231 14-292083  
www.weidmueller.com

**Mating connector (conditionally pluggable)**
**BLL 5.08/90**

Female header for PCB mounting. The solder pin length is optimised for wave flow soldering.

**General ordering data**

Type	Version	Product data	Packaging
BLL 5.08/04/90 4.5 SN B ...	PCB plug-in connector, female header, closed side, THT solder connection, 5.08 mm, Number of poles: 4, 90°, Solder pin length (l): 4.5 mm, tinned, black, Box	IEC: 400 V / 23 A UL: 300 V / 15 A	Box
Order No. <a href="#">1646050000</a>			
GTIN (EAN) 4008190285395			
Qty. 90 pc(s).			

**BLZF 5.08/180**

Female plugs with tension-clamp wire connection system, straight 180° outlet direction. The female plugs provide space for labelling and can be coded.

**General ordering data**

Type	Version	Product data	Packaging
BLZF 5.08/04/180 SN DKG ...	PCB plug-in connector, female plug, 5.08 mm, Number of poles: 4, 180°, Tension-clamp connection, Clamping range, max.: 3.31 mm², UL: 300 V / 15 A / AWG 26 - AWG 12	IEC: 400 V / 17 A / 0.2 - 2.5 mm² UL: 300 V / 15 A / AWG 26 - AWG 12	Box
Order No. <a href="#">1707940000</a>			
GTIN (EAN) 4008190317355			
Qty. 90 pc(s).			

**OMNIMATE Signal - series BL/SL 5.08  
SLT 5.08/04/180B SN OR BX**

**Weidmüller Interface GmbH & Co. KG**  
Klingenbergstraße 26  
D-32758 Detmold  
Germany  
Fon: +49 5231 14-0  
Fax: +49 5231 14-292083  
www.weidmueller.com

**Mating connector (fully pluggable)**
**BLZP 5.08HC/225 SN**

Clamping-yoke connection with right-angled (90° or 270°) or angled (225°) outlet direction. The female connectors provide space for labelling and can be coded. Fastened by means of a flange or release latch. They also provide an integrated plus/minus screw, protection against faulty insertion of the wire, and they are delivered with open clamping yokes. HC = High Current.

**General ordering data**

Type	BLZP 5.08HC/04/225 SN O ...	Version	Product data	Packaging
Order No.	<a href="#">1946270000</a>	PCB plug-in connector, female plug, 5.08 mm, Number of poles: 4,	IEC: 400 V / 17.5 A / 0.2 - 4 mm <sup>2</sup>	Box
GTIN (EAN)	4032248621842	225°, Clamping yoke connection, Clamping range, max. : 4 mm <sup>2</sup> , Box	UL: 300 V / 15 A / AWG 26 - AWG 12	
Qty.	90 pc(s).			
Type	BLZP 5.08HC/04/225 SN B ...	Version	Product data	Packaging
Order No.	<a href="#">1946580000</a>	PCB plug-in connector, female plug, 5.08 mm, Number of poles: 4,	IEC: 400 V / 17.5 A / 0.2 - 4 mm <sup>2</sup>	Box
GTIN (EAN)	4032248622351	225°, Clamping yoke connection, Clamping range, max. : 4 mm <sup>2</sup> , Box	UL: 300 V / 15 A / AWG 26 - AWG 12	
Qty.	90 pc(s).			

**BLZP 5.08HC/270 SN**

Female plugs with clamping-yoke connection for connecting wires with a right-angle (90° or 270°) outlet direction. The female connectors provide space for labelling and can be coded. Fastened by means of a flange or release latch. They also provide an integrated plus/minus screw, protection against faulty insertion of the wire, and they are delivered with open clamping yokes. HC = High Current.

**General ordering data**

Type	BLZP 5.08HC/04/270 SN O ...	Version	Product data	Packaging
Order No.	<a href="#">1948810000</a>	PCB plug-in connector, female plug, 5.08 mm, Number of poles: 4,	IEC: 400 V / 23 A / 0.2 - 4 mm <sup>2</sup>	Box
GTIN (EAN)	4032248626267	270°, Clamping yoke connection, Clamping range, max. : 4 mm <sup>2</sup> , Box	UL: 300 V / 20 A / AWG 26 - AWG 12	
Qty.	90 pc(s).			

**OMNIMATE Signal - series BL/SL 5.08  
SLT 5.08/04/180B SN OR BX**

**Weidmüller Interface GmbH & Co. KG**  
Klingenbergstraße 26  
D-32758 Detmold  
Germany  
Fon: +49 5231 14-0  
Fax: +49 5231 14-292083  
www.weidmueller.com

**Mating connector (fully pluggable)**
**BLF 5.08HC/180DF SN**

Just as reliable as the millionfold proven original and featuring innovative details:  
The BLF 5.08HC PUSH IN version of the BLZP 5.08HC female connector is not only different in terms of connection system; it also has a more compact design. Weidmüller's innovative PUSH IN spring connection system stands for the future of easy and tool-free wire connection. HC = High Current.  
In terms of versatility, the BLF 5.08HC offers just as much as the version which served as a model:

- 3 tested-and-proven wire outlet directions provide the usual flexibility for application-specific design
- 4 flange variations and the patented release latch allow the locking concept to be based on the requirements of the user
- Use the BLF 5.08HC and SL 5.08HC plug combination to reach the max. rated specifications

**General ordering data**

Type	BLF 5.08HC/04/180DF SN ...	Version	Product data	Packaging
Order No.	<a href="#">1353270000</a>	PCB plug-in connector, female plug, 5.08 mm, Number of poles: 4,	IEC: 400 V / 24 A / 0.2 - 2.5 mm <sup>2</sup>	Box
GTIN (EAN)	4050118155785	180°, PUSH IN, Spring connection, Clamping range, max. : 3.31 mm <sup>2</sup> , UL: 300 V / 18.5 A / AWG 26 - AWG		
Qty.	42 pc(s).	Box	12	

**BLZP 5.08HC/180 SN**

Female plug with clamping-yoke screw system for connecting wires with straight (180°) outlet direction. The female connectors provide space for labelling and can be coded. Fastened by means of a flange or release latch. They also provide an integrated plus/minus screw, protection against faulty insertion of the wire, and they are delivered with open clamping yokes. HC = High Current.

**General ordering data**

Type	BLZP 5.08HC/04/180 SN O ...	Version	Product data	Packaging
Order No.	<a href="#">1943600000</a>	PCB plug-in connector, female plug, 5.08 mm, Number of poles: 4,	IEC: 400 V / 23 A / 0.2 - 4 mm <sup>2</sup>	Box
GTIN (EAN)	4032248617593	180°, Clamping yoke connection, Clamping range, max. : 4 mm <sup>2</sup> , Box	UL: 300 V / 20 A / AWG 26 - AWG 12	
Qty.	90 pc(s).			
Type	BLZP 5.08HC/04/180 SN B ...	Version	Product data	Packaging
Order No.	<a href="#">1943830000</a>	PCB plug-in connector, female plug, 5.08 mm, Number of poles: 4,	IEC: 400 V / 23 A / 0.2 - 4 mm <sup>2</sup>	Box
GTIN (EAN)	4032248617869	180°, Clamping yoke connection, Clamping range, max. : 4 mm <sup>2</sup> , Box	UL: 300 V / 20 A / AWG 26 - AWG 12	
Qty.	90 pc(s).			

**OMNIMATE Signal - series BL/SL 5.08  
SLT 5.08/04/180B SN OR BX**

**Weidmüller Interface GmbH & Co. KG**  
Klingenbergstraße 26  
D-32758 Detmold  
Germany  
Fon: +49 5231 14-0  
Fax: +49 5231 14-292083  
www.weidmuller.com

**Mating connector (fully pluggable)****BLF 5.08HC/180 SN**

Just as reliable as the millionfold proven original and featuring innovative details:

The BLF 5.08HC PUSH IN version of the BLZP 5.08HC female connector is not only different in terms of connection system; it also has a more compact design. Weidmüller's innovative PUSH IN spring connection system stands for the future of easy and tool-free wire connection. HC = High Current.

In terms of versatility, the BLF 5.08HC offers just as much as the version which served as a model:

- 3 tested-and-proven wire outlet directions provide the usual flexibility for application-specific design
- 4 flange variations and the patented release latch allow the locking concept to be based on the requirements of the user
- Use the BLF 5.08HC and SL 5.08HC plug combination to reach the max. rated specifications

**General ordering data**

Type	BLF 5.08HC/04/180 SN OR ...	Version	Product data	Packaging
Order No.	<a href="#">1013710000</a>	PCB plug-in connector, female plug, 5.08 mm, Number of poles: 4,	IEC: 400 V / 24 A / 0.2 - 2.5 mm <sup>2</sup>	Box
GTIN (EAN)	4032248721825	180°, PUSH IN, Spring connection, Clamping range, max. : 3.31 mm <sup>2</sup> , UL: 300 V / 18.5 A / AWG 26 - AWG		
Qty.	90 pc(s).	Box	12	
Type	BLF 5.08HC/04/180 SN BK ...	Version	Product data	Packaging
Order No.	<a href="#">1013450000</a>	PCB plug-in connector, female plug, 5.08 mm, Number of poles: 4,	IEC: 400 V / 24 A / 0.2 - 2.5 mm <sup>2</sup>	Box
GTIN (EAN)	4032248721603	180°, PUSH IN, Spring connection, Clamping range, max. : 3.31 mm <sup>2</sup> , UL: 300 V / 18.5 A / AWG 26 - AWG		
Qty.	90 pc(s).	Box	12	

**BLZP 5.08HC/90 SN**

Female plugs with clamping-yoke connection for connecting wires with a right-angle (90° or 270°) outlet direction. The female connectors provide space for labelling and can be coded. Fastened by means of a flange or release latch. They also provide an integrated plus/minus screw, protection against faulty insertion of the wire, and they are delivered with open clamping yokes. HC = High Current.

**General ordering data**

Type	BLZP 5.08HC/04/90 SN OR ...	Version	Product data	Packaging
Order No.	<a href="#">1948020000</a>	PCB plug-in connector, female plug, 5.08 mm, Number of poles: 4,	IEC: 400 V / 23 A / 0.2 - 4 mm <sup>2</sup>	Box
GTIN (EAN)	4032248624249	90°, Clamping yoke connection, Clamping range, max. : 4 mm <sup>2</sup> , Box	UL: 300 V / 20 A / AWG 26 - AWG 12	
Qty.	90 pc(s).			
Type	BLZP 5.08HC/04/90 SN BK ...	Version	Product data	Packaging
Order No.	<a href="#">1948260000</a>	PCB plug-in connector, female plug, 5.08 mm, Number of poles: 4,	IEC: 400 V / 23 A / 0.2 - 4 mm <sup>2</sup>	Box
GTIN (EAN)	4032248624782	90°, Clamping yoke connection, Clamping range, max. : 4 mm <sup>2</sup> , Box	UL: 300 V / 20 A / AWG 26 - AWG 12	
Qty.	90 pc(s).			

**OMNIMATE Signal - series BL/SL 5.08  
SLT 5.08/04/180B SN OR BX**

**Weidmüller Interface GmbH & Co. KG**  
Klingenbergstraße 26  
D-32758 Detmold  
Germany  
Fon: +49 5231 14-0  
Fax: +49 5231 14-292083  
www.weidmueller.com

**Mating connector (fully pluggable)**
**BLC 5.08R**

Female plugs with crimp wire connection system. The female plugs provide space for labelling and can be coded.

**General ordering data**

Type	BLC 5.08/04/180R OR BX	Version	Product data	Packaging
Order No.	<a href="#">1610510000</a>	PCB plug-in connector, female plug, 5.08 mm, Number of poles: 4,	IEC: 400 V / 21 A	Box
GTIN (EAN)	4008190065102	180°, Crimp connection, Clamping range, max. : 2.5 mm <sup>2</sup> , Box	UL: 300 V / 10 A / AWG 26 - AWG 14	
Qty.	100 pc(s).			
Type	BLC 5.08/04/180R BK BX	Version	Product data	Packaging
Order No.	<a href="#">1711980000</a>	PCB plug-in connector, female plug, 5.08 mm, Number of poles: 4,	IEC: 400 V / 21 A	Box
GTIN (EAN)	4008190934996	180°, Crimp connection, Clamping range, max. : 2.5 mm <sup>2</sup> , Box	UL: 300 V / 10 A / AWG 26 - AWG 14	
Qty.	100 pc(s).			

**BLF 5.08HC/90 SN**

Just as reliable as the millionfold proven original and featuring innovative details:  
The BLF 5.08HC PUSH IN version of the BLZP 5.08HC female connector is not only different in terms of connection system; it also has a more compact design. Weidmüller's innovative PUSH IN spring connection system stands for the future of easy and tool-free wire connection. HC = High Current.  
In terms of versatility, the BLF 5.08HC offers just as much as the version which served as a model:

- 3 tested-and-proven wire outlet directions provide the usual flexibility for application-specific design
- 4 flange variations and the patented release latch allow the locking concept to be based on the requirements of the user
- Use the BLF 5.08HC and SL 5.08HC plug combination to reach the max. rated specifications

**General ordering data**

Type	BLF 5.08HC/04/90 SN BK ...	Version	Product data	Packaging
Order No.	<a href="#">1000050001</a>	PCB plug-in connector, female plug, 5.08 mm, Number of poles: 4,	IEC: 400 V / 24 A / 0.2 - 2.5 mm <sup>2</sup>	Box
GTIN (EAN)	4032248689989	90°, PUSH IN, Spring connection, Clamping range, max. : 3.31 mm <sup>2</sup> ,	UL: 300 V / 18.5 A / AWG 26 - AWG 12	
Qty.	90 pc(s).	Box		
Type	BLF 5.08HC/04/90 SN OR ...	Version	Product data	Packaging
Order No.	<a href="#">1001550000</a>	PCB plug-in connector, female plug, 5.08 mm, Number of poles: 4,	IEC: 400 V / 24 A / 0.2 - 2.5 mm <sup>2</sup>	Box
GTIN (EAN)	4032248693351	90°, PUSH IN, Spring connection, Clamping range, max. : 3.31 mm <sup>2</sup> ,	UL: 300 V / 18.5 A / AWG 26 - AWG 12	
Qty.	90 pc(s).	Box		

**OMNIMATE Signal - series BL/SL 5.08  
SLT 5.08/04/180B SN OR BX**

**Weidmüller Interface GmbH & Co. KG**  
Klingenbergstraße 26  
D-32758 Detmold  
Germany  
Fon: +49 5231 14-0  
Fax: +49 5231 14-292083  
www.weidmueller.com

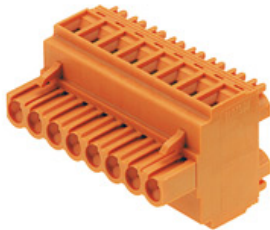
**Mating connector (fully pluggable)**
**BLDT 5.08**

Female plugs with two clamping-yoke screw connections per pole for wire connections with 90° and 270° outlet directions. The female plugs provide space for labelling and can be coded.

**General ordering data**

Type	BLDT 5.08/04/- SN BK BX	Version	Product data	Packaging
Order No.	<a href="#">1660730000</a>	PCB plug-in connector, female plug, 5.08 mm, Number of poles: 4,	IEC: 400 V / 14 A / 0.2 - 2.5 mm <sup>2</sup>	Box
GTIN (EAN)	4008190417185	180°, Clamping yoke connection, Clamping range, max. : 3.31 mm <sup>2</sup> ,	UL: 300 V / 10 A / AWG 26 - AWG 12	
Qty.	75 pc(s).	Box		
Type	BLDT 5.08/04/- SN OR BX	Version	Product data	Packaging
Order No.	<a href="#">1644750000</a>	PCB plug-in connector, female plug, 5.08 mm, Number of poles: 4,	IEC: 400 V / 14 A / 0.2 - 2.5 mm <sup>2</sup>	Box
GTIN (EAN)	4008190283964	180°, Clamping yoke connection, Clamping range, max. : 3.31 mm <sup>2</sup> ,	UL: 300 V / 10 A / AWG 26 - AWG 12	
Qty.	75 pc(s).	Box		

**BLF 5.08HC/270 SN**

Just as reliable as the millionfold proven original and featuring innovative details:  
The BLF 5.08HC PUSH IN version of the BLZP 5.08HC female connector is not only different in terms of connection system; it also has a more compact design. Weidmüller's innovative PUSH IN spring connection system stands for the future of easy and tool-free wire connection. HC = High Current.  
In terms of versatility, the BLF 5.08HC offers just as much as the version which served as a model:

- 3 tested-and-proven wire outlet directions provide the usual flexibility for application-specific design
- 4 flange variations and the patented release latch allow the locking concept to be based on the requirements of the user
- Use the BLF 5.08HC and SL 5.08HC plug combination to reach the max. rated specifications

**General ordering data**

Type	BLF 5.08HC/04/270 SN BK ...	Version	Product data	Packaging
Order No.	<a href="#">1981950000</a>	PCB plug-in connector, female plug, 5.08 mm, Number of poles: 4,	IEC: 400 V / 24 A / 0.2 - 2.5 mm <sup>2</sup>	Box
GTIN (EAN)	4032248684649	270°, PUSH IN, Spring connection, Clamping range, max. : 3.31 mm <sup>2</sup> ,	UL: 300 V / 18.5 A / AWG 26 - AWG 12	
Qty.	90 pc(s).	Box		
Type	BLF 5.08HC/04/270 SN OR ...	Version	Product data	Packaging
Order No.	<a href="#">1982720000</a>	PCB plug-in connector, female plug, 5.08 mm, Number of poles: 4,	IEC: 400 V / 24 A / 0.2 - 2.5 mm <sup>2</sup>	Box
GTIN (EAN)	4032248686810	270°, PUSH IN, Spring connection, Clamping range, max. : 3.31 mm <sup>2</sup> ,	UL: 300 V / 18.5 A / AWG 26 - AWG 12	
Qty.	90 pc(s).	Box		

**OMNIMATE Signal - series BL/SL 5.08  
SLT 5.08/04/180B SN OR BX**

**Weidmüller Interface GmbH & Co. KG**  
Klingenbergstraße 26  
D-32758 Detmold  
Germany  
Fon: +49 5231 14-0  
Fax: +49 5231 14-292083  
www.weidmueller.com

**Mating connector (fully pluggable)**
**BLZP 5.08HC/225B SN**

Clamping-yoke connection with right-angled (90° or 270°) or angled (225°) outlet direction. The female connectors provide space for labelling and can be coded. Fastened by means of a flange or release latch. They also provide an integrated plus/minus screw, protection against faulty insertion of the wire, and they are delivered with open clamping yokes. HC = High Current.

**General ordering data**

Type	BLZP 5.08HC/04/225B SN ...	Version	Product data	Packaging
Order No.	<a href="#">1946000000</a>	PCB plug-in connector, female plug, 5.08 mm, Number of poles: 4,	IEC: 400 V / 17.5 A / 0.2 - 4 mm <sup>2</sup>	Box
GTIN (EAN)	4032248621521	225°, Clamping yoke connection, Clamping range, max. : 4 mm <sup>2</sup> , Box	UL: 300 V / 15 A / AWG 26 - AWG 12	
Qty.	78 pc(s).			
Type	BLZP 5.08HC/04/225B SN ...	Version	Product data	Packaging
Order No.	<a href="#">1945770000</a>	PCB plug-in connector, female plug, 5.08 mm, Number of poles: 4,	IEC: 400 V / 17.5 A / 0.2 - 4 mm <sup>2</sup>	Box
GTIN (EAN)	4032248621248	225°, Clamping yoke connection, Clamping range, max. : 4 mm <sup>2</sup> , Box	UL: 300 V / 15 A / AWG 26 - AWG 12	
Qty.	78 pc(s).			

**BLL 5.08/180**

Female header for PCB mounting. The solder pin length is optimised for wave flow soldering.

**General ordering data**

Type	BLL 5.08/04/180 3.2 SN ...	Version	Product data	Packaging
Order No.	<a href="#">1630730000</a>	PCB plug-in connector, female header, closed side, THT solder	IEC: 400 V / 23 A	Box
GTIN (EAN)	4008190204150	connection, 5.08 mm, Number of poles: 4, 180°, Solder pin length (!):	UL: 300 V / 15 A	
Qty.	90 pc(s).	3.2 mm, tinned, orange, Box		



**OMNIMATE Signal - series BL/SL 5.08  
SLT 5.08/04/180B SN OR BX**

**Weidmüller Interface GmbH & Co. KG**  
Klingenbergstraße 26  
D-32758 Detmold  
Germany  
Fon: +49 5231 14-0  
Fax: +49 5231 14-292083  
www.weidmueller.com

**Mating connector (fully pluggable)**
**BLL 5.08/90**

Female header for PCB mounting. The solder pin length is optimised for wave flow soldering.

**General ordering data**

Type	BLL 5.08/04/90 3.2 SN O ...	Version	Product data	Packaging
Order No.	<a href="#">1622960000</a>	PCB plug-in connector, female header, closed side, THT solder connection, 5.08 mm, Number of poles: 4, 90°, Solder pin length (l): 3.2 mm, tinned, orange, Box	IEC: 400 V / 23 A UL: 300 V / 15 A	Box
GTIN (EAN)	4008190194024			
Qty.	90 pc(s).			

**BLDT 5.08B**

Female plugs with two clamping-yoke screw connections per pole for wire connections with 90° and 270° outlet directions. The female plugs provide space for labelling and can be coded.

**General ordering data**

Type	BLDT 5.08/04/-B SN OR BX	Version	Product data	Packaging
Order No.	<a href="#">1651760000</a>	PCB plug-in connector, female plug, 5.08 mm, Number of poles: 4, 180°, Clamping yoke connection, Clamping range, max. : 3.31 mm², Box	IEC: 400 V / 14 A / 0.2 - 2.5 mm² UL: 300 V / 10 A / AWG 26 - AWG 12	Box
GTIN (EAN)	4008190400446			
Qty.	70 pc(s).			
Type	BLDT 5.08/04/-B SN BK BX	Version	Product data	Packaging
Order No.	<a href="#">1673800000</a>	PCB plug-in connector, female plug, 5.08 mm, Number of poles: 4, 180°, Clamping yoke connection, Clamping range, max. : 3.31 mm², Box	IEC: 400 V / 14 A / 0.2 - 2.5 mm² UL: 300 V / 10 A / AWG 26 - AWG 12	Box
GTIN (EAN)	4008190435530			
Qty.	70 pc(s).			



**OMNIMATE Signal - series BL/SL 5.08  
SLT 5.08/04/180B SN OR BX**

**Weidmüller Interface GmbH & Co. KG**  
Klingenbergstraße 26  
D-32758 Detmold  
Germany  
Fon: +49 5231 14-0  
Fax: +49 5231 14-292083  
www.weidmueller.com

**Mating connector (fully pluggable)**
**BLDF 5.08/180 SN**

The powerful daisy-chain solution for high-performance signal bus applications is also suitable for 400V auxiliary power chains with 18.5A current-carrying capacity. The large clamping capacity (up to 2.5mm<sup>2</sup> wire cross-sections) is particularly beneficial for long bus cables or high currents because of the low voltage drop. Four flange variations, including the patented release latch, allow for user-friendly unplugging designs.

**General ordering data**

Type	BLDF 5.08/04/180 SN BK ...	Version	Product data	Packaging
Order No.	<a href="#">1000880000</a>	PCB plug-in connector, female plug, 5.08 mm, Number of poles: 4,	IEC: 400 V / 20.8 A / 0.2 - 2.5 mm <sup>2</sup>	Box
GTIN (EAN)	4032248817269	180°, PUSH IN, Spring connection, Clamping range, max. : 3.31 mm <sup>2</sup> ,	UL: 300 V / 18.5 A / AWG 12 - AWG	
Qty.	60 pc(s).	Box	26	
Type	BLDF 5.08/04/180 SN OR ...	Version	Product data	Packaging
Order No.	<a href="#">1001170000</a>	PCB plug-in connector, female plug, 5.08 mm, Number of poles: 4,	IEC: 400 V / 20.8 A / 0.2 - 2.5 mm <sup>2</sup>	Box
GTIN (EAN)	4032248818075	180°, PUSH IN, Spring connection, Clamping range, max. : 3.31 mm <sup>2</sup> ,	UL: 300 V / 18.5 A / AWG 12 - AWG	
Qty.	60 pc(s).	Box	26	

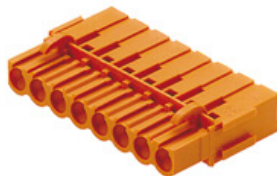
**BLC 5.08BR**

Female plugs with crimp wire connection system. The female plugs provide space for labelling and can be coded.

**General ordering data**

Type	BLC 5.08/04/180BR OR BX	Version	Product data	Packaging
Order No.	<a href="#">1649390000</a>	PCB plug-in connector, female plug, 5.08 mm, Number of poles: 4,	IEC: 400 V / 21 A	Box
GTIN (EAN)	4008190294502	180°, Crimp connection, Clamping range, max. : 2.5 mm <sup>2</sup> ,	UL: 300 V / 10 A / AWG 26 - AWG 14	
Qty.	100 pc(s).	Box		
Type	BLC 5.08/04/180BR BK BX	Version	Product data	Packaging
Order No.	<a href="#">1712130000</a>	PCB plug-in connector, female plug, 5.08 mm, Number of poles: 4,	IEC: 400 V / 21 A	Box
GTIN (EAN)	4008190935146	180°, Crimp connection, Clamping range, max. : 2.5 mm <sup>2</sup> ,	UL: 300 V / 10 A / AWG 26 - AWG 14	
Qty.	100 pc(s).			

**OMNIMATE Signal - series BL/SL 5.08  
SLT 5.08/04/180B SN OR BX**

**Weidmüller Interface GmbH & Co. KG**  
Klingenbergstraße 26  
D-32758 Detmold  
Germany  
Fon: +49 5231 14-0  
Fax: +49 5231 14-292083  
www.weidmueller.com

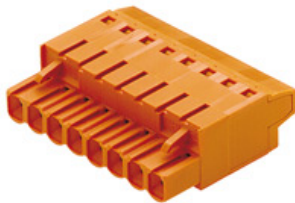
**Mating connector (fully pluggable)**
**BLT 5.08HC/180B**

Female plugs with TOP screw connection system for connecting wires with straight 180° outlet direction. The female connectors provide space for labelling and can be coded. HC = High Current.

**General ordering data**

Type	BLT 5.08HC/04/180B SN O ...	Version	Product data	Packaging
Order No.	<a href="#">1502060000</a>	PCB plug-in connector, female plug, 5.08 mm, Number of poles: 4,	IEC: 400 V / 27 A / 0.2 - 2.5 mm <sup>2</sup>	Box
GTIN (EAN)	4008190166441	180°, TOP connection, Clamping range, max. : 2.5 mm <sup>2</sup> , Box	UL: 300 V / 17 A / AWG 26 - AWG 14	
Qty.	78 pc(s).			

**BLL 5.08/180B**

Female header for PCB mounting. The solder pin length is optimised for wave flow soldering.

**General ordering data**

Type	BLL 5.08/04/180B 3.2SN ...	Version	Product data	Packaging
Order No.	<a href="#">1682750000</a>	PCB plug-in connector, female header, Dovetails for fixing blocks, THT	IEC: 400 V / 23 A	Box
GTIN (EAN)	4008190474515	solder connection, 5.08 mm, Number of poles: 4, 180°, Solder pin	UL: 300 V / 15 A	
Qty.	78 pc(s).	length (l): 3.2 mm, tinned, orange, Box		

## OMNIMATE Signal - series BL/SL 5.08 SLT 5.08/04/180B SN OR BX

**Weidmüller Interface GmbH & Co. KG**  
 Klingenbergstraße 26  
 D-32758 Detmold  
 Germany  
 Fon: +49 5231 14-0  
 Fax: +49 5231 14-292083  
 www.weidmueller.com

# Accessories

## Coding elements



**Only connects what is supposed to be connected: the right connection at the right place.**

Coding elements and locking devices clearly assign connecting elements during the manufacturing process and operation

The coding elements and locking devices are inserted prior to assembly or during the cable assembly phase. The Weidmüller alternative: configure online using the variant configurator to precode prior to delivery.

Incorrect assembly on the circuit board and incorrect plugging of connecting elements is no longer possible. The advantage: no troubleshooting during manufacture and no operational errors by the user.

### General ordering data

Type	BLZ/SL KO BK BX	Version	Product data	Packaging
Order No.	<a href="#">1545710000</a>	PCB plug-in connector, Accessories, Coding element, black, Number		Box
GTIN (EAN)	4008190087142	of poles: 1		
Qty.	50 pc(s).			
Type	BLZ/SL KO OR BX	Version	Product data	Packaging
Order No.	<a href="#">1573010000</a>	PCB plug-in connector, Accessories, Coding element, orange, Number		Box
GTIN (EAN)	4008190048396	of poles: 1		
Qty.	100 pc(s).			

## Additional accessories



**No task is too small when creating the perfect solution.** br />

Connections form just one part of the overall process. Small details are often the key to the perfect solution in applications where potentials are tested, grouped or even isolated.

A system is not a system without small but useful details:

- Test plugs - ensure reliable pick-up from diagnostic sockets
- Cross-connectors - ensure a stable electrical distribution contact directly at the connection
- Compartment partition elements - divide a large number of male connectors into several separate socket connector channels
- Locks and clips - optional vibration-resistant clip-on connection or mounting for male and female connectors

In tandem with the manufacturing process and application - more accessories = smaller workload

### General ordering data

Type	SL AT OR	Version	Product data	Packaging
Order No.	<a href="#">1598300000</a>	PCB plug-in connector, Accessories, Spacer, orange, Number of poles:		Box
GTIN (EAN)	4008190189266	1		
Qty.	100 pc(s).			

## OMNIMATE Signal - series BL/SL 5.08 SLT 5.08/04/180B SN OR BX

**Weidmüller Interface GmbH & Co. KG**  
 Klingenbergstraße 26  
 D-32758 Detmold  
 Germany  
 Fon: +49 5231 14-0  
 Fax: +49 5231 14-292083  
 www.weidmueller.com

## Accessories

Type	SL AT SW	Version	Product data	Packaging
Order No.	<a href="#">1770240000</a>	PCB plug-in connector, Accessories, Spacer, black, Number of poles: 1		Box
GTIN (EAN)	4032248117710			
Qty.	100 pc(s).			

## Blocks for PCB mounting



### Minor component, major effect:

Clip-on attachment elements increase the mechanical resilience of the whole plug connection by

- securing the male connectors to the circuit board
- providing a vibration-proof connection between the sockets and the male connectors

Clip-on or pre-assembled - always the right solution:

- Hard-wearing, precise fitting dovetail joint
- Hard-wearing metal threaded inserts
- Suitable for all outlet directions

Maximum stability, minimum effort:

- Extremely resilient for frequent fastening operations
- Complete set for easy selection

The result: soldering points, contacts and overall module are more resilient against mechanical stress such as vibrations and tensile loads.

## General ordering data

Type	SLA BB6R OR	Version	Product data	Packaging
Order No.	<a href="#">1723470000</a>	PCB plug-in connector, Accessories, Mounting block, orange, Number of poles: 1		Box
GTIN (EAN)	4008190366025			
Qty.	20 pc(s).			
Type	SLA BB6R SW	Version	Product data	Packaging
Order No.	<a href="#">1723520000</a>	PCB plug-in connector, Accessories, Mounting block, black, Number of poles: 1		Box
GTIN (EAN)	4008190366070			
Qty.	20 pc(s).			
Type	BBDF BK	Version	Product data	Packaging
Order No.	<a href="#">1307580000</a>	PCB plug-in connector, Accessories, Mounting block, black		Box
GTIN (EAN)	4050118109764			
Qty.	100 pc(s).			
Type	SLA BB11R SW	Version	Product data	Packaging
Order No.	<a href="#">1692340000</a>	PCB plug-in connector, Accessories, Mounting block, black, Number of poles: 1		Box
GTIN (EAN)	4008190864965			
Qty.	20 pc(s).			
Type	SLA BB1R OR	Version	Product data	Packaging
Order No.	<a href="#">1723430000</a>	PCB plug-in connector, Accessories, Mounting block, orange, Number of poles: 1		Box
GTIN (EAN)	4008190365981			
Qty.	20 pc(s).			
Type	SLA BB12R OR	Version	Product data	Packaging
Order No.	<a href="#">1593450000</a>	PCB plug-in connector, Accessories, Mounting block, orange, Number of poles: 1		Box
GTIN (EAN)	4008190122164			
Qty.	100 pc(s).			

**OMNIMATE Signal - series BL/SL 5.08  
SLT 5.08/04/180B SN OR BX**

**Weidmüller Interface GmbH & Co. KG**  
Klingenbergstraße 26  
D-32758 Detmold  
Germany  
Fon: +49 5231 14-0  
Fax: +49 5231 14-292083  
www.weidmueller.com

**Accessories**

Type	SLA BB5R OR	Version	Product data	Packaging
Order No.	<a href="#">1723460000</a>	PCB plug-in connector, Accessories, Mounting block, orange, Number		Box
GTIN (EAN)	4008190366018	of poles: 1		
Qty.	20 pc(s).			
Type	SLA BB11R OR	Version	Product data	Packaging
Order No.	<a href="#">1604120000</a>	PCB plug-in connector, Accessories, Mounting block, orange, Number		Box
GTIN (EAN)	4008190182977	of poles: 1		
Qty.	20 pc(s).			
Type	BBDF OR	Version	Product data	Packaging
Order No.	<a href="#">1307570000</a>	PCB plug-in connector, Accessories, Mounting block, orange		Box
GTIN (EAN)	4050118109566			
Qty.	100 pc(s).			
Type	SLA BB1R SW	Version	Product data	Packaging
Order No.	<a href="#">1723480000</a>	PCB plug-in connector, Accessories, Mounting block, black, Number of		Box
GTIN (EAN)	4008190366032	poles: 1		
Qty.	20 pc(s).			
Type	SLA BB5R SW	Version	Product data	Packaging
Order No.	<a href="#">1723510000</a>	PCB plug-in connector, Accessories, Mounting block, black, Number of		Box
GTIN (EAN)	4008190366063	poles: 1		
Qty.	20 pc(s).			
Type	SLA BB2R OR	Version	Product data	Packaging
Order No.	<a href="#">1723440000</a>	PCB plug-in connector, Accessories, Mounting block, orange, Number		Box
GTIN (EAN)	4008190365998	of poles: 1		
Qty.	20 pc(s).			
Type	SLA BB12R SW	Version	Product data	Packaging
Order No.	<a href="#">1626880000</a>	PCB plug-in connector, Accessories, Mounting block, black, Number of		Box
GTIN (EAN)	4008190198213	poles: 1		
Qty.	100 pc(s).			
Type	SLA BB2R SW	Version	Product data	Packaging
Order No.	<a href="#">1723490000</a>	PCB plug-in connector, Accessories, Mounting block, black, Number of		Box
GTIN (EAN)	4008190366049	poles: 1		
Qty.	20 pc(s).			

MASSE OHNE TOLERANZ SIND KEINE PRUEFMASSE  
 DIMS. WITHOUT TOLERANCE ARE NOT CONTROL DIMS.

ALLGEMEINGUELTIGE KUNDENZEICHNUNG, AKTUELLER STAND NUR AUF ANFRAGE  
 GENERAL CUSTOMER DRAWING, TOPICAL VERSION ONLY IF REQUIRED

DIE DEUTSCHE VERSION IST VERBINDLICH  
 THE GERMAN VERSION IS BINDING

SHOWN: SLT 5.08/04/180

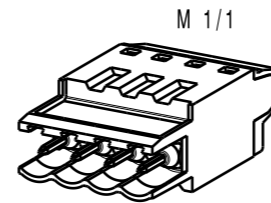
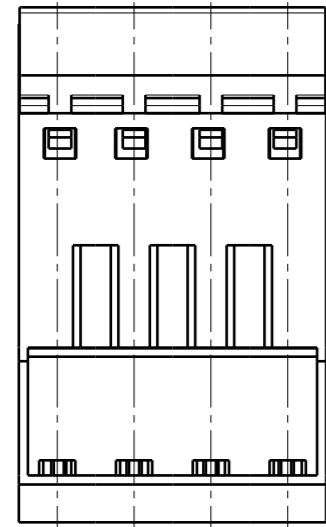
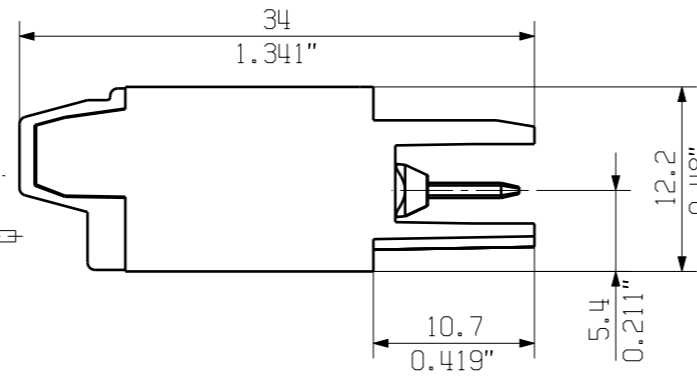
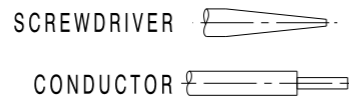
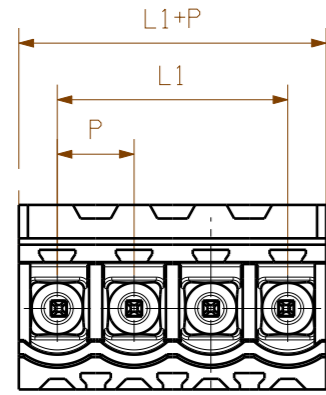

SHOWN: SLT 5.08/04/180B

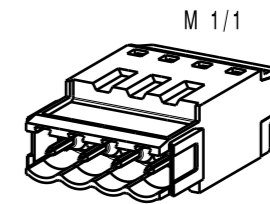
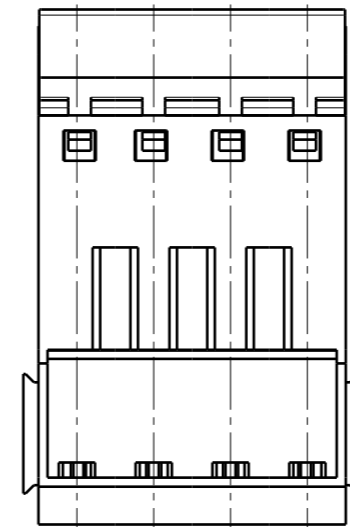
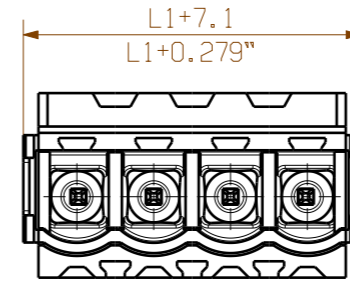

SHOWN: SLT 5.08/04/180DF

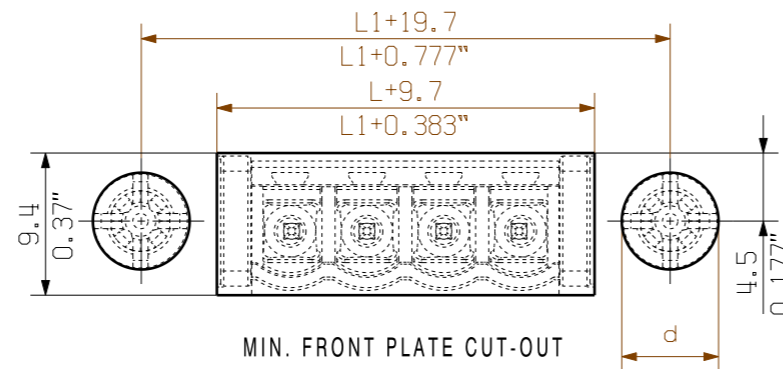
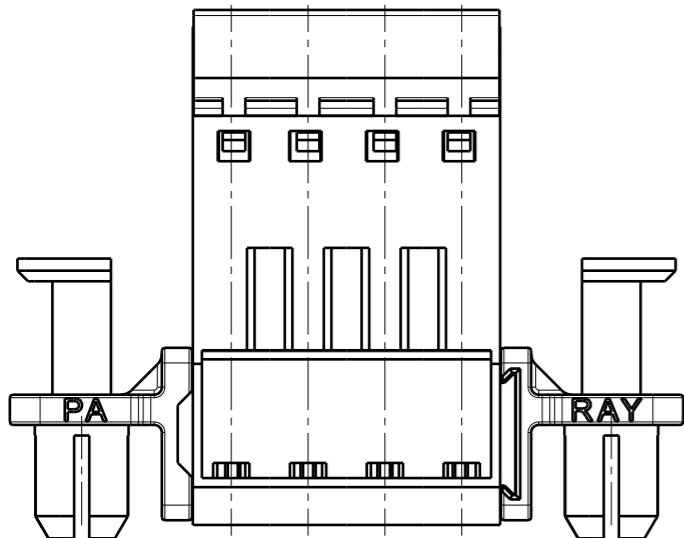
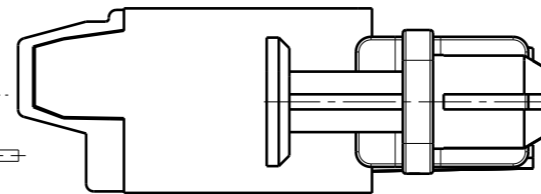
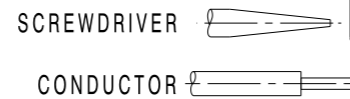
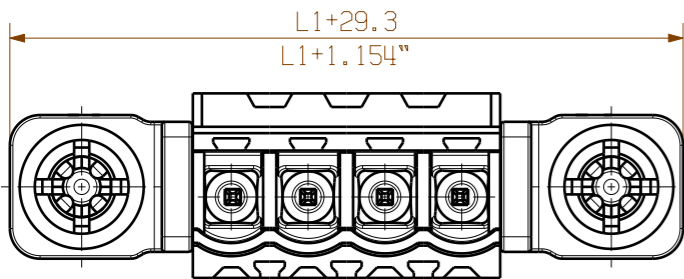

0.5-0.8	0.019-0.031	6.3	0.248
1.00	0.039	6.4	0.252
1.5	0.059	6.5	0.256
2.00	0.079	6.7	0.264
WANDDICKE WALL THICKNESS [mm]	WANDDICKE WALL THICKNESS [inch]	d [mm]	d [inch]

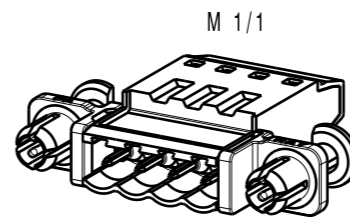

P=5.08 RASTER PITCH

For the mounting of PCBs, it should be noted that the rated data relates only to the PCB components alone. The necessary creepage and clearance paths must be observed in connection with the respective applicant in accordance to IEC 664 / VDE 0110. The current-carrying capacity and pitch tolerance is to be determined according to DIN IEC 326 part 3 very fine.

Weidmüller PCB components are tested to the DIN EN 61984 standard, and are valid for its field of application. Provided that the components are used to the intended purpose, all requirements with respect to the occurring of electrical, mechanical, thermic and corrosive stress will be satisfied.

24	106.84	4.600
23	111.76	4.400
22	106.68	4.200
21	101.60	4.000
20	96.52	3.800
19	91.44	3.600
18	86.36	3.400
17	81.28	3.200
16	76.20	3.000
15	71.12	2.800
14	66.04	2.600
13	60.96	2.400
12	55.88	2.200
11	50.80	2.000
10	45.72	1.800
9	40.64	1.600
8	35.56	1.400
7	30.48	1.200
6	25.40	1.000
5	20.32	0.800
4	15.24	0.600
3	10.16	0.400
2	5.08	0.200
n POLES	L1 [mm]	L1 [inch]

	METRIC TOLERANCES X. = ±0.3 X.X = ±0.1 X.XX = ±0.05	70330/5 24.05.13 HELIS_MA 01	CAT.NO.: <b>C 21246 05</b>
	MODIFICATION	DATE 14.06.2012	NAME HECKERT_M
DRAWN	RESPONSIBLE	CHECKED	APPROVED
SCALE: 2/1 SUPERSEDES:	DATE 07.06.2013	NAME HECKERT_M	PRODUCT FILE: SLT 5.08

**SLT 5.08/.../180...**  
 STIFTSTECKER  
 MALE PLUG

SHEET 01 OF 01 SHEETS

7315

WEIDMÜLLER INTERFACE GmbH & Co. KG  
 WEITERGABE SOWIE Vervielfältigung dieses Dokuments, Verwertung und Mitteilung seines Inhalts sind verboten, soweit nicht ausdrücklich gestattet. Zuwiderhandlungen verpflichten zu Schadenersatz. Alle Rechte für den Fall der Patent-, Gebrauchsmuster- oder Geschmacksmusterertragsung vorbehalten. THE REPRODUCTION, DISTRIBUTION AND UTILIZATION OF THIS DOCUMENT AS WELL AS THE COMMUNICATION OF ITS CONTENTS TO OTHERS WITHOUT EXPLICIT AUTHORIZATION IS PROHIBITED. OFFENDERS WILL BE HELD LIABLE FOR THE PAYMENT OF DAMAGES.