

OMNIMATE Signal - series BL/SL 3.50 SL 3.50/12/90G 3.2SN OR BX

Weidmüller Interface GmbH & Co. KG
Klingenbergstraße 26
D-32758 Detmold
Germany
Fon: +49 5231 14-0
Fax: +49 5231 14-292083
www.weidmueller.com

Product image

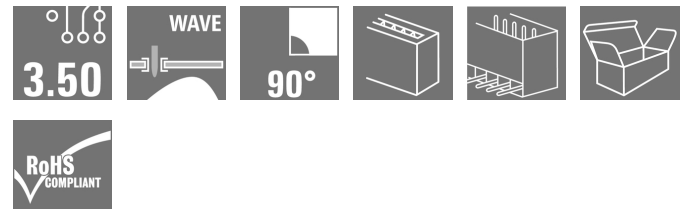
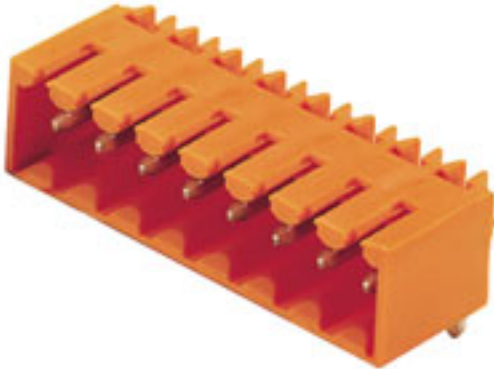

Similar to illustration

Pin headers for wave soldering in 3.50 mm pitch

- Plugging direction is parallel (90°), straight 180° or angled (135°) to the PCB
- Housing variant: screw flange (F)
- Packed in a cardboard box (BX)
- Pin header can be coded

General ordering data

Type	SL 3.50/12/90G 3.2SN OR BX
Order No.	1605170000
Version	PCB plug-in connector, male header, closed side, THT solder connection, 3.50 mm, Number of poles: 12, 90°, Solder pin length (l): 3.2 mm, tinned, orange, Box
GTIN (EAN)	4008190096342
Qty.	50 pc(s).
Product data	IEC: / 17 A UL: 300 V / 10 A
Packaging	Box

Creation date May 3, 2020 10:12:30 PM CEST

**OMNIMATE Signal - series BL/SL 3.50
SL 3.50/12/90G 3.2SN OR BX**

Weidmüller Interface GmbH & Co. KG
Klingenbergstraße 26
D-32758 Detmold
Germany
Fon: +49 5231 14-0
Fax: +49 5231 14-292083
www.weidmueller.com

Technical data**Dimensions and weights**

Width	43.4 mm	Width (inches)	1.709 inch
Height	10.7 mm	Height (inches)	0.421 inch
Height of lowest version	7.5 mm	Depth	11.1 mm
Depth (inches)	0.437 inch	Net weight	3.66 g

System specifications

Product family	OMNIMATE Signal - series BL/SL 3.50	Type of connection	Board connection
Mounting onto the PCB	THT solder connection	Pitch in mm (P)	3.5 mm
Pitch in inches (P)	0.138 inch	Outgoing elbow	90°
Number of poles	12	Number of solder pins per pole	1
Solder pin length (l)	3.2 mm	Solder pin length tolerance	+0.1 / -0.3 mm
Tolerance of solder pin position	± 0.15 mm	Solder pin dimensions	d = 1.2 mm, Octagonal
Solder pin dimensions = d tolerance	0 / -0.03 mm	Solder eyelet hole diameter (D)	1.4 mm
Solder eyelet hole diameter tolerance (D)+	0,1 mm	L1 in mm	38.5 mm
L1 in inches	1.516 inch	Number of rows	1
Pin series quantity	1	Touch-safe protection acc. to DIN VDE 57 106	Safe from back-of-hand touch
Touch-safe protection acc. to DIN VDE 0470	IP 10	Volume resistance	6.00 mΩ
Can be coded	Yes	Plugging cycles	25
Plugging force/pole, max.	10 N	Pulling force/pole, max.	10 N

Material data

Insulating material	PBT	Colour	orange
Colour chart (similar)	RAL 2000	Insulating material group	IIIa
Comparative Tracking Index (CTI)	≥ 200	Insulation strength	≥ 10 ⁸ Ω
UL 94 flammability rating	V-0	GWFI	960 °C
Contact base material	CuSn	Contact material	CuSn
Contact surface	tinned	Layer structure of solder connection	2-4 μm Ni / 5-8 μm Sn glossy
Layer structure of plug contact	2-4 undefined Ni / 5-8 undefined Sn glossy	Storage temperature, min.	-25 °C
Storage temperature, max.	50 °C	Max. relative humidity during storage	70 %
Operating temperature, min.	-50 °C	Operating temperature, max.	100 °C
Temperature range, installation, min.	-30 °C	Temperature range, installation, max.	100 °C

Rated data acc. to IEC

tested acc. to standard	IEC 60664-1, IEC 61984	Rated current, min. number of poles (Tu=20°C)	17 A
Rated current, max. number of poles (Tu=20°C)	12 A	Rated current, min. number of poles (Tu=40°C)	14.5 A
Rated current, max. number of poles (Tu=40°C)	10 A		

**OMNIMATE Signal - series BL/SL 3.50
SL 3.50/12/90G 3.2SN OR BX**

Weidmüller Interface GmbH & Co. KG
 Klingenbergstraße 26
 D-32758 Detmold
 Germany
 Fon: +49 5231 14-0
 Fax: +49 5231 14-292083
 www.weidmueller.com

Technical data**Rated data acc. to CSA**

Institute (CSA)		Certificate No. (CSA)	154685-1318353
Rated voltage (Use group B / CSA)	300 V	Rated voltage (Use group D / CSA)	300 V
Rated current (Use group B / CSA)	10 A	Rated current (Use group D / CSA)	10 A
Reference to approval values	Specifications are maximum values, details - see approval certificate.		

Rated data acc. to UL 1059

Institute (UR)		Certificate No. (UR)	E60693
Rated voltage (Use group B / UL 1059)	300 V	Rated voltage (Use group D / UL 1059)	300 V
Rated current (Use group B / UL 1059)	10 A	Rated current (Use group D / UL 1059)	10 A
Reference to approval values	Specifications are maximum values, details - see approval certificate.		

Packing

Packaging	Box	VPE length	68 mm
VPE width	81 mm	VPE height	104 mm

Classifications

ETIM 6.0	EC002637	ETIM 7.0	EC002637
eClass 9.0	27-44-04-02	eClass 9.1	27-44-04-02
eClass 10.0	27-44-04-02	UNSPSC	30-21-18-10

Notes

Notes	<ul style="list-style-type: none"> • Additional colours on request • Gold-plated contact surfaces on request • Rated current related to rated cross-section & min. No. of poles. • P on drawing = pitch • Rated data refer only to the component itself. Clearance and creepage distances to other components are to be designed in accordance with the relevant application standards.
IPC conformity	Conformity: The products are developed, manufactured and delivered according international recognized standards and norms and comply with the assured properties in the data sheet resp. fulfill decorative properties in accordance with IPC-A-610 "Class 2". Further claims on the products can be evaluated on request.

Data sheet

**OMNIMATE Signal - series BL/SL 3.50
SL 3.50/12/90G 3.2SN OR BX**

Weidmüller Interface GmbH & Co. KG
Klingenbergstraße 26
D-32758 Detmold
Germany
Fon: +49 5231 14-0
Fax: +49 5231 14-292083
www.weidmueller.com

Technical data

Approvals

Approvals



ROHS

Conform

Downloads

Approval/Certificate/Document of
Conformity

[Declaration of the Manufacturer](#)

Brochure/Catalogue

- [FL DRIVES EN](#)
- [MB SMT EN](#)
- [FL DRIVES DE](#)
- [MB DEVICE MANUF. EN](#)
- [CAT 2 PORTFOLIOGUIDE EN](#)
- [FL BUILDING SAFETY EN](#)
- [FL APPL LED LIGHTING EN](#)
- [FLIndustr.CONTROLS EN](#)
- [FL MACHINE SAFETY EN](#)
- [FL HEATING ELECTR EN](#)
- [FL APPL INVERTER EN](#)
- [FL_BASE_STATION_EN](#)
- [FL ELEVATOR EN](#)
- [FL POWER SUPPLY EN](#)
- [FL 72H SAMPLE SER EN](#)
- [PO OMNIMATE EN](#)

Engineering Data

[SL.zip](#)
[STEP](#)

**OMNIMATE Signal - series BL/SL 3.50
SL 3.50/12/90G 3.2SN OR BX**

Weidmüller Interface GmbH & Co. KG
 Klingenbergstraße 26
 D-32758 Detmold
 Germany
 Fon: +49 5231 14-0
 Fax: +49 5231 14-292083
 www.weidmueller.com

Drawings

Dimensional drawing

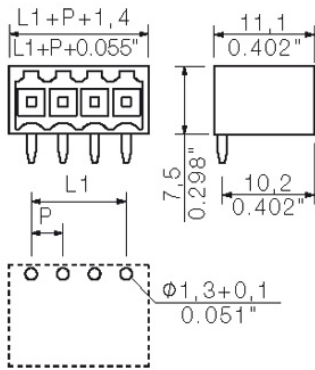

**OMNIMATE Signal - series BL/SL 3.50
SL 3.50/12/90G 3.2SN OR BX**

Weidmüller Interface GmbH & Co. KG
Klingenbergstraße 26
D-32758 Detmold
Germany
Fon: +49 5231 14-0
Fax: +49 5231 14-292083
www.weidmueller.com

Mating connector (conditionally pluggable)
BL 3.50/180LH

Female connectors with clamping yoke screw system for connecting conductors at 3.50 mm pitch. They provide space for labelling and can be coded.

General ordering data

Type	BL 3.50/12/180LH SN BK ...	Version	Product data	Packaging
Order No.	1687980000	PCB plug-in connector, female plug, 3.50 mm, Number of poles: 12,	IEC: 320 V / 17 A / 0.2 - 1.5 mm ²	Box
GTIN (EAN)	4008190853532	180°, Clamping yoke connection, Clamping range, max. : 1.5 mm ² ,	UL: 300 V / 10 A / AWG 28 - AWG 14	
Qty.	36 pc(s).	Box		
Type	BL 3.50/12/180LH SN OR ...	Version	Product data	Packaging
Order No.	1687750000	PCB plug-in connector, female plug, 3.50 mm, Number of poles: 12,	IEC: 320 V / 17 A / 0.2 - 1.5 mm ²	Box
GTIN (EAN)	4008190853303	180°, Clamping yoke connection, Clamping range, max. : 1.5 mm ² ,	UL: 300 V / 10 A / AWG 28 - AWG 14	
Qty.	36 pc(s).	Box		

BL 3.50/180F

Female connectors with clamping yoke screw system for connecting conductors at 3.50 mm pitch. They provide space for labelling and can be coded.

General ordering data

Type	BL 3.50/12/180F SN OR BX	Version	Product data	Packaging
Order No.	1606740000	PCB plug-in connector, female plug, 3.50 mm, Number of poles: 12,	IEC: 320 V / 17 A / 0.2 - 1.5 mm ²	Box
GTIN (EAN)	4008190147181	180°, Clamping yoke connection, Clamping range, max. : 1.5 mm ² ,	UL: 300 V / 10 A / AWG 28 - AWG 14	
Qty.	36 pc(s).	Box		
Type	BL 3.50/12/180F SN BK BX	Version	Product data	Packaging
Order No.	1615880000	PCB plug-in connector, female plug, 3.50 mm, Number of poles: 12,	IEC: 320 V / 17 A / 0.2 - 1.5 mm ²	Box
GTIN (EAN)	4008190063924	180°, Clamping yoke connection, Clamping range, max. : 1.5 mm ² ,	UL: 300 V / 10 A / AWG 28 - AWG 14	
Qty.	36 pc(s).	Box		
Type	BL 3.50/12/180F SN DKGN ...	Version	Product data	Packaging
Order No.	1621230000	PCB plug-in connector, female plug, 3.50 mm, Number of poles: 12,	IEC: 320 V / 17 A / 0.2 - 1.5 mm ²	Box
GTIN (EAN)	4008190169855	180°, Clamping yoke connection, Clamping range, max. : 1.5 mm ² ,	UL: 300 V / 10 A / AWG 28 - AWG 14	
Qty.	50 pc(s).	Box		
Type	BL 3.50/12/180F SN OR B ...	Version	Product data	Packaging
Order No.	1740761001	PCB plug-in connector, female plug, 3.50 mm, Number of poles: 12,	IEC: 320 V / 17 A / 0.2 - 1.5 mm ²	Box
GTIN (EAN)	4008190961794	180°, Clamping yoke connection, Clamping range, max. : 1.5 mm ² ,	UL: 300 V / 10 A / AWG 28 - AWG 14	
Qty.	36 pc(s).	Box		

**OMNIMATE Signal - series BL/SL 3.50
SL 3.50/12/90G 3.2SN OR BX**

Weidmüller Interface GmbH & Co. KG
Klingenbergstraße 26
D-32758 Detmold
Germany
Fon: +49 5231 14-0
Fax: +49 5231 14-292083
www.weidmueller.com

Mating connector (conditionally pluggable)

Type	BL 3.50/12/180F SN GY BX	Version	Product data	Packaging
Order No.	1621020000	PCB plug-in connector, female plug, 3.50 mm, Number of poles: 12,	IEC: 320 V / 17 A / 0.2 - 1.5 mm ²	Box
GTIN (EAN)	4008190167752	180°, Clamping yoke connection, Clamping range, max. : 1.5 mm ² ,	UL: 300 V / 10 A / AWG 28 - AWG 14	
Qty.	50 pc(s).	Box		

BLIDC 3.5F SN

Female connectors for fast processing with insulation displacement connectors (IDC) for connecting wires at 3.50 pitch. They provide space for labelling and can be coded.

General ordering data

Type	BLIDC 3.50/12/180F SN O ...	Version	Product data	Packaging
Order No.	1751190000	PCB plug-in connector, female plug, 3.50 mm, Number of poles: 12,	IEC: 320 V / 6 A / 0.2 - 0.5 mm ²	Box
GTIN (EAN)	4032248146741	90°/270°, IDC terminal, Clamping range, max. : 0.5 mm ² , Box	UL: 300 V / 7 A / AWG 22 - AWG 20	
Qty.	50 pc(s).			

BL 3.50/90F

Female connectors with clamping yoke screw system for connecting conductors at 3.50 mm pitch. They provide space for labelling and can be coded.

General ordering data

Type	BL 3.50/12/90F SN BK BX	Version	Product data	Packaging
Order No.	1639340000	PCB plug-in connector, female plug, 3.50 mm, Number of poles: 12,	IEC: 320 V / 12 A / 0.2 - 1.5 mm ²	Box
GTIN (EAN)	4008190276881	90°, Clamping yoke connection, Clamping range, max. : 1.5 mm ² , Box	UL: 300 V / 8 A / AWG 28 - AWG 14	
Qty.	36 pc(s).			
Type	BL 3.50/12/90F SN OR BX	Version	Product data	Packaging
Order No.	1639110000	PCB plug-in connector, female plug, 3.50 mm, Number of poles: 12,	IEC: 320 V / 12 A / 0.2 - 1.5 mm ²	Box
GTIN (EAN)	4008190276652	90°, Clamping yoke connection, Clamping range, max. : 1.5 mm ² , Box	UL: 300 V / 8 A / AWG 28 - AWG 14	
Qty.	36 pc(s).			

**OMNIMATE Signal - series BL/SL 3.50
SL 3.50/12/90G 3.2SN OR BX**

Weidmüller Interface GmbH & Co. KG
 Klingenbergstraße 26
 D-32758 Detmold
 Germany
 Fon: +49 5231 14-0
 Fax: +49 5231 14-292083
 www.weidmueller.com

Mating connector (conditionally pluggable)
BL 3.50/270F



Female connectors with clamping yoke screw system for connecting conductors at 3.50 mm pitch. They provide space for labelling and can be coded.

General ordering data

Type	BL 3.50/12/270F SN OR BX	Version	Product data	Packaging
Order No.	1640030000	PCB plug-in connector, female plug, 3.50 mm, Number of poles: 12,	IEC: 320 V / 12 A / 0.2 - 1.5 mm ²	Box
GTIN (EAN)	4008190277581	270°, Clamping yoke connection, Clamping range, max. : 1.5 mm ² ,	UL: 300 V / 8 A / AWG 28 - AWG 14	
Qty.	36 pc(s).	Box		
Type	BL 3.50/12/270F SN BK BX	Version	Product data	Packaging
Order No.	1640260000	PCB plug-in connector, female plug, 3.50 mm, Number of poles: 12,	IEC: 320 V / 12 A / 0.2 - 1.5 mm ²	Box
GTIN (EAN)	4008190277840	270°, Clamping yoke connection, Clamping range, max. : 1.5 mm ² ,	UL: 300 V / 8 A / AWG 28 - AWG 14	
Qty.	36 pc(s).	Box		

**OMNIMATE Signal - series BL/SL 3.50
SL 3.50/12/90G 3.2SN OR BX**

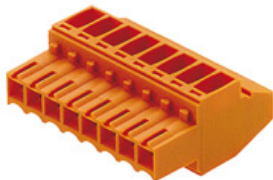
Weidmüller Interface GmbH & Co. KG
Klingenbergstraße 26
D-32758 Detmold
Germany
Fon: +49 5231 14-0
Fax: +49 5231 14-292083
www.weidmueller.com

Mating connector (fully pluggable)
BL 3.50/90

Female connectors with clamping yoke screw system for connecting conductors at 3.50 mm pitch. They provide space for labelling and can be coded.

General ordering data

Type	BL 3.50/12/90 SN OR BX	Version	Product data	Packaging
Order No.	1638650000	PCB plug-in connector, female plug, 3.50 mm, Number of poles: 12,	IEC: 320 V / 12 A / 0.2 - 1.5 mm ²	Box
GTIN (EAN)	4008190276195	90°, Clamping yoke connection, Clamping range, max. : 1.5 mm ² , Box	UL: 300 V / 8 A / AWG 28 - AWG 14	
Qty.	42 pc(s).			
Type	BL 3.50/12/90 SN BK BX	Version	Product data	Packaging
Order No.	1638880000	PCB plug-in connector, female plug, 3.50 mm, Number of poles: 12,	IEC: 320 V / 12 A / 0.2 - 1.5 mm ²	Box
GTIN (EAN)	4008190276423	90°, Clamping yoke connection, Clamping range, max. : 1.5 mm ² , Box	UL: 300 V / 8 A / AWG 28 - AWG 14	
Qty.	42 pc(s).			

BL 3.50/270

Female connectors with clamping yoke screw system for connecting conductors at 3.50 mm pitch. They provide space for labelling and can be coded.

General ordering data

Type	BL 3.50/12/270 SN OR BX	Version	Product data	Packaging
Order No.	1639570000	PCB plug-in connector, female plug, 3.50 mm, Number of poles: 12,	IEC: 320 V / 12 A / 0.2 - 1.5 mm ²	Box
GTIN (EAN)	4008190277123	270°, Clamping yoke connection, Clamping range, max. : 1.5 mm ² ,	UL: 300 V / 8 A / AWG 28 - AWG 14	
Qty.	42 pc(s).	Box		
Type	BL 3.50/12/270 SN BK BX	Version	Product data	Packaging
Order No.	1639800000	PCB plug-in connector, female plug, 3.50 mm, Number of poles: 12,	IEC: 320 V / 12 A / 0.2 - 1.5 mm ²	Box
GTIN (EAN)	4008190277352	270°, Clamping yoke connection, Clamping range, max. : 1.5 mm ² ,	UL: 300 V / 8 A / AWG 28 - AWG 14	
Qty.	42 pc(s).	Box		

**OMNIMATE Signal - series BL/SL 3.50
SL 3.50/12/90G 3.2SN OR BX**

Weidmüller Interface GmbH & Co. KG
Klingenbergstraße 26
D-32758 Detmold
Germany
Fon: +49 5231 14-0
Fax: +49 5231 14-292083
www.weidmueller.com

Mating connector (fully pluggable)
BLZF 3.5/180

Female connectors with tension clamp system for connecting cables in 3.50 pitch. They provide space for labelling and can be coded.

General ordering data

Type	BLZF 3.50/12/180 SN OR ...	Version	Product data	Packaging
Order No.	1690290000	PCB plug-in connector, female plug, 3.50 mm, Number of poles: 12,	IEC: 320 V / 14.5 A / 0.2 - 1.5 mm ²	Box
GTIN (EAN)	4008190328788	180°, Tension-clamp connection, Clamping range, max.: 1.5 mm ² ,	UL: 300 V / 10 A / AWG 26 - AWG 14	
Qty.	50 pc(s).	Box		
Type	BLZF 3.50/12/180 SN DKG ...	Version	Product data	Packaging
Order No.	1690750000	PCB plug-in connector, female plug, 3.50 mm, Number of poles: 12,	IEC: 320 V / 14.5 A / 0.2 - 1.5 mm ²	Box
GTIN (EAN)	4008190329266	180°, Tension-clamp connection, Clamping range, max.: 1.5 mm ² ,	UL: 300 V / 10 A / AWG 26 - AWG 14	
Qty.	50 pc(s).	Box		

BLIDC 3.5 SN

Female connectors for fast processing with insulation displacement connectors (IDC) for connecting wires at 3.50 pitch. They provide space for labelling and can be coded.

General ordering data

Type	BLIDC 3.50/12/180 SN OR ...	Version	Product data	Packaging
Order No.	1750890000	PCB plug-in connector, female plug, 3.50 mm, Number of poles: 12,	IEC: 320 V / 6 A / 0.2 - 0.5 mm ²	Box
GTIN (EAN)	4032248146192	90°/270°, IDC terminal, Clamping range, max.: 0.5 mm ² , Box	UL: 300 V / 7 A / AWG 22 - AWG 20	
Qty.	50 pc(s).			

**OMNIMATE Signal - series BL/SL 3.50
SL 3.50/12/90G 3.2SN OR BX**

Weidmüller Interface GmbH & Co. KG
Klingenbergstraße 26
D-32758 Detmold
Germany
Fon: +49 5231 14-0
Fax: +49 5231 14-292083
www.weidmueller.com

Mating connector (fully pluggable)
BL 3.50/180

Female connectors with clamping yoke screw system for connecting conductors at 3.50 mm pitch. They provide space for labelling and can be coded.

General ordering data

Type	BL 3.50/12/180 SN DKGN ...	Version	Product data	Packaging
Order No.	1606590000	PCB plug-in connector, female plug, 3.50 mm, Number of poles: 12,	IEC: 320 V / 17 A / 0.2 - 1.5 mm ²	Box
GTIN (EAN)	4008190130299	180°, Clamping yoke connection, Clamping range, max. : 1.5 mm ² ,	UL: 300 V / 10 A / AWG 28 - AWG 14	
Qty.	42 pc(s).	Box		
Type	BL 3.50/12/180 SN BK BX	Version	Product data	Packaging
Order No.	1615730000	PCB plug-in connector, female plug, 3.50 mm, Number of poles: 12,	IEC: 320 V / 17 A / 0.2 - 1.5 mm ²	Box
GTIN (EAN)	4008190060817	180°, Clamping yoke connection, Clamping range, max. : 1.5 mm ² ,	UL: 300 V / 10 A / AWG 28 - AWG 14	
Qty.	42 pc(s).	Box		
Type	BL 3.50/12/180 SN GY BX	Version	Product data	Packaging
Order No.	1620550000	PCB plug-in connector, female plug, 3.50 mm, Number of poles: 12,	IEC: 320 V / 17 A / 0.2 - 1.5 mm ²	Box
GTIN (EAN)	4008190159108	180°, Clamping yoke connection, Clamping range, max. : 1.5 mm ² ,	UL: 300 V / 10 A / AWG 28 - AWG 14	
Qty.	50 pc(s).	Box		
Type	BL 3.50/12/180 SN OR BX	Version	Product data	Packaging
Order No.	1597460000	PCB plug-in connector, female plug, 3.50 mm, Number of poles: 12,	IEC: 320 V / 17 A / 0.2 - 1.5 mm ²	Box
GTIN (EAN)	4008190192037	180°, Clamping yoke connection, Clamping range, max. : 1.5 mm ² ,	UL: 300 V / 10 A / AWG 28 - AWG 14	
Qty.	42 pc(s).	Box		
Type	BL 3.50/12/180 SN OR BX ...	Version	Product data	Packaging
Order No.	1674790000	PCB plug-in connector, female plug, 3.50 mm, Number of poles: 12,	IEC: 320 V / 17 A / 0.2 - 1.5 mm ²	Box
GTIN (EAN)	4008190444594	180°, Clamping yoke connection, Clamping range, max. : 1.5 mm ² ,	UL: 300 V / 10 A / AWG 28 - AWG 14	
Qty.	42 pc(s).	Box		

BLF 3.50/180

Connect efficiently - in a small space: female header with spring connection (PUSH IN) as a plug-in connection level; used together with male headers in 3.50 mm pitch.

General ordering data

Type	BLF 3.50/12/180 SN BK BX	Version	Product data	Packaging
Order No.	2459380000	PCB plug-in connector, female plug, 3.50 mm, Number of poles: 12,	IEC: 320 V / 17.5 A / 0.14 - 1.5 mm ²	Box
GTIN (EAN)	4050118474732	180°, PUSH IN, Spring connection, Clamping range, max. : 1.5 mm ² ,	UL: 300 V / AWG 26 - AWG 16	
Qty.	42 pc(s).	Box		

Data sheet

OMNIMATE Signal - series BL/SL 3.50 SL 3.50/12/90G 3.2SN OR BX

Weidmüller Interface GmbH & Co. KG
 Klingenbergstraße 26
 D-32758 Detmold
 Germany
 Fon: +49 5231 14-0
 Fax: +49 5231 14-292083
 www.weidmueller.com

Mating connector (fully pluggable)

Type	BLF 3.50/12/180 SN OR BX	Version	Product data	Packaging
Order No.	2459150000	PCB plug-in connector, female plug, 3.50 mm, Number of poles: 12,	IEC: 320 V / 17.5 A / 0.14 - 1.5 mm ²	Box
GTIN (EAN)	4050118474503	180°, PUSH IN, Spring connection, Clamping range, max. : 1.5 mm ² ,	UL: 300 V / AWG 26 - AWG 16	
Qty.	42 pc(s).	Box		

OMNIMATE Signal - series BL/SL 3.50 SL 3.50/12/90G 3.2SN OR BX

Weidmüller Interface GmbH & Co. KG
Klingenbergstraße 26
D-32758 Detmold
Germany
Fon: +49 5231 14-0
Fax: +49 5231 14-292083
www.weidmueller.com

Accessories

LED Light guides



Effective: the link between LED and front panel.

Floodlight indicators allow users to monitor the switching states without requiring a special design: optical plastic directs the light from standard LEDs around a bend into the connectors or through the front plate.

The fibre-optic elements are simply clipped behind the relevant 90° bend male connectors (90° outlet direction). Versions with different incoming light beam heights achieve maximum light efficiency for LEDs with different designs or heights.

The advantages compared to conventional solutions:

- No additional LED circuit board required behind the front panel
- No "long-legged" LEDs with separate mounting required
- Bent fibre-optic cable line for maximum light efficiency
- Uncomplicated front plate bore holes due to circular shape of outgoing light beam
- Easy to maintain correct clearance and creepage distance
- Can be partitioned for smaller pole numbers

The result: simplified manufacturing process, reduced costs and simplified design

General ordering data

Type	SL 3.5 FLA 4.0/1.75/8	Version	Product data	Packaging
Order No.	1597650000	PCB plug-in connector, Accessories, Flood-light display, Transparent,		Box
GTIN (EAN)	4008190027773	Number of poles: 1		
Qty.	50 pc(s).			
Type	SL 3.5 FLA 2.3/1.75/8	Version	Product data	Packaging
Order No.	1597640000	PCB plug-in connector, Accessories, Flood-light display, Transparent,		Box
GTIN (EAN)	4008190011321	Number of poles: 1		
Qty.	25 pc(s).			
Type	SL 3.5 FLA 1.5/8	Version	Product data	Packaging
Order No.	1597510000	PCB plug-in connector, Accessories, Flood-light display, Transparent,		Box
GTIN (EAN)	4008190127541	Number of poles: 1		
Qty.	50 pc(s).			
Type	SL 3.5 FLA 2.3/8	Version	Product data	Packaging
Order No.	1597520000	PCB plug-in connector, Accessories, Flood-light display, Transparent,		Box
GTIN (EAN)	4008190120566	Number of poles: 1		
Qty.	50 pc(s).			
Type	SL 3.5 FLA 4.0/8	Version	Product data	Packaging
Order No.	1597530000	PCB plug-in connector, Accessories, Flood-light display, Transparent,		Box
GTIN (EAN)	4008190075699	Number of poles: 1		
Qty.	50 pc(s).			
Type	SL 3.5 FLA 1.5/1.75/8	Version	Product data	Packaging
Order No.	1597630000	PCB plug-in connector, Accessories, Flood-light display, Transparent,		Box
GTIN (EAN)	4008190148386	Number of poles: 1		
Qty.	50 pc(s).			

OMNIMATE Signal - series BL/SL 3.50 SL 3.50/12/90G 3.2SN OR BX

Weidmüller Interface GmbH & Co. KG
 Klingenbergstraße 26
 D-32758 Detmold
 Germany
 Fon: +49 5231 14-0
 Fax: +49 5231 14-292083
 www.weidmueller.com

Accessories

Coding elements



Only connects what is supposed to be connected: the right connection at the right place.

Coding elements and locking devices clearly assign connecting elements during the manufacturing process and operation

The coding elements and locking devices are inserted prior to assembly or during the cable assembly phase. The Weidmüller alternative: configure online using the variant configurator to precode prior to delivery.

Incorrect assembly on the circuit board and incorrect plugging of connecting elements is no longer possible. The advantage: no troubleshooting during manufacture and no operational errors by the user.

General ordering data

Type	BL SL 3.5 KO OR	Version	Product data	Packaging
Order No.	1693430000	PCB plug-in connector, Accessories, Coding element, orange, Number		Box
GTIN (EAN)	4008190867447	of poles: 1		
Qty.	100 pc(s).			
Type	BL SL 3.5 KO SW	Version	Product data	Packaging
Order No.	1610100000	PCB plug-in connector, Accessories, Coding element, black, Number		Box
GTIN (EAN)	4008190187637	of poles: 1		
Qty.	100 pc(s).			

Additional accessories



No task is too small when creating the perfect solution. br />

Connections form just one part of the overall process. Small details are often the key to the perfect solution in applications where potentials are tested, grouped or even isolated.

A system is not a system without small but useful details:

- Test plugs - ensure reliable pick-up from diagnostic sockets
- Cross-connectors - ensure a stable electrical distribution contact directly at the connection
- Compartment partition elements - divide a large number of male connectors into several separate socket connector channels
- Locks and clips - optional vibration-resistant clip-on connection or mounting for male and female connectors

In tandem with the manufacturing process and application - more accessories = smaller workload

General ordering data

Type	BL/SL 3.50 VR OR BX	Version	Product data
Order No.	1669310000	PCB plug-in connector, Accessories, Latches, orange, Number of poles:	
GTIN (EAN)	4008190428488	1	
Qty.	100 pc(s).		

Data sheet

**OMNIMATE Signal - series BL/SL 3.50
SL 3.50/12/90G 3.2SN OR BX**

Weidmüller Interface GmbH & Co. KG
 Klingenbergstraße 26
 D-32758 Detmold
 Germany
 Fon: +49 5231 14-0
 Fax: +49 5231 14-292083
 www.weidmueller.com

Accessories

Type	BL/SL 3.50 VR BK BX	Version	Product data
Order No.	1669300000	PCB plug-in connector, Accessories, Latches, black, Number of poles:	
GTIN (EAN)	4008190428471	1	
Qty.	100 pc(s).		

The reproduction, distribution and utilization of this document as well as the communication of its contents to others without explicit authorization is prohibited. Offenders will be held liable for the payment of damages. Weidmüller exclusively reserves the right to file for patents, utility models or designs.

© Weidmüller Interface GmbH & Co. KG

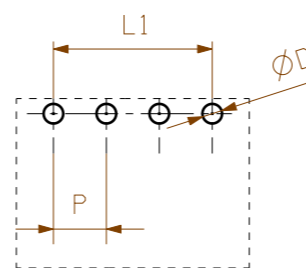
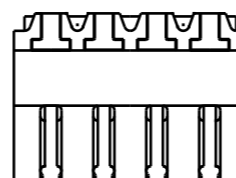
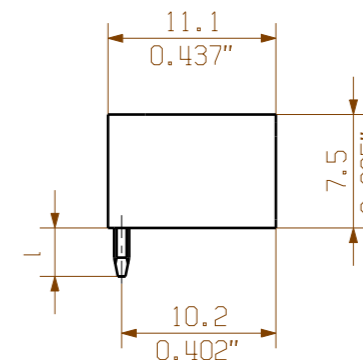
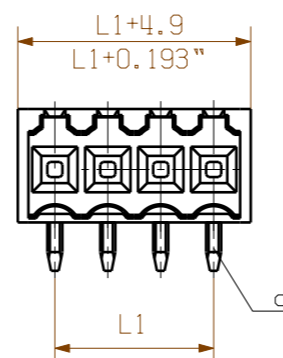

hole pattern

P = 3.50 Raster Pitch

D = Ø1,3^{+0.1}
Ø0.051^{+0.1}

d = 1,2mm oktogonal
0.047" octogonal

SHOWN: SL 3.50/04/90G

1,5	0,1 -0,3
3,2	0,1 -0,3
4,5	0,1 -0,3
pin length l / Stiftlänge l	tolerance / Toleranz

24	80.5	+/-0.2
23	77.0	
22	73.5	
21	70.0	
20	66.5	
19	63.0	
18	59.5	
17	56.0	+/-0.15
16	52.5	
15	49.0	
14	45.5	
13	42.0	+/-0.1
12	38.5	
11	35.0	
10	31.5	
9	28.0	
8	24.5	
7	21.0	
6	17.5	
5	14.0	+/-0.1
4	10.5	
3	7.0	+/-0.1
2	3.5	
n Polzahl/ no of poles	L1	Toleranz/ tolerance L1

For the mounting of PCBs, it should be noted that the rated data given in the catalogue relates only to the connection elements. The necessary creepage and clearance paths must be observed in connection with the respective applicant in accordance to VDE 0110. The current-carrying capacity and pitch tolerance is to be determined according to DIN IEC 326 part 3 very fine.

Weidmüller connectors are tested to the DIN VDE 0627 standard, and are valid for its field of application. Provided that the connectors are used to the intended purpose, all requirements with respect to the occurring of electrical, mechanical, thermal and corrosive stress will be satisfied.

General tolerance: DIN ISO 2768-mK		96310/5 06.07.17 HELIS_MA 00		Cat.no.: .	
		Modification			
		Drawn	Date	Name	SL 3.50/.. /90... STIFTLISTE MALE HEADER
Responsible	21.08.2008	HELIS_MA	Sheet 02 of 03 sheets		
Checked	20.09.2017	HERTEL_S	Issue no. 48		
Supersedes: .	Approved	LANG_T	Product file: SL 3.50	7296	

Recommended wave soldering profiles

Weidmüller Interface GmbH & Co. KG
 Klingenbergstraße 16
 D-32758 Detmold
 Germany
 Fon: +49 5231 14-0
 Fax: +49 5231 14-292083
 www.weidmueller.com

Single Wave:



Double Wave:



Wave soldering profiles

Wired connection elements should be processed in accordance with the DIN EN 61760-1 standard. We have included two recommendations for practical wave soldering profiles, with which Weidmüller PCB terminals and connectors are qualified.

When choosing a suitable profile for your application, the following factors also need to be considered:

- PCB thickness
- Proportion of Cu in the layers
- Single/double-sided assembly
- Product range
- Heating and cooling rates

The single and double wave profiles each indicate the recommended operating range, including the maximum soldering temperature of 260°C. In practice, the maximum soldering temperature is quite often well below the above maximum profile.