

OMNIMATE Signal - series BL/SL 3.50 BL-I/O 3.50/10/180LR SN BK BX

Weidmüller Interface GmbH & Co. KG
Klingenbergstraße 26
D-32758 Detmold
Germany
Fon: +49 5231 14-0
Fax: +49 5231 14-292083
www.weidmueller.com

Product image

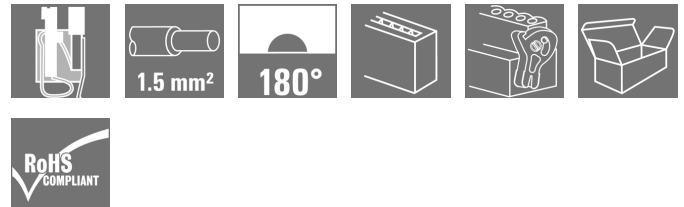

Similar to illustration

Female plugs with spring connection (PUSH IN) as a plug-in connection level for decentralised I/O electronic components; used together with male headers in a 3.50-mm pitch.

General ordering data

Type	BL-I/O 3.50/10/180LR SN BK BX
Order No.	1531180000
Version	PCB plug-in connector, female plug, 3.50 mm, Number of poles: 10, 180°, PUSH IN, Spring connection, Clamping range, max. : 1.5 mm², Box
GTIN (EAN)	4050118336245
Qty.	20 pc(s).
Product data	IEC: 200 V / 2.2 A / 0.2 - 1.5 mm² UL: 50 V / 5 A / AWG 24 - AWG 16
Packaging	Box

Creation date May 4, 2020 1:31:58 AM CEST

**OMNIMATE Signal - series BL/SL 3.50
BL-I/O 3.50/10/180LR SN BK BX**

Weidmüller Interface GmbH & Co. KG
 Klingenbergstraße 26
 D-32758 Detmold
 Germany
 Fon: +49 5231 14-0
 Fax: +49 5231 14-292083
 www.weidmueller.com

Technical data**Dimensions and weights**

Width	42.3 mm	Width (inches)	1.665 inch
Height	14.5 mm	Height (inches)	0.571 inch
Depth	29.1 mm	Depth (inches)	1.146 inch
Net weight	5.705 g		

System Parameters

Product family	OMNIMATE Signal - series BL/SL 3.50	Type of connection	Field connection
Wire connection method	PUSH IN, Spring connection	Pitch in mm (P)	3.5 mm
Pitch in inches (P)	0.138 inch	Conductor outlet direction	180°
Number of poles	10	L1 in mm	31.5 mm
L1 in inches	1.24 inch	Pin series quantity	1
Rated cross-section	1 mm ²	Touch-safe protection acc. to DIN VDE 57 106	Safe from finger touch
Touch-safe protection acc. to DIN VDE 0470	IP 20	Volume resistance	≤ 5mΩ
Can be coded	Yes	Stripping length	8 mm
Screwdriver blade	0.4 x 2.5	Screwdriver blade standard	DIN 5264
Plugging force/pole, max.	6 N	Pulling force/pole, max.	6 N

Material data

Insulating material	PBT	Colour	black
Colour of operational elements	grey, blue, red	Material of operational elements	PBT
Colour chart (similar)	RAL 9011	Insulating material group	IIIa
Comparative Tracking Index (CTI)	≥ 200	Insulation strength	≥ 10 ⁸ Ω
UL 94 flammability rating	V-0	GWFI	960 °C
Contact base material	Copper alloy	Contact material	Copper alloy
Contact surface	tinned	Storage temperature, min.	-25 °C
Storage temperature, max.	50 °C	Max. relative humidity during storage	70 %
Operating temperature, min.	-50 °C	Operating temperature, max.	75 °C
Temperature range, installation, min.	-30 °C	Temperature range, installation, max.	75 °C

Conductors suitable for connection

Clamping range, min.	0.2 mm ²
Clamping range, max.	1.5 mm ²
Wire connection cross section AWG, min.	AWG 24
Wire connection cross section AWG, max.	AWG 16
Solid, min. H05(07) V-U	0.2 mm ²
Solid, max. H05(07) V-U	1.5 mm ²
Flexible, min. H05(07) V-K	0.2 mm ²
Flexible, max. H05(07) V-K	1.5 mm ²
w. plastic collar ferrule, DIN 46228 pt 4, 0.2 mm ² min.	
w. plastic collar ferrule, DIN 46228 pt 4, 0.75 mm ² max.	
w. wire end ferrule, DIN 46228 pt 1, min.	0.2 mm ²
w. wire end ferrule, DIN 46228 pt 1, max.	1 mm ²

Creation date May 4, 2020 1:31:58 AM CEST

OMNIMATE Signal - series BL/SL 3.50 BL-I/O 3.50/10/180LR SN BK BX

Weidmüller Interface GmbH & Co. KG
Klingenbergstraße 26
D-32758 Detmold
Germany
Fon: +49 5231 14-0
Fax: +49 5231 14-292083
www.weidmueller.com

Technical data

Plug gauge in accordance with EN 60999 a x b; ø 2.4 mm x 1.5 mm; 1.9mm

Clampable conductor	Cross-section for conductor connection	Type	fine-wired
		nominal	0.25 mm ²
wire end ferrule		Stripping length	nominal 10 mm
		Recommended wire-end ferrule	H0.25/12 HBL
Clampable conductor	Cross-section for conductor connection	Type	fine-wired
		nominal	0.34 mm ²
wire end ferrule		Stripping length	nominal 10 mm
		Recommended wire-end ferrule	H0.34/12 TK
Clampable conductor	Cross-section for conductor connection	Type	fine-wired
		nominal	0.5 mm ²
wire end ferrule		Stripping length	nominal 10 mm
		Recommended wire-end ferrule	H0.5/14 OR
Clampable conductor	Cross-section for conductor connection	Type	fine-wired
		nominal	0.75 mm ²
wire end ferrule		Stripping length	nominal 10 mm
		Recommended wire-end ferrule	H0.75/14T HBL

Reference text Other cables on request

Max. clamping range 1.5 mm²

Rated data acc. to IEC

tested acc. to standard	IEC 60664-1, IEC 61984	Rated current, min. number of poles (Tu=20°C)	2.2 A
Rated current, max. number of poles (Tu=20°C)	2 A	Rated current, min. number of poles (Tu=40°C)	2.2 A
Rated current, max. number of poles (Tu=40°C)	2 A	Rated voltage for surge voltage class / pollution degree II/2	200 V
Rated voltage for surge voltage class / pollution degree III/2	160 V	Rated voltage for surge voltage class / pollution degree III/3	50 V
Rated impulse voltage for surge voltage class/ pollution degree II/2	2.5 kV	Rated impulse voltage for surge voltage class/ pollution degree III/2	2.5 kV
Rated impulse voltage for surge voltage class/ contamination degree III/3	0.8 kV	Short-time withstand current resistance	3 x 1s with 120 A

Rated data acc. to CSA

Rated voltage (Use group B / CSA)	50 V	Rated voltage (Use group D / CSA)	50 V
Rated current (Use group B / CSA)	5 A	Rated current (Use group D / CSA)	5 A
Wire cross-section, AWG, min.	AWG 22	Wire cross-section, AWG, max.	AWG 16

Rated data acc. to UL 1059

Institute (UR)		Certificate No. (UR)	E60693
Rated voltage (Use group B / UL 1059)	50 V	Rated voltage (Use group D / UL 1059)	50 V
Rated current (Use group B / UL 1059)	5 A	Rated current (Use group D / UL 1059)	5 A
Wire cross-section, AWG, min.	AWG 24	Wire cross-section, AWG, max.	AWG 16
Reference to approval values	Specifications are maximum values, details - see approval certificate.		

Creation date May 4, 2020 1:31:58 AM CEST

Data sheet

OMNIMATE Signal - series BL/SL 3.50 BL-I/O 3.50/10/180LR SN BK BX

Weidmüller Interface GmbH & Co. KG
Klingenbergstraße 26
D-32758 Detmold
Germany
Fon: +49 5231 14-0
Fax: +49 5231 14-292083
www.weidmueller.com

Technical data

Packing

Packaging	Box	VPE length	35 mm
VPE width	105 mm	VPE height	140 mm

Classifications

ETIM 6.0	EC002638	ETIM 7.0	EC002638
eClass 9.0	27-44-03-09	eClass 9.1	27-44-03-09
eClass 10.0	27-44-03-09		

Notes

Notes	<ul style="list-style-type: none"> • Additional colours on request • P on drawing = pitch • Crimp form A for wire end ferrules with PZ 6/5 crimping tool are recommended for the largest cable sizes. • Total load-carrying capacity of the potential bridges when feeding with 1.5 mm² is max. 17.5 A (so the capacity is 2.18 A for poles 2 through 9) • Wire end ferrule without plastic collar to DIN 46228/1 • Wire end ferrule with plastic collar to DIN 46228/4 • Conductor < 0.2 mm² tinned • Max. outer diameter of the conductor: 2.9 mm • Rated data refer only to the component itself. Clearance and creepage distances to other components are to be designed in accordance with the relevant application standards.
IPC conformity	Conformity: The products are developed, manufactured and delivered according international recognized standards and norms and comply with the assured properties in the data sheet resp. fulfill decorative properties in accordance with IPC-A-610 "Class 2". Further claims on the products can be evaluated on request.

Approvals

Approvals



ROHS

Conform

**OMNIMATE Signal - series BL/SL 3.50
BL-I/O 3.50/10/180LR SN BK BX**

Weidmüller Interface GmbH & Co. KG
Klingenbergstraße 26
D-32758 Detmold
Germany
Fon: +49 5231 14-0
Fax: +49 5231 14-292083
www.weidmueller.com

Technical data**Downloads**

Approval/Certificate/Document of Conformity	Declaration of the Manufacturer
Brochure/Catalogue	FL DRIVES EN MB DEVICE MANUF. EN FL DRIVES DE FL BUILDING SAFETY EN FL APPL LED LIGHTING EN FLIndustr.CONTROLS EN FL MACHINE SAFETY EN FL HEATING ELECTR EN FL APPL INVERTER EN FL_BASE_STATION_EN FL ELEVATOR EN FL POWER SUPPLY EN FL 72H SAMPLE SER EN PO OMNIMATE EN
Engineering Data	STEP
Product Change Notification	Change of Material LR 3.50 - DE Change of Material LR 3.50 - EN
White paper PUSH IN wire connection	Download Whitepaper

Data sheet

**OMNIMATE Signal - series BL/SL 3.50
BL-I/O 3.50/10/180LR SN BK BX**

Weidmüller Interface GmbH & Co. KG
Klingenbergstraße 26
D-32758 Detmold
Germany
Fon: +49 5231 14-0
Fax: +49 5231 14-292083
www.weidmueller.com

Drawings

Dimensional drawing

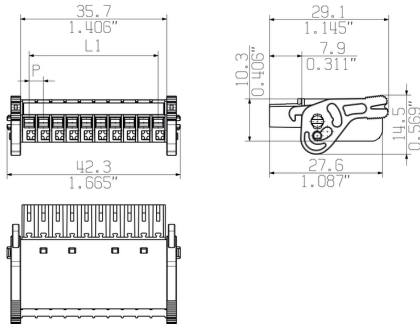

PUSH IN - fast and secure
Invented by Weidmüller

Graph

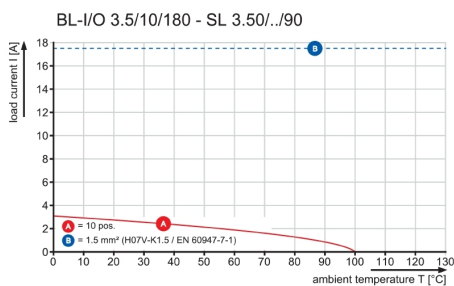

Product benefits

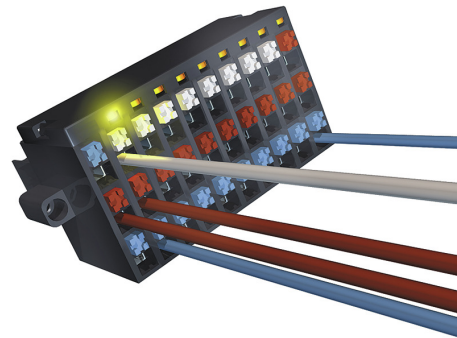

Integrated electronics
For more space on the circuit board

Graph

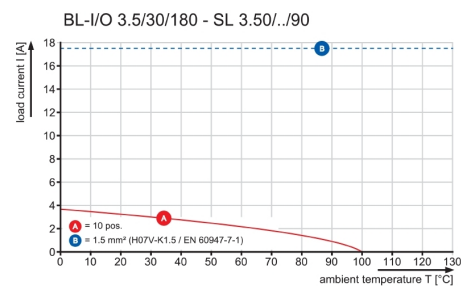

Product benefits

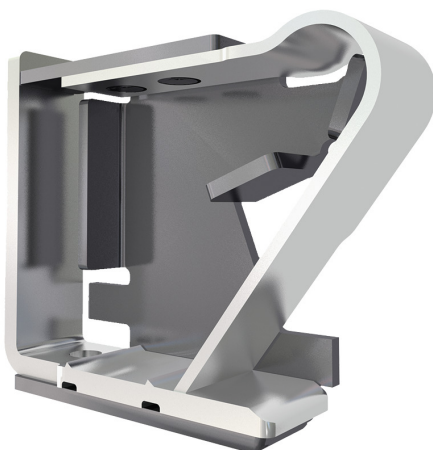

Solid PUSH IN contact
Safe and durable

Product benefits

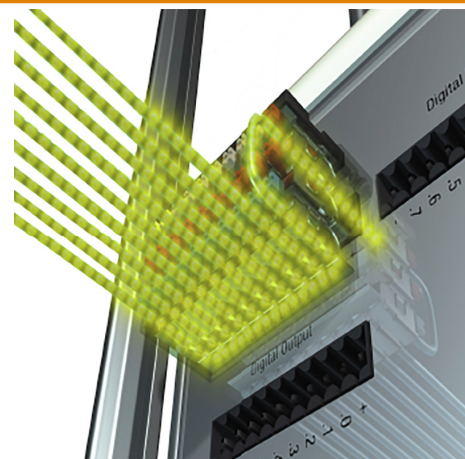

Multiplies the potential
Low wiring costs

**OMNIMATE Signal - series BL/SL 3.50
BL-I/O 3.50/10/180LR SN BK BX**

Weidmüller Interface GmbH & Co. KG
Klingenbergstraße 26
D-32758 Detmold
Germany
Fon: +49 5231 14-0
Fax: +49 5231 14-292083
www.weidmueller.com

Mating connector (fully pluggable)
SL-SMT 3.5/90RF

High-temperature-resistant male header, 3.50 mm pitch.

- **Plugging direction parallel (90°), straight 180° or angled (135°) to PCB**
- **Housing variants: closed side (G), screw flange (F), solder flange (LF) or snap-on solder flange (RF)**
- **Optimised for the SMT process**
- **Pin length 3.2 mm universal for all soldering methods**
- **Pin length 1.5 mm optimised for reflow soldering methods**
- **Packed either in a box (BX) or tape-on-reel (RL)**
- **Male header can be coded**

General ordering data

Type	SL-SMT 3.50/10/90RF 1.5 ...	Version	Product data	Packaging
Order No.	1060780000	PCB plug-in connector, male header, Clip-on flange, THT/THR solder connection, 3.50 mm, Number of poles: 10, 90°, Solder pin length (l): 1.5 mm, tinned, black, Box	IEC: 320 V / 15 A UL: 300 V / 10 A	Box
GTIN (EAN)	4032248810246			
Qty.	50 pc(s).			

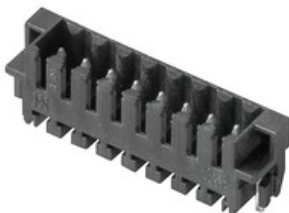
SL-SMT 3.5/180RF

High-temperature-resistant male header, 3.50 mm pitch.

- **Plugging direction parallel (90°), straight 180° or angled (135°) to PCB**
- **Housing variants: closed side (G), screw flange (F), solder flange (LF) or snap-on solder flange (RF)**
- **Optimised for the SMT process**
- **Pin length 3.2 mm universal for all soldering methods**
- **Pin length 1.5 mm optimised for reflow soldering methods**
- **Packed either in a box (BX) or tape-on-reel (RL)**
- **Male header can be coded**

General ordering data

Type	SL-SMT 3.50/10/180RF 1.5 ...	Version	Product data	Packaging
Order No.	1291390000	PCB plug-in connector, male header, Clip-on flange, THT/THR solder connection, 3.50 mm, Number of poles: 10, 180°, Solder pin length (l): 1.5 mm, tinned, black, Box	IEC: 320 V / 15 A UL: 300 V / 10 A	Box
GTIN (EAN)	4050118085266			
Qty.	50 pc(s).			

OMNIMATE Signal - series BL/SL 3.50 BL-I/O 3.50/10/180LR SN BK BX

Weidmüller Interface GmbH & Co. KG
 Klingenbergstraße 26
 D-32758 Detmold
 Germany
 Fon: +49 5231 14-0
 Fax: +49 5231 14-292083
 www.weidmueller.com

Accessories

PZ



Crimping tools for wire end ferrules, with and without plastic collars

- Ratchet guarantees precise crimping
- Release option in the event of incorrect operation

General ordering data

Type	PZ 1.5	Version
Order No.	9005990000	Pressing tool, Crimping tool for wire-end ferrules, 0.14mm ² , 1.5mm ² ,
GTIN (EAN)	4008190085964	Trapezoidal crimp
Qty.	1 pc(s).	
Type	PZ 6/5	Version
Order No.	9011460000	Pressing tool, Crimping tool for wire-end ferrules, 0.25mm ² , 6mm ² ,
GTIN (EAN)	4008190165352	Trapezoidal indentation crimp
Qty.	1 pc(s).	

Coding elements



Only connects what is supposed to be connected: the right connection at the right place.

Coding elements and locking devices clearly assign connecting elements during the manufacturing process and operation

The coding elements and locking devices are inserted prior to assembly or during the cable assembly phase.

The Weidmüller alternative: configure online using the variant configurator to precode prior to delivery.

Incorrect assembly on the circuit board and incorrect plugging of connecting elements is no longer possible.

The advantage: no troubleshooting during manufacture and no operational errors by the user.

General ordering data

Type	BL SL 3.5 KO OR	Version	Product data	Packaging
Order No.	1693430000	PCB plug-in connector, Accessories, Coding element, orange, Number		Box
GTIN (EAN)	4008190867447	of poles: 1		
Qty.	100 pc(s).			
Type	BL SL 3.5 KO SW	Version	Product data	Packaging
Order No.	1610100000	PCB plug-in connector, Accessories, Coding element, black, Number		Box
GTIN (EAN)	4008190187637	of poles: 1		
Qty.	100 pc(s).			

Data sheet

**OMNIMATE Signal - series BL/SL 3.50
BL-I/O 3.50/10/180LR SN BK BX**

Weidmüller Interface GmbH & Co. KG
Klingenbergstraße 26
D-32758 Detmold
Germany
Fon: +49 5231 14-0
Fax: +49 5231 14-292083
www.weidmueller.com

Accessories

Slotted screwdriver

Slotted screwdriver with rounded blade SD DIN 5265, ISO 2380/2, output to DIN 5264, ISO 2380/1. ChromTop tip, SoftFinish grip



General ordering data

Type	SDS 0.4X2.5X75	Version
Order No.	9009030000	Screwdriver, Blade width (B): 2.5 mm, Blade length: 75 mm, Blade thickness (A): 0.4 mm
GTIN (EAN)	4032248266944	
Qty.	1 pc(s).	

Slotted screwdriver

VDE insulated slot-head screwdriver, SDI DIN 7437, ISO 2380/2, drive output acc. to DIN 5264, ISO 2380/1. SoftFinish grip



General ordering data

Type	SDIS 0.4X2.5X75	Version
Order No.	9008370000	Screwdriver, Blade width (B): 2.5 mm, Blade length: 75 mm, Blade thickness (A): 0.4 mm
GTIN (EAN)	4032248056330	
Qty.	1 pc(s).	