

## OMNIMATE Signal - series BL/SL 5.08 SLF 5.08/10/180DF SN OR BX

**Weidmüller Interface GmbH & Co. KG**  
Klingenbergstraße 26  
D-32758 Detmold  
Germany  
Fon: +49 5231 14-0  
Fax: +49 5231 14-292083  
www.weidmueller.com

### Product image

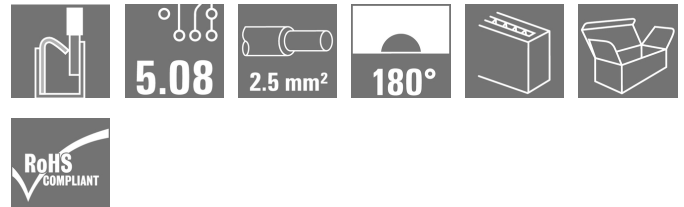
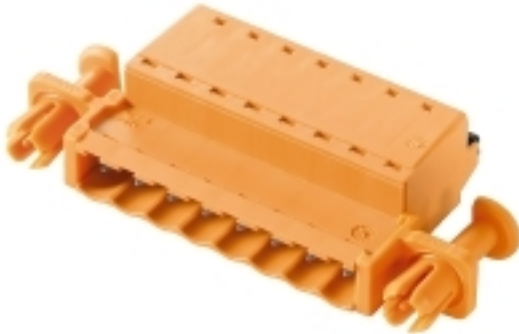

Similar to illustration

Male plug with PUSH IN wire connection and straight outlet direction, when used with BLF 5.08HC as wire-to-wire application for panel feed-through. The male plugs provide space for labelling and can be coded.

### General ordering data

Type	SLF 5.08/10/180DF SN OR BX
Order No.	<a href="#">1353680000</a>
Version	PCB plug-in connector, male plug, 5.08 mm, Number of poles: 10, 180°, PUSH IN, Spring connection, Clamping range, max. : 3.31 mm², Box
GTIN (EAN)	4050118156423
Qty.	24 pc(s).
Product data	IEC: 400 V / 25.9 A / 0.2 - 2.5 mm² UL: 300 V / 14 A / AWG 26 - AWG 12
Packaging	Box

Creation date May 3, 2020 6:26:41 AM CEST

**OMNIMATE Signal - series BL/SL 5.08  
SLF 5.08/10/180DF SN OR BX**

**Weidmüller Interface GmbH & Co. KG**  
Klingenbergstraße 26  
D-32758 Detmold  
Germany  
Fon: +49 5231 14-0  
Fax: +49 5231 14-292083  
www.weidmueller.com

**Technical data**
**Dimensions and weights**

Height	14.2 mm	Height (inches)	0.559 inch
Depth	31 mm	Depth (inches)	1.22 inch
Net weight	22.5 g		

**System Parameters**

Product family	OMNIMATE Signal - series BL/SL 5.08	Type of connection	Field connection
Wire connection method	PUSH IN, Spring connection	Pitch in mm (P)	5.08 mm
Pitch in inches (P)	0.2 inch	Conductor outlet direction	180°
Number of poles	10	L1 in mm	45.72 mm
L1 in inches	1.8 inch	Pin series quantity	1
Rated cross-section	2.5 mm <sup>2</sup>	Touch-safe protection acc. to DIN VDE 57 106	finger-safe plugged/ back-of-hand-safe unplugged
Volume resistance	4.50 mΩ	Can be coded	Yes
Stripping length	10 mm	Screwdriver blade	0.6 x 3.5
Screwdriver blade standard	DIN 5264	Plugging cycles	25
Plugging force/pole, max.	7 N	Pulling force/pole, max.	5.5 N

**Material data**

Insulating material	PBT	Colour	orange
Colour of operational elements	black	Colour chart (similar)	RAL 2000
Insulation strength	≥ 10 <sup>8</sup> Ω	UL 94 flammability rating	V-0
GWFI	960 °C	Contact material	CuSn
Contact surface	tinned	Layer structure of plug contact	4-8 μm Sn hot-dip tinned
Storage temperature, min.	-25 °C	Storage temperature, max.	50 °C
Max. relative humidity during storage	70 %	Operating temperature, min.	-50 °C
Operating temperature, max.	100 °C	Temperature range, installation, min.	-25 °C
Temperature range, installation, max.	100 °C		

**Conductors suitable for connection**

Clamping range, min.	0.13 mm <sup>2</sup>
Clamping range, max.	3.31 mm <sup>2</sup>
Wire connection cross section AWG, min.	AWG 26
Wire connection cross section AWG, max.	AWG 12
Solid, min. H05(07) V-U	0.2 mm <sup>2</sup>
Solid, max. H05(07) V-U	2.5 mm <sup>2</sup>
Flexible, min. H05(07) V-K	0.2 mm <sup>2</sup>
Flexible, max. H05(07) V-K	2.5 mm <sup>2</sup>
w. plastic collar ferrule, DIN 46228 pt 4, 0.2 mm <sup>2</sup> min.	
w. plastic collar ferrule, DIN 46228 pt 4, 2.5 mm <sup>2</sup> max.	
w. wire end ferrule, DIN 46228 pt 1, min.	0.2 mm <sup>2</sup>
w. wire end ferrule, DIN 46228 pt 1, max.	2.5 mm <sup>2</sup>
Plug gauge in accordance with EN 60999 a x b; ø	2.8 mm x 2.0 mm

Creation date May 3, 2020 6:26:41 AM CEST

**OMNIMATE Signal - series BL/SL 5.08  
SLF 5.08/10/180DF SN OR BX**

**Weidmüller Interface GmbH & Co. KG**  
Klingenbergstraße 26  
D-32758 Detmold  
Germany  
Fon: +49 5231 14-0  
Fax: +49 5231 14-292083  
www.weidmueller.com

**Technical data**

Clampable conductor	Cross-section for conductor connection	Type	fine-wired	
		nominal	0.5 mm <sup>2</sup>	
	wire end ferrule	Stripping length	nominal	12 mm
		Recommended wire-end ferrule	<a href="#">H0.5/16 OR</a>	
		Stripping length	nominal	10 mm
		Recommended wire-end ferrule	<a href="#">H0.5/10</a>	
	Cross-section for conductor connection	Type	fine-wired	
		nominal	0.75 mm <sup>2</sup>	
	wire end ferrule	Stripping length	nominal	12 mm
		Recommended wire-end ferrule	<a href="#">H0.75/16 W</a>	
		Stripping length	nominal	10 mm
		Recommended wire-end ferrule	<a href="#">H0.75/10</a>	
	Cross-section for conductor connection	Type	fine-wired	
		nominal	1 mm <sup>2</sup>	
	wire end ferrule	Stripping length	nominal	12 mm
		Recommended wire-end ferrule	<a href="#">H1.0/16D R</a>	
		Stripping length	nominal	10 mm
		Recommended wire-end ferrule	<a href="#">H1.0/10</a>	
	Cross-section for conductor connection	Type	fine-wired	
		nominal	1.5 mm <sup>2</sup>	
wire end ferrule	Stripping length	nominal	10 mm	
	Recommended wire-end ferrule	<a href="#">H1.5/10</a>		
	Stripping length	nominal	12 mm	
	Recommended wire-end ferrule	<a href="#">H1.5/16 R</a>		
Cross-section for conductor connection	Type	fine-wired		
	nominal	2.5 mm <sup>2</sup>		
wire end ferrule	Stripping length	nominal	10 mm	
	Recommended wire-end ferrule	<a href="#">H2.5/10</a>		
Reference text	The outside diameter of the plastic collar should not be larger than the pitch (P), Length of ferrules is to be chosen depending on the product and the rated voltage.			
Max. clamping range	3.31 mm <sup>2</sup>			

**Rated data acc. to IEC**

tested acc. to standard	IEC 60664-1, IEC 61984	Rated current, min. number of poles (Tu=20°C)	25.9 A
Rated current, max. number of poles (Tu=20°C)	21.7 A	Rated current, min. number of poles (Tu=40°C)	22.5 A
Rated current, max. number of poles (Tu=40°C)	18.5 A	Rated voltage for surge voltage class / pollution degree II/2	400 V
Rated voltage for surge voltage class / pollution degree III/2	320 V	Rated voltage for surge voltage class / pollution degree III/3	250 V
Rated impulse voltage for surge voltage class/ pollution degree II/2	4 kV	Rated impulse voltage for surge voltage class/ pollution degree III/2	4 kV
Rated impulse voltage for surge voltage class/ contamination degree III/3	4 kV	Short-time withstand current resistance	3 x 1s with 120 A

**OMNIMATE Signal - series BL/SL 5.08  
SLF 5.08/10/180DF SN OR BX**

**Weidmüller Interface GmbH & Co. KG**  
Klingenbergstraße 26  
D-32758 Detmold  
Germany  
Fon: +49 5231 14-0  
Fax: +49 5231 14-292083  
www.weidmueller.com

**Technical data**
**Rated data acc. to CSA**

Rated voltage (Use group B / CSA)	300 V	Rated voltage (Use group D / CSA)	300 V
Rated current (Use group B / CSA)	10 A	Rated current (Use group D / CSA)	10 A
Wire cross-section, AWG, min.	AWG 26	Wire cross-section, AWG, max.	AWG 12

**Rated data acc. to UL 1059**

Institute (cURus)		Certificate No. (cURus)	E60693
Rated voltage (Use group B / UL 1059)	300 V	Rated voltage (Use group D / UL 1059)	300 V
Rated current (Use group B / UL 1059)	14 A	Rated current (Use group D / UL 1059)	10 A
Wire cross-section, AWG, min.	AWG 26	Wire cross-section, AWG, max.	AWG 12
Reference to approval values	Specifications are maximum values, details - see approval certificate.		

**Packing**

Packaging	Box	VPE length	30 mm
VPE width	135 mm	VPE height	350 mm

**Classifications**

ETIM 6.0	EC002638	ETIM 7.0	EC002638
eClass 9.0	27-44-03-09	eClass 9.1	27-44-03-09
eClass 10.0	27-44-03-09		

**Notes**

Notes	<ul style="list-style-type: none"> <li>• Additional colours on request</li> <li>• Gold-plated contact surfaces on request</li> <li>• Rated current related to rated cross-section &amp; min. No. of poles.</li> <li>• Wire end ferrule without plastic collar to DIN 46228/1</li> <li>• Wire end ferrule with plastic collar to DIN 46228/4</li> <li>• P on drawing = pitch</li> <li>• Crimping shape "A" for wire end ferrules with PZ 6/5 crimping tool recommended.</li> <li>• The test point can only be used as potential-pickup point.</li> </ul>
IPC conformity	Conformity: The products are developed, manufactured and delivered according international recognized standards and norms and comply with the assured properties in the data sheet resp. fulfill decorative properties in accordance with IPC-A-610 "Class 2". Further claims on the products can be evaluated on request.

**Data sheet****OMNIMATE Signal - series BL/SL 5.08  
SLF 5.08/10/180DF SN OR BX****Weidmüller Interface GmbH & Co. KG**  
Klingenbergstraße 26  
D-32758 Detmold  
Germany  
Fon: +49 5231 14-0  
Fax: +49 5231 14-292083  
www.weidmueller.com**Technical data****Approvals**

Approvals



ROHS

Conform

**Downloads**Approval/Certificate/Document of  
Conformity[Declaration of the Manufacturer](#)

Brochure/Catalogue

[FL DRIVES EN](#)  
[MB DEVICE MANUF. EN](#)  
[FL DRIVES DE](#)  
[CAT 2 PORTFOLIOGUIDE EN](#)  
[FL BUILDING SAFETY EN](#)  
[FL APPL LED LIGHTING EN](#)  
[FL INDUSTR.CONTROLS EN](#)  
[FL MACHINE SAFETY EN](#)  
[FL HEATING ELECTR EN](#)  
[FL APPL INVERTER EN](#)  
[FL\\_BASE\\_STATION\\_EN](#)  
[FL ELEVATOR EN](#)  
[FL POWER SUPPLY EN](#)  
[FL 72H SAMPLE SER EN](#)  
[PO OMNIMATE EN](#)

White paper PUSH IN wire connection

[Download Whitepaper](#)

**OMNIMATE Signal - series BL/SL 5.08  
SLF 5.08/10/180DF SN OR BX**

**Weidmüller Interface GmbH & Co. KG**  
Klingenbergstraße 26  
D-32758 Detmold  
Germany  
Fon: +49 5231 14-0  
Fax: +49 5231 14-292083  
www.weidmueller.com

**Drawings**

**Dimensional drawing**

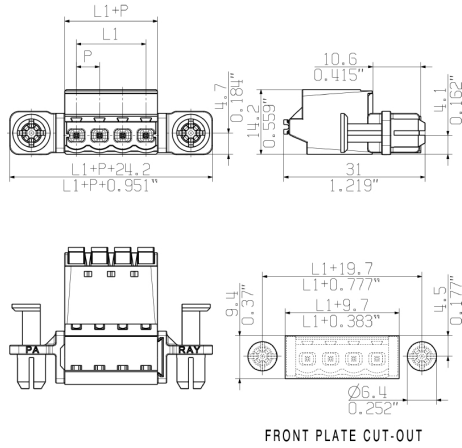

**Graph**

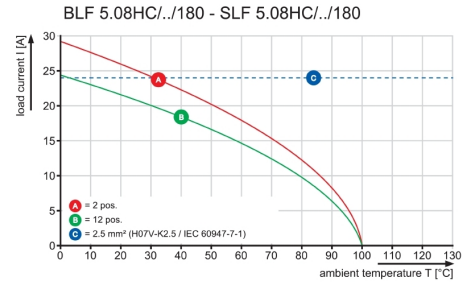

**Graph**

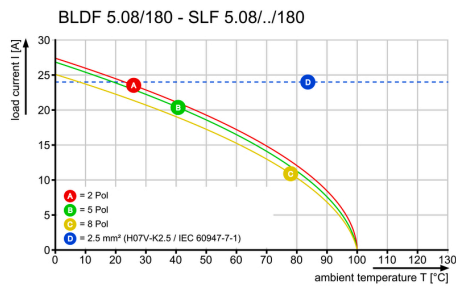

**Product benefits**



Uncompromising functionality  
High vibration resistance

**Product benefits**



Solid PUSH IN contact  
Safe and durable

**Product benefits**



Lower assembly costs  
Secure in a matter of seconds

**OMNIMATE Signal - series BL/SL 5.08  
SLF 5.08/10/180DF SN OR BX**

**Weidmüller Interface GmbH & Co. KG**  
Klingenbergstraße 26  
D-32758 Detmold  
Germany  
Fon: +49 5231 14-0  
Fax: +49 5231 14-292083  
www.weidmueller.com

**Mating connector (fully pluggable)**
**BLZP 5.08HC/225 SN**

Clamping-yoke connection with right-angled (90° or 270°) or angled (225°) outlet direction. The female connectors provide space for labelling and can be coded. Fastened by means of a flange or release latch. They also provide an integrated plus/minus screw, protection against faulty insertion of the wire, and they are delivered with open clamping yokes. HC = High Current.

**General ordering data**

Type	BLZP 5.08HC/10/225 SN B ...	Version	Product data	Packaging
Order No.	<a href="#">1946640000</a>	PCB plug-in connector, female plug, 5.08 mm, Number of poles: 10,	IEC: 400 V / 17.5 A / 0.2 - 4 mm <sup>2</sup>	Box
GTIN (EAN)	4032248622412	225°, Clamping yoke connection, Clamping range, max. : 4 mm <sup>2</sup> , Box	UL: 300 V / 15 A / AWG 26 - AWG 12	
Qty.	36 pc(s).			
Type	BLZP 5.08HC/10/225 SN O ...	Version	Product data	Packaging
Order No.	<a href="#">1946330000</a>	PCB plug-in connector, female plug, 5.08 mm, Number of poles: 10,	IEC: 400 V / 17.5 A / 0.2 - 4 mm <sup>2</sup>	Box
GTIN (EAN)	4032248621903	225°, Clamping yoke connection, Clamping range, max. : 4 mm <sup>2</sup> , Box	UL: 300 V / 15 A / AWG 26 - AWG 12	
Qty.	36 pc(s).			

**BLZP 5.08HC/270 SN**

Female plugs with clamping-yoke connection for connecting wires with a right-angle (90° or 270°) outlet direction. The female connectors provide space for labelling and can be coded. Fastened by means of a flange or release latch. They also provide an integrated plus/minus screw, protection against faulty insertion of the wire, and they are delivered with open clamping yokes. HC = High Current.

**General ordering data**

Type	BLZP 5.08HC/10/270 SN O ...	Version	Product data	Packaging
Order No.	<a href="#">1948870000</a>	PCB plug-in connector, female plug, 5.08 mm, Number of poles: 10,	IEC: 400 V / 23 A / 0.2 - 4 mm <sup>2</sup>	Box
GTIN (EAN)	4032248626328	270°, Clamping yoke connection, Clamping range, max. : 4 mm <sup>2</sup> , Box	UL: 300 V / 20 A / AWG 26 - AWG 12	
Qty.	36 pc(s).			
Type	BLZP 5.08HC/10/270 SN B ...	Version	Product data	Packaging
Order No.	<a href="#">1949100000</a>	PCB plug-in connector, female plug, 5.08 mm, Number of poles: 10,	IEC: 400 V / 23 A / 0.2 - 4 mm <sup>2</sup>	Box
GTIN (EAN)	4032248626557	270°, Clamping yoke connection, Clamping range, max. : 4 mm <sup>2</sup> , Box	UL: 300 V / 20 A / AWG 26 - AWG 12	
Qty.	36 pc(s).			

**OMNIMATE Signal - series BL/SL 5.08  
SLF 5.08/10/180DF SN OR BX**

**Weidmüller Interface GmbH & Co. KG**  
 Klingenbergstraße 26  
 D-32758 Detmold  
 Germany  
 Fon: +49 5231 14-0  
 Fax: +49 5231 14-292083  
 www.weidmueller.com

**Mating connector (fully pluggable)****BLZP 5.08HC/180 SN**

Female plug with clamping-yoke screw system for connecting wires with straight (180°) outlet direction. The female connectors provide space for labelling and can be coded. Fastened by means of a flange or release latch. They also provide an integrated plus/minus screw, protection against faulty insertion of the wire, and they are delivered with open clamping yokes. HC = High Current.

**General ordering data**

Type	BLZP 5.08HC/10/180 SN B ...	Version	Product data	Packaging
Order No.	<a href="#">1943890000</a>	PCB plug-in connector, female plug, 5.08 mm, Number of poles: 10,	IEC: 400 V / 23 A / 0.2 - 4 mm <sup>2</sup>	Box
GTIN (EAN)	4032248618002	180°, Clamping yoke connection, Clamping range, max. : 4 mm <sup>2</sup> , Box	UL: 300 V / 20 A / AWG 26 - AWG 12	
Qty.	36 pc(s).			
Type	BLZP 5.08HC/10/180 SN O ...	Version	Product data	Packaging
Order No.	<a href="#">1943660000</a>	PCB plug-in connector, female plug, 5.08 mm, Number of poles: 10,	IEC: 400 V / 23 A / 0.2 - 4 mm <sup>2</sup>	Box
GTIN (EAN)	4032248617678	180°, Clamping yoke connection, Clamping range, max. : 4 mm <sup>2</sup> , Box	UL: 300 V / 20 A / AWG 26 - AWG 12	
Qty.	36 pc(s).			

**BLF 5.08HC/180 SN**

Just as reliable as the millionfold proven original and featuring innovative details:  
 The BLF 5.08HC PUSH IN version of the BLZP 5.08HC female connector is not only different in terms of connection system; it also has a more compact design. Weidmüller's innovative PUSH IN spring connection system stands for the future of easy and tool-free wire connection. HC = High Current.  
 In terms of versatility, the BLF 5.08HC offers just as much as the version which served as a model:

- 3 tested-and-proven wire outlet directions provide the usual flexibility for application-specific design
- 4 flange variations and the patented release latch allow the locking concept to be based on the requirements of the user
- Use the BLF 5.08HC and SL 5.08HC plug combination to reach the max. rated specifications

**General ordering data**

Type	BLF 5.08HC/10/180 SN OR ...	Version	Product data	Packaging
Order No.	<a href="#">1013770000</a>	PCB plug-in connector, female plug, 5.08 mm, Number of poles: 10,	IEC: 400 V / 24 A / 0.2 - 2.5 mm <sup>2</sup>	Box
GTIN (EAN)	4032248721887	180°, PUSH IN, Spring connection, Clamping range, max. : 3.31 mm <sup>2</sup> , Box	UL: 300 V / 18.5 A / AWG 26 - AWG 12	
Qty.	36 pc(s).			
Type	BLF 5.08HC/10/180 SN BK ...	Version	Product data	Packaging
Order No.	<a href="#">1013520000</a>	PCB plug-in connector, female plug, 5.08 mm, Number of poles: 10,	IEC: 400 V / 24 A / 0.2 - 2.5 mm <sup>2</sup>	Box
GTIN (EAN)	4032248721665	180°, PUSH IN, Spring connection, Clamping range, max. : 3.31 mm <sup>2</sup> , Box	UL: 300 V / 18.5 A / AWG 26 - AWG 12	
Qty.	36 pc(s).			



**OMNIMATE Signal - series BL/SL 5.08  
SLF 5.08/10/180DF SN OR BX**

**Weidmüller Interface GmbH & Co. KG**  
Klingenbergstraße 26  
D-32758 Detmold  
Germany  
Fon: +49 5231 14-0  
Fax: +49 5231 14-292083  
www.weidmuller.com

**Mating connector (fully pluggable)**
**BLZP 5.08HC/90 SN**

Female plugs with clamping-yoke connection for connecting wires with a right-angle (90° or 270°) outlet direction. The female connectors provide space for labelling and can be coded. Fastened by means of a flange or release latch. They also provide an integrated plus/minus screw, protection against faulty insertion of the wire, and they are delivered with open clamping yokes. HC = High Current.

**General ordering data**

Type	BLZP 5.08HC/10/90 SN BK ...	Version	Product data	Packaging
Order No.	<a href="#">1948320000</a>	PCB plug-in connector, female plug, 5.08 mm, Number of poles: 10,	IEC: 400 V / 23 A / 0.2 - 4 mm <sup>2</sup>	Box
GTIN (EAN)	4032248624843	90°, Clamping yoke connection, Clamping range, max. : 4 mm <sup>2</sup> , Box	UL: 300 V / 20 A / AWG 26 - AWG 12	
Qty.	36 pc(s).			
Type	BLZP 5.08HC/10/90 SN OR ...	Version	Product data	Packaging
Order No.	<a href="#">1948080000</a>	PCB plug-in connector, female plug, 5.08 mm, Number of poles: 10,	IEC: 400 V / 23 A / 0.2 - 4 mm <sup>2</sup>	Box
GTIN (EAN)	4032248624300	90°, Clamping yoke connection, Clamping range, max. : 4 mm <sup>2</sup> , Box	UL: 300 V / 20 A / AWG 26 - AWG 12	
Qty.	36 pc(s).			

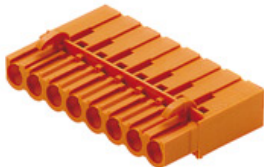
**BLC 5.08R**

Female plugs with crimp wire connection system. The female plugs provide space for labelling and can be coded.

**General ordering data**

Type	BLC 5.08/10/180R OR BX	Version	Product data	Packaging
Order No.	<a href="#">1610570000</a>	PCB plug-in connector, female plug, 5.08 mm, Number of poles: 10,	IEC: 400 V / 21 A	Box
GTIN (EAN)	4008190128180	180°, Crimp connection, Clamping range, max. : 2.5 mm <sup>2</sup> , Box	UL: 300 V / 10 A / AWG 26 - AWG 14	
Qty.	50 pc(s).			
Type	BLC 5.08/10/180R BK BX	Version	Product data	Packaging
Order No.	<a href="#">1712040000</a>	PCB plug-in connector, female plug, 5.08 mm, Number of poles: 10,	IEC: 400 V / 21 A	Box
GTIN (EAN)	4008190935054	180°, Crimp connection, Clamping range, max. : 2.5 mm <sup>2</sup> , Box	UL: 300 V / 10 A / AWG 26 - AWG 14	
Qty.	50 pc(s).			

**OMNIMATE Signal - series BL/SL 5.08  
SLF 5.08/10/180DF SN OR BX**

**Weidmüller Interface GmbH & Co. KG**  
Klingenbergstraße 26  
D-32758 Detmold  
Germany  
Fon: +49 5231 14-0  
Fax: +49 5231 14-292083  
www.weidmuller.com

**Mating connector (fully pluggable)**
**BLF 5.08HC/90 SN**

Just as reliable as the millionfold proven original and featuring innovative details:  
The BLF 5.08HC PUSH IN version of the BLZP 5.08HC female connector is not only different in terms of connection system; it also has a more compact design. Weidmüller's innovative PUSH IN spring connection system stands for the future of easy and tool-free wire connection. HC = High Current.  
In terms of versatility, the BLF 5.08HC offers just as much as the version which served as a model:

- 3 tested-and-proven wire outlet directions provide the usual flexibility for application-specific design
- 4 flange variations and the patented release latch allow the locking concept to be based on the requirements of the user
- Use the BLF 5.08HC and SL 5.08HC plug combination to reach the max. rated specifications

**General ordering data**

Type	BLF 5.08HC/10/90 SN BK ...	Version	Product data	Packaging
Order No.	<a href="#">1000110001</a>	PCB plug-in connector, female plug, 5.08 mm, Number of poles: 10,	IEC: 400 V / 24 A / 0.2 - 2.5 mm <sup>2</sup>	Box
GTIN (EAN)	4032248690046	90°, PUSH IN, Spring connection, Clamping range, max. : 3.31 mm <sup>2</sup> ,	UL: 300 V / 18.5 A / AWG 26 - AWG	
Qty.	36 pc(s).	Box	12	
Type	BLF 5.08HC/10/90 SN OR ...	Version	Product data	Packaging
Order No.	<a href="#">1001610000</a>	PCB plug-in connector, female plug, 5.08 mm, Number of poles: 10,	IEC: 400 V / 24 A / 0.2 - 2.5 mm <sup>2</sup>	Box
GTIN (EAN)	4032248693412	90°, PUSH IN, Spring connection, Clamping range, max. : 3.31 mm <sup>2</sup> ,	UL: 300 V / 18.5 A / AWG 26 - AWG	
Qty.	36 pc(s).	Box	12	

**BLDT 5.08**

Female plugs with two clamping-yoke screw connections per pole for wire connections with 90° and 270° outlet directions. The female plugs provide space for labelling and can be coded.

**General ordering data**

Type	BLDT 5.08/10/- SN BK BX	Version	Product data	Packaging
Order No.	<a href="#">1660790000</a>	PCB plug-in connector, female plug, 5.08 mm, Number of poles: 10,	IEC: 400 V / 14 A / 0.2 - 2.5 mm <sup>2</sup>	Box
GTIN (EAN)	4008190417246	180°, Clamping yoke connection, Clamping range, max. : 3.31 mm <sup>2</sup> ,	UL: 300 V / 10 A / AWG 26 - AWG 12	
Qty.	50 pc(s).	Box		
Type	BLDT 5.08/10/- SN OR BX	Version	Product data	Packaging
Order No.	<a href="#">1644810000</a>	PCB plug-in connector, female plug, 5.08 mm, Number of poles: 10,	IEC: 400 V / 14 A / 0.2 - 2.5 mm <sup>2</sup>	Box
GTIN (EAN)	4008190284022	180°, Clamping yoke connection, Clamping range, max. : 3.31 mm <sup>2</sup> ,	UL: 300 V / 10 A / AWG 26 - AWG 12	
Qty.	30 pc(s).	Box		

**OMNIMATE Signal - series BL/SL 5.08  
SLF 5.08/10/180DF SN OR BX**

**Weidmüller Interface GmbH & Co. KG**  
Klingenbergstraße 26  
D-32758 Detmold  
Germany  
Fon: +49 5231 14-0  
Fax: +49 5231 14-292083  
www.weidmuller.com

**Mating connector (fully pluggable)****BLF 5.08HC/270 SN**

Just as reliable as the millionfold proven original and featuring innovative details:

The BLF 5.08HC PUSH IN version of the BLZP 5.08HC female connector is not only different in terms of connection system; it also has a more compact design. Weidmüller's innovative PUSH IN spring connection system stands for the future of easy and tool-free wire connection. HC = High Current.

In terms of versatility, the BLF 5.08HC offers just as much as the version which served as a model:

- 3 tested-and-proven wire outlet directions provide the usual flexibility for application-specific design
- 4 flange variations and the patented release latch allow the locking concept to be based on the requirements of the user
- Use the BLF 5.08HC and SL 5.08HC plug combination to reach the max. rated specifications

**General ordering data**

Type	BLF 5.08HC/10/270 SN BK ...	Version	Product data	Packaging
Order No.	<a href="#">1982010000</a>	PCB plug-in connector, female plug, 5.08 mm, Number of poles: 10,	IEC: 400 V / 24 A / 0.2 - 2.5 mm <sup>2</sup>	Box
GTIN (EAN)	4032248684700	270°, PUSH IN, Spring connection, Clamping range, max. : 3.31 mm <sup>2</sup> ,	UL: 300 V / 18.5 A / AWG 26 - AWG	
Qty.	36 pc(s).	Box	12	
Type	BLF 5.08HC/10/270 SN OR ...	Version	Product data	Packaging
Order No.	<a href="#">1982780000</a>	PCB plug-in connector, female plug, 5.08 mm, Number of poles: 10,	IEC: 400 V / 24 A / 0.2 - 2.5 mm <sup>2</sup>	Box
GTIN (EAN)	4032248686872	270°, PUSH IN, Spring connection, Clamping range, max. : 3.31 mm <sup>2</sup> ,	UL: 300 V / 18.5 A / AWG 26 - AWG	
Qty.	36 pc(s).	Box	12	

**BLZP 5.08HC/225B SN**

Clamping-yoke connection with right-angled (90° or 270°) or angled (225°) outlet direction. The female connectors provide space for labelling and can be coded. Fastened by means of a flange or release latch. They also provide an integrated plus/minus screw, protection against faulty insertion of the wire, and they are delivered with open clamping yokes. HC = High Current.

**General ordering data**

Type	BLZP 5.08HC/10/225B SN ...	Version	Product data	Packaging
Order No.	<a href="#">1945830000</a>	PCB plug-in connector, female plug, 5.08 mm, Number of poles: 10,	IEC: 400 V / 17.5 A / 0.2 - 4 mm <sup>2</sup>	Box
GTIN (EAN)	4032248621309	225°, Clamping yoke connection, Clamping range, max. : 4 mm <sup>2</sup> , Box	UL: 300 V / 15 A / AWG 26 - AWG 12	
Qty.	30 pc(s).			
Type	BLZP 5.08HC/10/225B SN ...	Version	Product data	Packaging
Order No.	<a href="#">1946060000</a>	PCB plug-in connector, female plug, 5.08 mm, Number of poles: 10,	IEC: 400 V / 17.5 A / 0.2 - 4 mm <sup>2</sup>	Box
GTIN (EAN)	4032248621590	225°, Clamping yoke connection, Clamping range, max. : 4 mm <sup>2</sup> , Box	UL: 300 V / 15 A / AWG 26 - AWG 12	
Qty.	30 pc(s).			

**OMNIMATE Signal - series BL/SL 5.08  
SLF 5.08/10/180DF SN OR BX**

**Weidmüller Interface GmbH & Co. KG**  
Klingenbergstraße 26  
D-32758 Detmold  
Germany  
Fon: +49 5231 14-0  
Fax: +49 5231 14-292083  
www.weidmueller.com

**Mating connector (fully pluggable)**
**BLL 5.08/180**

Female header for PCB mounting. The solder pin length is optimised for wave flow soldering.

**General ordering data**

Type	BLL 5.08/10/180 3.2 SN ...	Version	Product data	Packaging
Order No.	<a href="#">1630790000</a>	PCB plug-in connector, female header, closed side, THT solder	IEC: 400 V / 23 A	Box
GTIN (EAN)	4008190204228	connection, 5.08 mm, Number of poles: 10, 180°, Solder pin length	UL: 300 V / 15 A	
Qty.	36 pc(s).	(I): 3.2 mm, tinned, orange, Box		

**BLL 5.08/90**

Female header for PCB mounting. The solder pin length is optimised for wave flow soldering.

**General ordering data**

Type	BLL 5.08/10/90 3.2 SN O ...	Version	Product data	Packaging
Order No.	<a href="#">1623020000</a>	PCB plug-in connector, female header, closed side, THT solder	IEC: 400 V / 23 A	Box
GTIN (EAN)	4008190194079	connection, 5.08 mm, Number of poles: 10, 90°, Solder pin length (I):	UL: 300 V / 15 A	
Qty.	36 pc(s).	3.2 mm, tinned, orange, Box		

**OMNIMATE Signal - series BL/SL 5.08  
SLF 5.08/10/180DF SN OR BX**

**Weidmüller Interface GmbH & Co. KG**  
Klingenbergstraße 26  
D-32758 Detmold  
Germany  
Fon: +49 5231 14-0  
Fax: +49 5231 14-292083  
www.weidmueller.com

**Mating connector (fully pluggable)**
**BLDT 5.08B**

Female plugs with two clamping-yoke screw connections per pole for wire connections with 90° and 270° outlet directions. The female plugs provide space for labelling and can be coded.

**General ordering data**

Type	BLDT 5.08/10/-B SN OR BX	Version	Product data	Packaging
Order No.	<a href="#">1651820000</a>	PCB plug-in connector, female plug, 5.08 mm, Number of poles: 10,	IEC: 400 V / 14 A / 0.2 - 2.5 mm <sup>2</sup>	Box
GTIN (EAN)	4008190400507	180°, Clamping yoke connection, Clamping range, max. : 3.31 mm <sup>2</sup> ,	UL: 300 V / 10 A / AWG 26 - AWG 12	
Qty.	25 pc(s).	Box		
Type	BLDT 5.08/10/-B SN BK BX	Version	Product data	Packaging
Order No.	<a href="#">1673860000</a>	PCB plug-in connector, female plug, 5.08 mm, Number of poles: 10,	IEC: 400 V / 14 A / 0.2 - 2.5 mm <sup>2</sup>	Box
GTIN (EAN)	4008190435592	180°, Clamping yoke connection, Clamping range, max. : 3.31 mm <sup>2</sup> ,	UL: 300 V / 10 A / AWG 26 - AWG 12	
Qty.	50 pc(s).	Box		

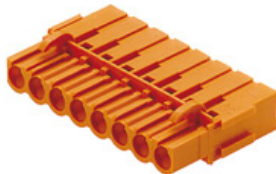
**BLC 5.08BR**

Female plugs with crimp wire connection system. The female plugs provide space for labelling and can be coded.

**General ordering data**

Type	BLC 5.08/10/180BR OR BX	Version	Product data	Packaging
Order No.	<a href="#">1649450000</a>	PCB plug-in connector, female plug, 5.08 mm, Number of poles: 10,	IEC: 400 V / 21 A	Box
GTIN (EAN)	4008190294564	180°, Crimp connection, Clamping range, max. : 2.5 mm <sup>2</sup> , Box	UL: 300 V / 10 A / AWG 26 - AWG 14	
Qty.	50 pc(s).			
Type	BLC 5.08/10/180BR BK BX	Version	Product data	Packaging
Order No.	<a href="#">1712190000</a>	PCB plug-in connector, female plug, 5.08 mm, Number of poles: 10,	IEC: 400 V / 21 A	Box
GTIN (EAN)	4008190935207	180°, Crimp connection, Clamping range, max. : 2.5 mm <sup>2</sup> , Box	UL: 300 V / 10 A / AWG 26 - AWG 14	
Qty.	50 pc(s).			

**OMNIMATE Signal - series BL/SL 5.08  
SLF 5.08/10/180DF SN OR BX**

**Weidmüller Interface GmbH & Co. KG**  
Klingenbergstraße 26  
D-32758 Detmold  
Germany  
Fon: +49 5231 14-0  
Fax: +49 5231 14-292083  
www.weidmueller.com

**Mating connector (fully pluggable)**

**BLL 5.08/180B**



Female header for PCB mounting. The solder pin length is optimised for wave flow soldering.

**General ordering data**

Type	BLL 5.08/10/180B 3.2SN ...	Version	Product data	Packaging
Order No.	<a href="#">1682810000</a>	PCB plug-in connector, female header, Dovetails for fixing blocks, THT	IEC: 400 V / 23 A	Box
GTIN (EAN)	4008190474577	solder connection, 5.08 mm, Number of poles: 10, 180°, Solder pin	UL: 300 V / 15 A	
Qty.	30 pc(s).	length (l): 3.2 mm, tinned, orange, Box		

**Data sheet****OMNIMATE Signal - series BL/SL 5.08  
SLF 5.08/10/180DF SN OR BX**

**Weidmüller Interface GmbH & Co. KG**  
Klingenbergstraße 26  
D-32758 Detmold  
Germany  
Fon: +49 5231 14-0  
Fax: +49 5231 14-292083  
[www.weidmueller.com](http://www.weidmueller.com)

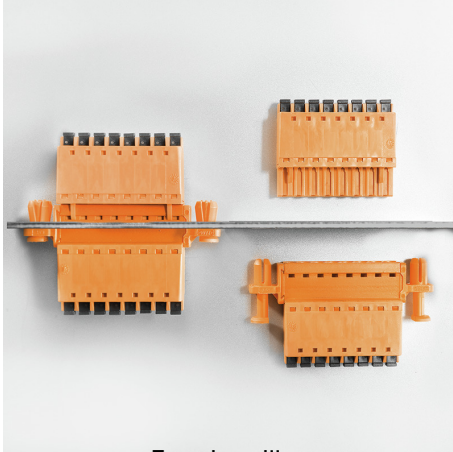
**Drawings****Product benefits**

Easy handling  
No implementation framework necessary