

OMNIMATE Signal - series BL/SL 5.08 SLF 5.08/10/180B SN BK BX

Weidmüller Interface GmbH & Co. KG
Klingenbergstraße 26
D-32758 Detmold
Germany
Fon: +49 5231 14-0
Fax: +49 5231 14-292083
www.weidmueller.com

Product image

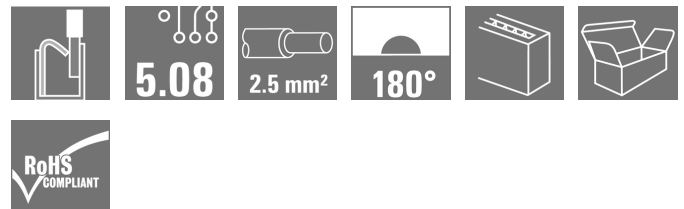

Similar to illustration

Male plug with PUSH IN wire connection and straight outlet direction, when used with BLF 5.08HC as wire-to-wire application for panel feed-through. The male plugs provide space for labelling and can be coded.

General ordering data

Type	SLF 5.08/10/180B SN BK BX
Order No.	1335940000
Version	PCB plug-in connector, male plug, 5.08 mm, Number of poles: 10, 180°, PUSH IN, Spring connection, Clamping range, max. : 3.31 mm², Box
GTIN (EAN)	4050118138993
Qty.	30 pc(s).
Product data	IEC: 400 V / 25.9 A / 0.2 - 2.5 mm² UL: 300 V / 14 A / AWG 26 - AWG 12
Packaging	Box

Creation date May 3, 2020 3:47:09 AM CEST

**OMNIMATE Signal - series BL/SL 5.08
SLF 5.08/10/180B SN BK BX**

Weidmüller Interface GmbH & Co. KG
 Klingenbergstraße 26
 D-32758 Detmold
 Germany
 Fon: +49 5231 14-0
 Fax: +49 5231 14-292083
 www.weidmueller.com

Technical data**Dimensions and weights**

Height	14.2 mm	Height (inches)	0.559 inch
Depth	30 mm	Depth (inches)	1.181 inch
Net weight	20.43 g		

System Parameters

Product family	OMNIMATE Signal - series BL/SL 5.08	Type of connection	Field connection
Wire connection method	PUSH IN, Spring connection	Pitch in mm (P)	5.08 mm
Pitch in inches (P)	0.2 inch	Conductor outlet direction	180°
Number of poles	10	L1 in mm	45.72 mm
L1 in inches	1.8 inch	Pin series quantity	1
Rated cross-section	2.5 mm ²	Touch-safe protection acc. to DIN VDE 57 106	finger-safe plugged/ back-of-hand-safe unplugged
Volume resistance	4.50 mΩ	Can be coded	Yes
Stripping length	10 mm	Screwdriver blade	0.6 x 3.5
Screwdriver blade standard	DIN 5264	Plugging cycles	25
Plugging force/pole, max.	7 N	Pulling force/pole, max.	5.5 N

Material data

Insulating material	PBT	Colour	black
Colour of operational elements	orange	Material of operational elements	PBT
Colour chart (similar)	RAL 9011	Insulation strength	≥ 10 ⁸ Ω
UL 94 flammability rating	V-0	GWFI	960 °C
Contact material	CuSn	Contact surface	tinned
Layer structure of plug contact	4-8 μm Sn hot-dip tinned	Storage temperature, min.	-25 °C
Storage temperature, max.	50 °C	Max. relative humidity during storage	70 %
Operating temperature, min.	-50 °C	Operating temperature, max.	100 °C
Temperature range, installation, min.	-25 °C	Temperature range, installation, max.	100 °C

Conductors suitable for connection

Clamping range, min.	0.13 mm ²
Clamping range, max.	3.31 mm ²
Wire connection cross section AWG, min.	AWG 26
Wire connection cross section AWG, max.	AWG 12
Solid, min. H05(07) V-U	0.2 mm ²
Solid, max. H05(07) V-U	2.5 mm ²
Flexible, min. H05(07) V-K	0.2 mm ²
Flexible, max. H05(07) V-K	2.5 mm ²
w. plastic collar ferrule, DIN 46228 pt 4, 0.2 mm ² min.	
w. plastic collar ferrule, DIN 46228 pt 4, 2.5 mm ² max.	
w. wire end ferrule, DIN 46228 pt 1, min.	0.2 mm ²
w. wire end ferrule, DIN 46228 pt 1, max.	2.5 mm ²
Plug gauge in accordance with EN 60999 a x b; ø	2.8 mm x 2.0 mm

Creation date May 3, 2020 3:47:09 AM CEST

OMNIMATE Signal - series BL/SL 5.08
SLF 5.08/10/180B SN BK BX

Weidmüller Interface GmbH & Co. KG
 Klingenbergstraße 26
 D-32758 Detmold
 Germany
 Fon: +49 5231 14-0
 Fax: +49 5231 14-292083
 www.weidmueller.com

Technical data

Clampable conductor	Cross-section for conductor connection	Type	fine-wired	
		nominal	0.5 mm ²	
	wire end ferrule	Stripping length	nominal	12 mm
		Recommended wire-end ferrule	H0.5/16 OR	
		Stripping length	nominal	10 mm
		Recommended wire-end ferrule	H0.5/10	
	Cross-section for conductor connection	Type	fine-wired	
		nominal	0.75 mm ²	
	wire end ferrule	Stripping length	nominal	12 mm
		Recommended wire-end ferrule	H0.75/16 W	
		Stripping length	nominal	10 mm
		Recommended wire-end ferrule	H0.75/10	
	Cross-section for conductor connection	Type	fine-wired	
		nominal	1 mm ²	
	wire end ferrule	Stripping length	nominal	12 mm
		Recommended wire-end ferrule	H1.0/16D R	
		Stripping length	nominal	10 mm
		Recommended wire-end ferrule	H1.0/10	
	Cross-section for conductor connection	Type	fine-wired	
		nominal	1.5 mm ²	
wire end ferrule	Stripping length	nominal	10 mm	
	Recommended wire-end ferrule	H1.5/10		
	Stripping length	nominal	12 mm	
	Recommended wire-end ferrule	H1.5/16 R		
Cross-section for conductor connection	Type	fine-wired		
	nominal	2.5 mm ²		
wire end ferrule	Stripping length	nominal	10 mm	
	Recommended wire-end ferrule	H2.5/10		
Reference text	The outside diameter of the plastic collar should not be larger than the pitch (P). Length of ferrules is to be chosen depending on the product and the rated voltage.			
Max. clamping range	3.31 mm ²			

Rated data acc. to IEC

tested acc. to standard	IEC 60664-1, IEC 61984	Rated current, min. number of poles (Tu=20°C)	25.9 A
Rated current, max. number of poles (Tu=20°C)	21.7 A	Rated current, min. number of poles (Tu=40°C)	22.5 A
Rated current, max. number of poles (Tu=40°C)	18.5 A	Rated voltage for surge voltage class / pollution degree II/2	400 V
Rated voltage for surge voltage class / pollution degree III/2	320 V	Rated voltage for surge voltage class / pollution degree III/3	250 V
Rated impulse voltage for surge voltage class/ pollution degree II/2	4 kV	Rated impulse voltage for surge voltage class/ pollution degree III/2	4 kV
Rated impulse voltage for surge voltage class/ contamination degree III/3	4 kV	Short-time withstand current resistance	3 x 1s with 120 A

**OMNIMATE Signal - series BL/SL 5.08
SLF 5.08/10/180B SN BK BX**

Weidmüller Interface GmbH & Co. KG
Klingenbergstraße 26
D-32758 Detmold
Germany
Fon: +49 5231 14-0
Fax: +49 5231 14-292083
www.weidmueller.com

Technical data**Rated data acc. to CSA**

Institute (CSA)		Certificate No. (CSA)	200039-1121690
Rated voltage (Use group B / CSA)	300 V	Rated voltage (Use group D / CSA)	300 V
Rated current (Use group B / CSA)	10 A	Rated current (Use group D / CSA)	10 A
Wire cross-section, AWG, min.	AWG 26	Wire cross-section, AWG, max.	AWG 12
Reference to approval values	Specifications are maximum values, details - see approval certificate.		

Rated data acc. to UL 1059

Institute (cURus)		Certificate No. (cURus)	E60693
Rated voltage (Use group B / UL 1059)	300 V	Rated voltage (Use group D / UL 1059)	300 V
Rated current (Use group B / UL 1059)	14 A	Rated current (Use group D / UL 1059)	10 A
Wire cross-section, AWG, min.	AWG 26	Wire cross-section, AWG, max.	AWG 12
Reference to approval values	Specifications are maximum values, details - see approval certificate.		

Packing

Packaging	Box	VPE length	40 mm
VPE width	140 mm	VPE height	350 mm

Classifications

ETIM 6.0	EC002638	ETIM 7.0	EC002638
eClass 9.0	27-44-03-09	eClass 9.1	27-44-03-09
eClass 10.0	27-44-03-09		

Notes

Notes	<ul style="list-style-type: none"> • Additional colours on request • Gold-plated contact surfaces on request • Rated current related to rated cross-section & min. No. of poles. • Wire end ferrule without plastic collar to DIN 46228/1 • Wire end ferrule with plastic collar to DIN 46228/4 • P on drawing = pitch • Crimping shape "A" for wire end ferrules with PZ 6/5 crimping tool recommended. • The test point can only be used as potential-pickup point.
IPC conformity	Conformity: The products are developed, manufactured and delivered according international recognized standards and norms and comply with the assured properties in the data sheet resp. fulfill decorative properties in accordance with IPC-A-610 "Class 2". Further claims on the products can be evaluated on request.

Creation date May 3, 2020 3:47:09 AM CEST

Data sheet**OMNIMATE Signal - series BL/SL 5.08
SLF 5.08/10/180B SN BK BX****Weidmüller Interface GmbH & Co. KG**
Klingenbergstraße 26
D-32758 Detmold
Germany
Fon: +49 5231 14-0
Fax: +49 5231 14-292083
www.weidmueller.com**Technical data****Approvals**

Approvals



ROHS

Conform

DownloadsApproval/Certificate/Document of
Conformity[Declaration of the Manufacturer](#)

Brochure/Catalogue

[FL DRIVES EN](#)
[MB DEVICE MANUF. EN](#)
[FL DRIVES DE](#)
[CAT 2 PORTFOLIOGUIDE EN](#)
[FL BUILDING SAFETY EN](#)
[FL APPL LED LIGHTING EN](#)
[FL INDUSTR.CONTROLS EN](#)
[FL MACHINE SAFETY EN](#)
[FL HEATING ELECTR EN](#)
[FL APPL INVERTER EN](#)
[FL_BASE_STATION_EN](#)
[FL ELEVATOR EN](#)
[FL POWER SUPPLY EN](#)
[FL 72H SAMPLE SER EN](#)
[PO OMNIMATE EN](#)

White paper PUSH IN wire connection

[Download Whitepaper](#)

**OMNIMATE Signal - series BL/SL 5.08
SLF 5.08/10/180B SN BK BX**

Weidmüller Interface GmbH & Co. KG
Klingenbergstraße 26
D-32758 Detmold
Germany
Fon: +49 5231 14-0
Fax: +49 5231 14-292083
www.weidmueller.com

Drawings

Dimensional drawing

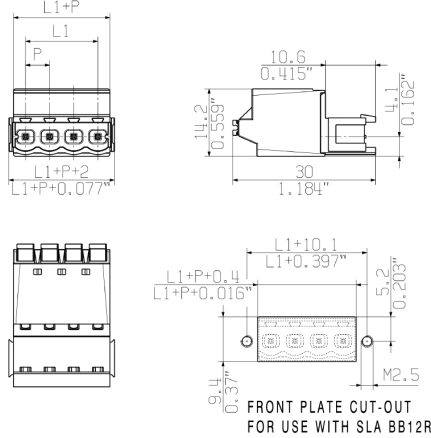

Graph

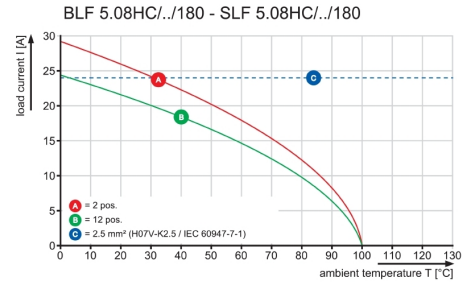

Graph

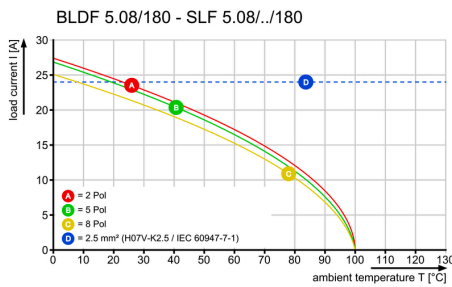

Product benefits



Uncompromising functionality
High vibration resistance

Product benefits



Solid PUSH IN contact
Safe and durable

Product benefits



Lower assembly costs
Secure in a matter of seconds

**OMNIMATE Signal - series BL/SL 5.08
SLF 5.08/10/180B SN BK BX**

Weidmüller Interface GmbH & Co. KG
Klingenbergstraße 26
D-32758 Detmold
Germany
Fon: +49 5231 14-0
Fax: +49 5231 14-292083
www.weidmueller.com

Mating connector (fully pluggable)
BLZP 5.08HC/225 SN

Clamping-yoke connection with right-angled (90° or 270°) or angled (225°) outlet direction. The female connectors provide space for labelling and can be coded. Fastened by means of a flange or release latch. They also provide an integrated plus/minus screw, protection against faulty insertion of the wire, and they are delivered with open clamping yokes. HC = High Current.

General ordering data

Type	BLZP 5.08HC/10/225 SN B ...	Version	Product data	Packaging
Order No.	1946640000	PCB plug-in connector, female plug, 5.08 mm, Number of poles: 10,	IEC: 400 V / 17.5 A / 0.2 - 4 mm ²	Box
GTIN (EAN)	4032248622412	225°, Clamping yoke connection, Clamping range, max. : 4 mm ² , Box	UL: 300 V / 15 A / AWG 26 - AWG 12	
Qty.	36 pc(s).			
Type	BLZP 5.08HC/10/225 SN O ...	Version	Product data	Packaging
Order No.	1946330000	PCB plug-in connector, female plug, 5.08 mm, Number of poles: 10,	IEC: 400 V / 17.5 A / 0.2 - 4 mm ²	Box
GTIN (EAN)	4032248621903	225°, Clamping yoke connection, Clamping range, max. : 4 mm ² , Box	UL: 300 V / 15 A / AWG 26 - AWG 12	
Qty.	36 pc(s).			

BLZP 5.08HC/270 SN

Female plugs with clamping-yoke connection for connecting wires with a right-angle (90° or 270°) outlet direction. The female connectors provide space for labelling and can be coded. Fastened by means of a flange or release latch. They also provide an integrated plus/minus screw, protection against faulty insertion of the wire, and they are delivered with open clamping yokes. HC = High Current.

General ordering data

Type	BLZP 5.08HC/10/270 SN O ...	Version	Product data	Packaging
Order No.	1948870000	PCB plug-in connector, female plug, 5.08 mm, Number of poles: 10,	IEC: 400 V / 23 A / 0.2 - 4 mm ²	Box
GTIN (EAN)	4032248626328	270°, Clamping yoke connection, Clamping range, max. : 4 mm ² , Box	UL: 300 V / 20 A / AWG 26 - AWG 12	
Qty.	36 pc(s).			
Type	BLZP 5.08HC/10/270 SN B ...	Version	Product data	Packaging
Order No.	1949100000	PCB plug-in connector, female plug, 5.08 mm, Number of poles: 10,	IEC: 400 V / 23 A / 0.2 - 4 mm ²	Box
GTIN (EAN)	4032248626557	270°, Clamping yoke connection, Clamping range, max. : 4 mm ² , Box	UL: 300 V / 20 A / AWG 26 - AWG 12	
Qty.	36 pc(s).			

**OMNIMATE Signal - series BL/SL 5.08
SLF 5.08/10/180B SN BK BX**

Weidmüller Interface GmbH & Co. KG
Klingenbergstraße 26
D-32758 Detmold
Germany
Fon: +49 5231 14-0
Fax: +49 5231 14-292083
www.weidmueller.com

Mating connector (fully pluggable)
BLF 5.08HC/180DF SN

Just as reliable as the millionfold proven original and featuring innovative details:
The BLF 5.08HC PUSH IN version of the BLZP 5.08HC female connector is not only different in terms of connection system; it also has a more compact design. Weidmüller's innovative PUSH IN spring connection system stands for the future of easy and tool-free wire connection. HC = High Current.
In terms of versatility, the BLF 5.08HC offers just as much as the version which served as a model:

- 3 tested-and-proven wire outlet directions provide the usual flexibility for application-specific design
- 4 flange variations and the patented release latch allow the locking concept to be based on the requirements of the user
- Use the BLF 5.08HC and SL 5.08HC plug combination to reach the max. rated specifications

General ordering data

Type	BLF 5.08HC/10/180DF SN ...	Version	Product data	Packaging
Order No.	1353330000	PCB plug-in connector, female plug, 5.08 mm, Number of poles: 10,	IEC: 400 V / 24 A / 0.2 - 2.5 mm ²	Box
GTIN (EAN)	4050118155754	180°, PUSH IN, Spring connection, Clamping range, max. : 3.31 mm ² , UL: 300 V / 18.5 A / AWG 26 - AWG		
Qty.	24 pc(s).	Box	12	

BLZP 5.08HC/180 SN

Female plug with clamping-yoke screw system for connecting wires with straight (180°) outlet direction. The female connectors provide space for labelling and can be coded. Fastened by means of a flange or release latch. They also provide an integrated plus/minus screw, protection against faulty insertion of the wire, and they are delivered with open clamping yokes. HC = High Current.

General ordering data

Type	BLZP 5.08HC/10/180 SN B ...	Version	Product data	Packaging
Order No.	1943890000	PCB plug-in connector, female plug, 5.08 mm, Number of poles: 10,	IEC: 400 V / 23 A / 0.2 - 4 mm ²	Box
GTIN (EAN)	4032248618002	180°, Clamping yoke connection, Clamping range, max. : 4 mm ² , Box	UL: 300 V / 20 A / AWG 26 - AWG 12	
Qty.	36 pc(s).			
Type	BLZP 5.08HC/10/180 SN O ...	Version	Product data	Packaging
Order No.	1943660000	PCB plug-in connector, female plug, 5.08 mm, Number of poles: 10,	IEC: 400 V / 23 A / 0.2 - 4 mm ²	Box
GTIN (EAN)	4032248617678	180°, Clamping yoke connection, Clamping range, max. : 4 mm ² , Box	UL: 300 V / 20 A / AWG 26 - AWG 12	
Qty.	36 pc(s).			

**OMNIMATE Signal - series BL/SL 5.08
SLF 5.08/10/180B SN BK BX**

Weidmüller Interface GmbH & Co. KG
Klingenbergstraße 26
D-32758 Detmold
Germany
Fon: +49 5231 14-0
Fax: +49 5231 14-292083
www.weidmueller.com

Mating connector (fully pluggable)
BLF 5.08HC/180 SN

Just as reliable as the millionfold proven original and featuring innovative details:

The BLF 5.08HC PUSH IN version of the BLZP 5.08HC female connector is not only different in terms of connection system; it also has a more compact design. Weidmüller's innovative PUSH IN spring connection system stands for the future of easy and tool-free wire connection. HC = High Current.

In terms of versatility, the BLF 5.08HC offers just as much as the version which served as a model:

- 3 tested-and-proven wire outlet directions provide the usual flexibility for application-specific design
- 4 flange variations and the patented release latch allow the locking concept to be based on the requirements of the user
- Use the BLF 5.08HC and SL 5.08HC plug combination to reach the max. rated specifications

General ordering data

Type	BLF 5.08HC/10/180 SN OR ...	Version	Product data	Packaging
Order No.	1013770000	PCB plug-in connector, female plug, 5.08 mm, Number of poles: 10,	IEC: 400 V / 24 A / 0.2 - 2.5 mm ²	Box
GTIN (EAN)	4032248721887	180°, PUSH IN, Spring connection, Clamping range, max. : 3.31 mm ² ,	UL: 300 V / 18.5 A / AWG 26 - AWG	
Qty.	36 pc(s).	Box	12	
Type	BLF 5.08HC/10/180 SN BK ...	Version	Product data	Packaging
Order No.	1013520000	PCB plug-in connector, female plug, 5.08 mm, Number of poles: 10,	IEC: 400 V / 24 A / 0.2 - 2.5 mm ²	Box
GTIN (EAN)	4032248721665	180°, PUSH IN, Spring connection, Clamping range, max. : 3.31 mm ² ,	UL: 300 V / 18.5 A / AWG 26 - AWG	
Qty.	36 pc(s).	Box	12	

BLZP 5.08HC/90 SN



Female plugs with clamping-yoke connection for connecting wires with a right-angle (90° or 270°) outlet direction. The female connectors provide space for labelling and can be coded. Fastened by means of a flange or release latch. They also provide an integrated plus/minus screw, protection against faulty insertion of the wire, and they are delivered with open clamping yokes. HC = High Current.

General ordering data

Type	BLZP 5.08HC/10/90 SN BK ...	Version	Product data	Packaging
Order No.	1948320000	PCB plug-in connector, female plug, 5.08 mm, Number of poles: 10,	IEC: 400 V / 23 A / 0.2 - 4 mm ²	Box
GTIN (EAN)	4032248624843	90°, Clamping yoke connection, Clamping range, max. : 4 mm ² ,	UL: 300 V / 20 A / AWG 26 - AWG 12	
Qty.	36 pc(s).			
Type	BLZP 5.08HC/10/90 SN OR ...	Version	Product data	Packaging
Order No.	1948080000	PCB plug-in connector, female plug, 5.08 mm, Number of poles: 10,	IEC: 400 V / 23 A / 0.2 - 4 mm ²	Box
GTIN (EAN)	4032248624300	90°, Clamping yoke connection, Clamping range, max. : 4 mm ² ,	UL: 300 V / 20 A / AWG 26 - AWG 12	
Qty.	36 pc(s).			

**OMNIMATE Signal - series BL/SL 5.08
SLF 5.08/10/180B SN BK BX**

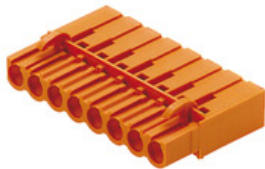
Weidmüller Interface GmbH & Co. KG
Klingenbergstraße 26
D-32758 Detmold
Germany
Fon: +49 5231 14-0
Fax: +49 5231 14-292083
www.weidmuller.com

Mating connector (fully pluggable)
BLC 5.08R

Female plugs with crimp wire connection system. The female plugs provide space for labelling and can be coded.

General ordering data

Type	BLC 5.08/10/180R OR BX	Version	Product data	Packaging
Order No.	1610570000	PCB plug-in connector, female plug, 5.08 mm, Number of poles: 10,	IEC: 400 V / 21 A	Box
GTIN (EAN)	4008190128180	180°, Crimp connection, Clamping range, max. : 2.5 mm ² , Box	UL: 300 V / 10 A / AWG 26 - AWG 14	
Qty.	50 pc(s).			
Type	BLC 5.08/10/180R BK BX	Version	Product data	Packaging
Order No.	1712040000	PCB plug-in connector, female plug, 5.08 mm, Number of poles: 10,	IEC: 400 V / 21 A	Box
GTIN (EAN)	4008190935054	180°, Crimp connection, Clamping range, max. : 2.5 mm ² , Box	UL: 300 V / 10 A / AWG 26 - AWG 14	
Qty.	50 pc(s).			

BLF 5.08HC/90 SN

Just as reliable as the millionfold proven original and featuring innovative details:
The BLF 5.08HC PUSH IN version of the BLZP 5.08HC female connector is not only different in terms of connection system; it also has a more compact design. Weidmüller's innovative PUSH IN spring connection system stands for the future of easy and tool-free wire connection. HC = High Current.
In terms of versatility, the BLF 5.08HC offers just as much as the version which served as a model:

- 3 tested-and-proven wire outlet directions provide the usual flexibility for application-specific design
- 4 flange variations and the patented release latch allow the locking concept to be based on the requirements of the user
- Use the BLF 5.08HC and SL 5.08HC plug combination to reach the max. rated specifications

General ordering data

Type	BLF 5.08HC/10/90 SN BK ...	Version	Product data	Packaging
Order No.	1000110001	PCB plug-in connector, female plug, 5.08 mm, Number of poles: 10,	IEC: 400 V / 24 A / 0.2 - 2.5 mm ²	Box
GTIN (EAN)	4032248690046	90°, PUSH IN, Spring connection, Clamping range, max. : 3.31 mm ² ,	UL: 300 V / 18.5 A / AWG 26 - AWG 12	
Qty.	36 pc(s).	Box		
Type	BLF 5.08HC/10/90 SN OR ...	Version	Product data	Packaging
Order No.	1001610000	PCB plug-in connector, female plug, 5.08 mm, Number of poles: 10,	IEC: 400 V / 24 A / 0.2 - 2.5 mm ²	Box
GTIN (EAN)	4032248693412	90°, PUSH IN, Spring connection, Clamping range, max. : 3.31 mm ² ,	UL: 300 V / 18.5 A / AWG 26 - AWG 12	
Qty.	36 pc(s).	Box		

**OMNIMATE Signal - series BL/SL 5.08
SLF 5.08/10/180B SN BK BX**

Weidmüller Interface GmbH & Co. KG
Klingenbergstraße 26
D-32758 Detmold
Germany
Fon: +49 5231 14-0
Fax: +49 5231 14-292083
www.weidmuller.com

Mating connector (fully pluggable)**BLDT 5.08**

Female plugs with two clamping-yoke screw connections per pole for wire connections with 90° and 270° outlet directions. The female plugs provide space for labelling and can be coded.

General ordering data

Type	BLDT 5.08/10/- SN BK BX	Version	Product data	Packaging
Order No.	1660790000	PCB plug-in connector, female plug, 5.08 mm, Number of poles: 10,	IEC: 400 V / 14 A / 0.2 - 2.5 mm ²	Box
GTIN (EAN)	4008190417246	180°, Clamping yoke connection, Clamping range, max. : 3.31 mm ² ,	UL: 300 V / 10 A / AWG 26 - AWG 12	
Qty.	50 pc(s).	Box		
Type	BLDT 5.08/10/- SN OR BX	Version	Product data	Packaging
Order No.	1644810000	PCB plug-in connector, female plug, 5.08 mm, Number of poles: 10,	IEC: 400 V / 14 A / 0.2 - 2.5 mm ²	Box
GTIN (EAN)	4008190284022	180°, Clamping yoke connection, Clamping range, max. : 3.31 mm ² ,	UL: 300 V / 10 A / AWG 26 - AWG 12	
Qty.	30 pc(s).	Box		

BLF 5.08HC/270 SN

Just as reliable as the millionfold proven original and featuring innovative details:

The BLF 5.08HC PUSH IN version of the BLZP 5.08HC female connector is not only different in terms of connection system; it also has a more compact design. Weidmüller's innovative PUSH IN spring connection system stands for the future of easy and tool-free wire connection. HC = High Current.

In terms of versatility, the BLF 5.08HC offers just as much as the version which served as a model:

- 3 tested-and-proven wire outlet directions provide the usual flexibility for application-specific design
- 4 flange variations and the patented release latch allow the locking concept to be based on the requirements of the user
- Use the BLF 5.08HC and SL 5.08HC plug combination to reach the max. rated specifications

General ordering data

Type	BLF 5.08HC/10/270 SN BK ...	Version	Product data	Packaging
Order No.	1982010000	PCB plug-in connector, female plug, 5.08 mm, Number of poles: 10,	IEC: 400 V / 24 A / 0.2 - 2.5 mm ²	Box
GTIN (EAN)	4032248684700	270°, PUSH IN, Spring connection, Clamping range, max. : 3.31 mm ² ,	UL: 300 V / 18.5 A / AWG 26 - AWG 12	
Qty.	36 pc(s).	Box		
Type	BLF 5.08HC/10/270 SN OR ...	Version	Product data	Packaging
Order No.	1982780000	PCB plug-in connector, female plug, 5.08 mm, Number of poles: 10,	IEC: 400 V / 24 A / 0.2 - 2.5 mm ²	Box
GTIN (EAN)	4032248686872	270°, PUSH IN, Spring connection, Clamping range, max. : 3.31 mm ² ,	UL: 300 V / 18.5 A / AWG 26 - AWG 12	
Qty.	36 pc(s).	Box		

**OMNIMATE Signal - series BL/SL 5.08
SLF 5.08/10/180B SN BK BX**

Weidmüller Interface GmbH & Co. KG
Klingenbergstraße 26
D-32758 Detmold
Germany
Fon: +49 5231 14-0
Fax: +49 5231 14-292083
www.weidmueller.com

Mating connector (fully pluggable)
BLZP 5.08HC/225B SN

Clamping-yoke connection with right-angled (90° or 270°) or angled (225°) outlet direction. The female connectors provide space for labelling and can be coded. Fastened by means of a flange or release latch. They also provide an integrated plus/minus screw, protection against faulty insertion of the wire, and they are delivered with open clamping yokes. HC = High Current.

General ordering data

Type	BLZP 5.08HC/10/225B SN ...	Version	Product data	Packaging
Order No.	1945830000	PCB plug-in connector, female plug, 5.08 mm, Number of poles: 10,	IEC: 400 V / 17.5 A / 0.2 - 4 mm ²	Box
GTIN (EAN)	4032248621309	225°, Clamping yoke connection, Clamping range, max. : 4 mm ² , Box	UL: 300 V / 15 A / AWG 26 - AWG 12	
Qty.	30 pc(s).			
Type	BLZP 5.08HC/10/225B SN ...	Version	Product data	Packaging
Order No.	1946060000	PCB plug-in connector, female plug, 5.08 mm, Number of poles: 10,	IEC: 400 V / 17.5 A / 0.2 - 4 mm ²	Box
GTIN (EAN)	4032248621590	225°, Clamping yoke connection, Clamping range, max. : 4 mm ² , Box	UL: 300 V / 15 A / AWG 26 - AWG 12	
Qty.	30 pc(s).			

BLL 5.08/180

Female header for PCB mounting. The solder pin length is optimised for wave flow soldering.

General ordering data

Type	BLL 5.08/10/180 3.2 SN ...	Version	Product data	Packaging
Order No.	1630790000	PCB plug-in connector, female header, closed side, THT solder	IEC: 400 V / 23 A	Box
GTIN (EAN)	4008190204228	connection, 5.08 mm, Number of poles: 10, 180°, Solder pin length	UL: 300 V / 15 A	
Qty.	36 pc(s).	(I): 3.2 mm, tinned, orange, Box		

**OMNIMATE Signal - series BL/SL 5.08
SLF 5.08/10/180B SN BK BX**

Weidmüller Interface GmbH & Co. KG
Klingenbergstraße 26
D-32758 Detmold
Germany
Fon: +49 5231 14-0
Fax: +49 5231 14-292083
www.weidmueller.com

Mating connector (fully pluggable)
BLL 5.08/90

Female header for PCB mounting. The solder pin length is optimised for wave flow soldering.

General ordering data

Type	BLL 5.08/10/90 3.2 SN O ...	Version	Product data	Packaging
Order No.	1623020000	PCB plug-in connector, female header, closed side, THT solder	IEC: 400 V / 23 A	Box
GTIN (EAN)	4008190194079	connection, 5.08 mm, Number of poles: 10, 90°, Solder pin length (l): 3.2 mm, tinned, orange, Box	UL: 300 V / 15 A	
Qty.	36 pc(s).			

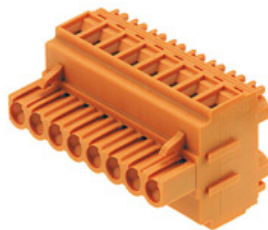
BLDT 5.08B

Female plugs with two clamping-yoke screw connections per pole for wire connections with 90° and 270° outlet directions. The female plugs provide space for labelling and can be coded.

General ordering data

Type	BLDT 5.08/10/-B SN OR BX	Version	Product data	Packaging
Order No.	1651820000	PCB plug-in connector, female plug, 5.08 mm, Number of poles: 10, 180°, Clamping yoke connection, Clamping range, max. : 3.31 mm², Box	IEC: 400 V / 14 A / 0.2 - 2.5 mm² UL: 300 V / 10 A / AWG 26 - AWG 12	Box
GTIN (EAN)	4008190400507			
Qty.	25 pc(s).			
Type	BLDT 5.08/10/-B SN BK BX	Version	Product data	Packaging
Order No.	1673860000	PCB plug-in connector, female plug, 5.08 mm, Number of poles: 10, 180°, Clamping yoke connection, Clamping range, max. : 3.31 mm², Box	IEC: 400 V / 14 A / 0.2 - 2.5 mm² UL: 300 V / 10 A / AWG 26 - AWG 12	Box
GTIN (EAN)	4008190435592			
Qty.	50 pc(s).			

**OMNIMATE Signal - series BL/SL 5.08
SLF 5.08/10/180B SN BK BX**

Weidmüller Interface GmbH & Co. KG
Klingenbergstraße 26
D-32758 Detmold
Germany
Fon: +49 5231 14-0
Fax: +49 5231 14-292083
www.weidmueller.com

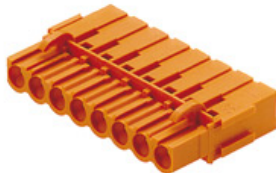
Mating connector (fully pluggable)
BLC 5.08BR

Female plugs with crimp wire connection system. The female plugs provide space for labelling and can be coded.

General ordering data

Type	BLC 5.08/10/180BR OR BX	Version	Product data	Packaging
Order No.	1649450000	PCB plug-in connector, female plug, 5.08 mm, Number of poles: 10,	IEC: 400 V / 21 A	Box
GTIN (EAN)	4008190294564	180°, Crimp connection, Clamping range, max. : 2.5 mm ² , Box	UL: 300 V / 10 A / AWG 26 - AWG 14	
Qty.	50 pc(s).			
Type	BLC 5.08/10/180BR BK BX	Version	Product data	Packaging
Order No.	1712190000	PCB plug-in connector, female plug, 5.08 mm, Number of poles: 10,	IEC: 400 V / 21 A	Box
GTIN (EAN)	4008190935207	180°, Crimp connection, Clamping range, max. : 2.5 mm ² , Box	UL: 300 V / 10 A / AWG 26 - AWG 14	
Qty.	50 pc(s).			

BLL 5.08/180B



Female header for PCB mounting. The solder pin length is optimised for wave flow soldering.

General ordering data

Type	BLL 5.08/10/180B 3.2SN ...	Version	Product data	Packaging
Order No.	1682810000	PCB plug-in connector, female header, Dovetails for fixing blocks, THT	IEC: 400 V / 23 A	Box
GTIN (EAN)	4008190474577	solder connection, 5.08 mm, Number of poles: 10, 180°, Solder pin	UL: 300 V / 15 A	
Qty.	30 pc(s).	length (l): 3.2 mm, tinned, orange, Box		

**OMNIMATE Signal - series BL/SL 5.08
SLF 5.08/10/180B SN BK BX**

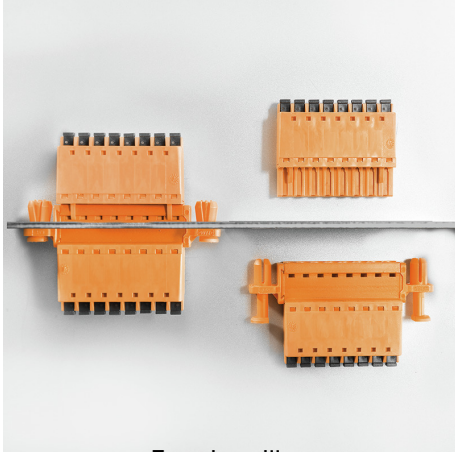
Weidmüller Interface GmbH & Co. KG
Klingenbergstraße 26
D-32758 Detmold
Germany
Fon: +49 5231 14-0
Fax: +49 5231 14-292083
www.weidmueller.com

Product benefits

Easy handling
No implementation framework necessary