

OMNIMATE Signal - series B2C/S2C 3.50 - 2-row B2CF 3.50/36/180LR SN OR BX

Weidmüller Interface GmbH & Co. KG
Klingenbergstraße 26
D-32758 Detmold
Germany
Fon: +49 5231 14-0
Fax: +49 5231 14-292083
www.weidmueller.com

Product image

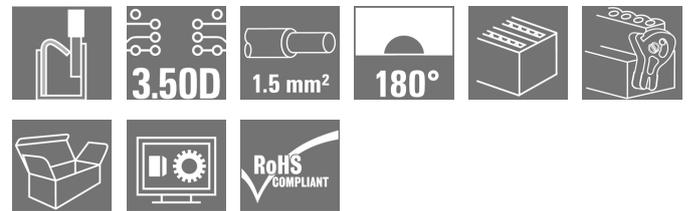

Similar to illustration

Two-row female plug with PUSH IN spring connection

- Simply insert the prepared wire - and you're done
- Intuitive to use because
- the wire-entry area and handling area are clearly separated
- Integrated push-buttons for opening the terminal point
- High component density because of low heights
- Optional: locking and releasing require no tools when using Weidmüller's release latch (LR) or release lever (LH)

General ordering data

Type	B2CF 3.50/36/180LR SN OR BX
Order No.	1278210000
Version	PCB plug-in connector, female plug, 3.50 mm, Number of poles: 36, 180°, PUSH IN, Spring connection, Clamping range, max. : 1.5 mm², Box
GTIN (EAN)	4050118069204
Qty.	24 pc(s).
Product data	IEC: 320 V / 13.4 A / 0.14 - 1.5 mm² UL: 300 V / 9.5 A / AWG 26 - AWG 16
Packaging	Box

Creation date May 2, 2020 10:02:29 PM CEST

**OMNIMATE Signal - series B2C/S2C 3.50 - 2-row
B2CF 3.50/36/180LR SN OR BX**

Weidmüller Interface GmbH & Co. KG
Klingenbergstraße 26
D-32758 Detmold
Germany
Fon: +49 5231 14-0
Fax: +49 5231 14-292083
www.weidmueller.com

Technical data
Dimensions and weights

Width	69.9 mm	Width (inches)	2.752 inch
Height	17.25 mm	Height (inches)	0.679 inch
Depth	29.9 mm	Depth (inches)	1.177 inch
Net weight	24.424 g		

System Parameters

Product family	OMNIMATE Signal - series B2C/S2C 3.50 - 2-row	Type of connection	Field connection
Wire connection method	PUSH IN, Spring connection	Pitch in mm (P)	3.5 mm
Pitch in inches (P)	0.138 inch	Conductor outlet direction	180°
Number of poles	36	L1 in mm	59.5 mm
L1 in inches	2.343 inch	Number of rows	1
Pin series quantity	2	Rated cross-section	1.5 mm ²
Touch-safe protection acc. to DIN VDE 57 106	Safe from finger touch	Touch-safe protection acc. to DIN VDE 0470	IP 20
Can be coded	Yes	Stripping length	10 mm
Actuating force actuating element, max.	40 N	Screwdriver blade	0.4 x 2.5
Screwdriver blade standard	DIN 5264	Plugging cycles	25
Plugging force/pole, max.	5 N	Pulling force/pole, max.	5 N

Material data

Insulating material	PA 66 GF 30	Colour	orange
Colour of operational elements	black	Material of operational elements	PA 66/6
Colour chart (similar)	RAL 2000	Insulating material group	II
Comparative Tracking Index (CTI)	≥ 600	Insulation strength	≥ 10 ⁸ Ω
UL 94 flammability rating	V-0	GWFI	960 °C
Contact material	Copper alloy	Contact surface	tinned
Layer structure of plug contact	2-5 µm Au	Storage temperature, min.	-25 °C
Storage temperature, max.	50 °C	Max. relative humidity during storage	70 %
Operating temperature, min.	-50 °C	Operating temperature, max.	120 °C
Temperature range, installation, min.	-40 °C	Temperature range, installation, max.	120 °C

Conductors suitable for connection

Clamping range, min.	0.14 mm ²
Clamping range, max.	1.5 mm ²
Solid, min. H05(07) V-U	0.14 mm ²
Solid, max. H05(07) V-U	1.5 mm ²
Flexible, min. H05(07) V-K	0.14 mm ²
Flexible, max. H05(07) V-K	1.5 mm ²
w. plastic collar ferrule, DIN 46228 pt 4, 0.14 mm ² min.	
w. plastic collar ferrule, DIN 46228 pt 4, 1 mm ² max.	
w. wire end ferrule, DIN 46228 pt 1, 0.14 mm ² min.	
w. wire end ferrule, DIN 46228 pt 1, 1.5 mm ² max.	

**OMNIMATE Signal - series B2C/S2C 3.50 - 2-row
B2CF 3.50/36/180LR SN OR BX**

Weidmüller Interface GmbH & Co. KG
Klingenbergstraße 26
D-32758 Detmold
Germany
Fon: +49 5231 14-0
Fax: +49 5231 14-292083
www.weidmueller.com

Technical data

Clampable conductor	Cross-section for conductor connection	Type	fine-wired	
		nominal	0.5 mm ²	
	wire end ferrule	Stripping length	nominal	12 mm
		Recommended wire-end ferrule	H0.5/16 OR	
		Stripping length	nominal	10 mm
		Recommended wire-end ferrule	H0.5/10	
	Cross-section for conductor connection	Type	fine-wired	
		nominal	0.75 mm ²	
	wire end ferrule	Stripping length	nominal	14 mm
		Recommended wire-end ferrule	H0.75/18 W	
		Stripping length	nominal	10 mm
		Recommended wire-end ferrule	H0.75/10	
	Cross-section for conductor connection	Type	fine-wired	
		nominal	1 mm ²	
	wire end ferrule	Stripping length	nominal	15 mm
		Recommended wire-end ferrule	H1.0/18D R	
Stripping length		nominal	10 mm	
Recommended wire-end ferrule		H1.0/10		
Cross-section for conductor connection	Type	fine-wired		
	nominal	1.5 mm ²		
wire end ferrule	Stripping length	nominal	10 mm	
	Recommended wire-end ferrule	H1.5/10		
Reference text	The outside diameter of the plastic collar should not be larger than the pitch (P), Length of ferrules is to be chosen depending on the product and the rated voltage.			
Max. clamping range	1.5 mm ²			

Rated data acc. to IEC

tested acc. to standard	IEC 60664-1, IEC 61984	
Rated current, max. number of poles (Tu=20°C)	10 A	Rated current, min. number of poles (Tu=20°C) 13.4 A
Rated current, max. number of poles (Tu=40°C)	9 A	Rated current, min. number of poles (Tu=40°C) 12 A
Rated voltage for surge voltage class / pollution degree III/2	160 V	Rated voltage for surge voltage class / pollution degree II/2 320 V
Rated impulse voltage for surge voltage class/ pollution degree II/2	2.5 kV	Rated voltage for surge voltage class / pollution degree III/3 160 V
Rated impulse voltage for surge voltage class/ contamination degree III/3	2.5 kV	Rated impulse voltage for surge voltage class/ pollution degree III/2 2.5 kV
		Short-time withstand current resistance 3 x 1s with 80 A

OMNIMATE Signal - series B2C/S2C 3.50 - 2-row B2CF 3.50/36/180LR SN OR BX

Weidmüller Interface GmbH & Co. KG
 Klingenbergstraße 26
 D-32758 Detmold
 Germany
 Fon: +49 5231 14-0
 Fax: +49 5231 14-292083
 www.weidmueller.com

Technical data

Rated data acc. to CSA

Institute (CSA)				Certificate No. (CSA)	
				200039-1121690	
Rated voltage (Use group B / CSA)	300 V	Rated voltage (Use group C / CSA)	50 V		
Rated voltage (Use group D / CSA)	300 V	Rated current (Use group B / CSA)	9.5 A		
Rated current (Use group C / CSA)	9.5 A	Rated current (Use group D / CSA)	9.5 A		
Wire cross-section, AWG, min.	AWG 26	Wire cross-section, AWG, max.	AWG 16		
Reference to approval values	Specifications are maximum values, details - see approval certificate.				

Rated data acc. to UL 1059

Institute (cURus)				Certificate No. (cURus)	
				E60693	
Rated voltage (Use group B / UL 1059)	300 V	Rated voltage (Use group C / UL 1059)	50 V		
Rated voltage (Use group D / UL 1059)	300 V	Rated current (Use group B / UL 1059)	9.5 A		
Rated current (Use group C / UL 1059)	9.5 A	Rated current (Use group D / UL 1059)	9.5 A		
Wire cross-section, AWG, min.	AWG 26	Wire cross-section, AWG, max.	AWG 16		
Reference to approval values	Specifications are maximum values, details - see approval certificate.				

Packing

Packaging	Box	VPE length	35 mm
VPE width	135 mm	VPE height	350 mm

Type tests

Test: Durability of markings	Standard	IEC 61984 section 6.2 and 7.3.2 / 10.11 taking pattern from IEC 60068-2-70 / 12.95
	Test	mark of origin, type identification, pitch, type of material, date clock, approval marking UL, approval marking cULus
	Evaluation	available
	Test	durability
	Evaluation	passed
Test: Misengagement (Non-interchangeability)	Standard	IEC 61984 section 6.3 and 6.9.1 / 10.11, IEC 60512-13-5 / 02.06
	Test	180° turned without coding elements
	Evaluation	passed
	Test	180° turned with coding elements
	Evaluation	passed
	Test	visual examination
	Evaluation	passed

**OMNIMATE Signal - series B2C/S2C 3.50 - 2-row
B2CF 3.50/36/180LR SN OR BX**

Weidmüller Interface GmbH & Co. KG
Klingenbergstraße 26
D-32758 Detmold
Germany
Fon: +49 5231 14-0
Fax: +49 5231 14-292083
www.weidmueller.com

Technical data

Test: Clampable cross section	Standard	IEC 60999-1 section 7 and 9.1 / 11.99, IEC 60947-1 section 8.2.4.5.1 / 03.11	
	Conductor type	Type of conductor and conductor cross-section	solid 0.14 mm ²
		Type of conductor and conductor cross-section	stranded 0.14 mm ²
		Type of conductor and conductor cross-section	solid 1.5 mm ²
		Type of conductor and conductor cross-section	stranded 1.5 mm ²
		Type of conductor and conductor cross-section	AWG 26/1
		Type of conductor and conductor cross-section	AWG 26/19
		Type of conductor and conductor cross-section	AWG 16/1
		Type of conductor and conductor cross-section	AWG 16/19
Evaluation	passed		
Test for damage to and accidental loosening of conductors	Standard	IEC 60999-1 section 9.4 / 11.99	
	Requirement	0.2 kg	
	Conductor type	Type of conductor and conductor cross-section	AWG 26/1
		Type of conductor and conductor cross-section	AWG 26/19
	Evaluation	passed	
	Requirement	0.3 kg	
	Conductor type	Type of conductor and conductor cross-section	H05V-U0.75
		Type of conductor and conductor cross-section	H05V-K0.75
	Evaluation	passed	
	Requirement	0.4 kg	
	Conductor type	Type of conductor and conductor cross-section	H07V-U1.5
		Type of conductor and conductor cross-section	H07V-K1.5
		Type of conductor and conductor cross-section	AWG 16/1
Type of conductor and conductor cross-section		AWG 16/19	
Evaluation	passed		

**OMNIMATE Signal - series B2C/S2C 3.50 - 2-row
B2CF 3.50/36/180LR SN OR BX**

Weidmüller Interface GmbH & Co. KG
 Klingenbergstraße 26
 D-32758 Detmold
 Germany
 Fon: +49 5231 14-0
 Fax: +49 5231 14-292083
 www.weidmueller.com

Technical data

Pull-out test	Standard	IEC 60999-1 section 9.5 / 11.99		
	Requirement	≥10 N		
	Conductor type	Type of conductor and conductor cross-section	AWG 26/1	
		Type of conductor and conductor cross-section	AWG 26/19	
	Evaluation	passed		
	Requirement	≥20 N		
	Conductor type	Type of conductor and conductor cross-section	H05V-U0.75	
		Type of conductor and conductor cross-section	H05V-K0.75	
	Evaluation	passed		
	Requirement	≥40 N		
	Conductor type	Type of conductor and conductor cross-section	H07V-U1.5	
		Type of conductor and conductor cross-section	H07V-K1.5	
		Type of conductor and conductor cross-section	AWG 16/1	
		Type of conductor and conductor cross-section	AWG 16/19	
	Evaluation	passed		

Classifications

ETIM 6.0	EC002638	ETIM 7.0	EC002638
eClass 9.0	27-44-03-09	eClass 9.1	27-44-03-09
eClass 10.0	27-44-03-09		

**OMNIMATE Signal - series B2C/S2C 3.50 - 2-row
B2CF 3.50/36/180LR SN OR BX**

Weidmüller Interface GmbH & Co. KG
Klingenbergstraße 26
D-32758 Detmold
Germany
Fon: +49 5231 14-0
Fax: +49 5231 14-292083
www.weidmueller.com

Technical data

Notes

Notes

- Additional colours on request
- Gold-plated contact surfaces on request
- Rated current related to rated cross-section & min. No. of poles.
- Crimp shape A for wire-end ferrules with crimping tools PZ 1,5 (order no. 9005990000) or PZ 6/5 (order no. 9011460000) for larger wire cross-sections recommended.
- P on drawing = pitch
- Rated data refer only to the component itself. Clearance and creepage distances to other components are to be designed in accordance with the relevant application standards.
- Max. outer diameter of the conductor 2.6 mm

Wire-end ferrule w/plastic collar DIN 46228/4 or Weidmüller colour code

- 1.00mm² [H1.0/18D] mtl. ferrule leng. 12mm, stripping leng. 15mm
- 0.75mm² [H0.75/18D] mtl. ferrule leng. 12mm, stripping leng. 14mm
- 0.50mm² [H0.5/16D] mtl. ferrule leng. 10mm, stripping leng. 12mm
- 0.34mm² [H0.34/12] mtl. ferrule leng. 8mm, stripping leng. 10mm
- 0.25mm² [H0.25/12] mtl. ferrule leng. 8mm, stripping leng. 10mm
- 0.14mm² [H0.14/12] mtl. ferrule leng. 8mm, stripping leng. 10mm

Wire-end ferrule w/o plastic collar acc. to DIN 46228/1

- 1.50mm² [H1.5/10] mtl. ferrule leng. 10mm, stripping leng. 10mm

Wire-end ferrule w/plastic collar DIN 46228/4 and 2 connec. cables

- 2 x 0.20mm² [H0.5/16] mtl. ferrule leng. 10mm, stripping leng. 12mm
- 2 x 0.34mm² [H1.0/18] mtl. ferrule leng. 12mm, stripping leng. 15mm

IPC conformity

Conformity: The products are developed, manufactured and delivered according international recognized standards and norms and comply with the assured properties in the data sheet resp. fulfill decorative properties in accordance with IPC-A-610 "Class 2". Further claims on the products can be evaluated on request.

Approvals

Approvals



ROHS

Conform

Data sheet

OMNIMATE Signal - series B2C/S2C 3.50 - 2-row B2CF 3.50/36/180LR SN OR BX

Weidmüller Interface GmbH & Co. KG
 Klingenbergstraße 26
 D-32758 Detmold
 Germany
 Fon: +49 5231 14-0
 Fax: +49 5231 14-292083
 www.weidmueller.com

Technical data

Downloads

Approval/Certificate/Document of Conformity	Declaration of the Manufacturer
Brochure/Catalogue	FL DRIVES EN MB DEVICE MANUF. EN FL DRIVES DE CAT 2 PORTFOLIOGUIDE EN FL BUILDING SAFETY EN FL APPL LED LIGHTING EN FL INDUSTR.CONTROLS EN FL MACHINE SAFETY EN FL HEATING ELECTR EN FL APPL INVERTER EN FL BASE STATION EN FL ELEVATOR EN FL POWER SUPPLY EN FL 72H SAMPLE SER EN PO OMNIMATE EN
Engineering Data	EPLAN, WSCAD
Engineering Data	STEP
Product Change Notification	Change of Material LR 3.50 - DE Change of Material LR 3.50 - EN
User Documentation	Operating instruction
White paper PUSH IN wire connection	Download Whitepaper

**OMNIMATE Signal - series B2C/S2C 3.50 - 2-row
B2CF 3.50/36/180LR SN OR BX**

Weidmüller Interface GmbH & Co. KG
Klingenbergstraße 26
D-32758 Detmold
Germany
Fon: +49 5231 14-0
Fax: +49 5231 14-292083
www.weidmueller.com

Drawings

Dimensional drawing

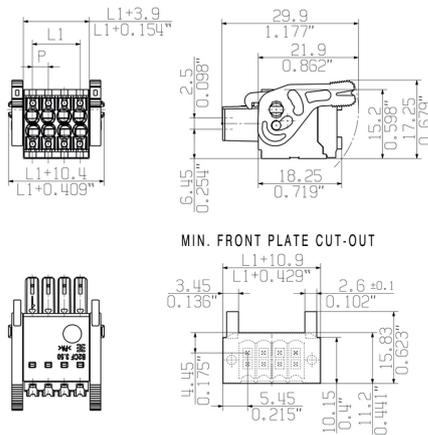

Graph

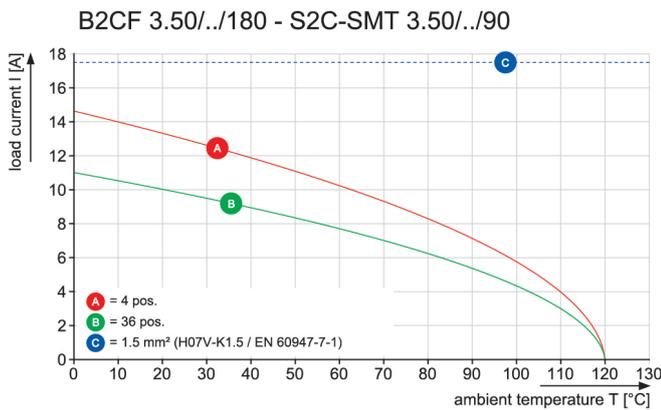

Product benefits



Solid PUSH IN contact
Safe and durable

Product benefits

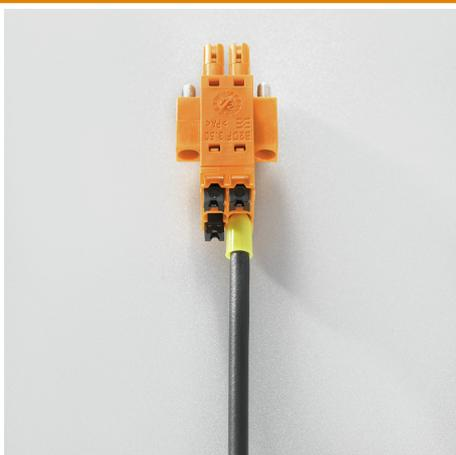

Large connection cross-section
Up to 1.5 mm possible with ease

Product benefits

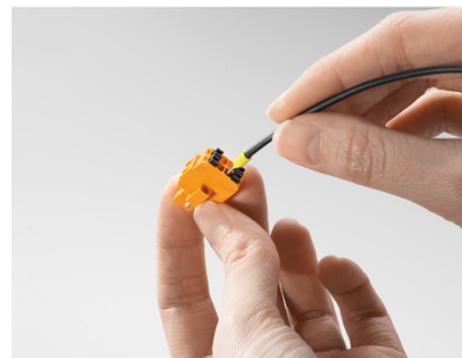

Fast PUSH IN connection
Tool-free and touch-safe

OMNIMATE Signal - series B2C/S2C 3.50 - 2-row B2CF 3.50/36/180LR SN OR BX

Weidmüller Interface GmbH & Co. KG
 Klingenbergstraße 26
 D-32758 Detmold
 Germany
 Fon: +49 5231 14-0
 Fax: +49 5231 14-292083
 www.weidmueller.com

Mating connector (fully pluggable)

S2C-SMT 3.50/90LF Box



High-temperature-resistant male header

- Finger-safe
- Can be plugged into female plug B2CF 3.50 PUSH IN
- **Plug-in direction is perpendicular or parallel to the circuit board (180° / 90°)**
- Housing variants: closed (G) and with solder flange (LF)
- **Packed either in a box (BX) or on anti-static tape-on-reel (RL)**
- Suitable for reflow and wave soldering applications
- Pin length of either 1.5 mm or 3.2 mm

General ordering data

Type	S2C-SMT 3.50/36/90LF 3. ...	Version	Product data	Packaging
Order No.	1289620000	PCB plug-in connector, male header, Solder flange, THT/THR solder connection, 3.50 mm, Number of poles: 36, 90°, Solder pin length (l): 3.2 mm, tinned, black, Box	IEC: 200 V / 13.4 A UL: 150 V / 10 A	Box
GTIN (EAN)	4050118082425			
Qty.	24 pc(s).			
Type	S2C-SMT 3.50/36/90LF 1. ...	Version	Product data	Packaging
Order No.	1290020000	PCB plug-in connector, male header, Solder flange, THT/THR solder connection, 3.50 mm, Number of poles: 36, 90°, Solder pin length (l): 1.5 mm, tinned, black, Box	IEC: 200 V / 13.4 A UL: 150 V / 10 A	Box
GTIN (EAN)	4050118082944			
Qty.	24 pc(s).			

S2C-SMT 3.50/180LF Box



High-temperature-resistant pin header.

- touch-safe
- can be plugged into B2CF 3.50 PUSH IN female plug
- Plug-in direction is perpendicular or parallel to the circuit board (180° / 90°)
- Housing variants: closed (G) and with solder flange (LF)
- Box packaging (BX) or, anti-static, tape-on-reel (RL)
- Suitable for reflow and wave soldering applications
- Pin length of either 1.5 mm or 3.5 mm

General ordering data

Type	S2C-SMT 3.50/36/180LF 3 ...	Version	Product data	Packaging
Order No.	1290390000	PCB plug-in connector, male header, Solder flange, THT/THR solder connection, 3.50 mm, Number of poles: 36, 180°, Solder pin length (l): 3.5 mm, tinned, black, Box	IEC: 200 V / 13.4 A UL: 150 V / 10 A	Box
GTIN (EAN)	4050118082869			
Qty.	24 pc(s).			

**OMNIMATE Signal - series B2C/S2C 3.50 - 2-row
B2CF 3.50/36/180LR SN OR BX**

Weidmüller Interface GmbH & Co. KG
Klingenbergstraße 26
D-32758 Detmold
Germany
Fon: +49 5231 14-0
Fax: +49 5231 14-292083
www.weidmueller.com

Accessories

Blank

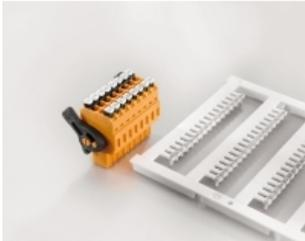

Weidmüller has established new market standards with its MultiCard product line. This system is being continually extended with over 200 variants and by consistently extending the portfolio.

For custom printing: Please send us a file of our labeling software M-Print PRO or M-Print PRO Online (without installation) for your labeling specifications.

General ordering data

Type	PM 2.7/2.6 MC NE GE	Version
Order No.	1435010000	OMNIMATE Signal - series PM, Pusher markers, 2.7 x 2.6 mm, Pitch in
GTIN (EAN)	4050118239768	mm (P): 3.50 Weidmueller, yellow
Qty.	960 pc(s).	
Type	PM 2.7/2.6 MC NE WS	Version
Order No.	1323710000	OMNIMATE Signal - series PM, Pusher markers, 2.7 x 2.6 mm, Pitch in
GTIN (EAN)	4050118126778	mm (P): 3.50 Weidmueller, white
Qty.	960 pc(s).	

Custom printing

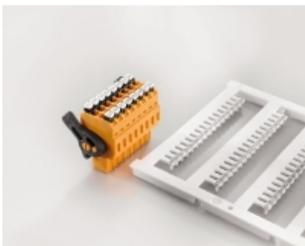

Weidmüller has established new market standards with its MultiCard product line. This system is being continually extended with over 200 variants and by consistently extending the portfolio.

For custom printing: Please send us a file of our labeling software M-Print PRO or M-Print PRO Online (without installation) for your labeling specifications.

General ordering data

Type	PM 2.7/2.6 MC SDR	Version
Order No.	1323700000	OMNIMATE Signal - series PM, Pusher markers, 2.7 x 2.6 mm, Pitch in
GTIN (EAN)	4050118126761	mm (P): 3.50 Weidmueller, To customer specification
Qty.	192 pc(s).	

OMNIMATE Signal - series B2C/S2C 3.50 - 2-row B2CF 3.50/36/180LR SN OR BX

Weidmüller Interface GmbH & Co. KG
 Klingenbergstraße 26
 D-32758 Detmold
 Germany
 Fon: +49 5231 14-0
 Fax: +49 5231 14-292083
 www.weidmueller.com

Accessories

Coding elements



**Only connects what is supposed to be connected:
the right connection at the right place.**

Coding elements and locking devices clearly assign connecting elements during the manufacturing process and operation

The coding elements and locking devices are inserted prior to assembly or during the cable assembly phase. The Weidmüller alternative: configure online using the variant configurator to precode prior to delivery.

Incorrect assembly on the circuit board and incorrect plugging of connecting elements is no longer possible. The advantage: no troubleshooting during manufacture and no operational errors by the user.

General ordering data

Type	B2L/S2L 3.50 KO BK BX	Version	Product data	Packaging
Order No.	1849740000	PCB plug-in connector, Accessories, Coding element, black, Number		Box
GTIN (EAN)	4032248378203	of poles: 1		
Qty.	100 pc(s).			
Type	B2L/S2L 3.50 KO OR BX	Version	Product data	Packaging
Order No.	1849730000	PCB plug-in connector, Accessories, Coding element, orange, Number		Box
GTIN (EAN)	4032248378197	of poles: 1		
Qty.	100 pc(s).			

Data sheet**OMNIMATE Signal - series B2C/S2C 3.50 - 2-row
B2CF 3.50/36/180LR SN OR BX**

Weidmüller Interface GmbH & Co. KG
Klingenbergstraße 26
D-32758 Detmold
Germany
Fon: +49 5231 14-0
Fax: +49 5231 14-292083
www.weidmueller.com

Drawings**Product benefits**

Clear marking
Unique designation

Example of use