

## Industrial Ethernet IE-C5DS4UG0070MBSMCS-E

**Weidmüller Interface GmbH & Co. KG**  
Klingenbergstraße 26  
D-32758 Detmold  
Germany  
Fon: +49 5231 14-0  
Fax: +49 5231 14-292083  
www.weidmueller.com



Assembled IE cables, PROFINET, Cat. 5, PUR, green

### General ordering data

Type	IE-C5DS4UG0070MBSMCS-E
Order No.	<a href="#">1244130070</a>
Version	System cable, M12 D-code – flange, M12 D-code – pin straight, 7 m
GTIN (EAN)	4050118624830
Qty.	1 pc(s).

Creation date May 2, 2020 5:32:48 PM CEST

Catalogue status 17.04.2020 / We reserve the right to make technical changes.

## Data sheet

### Industrial Ethernet IE-C5DS4UG0070MBSMCS-E

**Weidmüller Interface GmbH & Co. KG**  
 Klingenbergstraße 26  
 D-32758 Detmold  
 Germany  
 Fon: +49 5231 14-0  
 Fax: +49 5231 14-292083  
 www.weidmueller.com

## Technical data

### Dimensions and weights

Length	7 m	Length (inches)	0.276 inch
Net weight	486 g		

### Environmental Product Compliance

REACH SVHC	Lead 7439-92-1
------------	----------------

### plug

Connector left	M12 D-code – flange	Connector right	M12 D-code – pin straight
----------------	---------------------	-----------------	---------------------------

### Classifications

ETIM 6.0	EC002599	ETIM 7.0	EC002599
eClass 9.0	27-06-03-08	eClass 9.1	27-06-03-08
eClass 10.0	27-06-03-08		

### Approvals

ROHS	Conform
------	---------

**Data sheet**

**Industrial Ethernet  
IE-C5DS4UG0070MBSMCS-E**

**Weidmüller Interface GmbH & Co. KG**  
 Klingenbergstraße 26  
 D-32758 Detmold  
 Germany  
 Fon: +49 5231 14-0  
 Fax: +49 5231 14-292083  
 www.weidmueller.com

**Drawings**

**Wiring diagram**

M12		M12
1	yellow	1
2	white	2
3	orange	3
4	blue	4

**Dimensioned drawing**

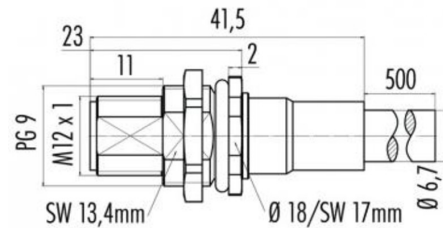

Hexagon nut enclosed loosely

**Dimensioned drawing**

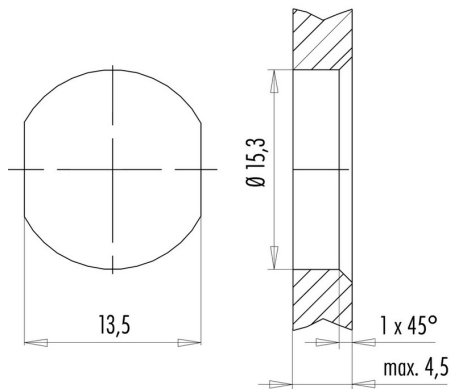

with through hole

**Industrial Ethernet  
IE-C5DS4UG0070MBSMCS-E**

**Weidmüller Interface GmbH & Co. KG**  
 Klingenbergstraße 26  
 D-32758 Detmold  
 Germany  
 Fon: +49 5231 14-0  
 Fax: +49 5231 14-292083  
 www.weidmueller.com

**Accessories**

**Blank**



TM-I is an acknowledged and accredited marker type for traffic engineering applications. There are five different tag lengths available for individual labelling with long character strings. Easy handling of separation and installation thanks to the project marker field. Pre-attachment of sleeves and retrofitting of tags offer excellent versatility

The special contour of TM-I allows easy assembly and secures firm positioning. They are compatible with a number of commercially available sleeves. Thanks to the MultiCard format, the tags can be printed quickly and conveniently with the SMark laser printer, PrintJet ADVANCED, plotter, MC-Mobilo or the STI pen.

- Easy handling of separation and installation thanks to the project marker field.
- Acknowledged and accredited marker for traffic engineering applications
- Pre-attachment of sleeves and retrofitting of tags offer excellent versatility
- Not suited for labelling with P-Ink or STI pen in connection with CLI T sleeves

**For custom printing:** Please send us a file of our labeling software M-Print PRO or M-Print PRO Online (without installation) for your labeling specifications.

**General ordering data**

Type	TM-I 12 MC NE WS	Version
Order No.	<a href="#">1718411044</a>	TM-I, Insert markers, 12 x 4 mm, white
GTIN (EAN)	4008190348977	
Qty.	320 pc(s).	

**Tool**



Tools for stripping the sheathing from uncut power lines and outlet lines, plus screwdrivers for installing Pick-to-Light components.

**General ordering data**

Type	SCREWTY SET -DM	Version
Order No.	<a href="#">1920000000</a>	Tools, Bolting tool
GTIN (EAN)	4032248436859	
Qty.	1 pc(s).	

**Industrial Ethernet  
IE-C5DS4UG0070MBSMCS-E**

**Weidmüller Interface GmbH & Co. KG**  
Klingenbergstraße 26  
D-32758 Detmold  
Germany  
Fon: +49 5231 14-0  
Fax: +49 5231 14-292083  
www.weidmueller.com

**Accessories**

Type	SCREWTY-M12-DM	Version
Order No.	<a href="#">1900001000</a>	Tools, Cable gland tool for moulded M12 lines
GTIN (EAN)	4032248436408	
Qty.	1 pc(s).	

**Blank**



TM-I is an acknowledged and accredited marker type for traffic engineering applications. There are five different tag lengths available for individual labelling with long character strings. Easy handling of separation and installation thanks to the project marker field. Pre-attachment of sleeves and retrofitting of tags offer excellent versatility

The special contour of TM-I allows easy assembly and secures firm positioning. They are compatible with a number of commercially available sleeves. Thanks to the MultiCard format, the tags can be printed quickly and conveniently with the SMark laser printer, PrintJet ADVANCED, plotter, MC-Mobilo or the STI pen.

- Easy handling of separation and installation thanks to the project marker field.
- Acknowledged and accredited marker for traffic engineering applications
- Pre-attachment of sleeves and retrofitting of tags offer excellent versatility
- Not suited for labelling with P-Ink or STI pen in connection with CLI T sleeves

**For custom printing:** Please send us a file of our labeling software M-Print PRO or M-Print PRO Online (without installation) for your labeling specifications.

**General ordering data**

Type	TM-I 18 MC NE WS	Version
Order No.	<a href="#">1718431044</a>	TM-I, Insert markers, 18 x 4 mm, white
GTIN (EAN)	4008190349011	
Qty.	320 pc(s).	

**Industrial Ethernet  
IE-C5DS4UG0070MBSMCS-E**

**Weidmüller Interface GmbH & Co. KG**  
Klingenbergstraße 26  
D-32758 Detmold  
Germany  
Fon: +49 5231 14-0  
Fax: +49 5231 14-292083  
www.weidmueller.com

**Accessories**

**Screwty® cable gland tool**



**The ideal tool for any application**

Screwty® is the ideal, all-purpose tool for tightening all common sensor and actuator cables. Even difficult-to-reach round plugs are accessible using the Screwty®. A simple turning movement tightens and loosens the connectors without the need for excessive force. The Screwty® is a unique and global solution since it fits with most cables and plugs from other vendors (over 90 %). The Screwty® consists of a handle with a conventional 1/4" adapter. Thus it can be used for all sizes: for M12 and M8 round plug-in connectors, and for M12F and M8F customisable plugs and sockets, as well as for all M23 plugs and sockets.

**General ordering data**

Type	SCREWTY- M12	Version
Order No.	<a href="#">1900000000</a>	Tools, Cable gland tool for moulded M12 lines
GTIN (EAN)	4032248375868	
Qty.	1 pc(s).	
Type	SCREWTY SET	Version
Order No.	<a href="#">1910000000</a>	Tools, Bolting tool
GTIN (EAN)	4032248436842	
Qty.	1 pc(s).	