

**OMNIMATE Signal - series BL/SL 5.08
SL 5.08HC/18/90LF 3.2SN BK BX**

Weidmüller Interface GmbH & Co. KG
Klingenbergstraße 26
D-32758 Detmold
Germany
Fon: +49 5231 14-0
Fax: +49 5231 14-292083
www.weidmueller.com

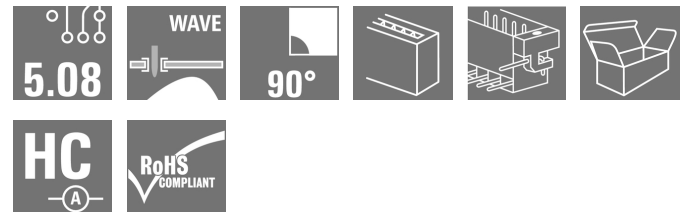

Similar to illustration

Pin headers made from glass-fibre-reinforced plastic with 90° wire outlet; optimised for wave soldering. The flange variant (F) can be screwed onto the respective counter piece or the circuit board. There is no need for an extra screw to connect the circuit board when the solder flange (LF) version is used. This also protects the solder points from mechanical strain. All pin headers can be manually coded or ordered pre-coded. HC = High Current.

General ordering data

Type	SL 5.08HC/18/90LF 3.2SN BK BX
Order No.	1150520000
Version	PCB plug-in connector, male header, Solder flange, THT solder connection, 5.08 mm, Number of poles: 18, 90°, Solder pin length (l): 3.2 mm, tinned, black, Box
GTIN (EAN)	4032248937462
Qty.	18 pc(s).
Product data	IEC: 400 V / 24 A UL: 300 V / 18.5 A
Packaging	Box

Creation date May 2, 2020 7:39:19 AM CEST

**OMNIMATE Signal - series BL/SL 5.08
SL 5.08HC/18/90LF 3.2SN BK BX**

Weidmüller Interface GmbH & Co. KG
 Klingenbergstraße 26
 D-32758 Detmold
 Germany
 Fon: +49 5231 14-0
 Fax: +49 5231 14-292083
 www.weidmueller.com

Technical data**Dimensions and weights**

Width	101.24 mm	Width (inches)	3.986 inch
Height	11.7 mm	Height (inches)	0.461 inch
Height of lowest version	8.5 mm	Depth	12 mm
Depth (inches)	0.472 inch	Net weight	7.59 g

System specifications

Product family	OMNIMATE Signal - series BL/SL 5.08	Type of connection	Board connection
Mounting onto the PCB	THT solder connection	Pitch in mm (P)	5.08 mm
Pitch in inches (P)	0.2 inch	Outgoing elbow	90°
Number of poles	18	Number of solder pins per pole	1
Solder pin length (l)	3.2 mm	Solder pin length tolerance	+0.1 / -0.3 mm
Tolerance of solder pin position	± 0.20 mm	Solder pin dimensions	d = 1.2 mm, Octagonal
Solder pin dimensions = d tolerance	0 / -0,03 mm	Solder eyelet hole diameter (D)	1.3 mm
Solder eyelet hole diameter tolerance (D)+	0,1 mm	L1 in mm	86.36 mm
L1 in inches	3.4 inch	Number of rows	1
Pin series quantity	1	Volume resistance	≤ 5mΩ
Can be coded	Yes	Plugging cycles	25
Plugging force/pole, max.	10 N	Pulling force/pole, max.	7.5 N

Material data

Insulating material	PA GF	Colour	black
Colour chart (similar)	RAL 9011	Insulating material group	II
Comparative Tracking Index (CTI)	≥ 550	Insulation strength	≥ 10 ⁸ Ω
UL 94 flammability rating	V-0	GWFI	960 °C
Contact material	CuMg	Contact surface	tinned
Layer structure of solder connection	1-3 μm Ni / 2-4 μm Sn matt	Layer structure of plug contact	1-3 μm Ni / 2-4 μm Sn matt
Storage temperature, min.	-25 °C	Storage temperature, max.	50 °C
Max. relative humidity during storage	70 %	Operating temperature, min.	-50 °C
Operating temperature, max.	100 °C	Temperature range, installation, min.	-25 °C
Temperature range, installation, max.	100 °C		

Rated data acc. to IEC

tested acc. to standard	IEC 60664-1, IEC 61984	Rated current, min. number of poles (Tu=20°C)	24 A
Rated current, max. number of poles (Tu=20°C)	19 A	Rated current, min. number of poles (Tu=40°C)	21 A
Rated current, max. number of poles (Tu=40°C)	16.5 A	Rated voltage for surge voltage class / pollution degree II/2	400 V
Rated voltage for surge voltage class / pollution degree III/2	320 V	Rated voltage for surge voltage class / pollution degree III/3	250 V
Rated impulse voltage for surge voltage class/ pollution degree II/2	4 kV	Rated impulse voltage for surge voltage class/ pollution degree III/2	4 kV
Rated impulse voltage for surge voltage class/ contamination degree III/3	4 kV		

Rated data acc. to CSA

Rated voltage (Use group B / CSA)	300 V	Rated voltage (Use group D / CSA)	300 V
Rated current (Use group B / CSA)	18.5 A	Rated current (Use group D / CSA)	10 A

Data sheet

**OMNIMATE Signal - series BL/SL 5.08
SL 5.08HC/18/90LF 3.2SN BK BX**

Weidmüller Interface GmbH & Co. KG
Klingenbergstraße 26
D-32758 Detmold
Germany
Fon: +49 5231 14-0
Fax: +49 5231 14-292083
www.weidmueller.com

Technical data

Rated data acc. to UL 1059

Institute (cURus)



Certificate No. (cURus)

E60693

Rated voltage (Use group B / UL 1059) 300 V

Rated voltage (Use group D / UL 1059) 300 V

Rated current (Use group B / UL 1059) 18.5 A

Rated current (Use group D / UL 1059) 10 A

Reference to approval values Specifications are maximum values, details - see approval certificate.

Packing

Packaging	Box	VPE length	0
VPE width	0	VPE height	0

Classifications

ETIM 6.0	EC002637	ETIM 7.0	EC002637
eClass 9.0	27-44-04-02	eClass 9.1	27-44-04-02
eClass 10.0	27-44-04-02		

Notes

- Notes
- Additional colours on request
 - Gold-plated contact surfaces on request
 - Rated current related to rated cross-section & min. No. of poles.
 - P on drawing = pitch
 - Rated data refer only to the component itself. Clearance and creepage distances to other components are to be designed in accordance with the relevant application standards.

IPC conformity Conformity: The products are developed, manufactured and delivered according international recognized standards and norms and comply with the assured properties in the data sheet resp. fulfill decorative properties in accordance with IPC-A-610 "Class 2". Further claims on the products can be evaluated on request.

Approvals

Approvals



ROHS Conform

Data sheet**OMNIMATE Signal - series BL/SL 5.08
SL 5.08HC/18/90LF 3.2SN BK BX**

Weidmüller Interface GmbH & Co. KG
Klingenbergstraße 26
D-32758 Detmold
Germany
Fon: +49 5231 14-0
Fax: +49 5231 14-292083
www.weidmueller.com

Technical data**Downloads**

Approval/Certificate/Document of Conformity	Declaration of the Manufacturer
Brochure/Catalogue	FL DRIVES EN MB DEVICE MANUF. EN FL DRIVES DE CAT 2 PORTFOLIOGUIDE EN FL BUILDING SAFETY EN FL APPL LED LIGHTING EN FL INDUSTR.CONTROLS EN FL MACHINE SAFETY EN FL HEATING ELECTR EN FL APPL INVERTER EN FL BASE STATION EN FL ELEVATOR EN FL POWER SUPPLY EN FL 72H SAMPLE SER EN PO OMNIMATE EN
Engineering Data	STEP

**OMNIMATE Signal - series BL/SL 5.08
SL 5.08HC/18/90LF 3.2SN BK BX**

Weidmüller Interface GmbH & Co. KG
Klingenbergstraße 26
D-32758 Detmold
Germany
Fon: +49 5231 14-0
Fax: +49 5231 14-292083
www.weidmueller.com

Drawings

Dimensional drawing

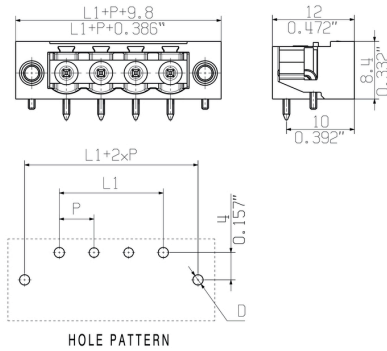

Graph

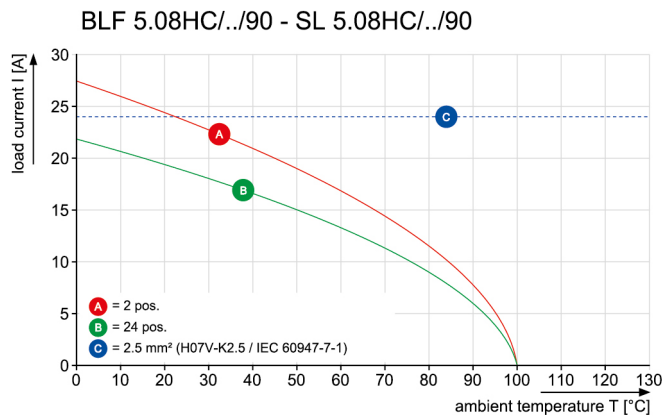

Graph

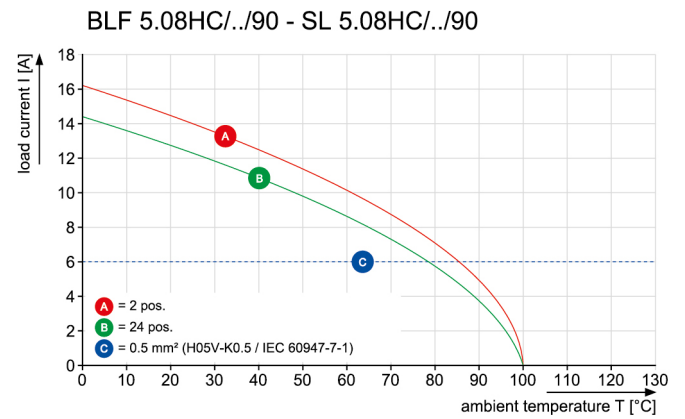

Graph

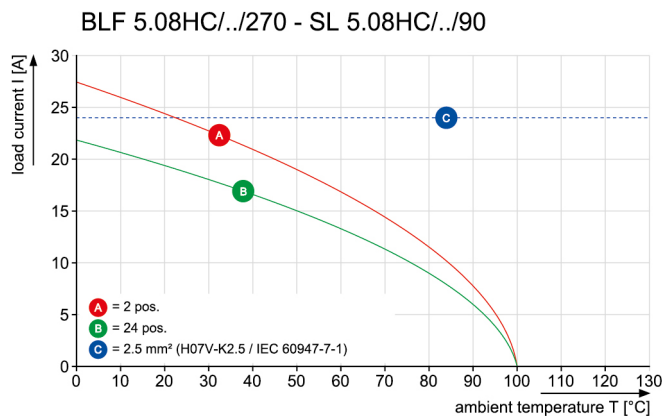

Graph

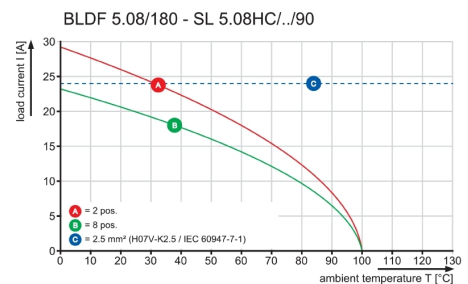

**OMNIMATE Signal - series BL/SL 5.08
SL 5.08HC/18/90LF 3.2SN BK BX**

Weidmüller Interface GmbH & Co. KG
Klingenbergstraße 26
D-32758 Detmold
Germany
Fon: +49 5231 14-0
Fax: +49 5231 14-292083
www.weidmueller.com

Mating connector (fully pluggable)
BLZP 5.08HC/180F SN

Female plug with clamping-yoke screw system for connecting wires with straight (180°) outlet direction. The female connectors provide space for labelling and can be coded. Fastened by means of a flange or release latch. They also provide an integrated plus/minus screw, protection against faulty insertion of the wire, and they are delivered with open clamping yokes. HC = High Current.

General ordering data

Type	BLZP 5.08HC/18/180F SN ...	Version	Product data	Packaging
Order No.	1944490000	PCB plug-in connector, female plug, 5.08 mm, Number of poles: 18,	IEC: 400 V / 23 A / 0.2 - 4 mm ²	Box
GTIN (EAN)	4032248619061	180°, Clamping yoke connection, Clamping range, max. : 4 mm ² , Box	UL: 300 V / 20 A / AWG 26 - AWG 12	
Qty.	18 pc(s).			
Type	BLZP 5.08HC/18/180F SN ...	Version	Product data	Packaging
Order No.	1944250000	PCB plug-in connector, female plug, 5.08 mm, Number of poles: 18,	IEC: 400 V / 23 A / 0.2 - 4 mm ²	Box
GTIN (EAN)	4032248618835	180°, Clamping yoke connection, Clamping range, max. : 4 mm ² , Box	UL: 300 V / 20 A / AWG 26 - AWG 12	
Qty.	18 pc(s).			

BLF 5.08HC/180LR SN

Just as reliable as the millionfold proven original and featuring innovative details:
The BLF 5.08HC PUSH IN version of the BLZP 5.08HC female connector is not only different in terms of connection system; it also has a more compact design. Weidmüller's innovative PUSH IN spring connection system stands for the future of easy and tool-free wire connection. HC = High Current.
In terms of versatility, the BLF 5.08HC offers just as much as the version which served as a model:

- 3 tested-and-proven wire outlet directions provide the usual flexibility for application-specific design
- 4 flange variations and the patented release latch allow the locking concept to be based on the requirements of the user
- Use the BLF 5.08HC and SL 5.08HC plug combination to reach the max. rated specifications

General ordering data

Type	BLF 5.08HC/18/180LR SN ...	Version	Product data	Packaging
Order No.	1014550000	PCB plug-in connector, female plug, 5.08 mm, Number of poles: 18,	IEC: 400 V / 24 A / 0.2 - 2.5 mm ²	Box
GTIN (EAN)	4032248722822	180°, PUSH IN, Spring connection, Clamping range, max. : 3.31 mm ² , Box	UL: 300 V / 18.5 A / AWG 26 - AWG 12	
Qty.	18 pc(s).			
Type	BLF 5.08HC/18/180LR SN ...	Version	Product data	Packaging
Order No.	1014290000	PCB plug-in connector, female plug, 5.08 mm, Number of poles: 18,	IEC: 400 V / 24 A / 0.2 - 2.5 mm ²	Box
GTIN (EAN)	4032248723058	180°, PUSH IN, Spring connection, Clamping range, max. : 3.31 mm ² , Box	UL: 300 V / 18.5 A / AWG 26 - AWG 12	
Qty.	18 pc(s).			

**OMNIMATE Signal - series BL/SL 5.08
SL 5.08HC/18/90LF 3.2SN BK BX**

Weidmüller Interface GmbH & Co. KG
Klingenbergstraße 26
D-32758 Detmold
Germany
Fon: +49 5231 14-0
Fax: +49 5231 14-292083
www.weidmueller.com

Mating connector (fully pluggable)**BLF 5.08HC/270LR SN**

Just as reliable as the millionfold proven original and featuring innovative details:

The BLF 5.08HC PUSH IN version of the BLZP 5.08HC female connector is not only different in terms of connection system; it also has a more compact design. Weidmüller's innovative PUSH IN spring connection system stands for the future of easy and tool-free wire connection. HC = High Current.

In terms of versatility, the BLF 5.08HC offers just as much as the version which served as a model:

- 3 tested-and-proven wire outlet directions provide the usual flexibility for application-specific design
- 4 flange variations and the patented release latch allow the locking concept to be based on the requirements of the user
- Use the BLF 5.08HC and SL 5.08HC plug combination to reach the max. rated specifications

General ordering data

Type	BLF 5.08HC/18/270LR SN ...	Version	Product data	Packaging
Order No.	1983240000	PCB plug-in connector, female plug, 5.08 mm, Number of poles: 18,	IEC: 400 V / 24 A / 0.2 - 2.5 mm ²	Box
GTIN (EAN)	4032248687336	270°, PUSH IN, Spring connection, Clamping range, max. : 3.31 mm ² ,	UL: 300 V / 18.5 A / AWG 26 - AWG	
Qty.	18 pc(s).	Box	12	
Type	BLF 5.08HC/18/270LR SN ...	Version	Product data	Packaging
Order No.	1982470000	PCB plug-in connector, female plug, 5.08 mm, Number of poles: 18,	IEC: 400 V / 24 A / 0.2 - 2.5 mm ²	Box
GTIN (EAN)	4032248686568	270°, PUSH IN, Spring connection, Clamping range, max. : 3.31 mm ² ,	UL: 300 V / 18.5 A / AWG 26 - AWG	
Qty.	18 pc(s).	Box	12	

BLZP 5.08HC/270F SN

Female plugs with clamping-yoke connection for connecting wires with a right-angle (90° or 270°) outlet direction. The female connectors provide space for labelling and can be coded. Fastened by means of a flange or release latch. They also provide an integrated plus/minus screw, protection against faulty insertion of the wire, and they are delivered with open clamping yokes. HC = High Current.

General ordering data

Type	BLZP 5.08HC/18/270F SN ...	Version	Product data	Packaging
Order No.	1950470000	PCB plug-in connector, female plug, 5.08 mm, Number of poles: 18,	IEC: 400 V / 23 A / 0.2 - 4 mm ²	Box
GTIN (EAN)	4032248628599	270°, Clamping yoke connection, Clamping range, max. : 4 mm ² , Box	UL: 300 V / 20 A / AWG 26 - AWG 12	
Qty.	18 pc(s).			
Type	BLZP 5.08HC/18/270F SN ...	Version	Product data	Packaging
Order No.	1950750000	PCB plug-in connector, female plug, 5.08 mm, Number of poles: 18,	IEC: 400 V / 23 A / 0.2 - 4 mm ²	Box
GTIN (EAN)	4032248629152	270°, Clamping yoke connection, Clamping range, max. : 4 mm ² , Box	UL: 300 V / 20 A / AWG 26 - AWG 12	
Qty.	18 pc(s).			

**OMNIMATE Signal - series BL/SL 5.08
SL 5.08HC/18/90LF 3.2SN BK BX**

Weidmüller Interface GmbH & Co. KG
Klingenbergstraße 26
D-32758 Detmold
Germany
Fon: +49 5231 14-0
Fax: +49 5231 14-292083
www.weidmueller.com

Mating connector (fully pluggable)
BLL 5.08/90FI

Female header for PCB mounting. The solder pin length is optimised for wave flow soldering.

General ordering data

Type	BLL 5.08/18/90FI 3.2SN ...	Version	Product data	Packaging
Order No.	1843910000	PCB plug-in connector, female header, Inverted flange, THT solder	IEC: 400 V / 23 A	Box
GTIN (EAN)	4032248355662	connection, 5.08 mm, Number of poles: 18, 90°, Solder pin length (l):	UL: 300 V / 15 A	
Qty.	18 pc(s).	3.2 mm, tinned, orange, Box		

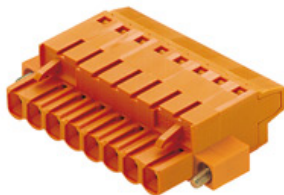
BLT 5.08HC/180F

Female plugs with TOP screw connection system for connecting wires with straight outlet direction and screw flange. The female connectors provide space for labelling and can be coded. HC = High Current.

General ordering data

Type	BLT 5.08HC/18/180F SN B ...	Version	Product data	Packaging
Order No.	1844380000	PCB plug-in connector, female plug, 5.08 mm, Number of poles: 18,	IEC: 400 V / 27 A / 0.2 - 2.5 mm ²	Box
GTIN (EAN)	4032248356317	180°, TOP connection, Clamping range, max. : 2.5 mm ² , Box	UL: 300 V / 17 A / AWG 26 - AWG 14	
Qty.	18 pc(s).			
Type	BLT 5.08HC/18/180F SN O ...	Version	Product data	Packaging
Order No.	1844150000	PCB plug-in connector, female plug, 5.08 mm, Number of poles: 18,	IEC: 400 V / 27 A / 0.2 - 2.5 mm ²	Box
GTIN (EAN)	4032248356072	180°, TOP connection, Clamping range, max. : 2.5 mm ² , Box	UL: 300 V / 17 A / AWG 26 - AWG 14	
Qty.	18 pc(s).			

**OMNIMATE Signal - series BL/SL 5.08
SL 5.08HC/18/90LF 3.2SN BK BX**

Weidmüller Interface GmbH & Co. KG
Klingenbergstraße 26
D-32758 Detmold
Germany
Fon: +49 5231 14-0
Fax: +49 5231 14-292083
www.weidmueller.com

Mating connector (fully pluggable)
BLF 5.08HC/90LR SN

Just as reliable as the millionfold proven original and featuring innovative details:

The BLF 5.08HC PUSH IN version of the BLZP 5.08HC female connector is not only different in terms of connection system; it also has a more compact design. Weidmüller's innovative PUSH IN spring connection system stands for the future of easy and tool-free wire connection. HC = High Current.

In terms of versatility, the BLF 5.08HC offers just as much as the version which served as a model:

- 3 tested-and-proven wire outlet directions provide the usual flexibility for application-specific design
- 4 flange variations and the patented release latch allow the locking concept to be based on the requirements of the user
- Use the BLF 5.08HC and SL 5.08HC plug combination to reach the max. rated specifications

General ordering data

Type	BLF 5.08HC/18/90LR SN B ...	Version	Product data	Packaging
Order No.	1000570001	PCB plug-in connector, female plug, 5.08 mm, Number of poles: 18,	IEC: 400 V / 24 A / 0.2 - 2.5 mm ²	Box
GTIN (EAN)	4032248690534	90°, PUSH IN, Spring connection, Clamping range, max. : 3.31 mm ² ,	UL: 300 V / 18.5 A / AWG 26 - AWG	
Qty.	18 pc(s).	Box	12	
Type	BLF 5.08HC/18/90LR SN O ...	Version	Product data	Packaging
Order No.	1002440000	PCB plug-in connector, female plug, 5.08 mm, Number of poles: 18,	IEC: 400 V / 24 A / 0.2 - 2.5 mm ²	Box
GTIN (EAN)	4032248694600	90°, PUSH IN, Spring connection, Clamping range, max. : 3.31 mm ² ,	UL: 300 V / 18.5 A / AWG 26 - AWG	
Qty.	18 pc(s).	Box	12	

BLF 5.08HC/180F SN

Just as reliable as the millionfold proven original and featuring innovative details:

The BLF 5.08HC PUSH IN version of the BLZP 5.08HC female connector is not only different in terms of connection system; it also has a more compact design. Weidmüller's innovative PUSH IN spring connection system stands for the future of easy and tool-free wire connection. HC = High Current.

In terms of versatility, the BLF 5.08HC offers just as much as the version which served as a model:

- 3 tested-and-proven wire outlet directions provide the usual flexibility for application-specific design
- 4 flange variations and the patented release latch allow the locking concept to be based on the requirements of the user
- Use the BLF 5.08HC and SL 5.08HC plug combination to reach the max. rated specifications

General ordering data

Type	BLF 5.08HC/18/180F SN B ...	Version	Product data	Packaging
Order No.	1012990000	PCB plug-in connector, female plug, 5.08 mm, Number of poles: 18,	IEC: 400 V / 24 A / 0.2 - 2.5 mm ²	Box
GTIN (EAN)	4032248720750	180°, PUSH IN, Spring connection, Clamping range, max. : 3.31 mm ² ,	UL: 300 V / 18.5 A / AWG 26 - AWG	
Qty.	18 pc(s).	Box	12	

**OMNIMATE Signal - series BL/SL 5.08
SL 5.08HC/18/90LF 3.2SN BK BX**

Weidmüller Interface GmbH & Co. KG
Klingenbergstraße 26
D-32758 Detmold
Germany
Fon: +49 5231 14-0
Fax: +49 5231 14-292083
www.weidmueller.com

Mating connector (fully pluggable)

Type	BLF 5.08HC/18/180F SN O ...	Version	Product data	Packaging
Order No.	1013260000	PCB plug-in connector, female plug, 5.08 mm, Number of poles: 18,	IEC: 400 V / 24 A / 0.2 - 2.5 mm ²	Box
GTIN (EAN)	4032248721009	180°, PUSH IN, Spring connection, Clamping range, max. : 3.31 mm ² ,	UL: 300 V / 18.5 A / AWG 26 - AWG	
Qty.	18 pc(s).	Box	12	

BLT 5.08HC/180LR

Female plugs with TOP screw connection system for connecting wires with straight wire outlet and release latch mechanism. The female connectors provide space for labelling and can be coded. HC = High Current.

General ordering data

Type	BLT 5.08HC/18/180LR SN ...	Version	Product data	Packaging
Order No.	1894290000	PCB plug-in connector, female plug, 5.08 mm, Number of poles: 18,	IEC: 400 V / 27 A / 0.2 - 2.5 mm ²	Box
GTIN (EAN)	4032248508631	180°, TOP connection, Clamping range, max. : 2.5 mm ² , Box	UL: 300 V / 17 A / AWG 26 - AWG 14	
Qty.	18 pc(s).			
Type	BLT 5.08HC/18/180LR SN ...	Version	Product data	Packaging
Order No.	1890380000	PCB plug-in connector, female plug, 5.08 mm, Number of poles: 18,	IEC: 400 V / 27 A / 0.2 - 2.5 mm ²	Box
GTIN (EAN)	4032248498864	180°, TOP connection, Clamping range, max. : 2.5 mm ² , Box	UL: 300 V / 17 A / AWG 26 - AWG 14	
Qty.	18 pc(s).			

BLZP 5.08HC/90LR

Female plugs with clamping-yoke connection for connecting wires with a right-angle (90° or 270°) outlet direction. The female connectors provide space for labelling and can be coded. Fastened by means of a flange or release latch. They also provide an integrated plus/minus screw, protection against faulty insertion of the wire, and they are delivered with open clamping yokes. HC = High Current.

General ordering data

Type	BLZP 5.08HC/18/90LR SN ...	Version	Product data	Packaging
Order No.	1087180000	PCB plug-in connector, female plug, 5.08 mm, Number of poles: 18,	IEC: 400 V / 23 A / 0.2 - 4 mm ²	Box
GTIN (EAN)	4032248853861	90°, Clamping yoke connection, Clamping range, max. : 4 mm ² , Box	UL: 300 V / 20 A / AWG 26 - AWG 12	
Qty.	18 pc(s).			
Type	BLZP 5.08HC/18/90LR SN ...	Version	Product data	Packaging
Order No.	1087410000	PCB plug-in connector, female plug, 5.08 mm, Number of poles: 18,	IEC: 400 V / 23 A / 0.2 - 4 mm ²	Box
GTIN (EAN)	4032248854042	90°, Clamping yoke connection, Clamping range, max. : 4 mm ² , Box	UL: 300 V / 20 A / AWG 26 - AWG 12	
Qty.	18 pc(s).			

**OMNIMATE Signal - series BL/SL 5.08
SL 5.08HC/18/90LF 3.2SN BK BX**

Weidmüller Interface GmbH & Co. KG
Klingenbergstraße 26
D-32758 Detmold
Germany
Fon: +49 5231 14-0
Fax: +49 5231 14-292083
www.weidmuller.com

Mating connector (fully pluggable)
BLZP 5.08HC/270LR SN

Female plugs with clamping-yoke connection for connecting wires with a right-angle (90° or 270°) outlet direction. The female connectors provide space for labelling and can be coded. Fastened by means of a flange or release latch. They also provide an integrated plus/minus screw, protection against faulty insertion of the wire, and they are delivered with open clamping yokes. HC = High Current.

General ordering data

Type	BLZP 5.08HC/18/270LR SN ...	Version	Product data	Packaging
Order No.	1947690000	PCB plug-in connector, female plug, 5.08 mm, Number of poles: 18,	IEC: 400 V / 23 A / 0.2 - 4 mm ²	Box
GTIN (EAN)	4032248624089	270°, Clamping yoke connection, Clamping range, max. : 4 mm ² , Box	UL: 300 V / 20 A / AWG 26 - AWG 12	
Qty.	18 pc(s).			
Type	BLZP 5.08HC/18/270LR SN ...	Version	Product data	Packaging
Order No.	1947920000	PCB plug-in connector, female plug, 5.08 mm, Number of poles: 18,	IEC: 400 V / 23 A / 0.2 - 4 mm ²	Box
GTIN (EAN)	4032248624416	270°, Clamping yoke connection, Clamping range, max. : 4 mm ² , Box	UL: 300 V / 20 A / AWG 26 - AWG 12	
Qty.	18 pc(s).			

BLZP 5.08HC/90F SN

Female plugs with clamping-yoke connection for connecting wires with a right-angle (90° or 270°) outlet direction. The female connectors provide space for labelling and can be coded. Fastened by means of a flange or release latch. They also provide an integrated plus/minus screw, protection against faulty insertion of the wire, and they are delivered with open clamping yokes. HC = High Current.

General ordering data

Type	BLZP 5.08HC/18/90F SN B ...	Version	Product data	Packaging
Order No.	1950200000	PCB plug-in connector, female plug, 5.08 mm, Number of poles: 18,	IEC: 400 V / 23 A / 0.2 - 4 mm ²	Box
GTIN (EAN)	4032248628131	90°, Clamping yoke connection, Clamping range, max. : 4 mm ² , Box	UL: 300 V / 20 A / AWG 26 - AWG 12	
Qty.	18 pc(s).			
Type	BLZP 5.08HC/18/90F SN O ...	Version	Product data	Packaging
Order No.	1949960000	PCB plug-in connector, female plug, 5.08 mm, Number of poles: 18,	IEC: 400 V / 23 A / 0.2 - 4 mm ²	Box
GTIN (EAN)	4032248627899	90°, Clamping yoke connection, Clamping range, max. : 4 mm ² , Box	UL: 300 V / 20 A / AWG 26 - AWG 12	
Qty.	18 pc(s).			

**OMNIMATE Signal - series BL/SL 5.08
SL 5.08HC/18/90LF 3.2SN BK BX**

Weidmüller Interface GmbH & Co. KG
Klingenbergstraße 26
D-32758 Detmold
Germany
Fon: +49 5231 14-0
Fax: +49 5231 14-292083
www.weidmuller.com

Mating connector (fully pluggable)
BLZP 5.08HC/180LR SN

Female plug with clamping-yoke screw system for connecting wires with straight (180°) outlet direction. The female connectors provide space for labelling and can be coded. Fastened by means of a flange or release latch. They also provide an integrated plus/minus screw, protection against faulty insertion of the wire, and they are delivered with open clamping yokes. HC = High Current.

General ordering data

Type	BLZP 5.08HC/18/180LR SN ...	Version	Product data	Packaging
Order No.	1945220000	PCB plug-in connector, female plug, 5.08 mm, Number of poles: 18,	IEC: 400 V / 23 A / 0.2 - 4 mm ²	Box
GTIN (EAN)	4032248620364	180°, Clamping yoke connection, Clamping range, max. : 4 mm ² , Box	UL: 300 V / 20 A / AWG 26 - AWG 12	
Qty.	18 pc(s).			
Type	BLZP 5.08HC/18/180LR SN ...	Version	Product data	Packaging
Order No.	1944990000	PCB plug-in connector, female plug, 5.08 mm, Number of poles: 18,	IEC: 400 V / 23 A / 0.2 - 4 mm ²	Box
GTIN (EAN)	4032248620098	180°, Clamping yoke connection, Clamping range, max. : 4 mm ² , Box	UL: 300 V / 20 A / AWG 26 - AWG 12	
Qty.	18 pc(s).			

BLF 5.08HC/270F SN

Just as reliable as the millionfold proven original and featuring innovative details:
The BLF 5.08HC PUSH IN version of the BLZP 5.08HC female connector is not only different in terms of connection system; it also has a more compact design. Weidmüller's innovative PUSH IN spring connection system stands for the future of easy and tool-free wire connection. HC = High Current.
In terms of versatility, the BLF 5.08HC offers just as much as the version which served as a model:

- 3 tested-and-proven wire outlet directions provide the usual flexibility for application-specific design
- 4 flange variations and the patented release latch allow the locking concept to be based on the requirements of the user
- Use the BLF 5.08HC and SL 5.08HC plug combination to reach the max. rated specifications

General ordering data

Type	BLF 5.08HC/18/270F SN B ...	Version	Product data	Packaging
Order No.	1982280000	PCB plug-in connector, female plug, 5.08 mm, Number of poles: 18,	IEC: 400 V / 24 A / 0.2 - 2.5 mm ²	Box
GTIN (EAN)	4032248686377	270°, PUSH IN, Spring connection, Clamping range, max. : 3.31 mm ² , Box	UL: 300 V / 18.5 A / AWG 26 - AWG 12	
Qty.	18 pc(s).			
Type	BLF 5.08HC/18/270F SN O ...	Version	Product data	Packaging
Order No.	1983050000	PCB plug-in connector, female plug, 5.08 mm, Number of poles: 18,	IEC: 400 V / 24 A / 0.2 - 2.5 mm ²	Box
GTIN (EAN)	4032248687145	270°, PUSH IN, Spring connection, Clamping range, max. : 3.31 mm ² , Box	UL: 300 V / 18.5 A / AWG 26 - AWG 12	
Qty.	18 pc(s).			

**OMNIMATE Signal - series BL/SL 5.08
SL 5.08HC/18/90LF 3.2SN BK BX**

Weidmüller Interface GmbH & Co. KG
 Klingenbergstraße 26
 D-32758 Detmold
 Germany
 Fon: +49 5231 14-0
 Fax: +49 5231 14-292083
 www.weidmueller.com

Mating connector (fully pluggable)
BLF 5.08HC/90F SN

Just as reliable as the millionfold proven original and featuring innovative details:

The BLF 5.08HC PUSH IN version of the BLZP 5.08HC female connector is not only different in terms of connection system; it also has a more compact design. Weidmüller's innovative PUSH IN spring connection system stands for the future of easy and tool-free wire connection. HC = High Current.

In terms of versatility, the BLF 5.08HC offers just as much as the version which served as a model:

- 3 tested-and-proven wire outlet directions provide the usual flexibility for application-specific design
- 4 flange variations and the patented release latch allow the locking concept to be based on the requirements of the user
- Use the BLF 5.08HC and SL 5.08HC plug combination to reach the max. rated specifications

General ordering data

Type	BLF 5.08HC/18/90F SN OR ...	Version	Product data	Packaging
Order No.	1002250000	PCB plug-in connector, female plug, 5.08 mm, Number of poles: 18,	IEC: 400 V / 24 A / 0.2 - 2.5 mm ²	Box
GTIN (EAN)	4032248694402	90°, PUSH IN, Spring connection, Clamping range, max. : 3.31 mm ² ,	UL: 300 V / 18.5 A / AWG 26 - AWG	
Qty.	18 pc(s).	Box	12	
Type	BLF 5.08HC/18/90F SN BK ...	Version	Product data	Packaging
Order No.	1000380001	PCB plug-in connector, female plug, 5.08 mm, Number of poles: 18,	IEC: 400 V / 24 A / 0.2 - 2.5 mm ²	Box
GTIN (EAN)	4032248690343	90°, PUSH IN, Spring connection, Clamping range, max. : 3.31 mm ² ,	UL: 300 V / 18.5 A / AWG 26 - AWG	
Qty.	18 pc(s).	Box	12	

OMNIMATE Signal - series BL/SL 5.08 SL 5.08HC/18/90LF 3.2SN BK BX

Weidmüller Interface GmbH & Co. KG
 Klingenbergstraße 26
 D-32758 Detmold
 Germany
 Fon: +49 5231 14-0
 Fax: +49 5231 14-292083
 www.weidmueller.com

Accessories

Blocks for PCB mounting



Minor component, major effect:

Clip-on attachment elements increase the mechanical resilience of the whole plug connection by

- securing the male connectors to the circuit board
- providing a vibration-proof connection between the sockets and the male connectors

Clip-on or pre-assembled - always the right solution:

- Hard-wearing, precise fitting dovetail joint
- Hard-wearing metal threaded inserts
- Suitable for all outlet directions

Maximum stability, minimum effort:

- Extremely resilient for frequent fastening operations
- Complete set for easy selection

The result: soldering points, contacts and overall module are more resilient against mechanical stress such as vibrations and tensile loads.

General ordering data

Type	SLA BB11R OR	Version	Product data	Packaging
Order No.	1604120000	PCB plug-in connector, Accessories, Mounting block, orange, Number		Box
GTIN (EAN)	4008190182977	of poles: 1		
Qty.	20 pc(s).			
Type	SLA BB11R SW	Version	Product data	Packaging
Order No.	1692340000	PCB plug-in connector, Accessories, Mounting block, black, Number of		Box
GTIN (EAN)	4008190864965	poles: 1		
Qty.	20 pc(s).			

**OMNIMATE Signal - series BL/SL 5.08
SL 5.08HC/18/90LF 3.2SN BK BX**

Weidmüller Interface GmbH & Co. KG
 Klingenbergstraße 26
 D-32758 Detmold
 Germany
 Fon: +49 5231 14-0
 Fax: +49 5231 14-292083
 www.weidmueller.com

Accessories**LED Light guides****Effective: the link between LED and front panel.**

Floodlight indicators allow users to monitor the switching states without requiring a special design: optical plastic directs the light from standard LEDs around a bend into the connectors or through the front plate.

The fibre-optic elements are simply clipped behind the relevant 90° bend male connectors (90° outlet direction). Versions with different incoming light beam heights achieve maximum light efficiency for LEDs with different designs or heights.

The advantages compared to conventional solutions:

- No additional LED circuit board required behind the front panel
- No "long-legged" LEDs with separate mounting required
- Bent fibre-optic cable line for maximum light efficiency
- Uncomplicated front plate bore holes due to circular shape of outgoing light beam
- Easy to maintain correct clearance and creepage distance
- Can be partitioned for smaller pole numbers

The result: simplified manufacturing process, reduced costs and simplified design

General ordering data

Type	SL FLA 3.8/1	Version	Product data	Packaging
Order No.	1580110000	PCB plug-in connector, Accessories, Flood-light display, Transparent,		Box
GTIN (EAN)	4008190050740	Number of poles: 1		
Qty.	100 pc(s).			
Type	SL FLA 2,3/1	Version	Product data	Packaging
Order No.	1636670000	PCB plug-in connector, Accessories, Flood-light display, Transparent,		Box
GTIN (EAN)	4008190409975	Number of poles: 1		
Qty.	100 pc(s).			
Type	SL FLA 2,3/24	Version	Product data	Packaging
Order No.	1636680000	PCB plug-in connector, Accessories, Flood-light display, Transparent,		Box
GTIN (EAN)	4008190409968	Number of poles: 1		
Qty.	10 pc(s).			
Type	SL FLA 3.8/24	Version	Product data	
Order No.	1595860000	PCB plug-in connector, Accessories, Flood-light display, Transparent,		
GTIN (EAN)	4008190140892	Number of poles: 1		
Qty.	10 pc(s).			
Type	SL FLA 9.0/24	Version	Product data	
Order No.	1595870000	PCB plug-in connector, Accessories, Flood-light display, Transparent,		
GTIN (EAN)	4008190079796	Number of poles: 1		
Qty.	10 pc(s).			
Type	SL FLA 9.0/1	Version	Product data	Packaging
Order No.	1580120000	PCB plug-in connector, Accessories, Flood-light display, Transparent,		Box
GTIN (EAN)	4008190031909	Number of poles: 1		
Qty.	100 pc(s).			

Data sheet

OMNIMATE Signal - series BL/SL 5.08 SL 5.08HC/18/90LF 3.2SN BK BX

Weidmüller Interface GmbH & Co. KG
 Klingenbergstraße 26
 D-32758 Detmold
 Germany
 Fon: +49 5231 14-0
 Fax: +49 5231 14-292083
 www.weidmueller.com

Accessories

Type	SL FLA 1.5/1	Version	Product data	Packaging
Order No.	1580100000	PCB plug-in connector, Accessories, Flood-light display, Transparent,		Box
GTIN (EAN)	4008190152475	Number of poles: 1		
Qty.	100 pc(s).			
Type	SL FLA 1.5/24	Version	Product data	
Order No.	1595850000	PCB plug-in connector, Accessories, Flood-light display, Transparent,		
GTIN (EAN)	4008190092573	Number of poles: 1		
Qty.	10 pc(s).			

Coding elements



Only connects what is supposed to be connected: the right connection at the right place.

Coding elements and locking devices clearly assign connecting elements during the manufacturing process and operation

The coding elements and locking devices are inserted prior to assembly or during the cable assembly phase. The Weidmüller alternative: configure online using the variant configurator to precode prior to delivery.

Incorrect assembly on the circuit board and incorrect plugging of connecting elements is no longer possible. The advantage: no troubleshooting during manufacture and no operational errors by the user.

General ordering data

Type	BLZ/SL KO OR BX	Version	Product data	Packaging
Order No.	1573010000	PCB plug-in connector, Accessories, Coding element, orange, Number		Box
GTIN (EAN)	4008190048396	of poles: 1		
Qty.	100 pc(s).			
Type	BLZ/SL KO BK BX	Version	Product data	Packaging
Order No.	1545710000	PCB plug-in connector, Accessories, Coding element, black, Number		Box
GTIN (EAN)	4008190087142	of poles: 1		
Qty.	50 pc(s).			

OMNIMATE Signal - series BL/SL 5.08 SL 5.08HC/18/90LF 3.2SN BK BX

Weidmüller Interface GmbH & Co. KG
 Klingenbergstraße 26
 D-32758 Detmold
 Germany
 Fon: +49 5231 14-0
 Fax: +49 5231 14-292083
 www.weidmueller.com

Accessories

Additional accessories



No task is too small when creating the perfect solution.

Connections form just one part of the overall process. Small details are often the key to the perfect solution in applications where potentials are tested, grouped or even isolated.

A system is not a system without small but useful details:

- Test plugs - ensure reliable pick-up from diagnostic sockets
- Cross-connectors - ensure a stable electrical distribution contact directly at the connection
- Compartment partition elements - divide a large number of male connectors into several separate socket connector channels
- Locks and clips - optional vibration-resistant clip-on connection or mounting for male and female connectors

In tandem with the manufacturing process and application - more accessories = smaller workload

General ordering data

Type	SL AT SW	Version	Product data	Packaging
Order No.	1770240000	PCB plug-in connector, Accessories, Spacer, black, Number of poles: 1		Box
GTIN (EAN)	4032248117710			
Qty.	100 pc(s).			
Type	SL AT OR	Version	Product data	Packaging
Order No.	1598300000	PCB plug-in connector, Accessories, Spacer, orange, Number of poles: 1		Box
GTIN (EAN)	4008190189266			
Qty.	100 pc(s).			

Data sheet**OMNIMATE Signal - series BL/SL 5.08
SL 5.08HC/18/90LF 3.2SN BK BX**

Weidmüller Interface GmbH & Co. KG
Klingenbergstraße 26
D-32758 Detmold
Germany
Fon: +49 5231 14-0
Fax: +49 5231 14-292083
www.weidmueller.com

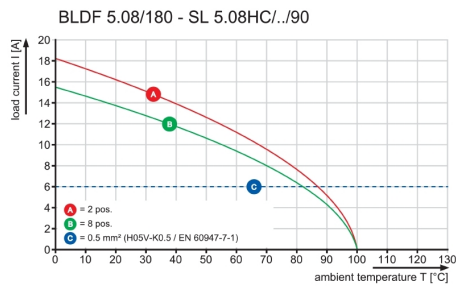
Drawings**Graph**

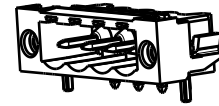
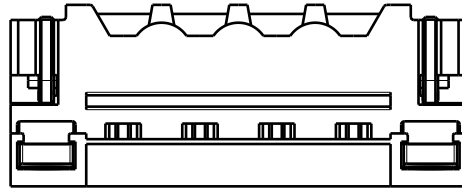
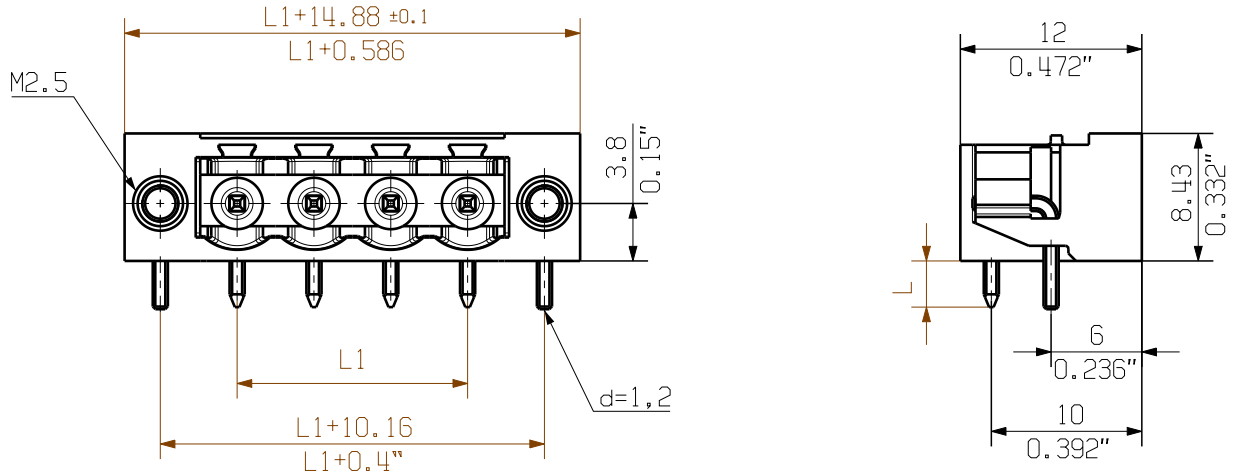

1/1

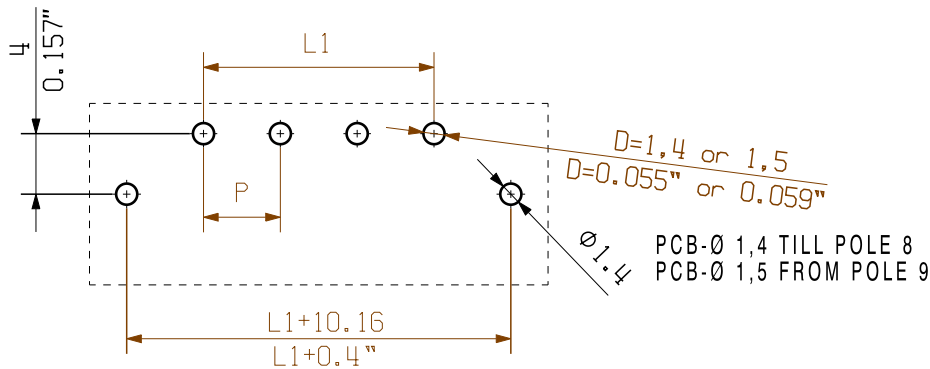

HOLE PATTERN

For the mounting of PCBs, it should be noted that the rated data relates only to the PCB components alone. The necessary creepage and clearance paths must be observed in connection with the respective applicant in accordance to IEC 664 / VDE 0110. The current-carrying capacity and pitch tolerance is to be determined according to DIN IEC 326 part 3 very fine.

Weidmüller PCB components are tested to the DIN EN 61984 standard, and are valid for its field of application. Provided that the components are used to the intended purpose, all requirements with respect to the occurring of electrical, mechanical, thermic and corrosive stress will be satisfied.

P = PITCH
SHOWN: SL 5.08HC/04/90LF

STIFTLAENGE L PIN LENGTH L	TOLERANZ TOLERANCE			
3,2	0,1	24	116,84	4,600
	-0,3	23	111,76	4,400
4,5	0,1	22	106,68	4,200
	-0,3	21	101,60	4,000
		20	96,52	3,800
		19	91,44	3,600
		18	86,36	3,400
		17	81,28	3,200
		16	76,20	3,000
		15	71,12	2,800
		14	66,04	2,600
		13	60,96	2,400
		12	55,88	2,200
		11	50,80	2,000
		10	45,72	1,800
		9	40,64	1,600
		8	35,56	1,400
		7	30,48	1,200
		6	25,40	1,000
		5	20,32	0,800
		4	15,24	0,600
		3	10,16	0,400
		2	5,08	0,200
		n	L1 [mm]	L1 [inch]

	DIN ISO 2768-m	101482/5 07.02.18 HELIS_MA 01		Cat.no.: . . .		
	Modification				3 48753 04	
		Date	Name	Drawing no. Issue no.		
Scale: 2:1		Drawn	18.10.2010	HERTEL_S	Sheet 05	of 05 sheets
Supersedes: .		Responsible		HERTEL_S	SL 5.08HC/.. /90... STIFTLIESTE MALE HEADER	
		Checked	27.02.2018	HELIS_MA		
		Approved		LANG_T	Product file: SL-HP 5.08 7377	

The reproduction, distribution and utilization of this document as well as the communication of its contents without explicit authorization is prohibited. Offenders will be held liable for the payment of damages. Weidmüller exclusively reserves the right to file for patents, utility models or designs.

© Weidmüller Interface GmbH & Co. KG

Recommended wave soldering profiles

Weidmüller Interface GmbH & Co. KG
 Klängenbergstraße 16
 D-32758 Detmold
 Germany
 Fon: +49 5231 14-0
 Fax: +49 5231 14-292083
 www.weidmueller.com

Single Wave:

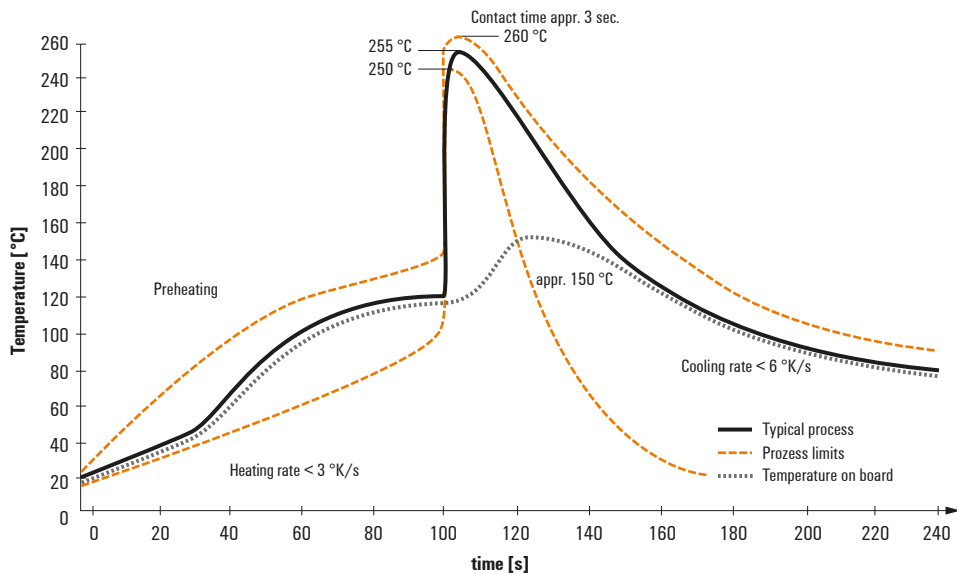

Double Wave:

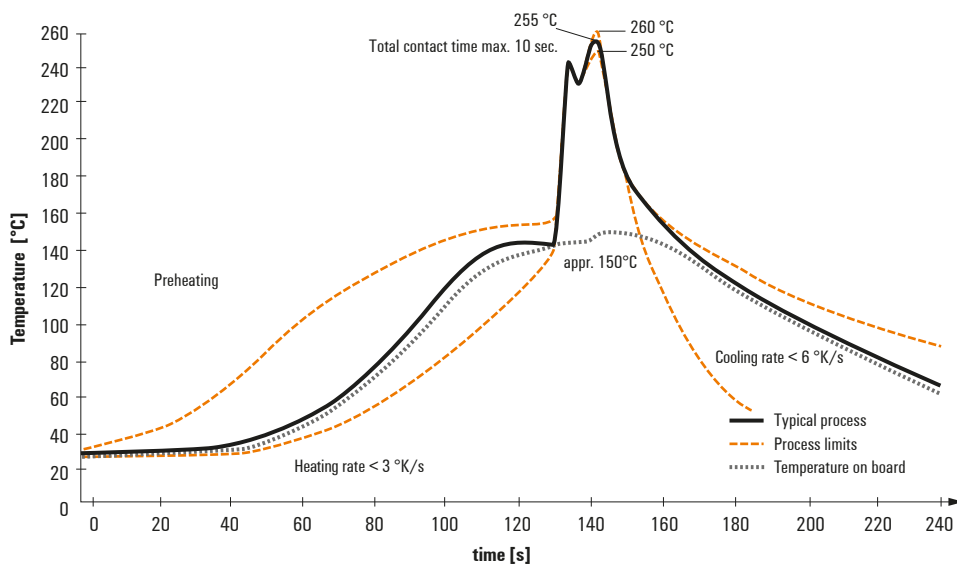

Wave soldering profiles

Wired connection elements should be processed in accordance with the DIN EN 61760-1 standard. We have included two recommendations for practical wave soldering profiles, with which Weidmüller PCB terminals and connectors are qualified.

When choosing a suitable profile for your application, the following factors also need to be considered:

- PCB thickness
- Proportion of Cu in the layers
- Single/double-sided assembly
- Product range
- Heating and cooling rates

The single and double wave profiles each indicate the recommended operating range, including the maximum soldering temperature of 260°C. In practice, the maximum soldering temperature is quite often well below the above maximum profile.