

## OMNIMATE Signal - series BL/SL 5.08 SL 5.08HC/02/180G 3.2SN OR BX

**Weidmüller Interface GmbH & Co. KG**  
Klingenbergstraße 26  
D-32758 Detmold  
Germany  
Fon: +49 5231 14-0  
Fax: +49 5231 14-292083  
www.weidmueller.com

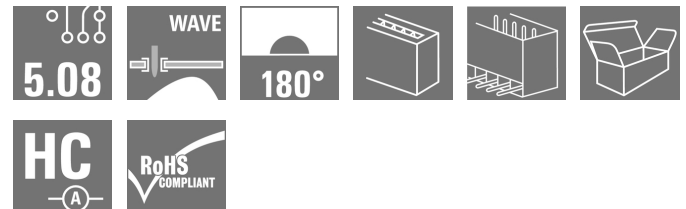
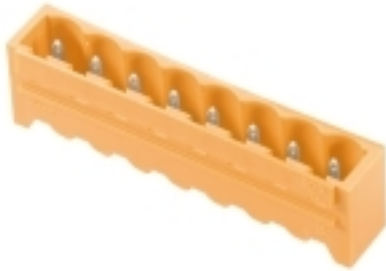

Similar to illustration

Pin headers in glass-fibre-reinforced plastic with straight wire outlet; optimised for wave soldering. The flange variant (F) can be screwed onto the respective counter piece or the circuit board. There is no need for an extra screw to connect the circuit board when the solder flange (LF) version is used. This also protects the solder points from mechanical strain. All pin headers can be manually coded or ordered pre-coded. HC = High Current.

### General ordering data

Type	SL 5.08HC/02/180G 3.2SN OR BX
Order No.	<a href="#">1146730000</a>
Version	PCB plug-in connector, male header, closed side, THT solder connection, 5.08 mm, Number of poles: 2, 180°, Solder pin length (l): 3.2 mm, tinned, orange, Box
GTIN (EAN)	4032248108688
Qty.	100 pc(s).
Product data	IEC: 400 V / 24 A UL: 300 V / 18.5 A
Packaging	Box

Creation date May 2, 2020 1:46:52 AM CEST

**OMNIMATE Signal - series BL/SL 5.08  
SL 5.08HC/02/180G 3.2SN OR BX**

**Weidmüller Interface GmbH & Co. KG**  
 Klingenbergstraße 26  
 D-32758 Detmold  
 Germany  
 Fon: +49 5231 14-0  
 Fax: +49 5231 14-292083  
 www.weidmueller.com

**Technical data****Dimensions and weights**

Width	13.36 mm	Width (inches)	0.526 inch
Height	15.2 mm	Height (inches)	0.598 inch
Height of lowest version	12 mm	Depth	8.5 mm
Depth (inches)	0.335 inch	Net weight	1.23 g

**System specifications**

Product family	OMNIMATE Signal - series BL/SL 5.08	Type of connection	Board connection
Mounting onto the PCB	THT solder connection	Pitch in mm (P)	5.08 mm
Pitch in inches (P)	0.2 inch	Outgoing elbow	180°
Number of poles	2	Number of solder pins per pole	1
Solder pin length (l)	3.2 mm	Solder pin length tolerance	+0.1 / -0.3 mm
Tolerance of solder pin position	± 0.1 mm	Solder pin dimensions	d = 1.2 mm, Octagonal
Solder pin dimensions = d tolerance	0 / -0,03 mm	Solder eyelet hole diameter (D)	1.3 mm
Solder eyelet hole diameter tolerance (D)+	0,1 mm	L1 in mm	5.08 mm
L1 in inches	0.2 inch	Number of rows	1
Pin series quantity	1	Volume resistance	≤ 5mΩ
Can be coded	Yes	Plugging cycles	25
Plugging force/pole, max.	10 N	Pulling force/pole, max.	7.5 N

**Material data**

Insulating material	PA GF	Colour	orange
Colour chart (similar)	RAL 2000	Insulating material group	II
Comparative Tracking Index (CTI)	≥ 550	Insulation strength	≥ 10 <sup>8</sup> Ω
UL 94 flammability rating	V-0	GWFI	960 °C
Contact material	CuMg	Contact surface	tinned
Layer structure of solder connection	1-3 μm Ni / 2-4 μm Sn matt	Layer structure of plug contact	1-3 μm Ni / 2-4 μm Sn matt
Storage temperature, min.	-25 °C	Storage temperature, max.	50 °C
Max. relative humidity during storage	70 %	Operating temperature, min.	-50 °C
Operating temperature, max.	100 °C	Temperature range, installation, min.	-25 °C
Temperature range, installation, max.	100 °C		

**Rated data acc. to IEC**

tested acc. to standard	IEC 60664-1, IEC 61984	Rated current, min. number of poles (Tu=20°C)	24 A
Rated current, max. number of poles (Tu=20°C)	19 A	Rated current, min. number of poles (Tu=40°C)	21 A
Rated current, max. number of poles (Tu=40°C)	16.5 A	Rated voltage for surge voltage class / pollution degree II/2	400 V
Rated voltage for surge voltage class / pollution degree III/2	320 V	Rated voltage for surge voltage class / pollution degree III/3	250 V
Rated impulse voltage for surge voltage class/ pollution degree II/2	4 kV	Rated impulse voltage for surge voltage class/ pollution degree III/2	4 kV
Rated impulse voltage for surge voltage class/ contamination degree III/3	4 kV		

**Rated data acc. to CSA**

Rated voltage (Use group B / CSA)	300 V	Rated voltage (Use group D / CSA)	300 V
Rated current (Use group B / CSA)	18.5 A	Rated current (Use group D / CSA)	18.5 A

**Data sheet**

**OMNIMATE Signal - series BL/SL 5.08  
SL 5.08HC/02/180G 3.2SN OR BX**

**Weidmüller Interface GmbH & Co. KG**  
Klingenbergstraße 26  
D-32758 Detmold  
Germany  
Fon: +49 5231 14-0  
Fax: +49 5231 14-292083  
www.weidmueller.com

**Technical data**

**Rated data acc. to UL 1059**

Institute (cURus)



Certificate No. (cURus)

E60693

Rated voltage (Use group B / UL 1059) 300 V

Rated voltage (Use group D / UL 1059) 300 V

Rated current (Use group B / UL 1059) 18.5 A

Rated current (Use group D / UL 1059) 10 A

Reference to approval values  
Specifications are maximum values, details - see approval certificate.

**Packing**

Packaging	Box	VPE length	42 mm
VPE width	68 mm	VPE height	165 mm

**Classifications**

ETIM 6.0	EC002637	ETIM 7.0	EC002637
eClass 9.0	27-44-04-02	eClass 9.1	27-44-04-02
eClass 10.0	27-44-04-02		

**Notes**

- Notes
- Additional colours on request
  - Gold-plated contact surfaces on request
  - Rated current related to rated cross-section & min. No. of poles.
  - P on drawing = pitch
  - Rated data refer only to the component itself. Clearance and creepage distances to other components are to be designed in accordance with the relevant application standards.

IPC conformity  
Conformity: The products are developed, manufactured and delivered according international recognized standards and norms and comply with the assured properties in the data sheet resp. fulfill decorative properties in accordance with IPC-A-610 "Class 2". Further claims on the products can be evaluated on request.

**Approvals**

Approvals



ROHS Conform

**Data sheet****OMNIMATE Signal - series BL/SL 5.08  
SL 5.08HC/02/180G 3.2SN OR BX**

**Weidmüller Interface GmbH & Co. KG**  
Klingenbergstraße 26  
D-32758 Detmold  
Germany  
Fon: +49 5231 14-0  
Fax: +49 5231 14-292083  
www.weidmueller.com

**Technical data****Downloads**

Approval/Certificate/Document of Conformity	<a href="#">CB Certificate</a> <a href="#">CB Testreport</a> <a href="#">Declaration of the Manufacturer</a>
Brochure/Catalogue	<a href="#">FL DRIVES EN</a> <a href="#">MB DEVICE MANUF. EN</a> <a href="#">FL DRIVES DE</a> <a href="#">CAT 2 PORTFOLIOGUIDE EN</a> <a href="#">FL BUILDING SAFETY EN</a> <a href="#">FL APPL LED LIGHTING EN</a> <a href="#">FLIndustr.CONTROLS EN</a> <a href="#">FL MACHINE SAFETY EN</a> <a href="#">FL HEATING ELECTR EN</a> <a href="#">FL APPL INVERTER EN</a> <a href="#">FL_BASE_STATION_EN</a> <a href="#">FL ELEVATOR EN</a> <a href="#">FL POWER SUPPLY EN</a> <a href="#">FL 72H SAMPLE SER EN</a> <a href="#">PO OMNIMATE EN</a>
Engineering Data	<a href="#">STEP</a>
Product Change Notification	<a href="#">EN - Change of packaging</a> <a href="#">DE - Change of packaging</a>

**OMNIMATE Signal - series BL/SL 5.08  
SL 5.08HC/02/180G 3.2SN OR BX**

**Weidmüller Interface GmbH & Co. KG**  
Klingenbergstraße 26  
D-32758 Detmold  
Germany  
Fon: +49 5231 14-0  
Fax: +49 5231 14-292083  
www.weidmueller.com

**Drawings**

**Dimensional drawing**

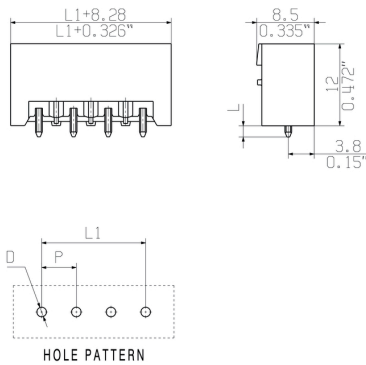

**Product benefits**



Safe power transmission  
Proven properties

**Graph**

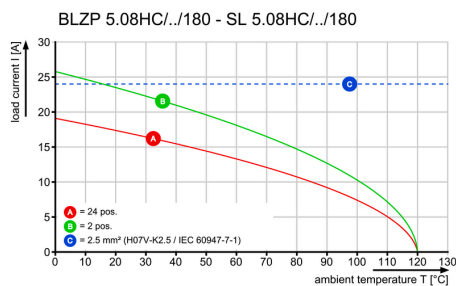

**Graph**



**Graph**



**OMNIMATE Signal - series BL/SL 5.08  
SL 5.08HC/02/180G 3.2SN OR BX**

**Weidmüller Interface GmbH & Co. KG**  
Klingenbergstraße 26  
D-32758 Detmold  
Germany  
Fon: +49 5231 14-0  
Fax: +49 5231 14-292083  
www.weidmueller.com

**Mating connector (fully pluggable)**
**BLZP 5.08HC/225 SN**

Clamping-yoke connection with right-angled (90° or 270°) or angled (225°) outlet direction. The female connectors provide space for labelling and can be coded. Fastened by means of a flange or release latch. They also provide an integrated plus/minus screw, protection against faulty insertion of the wire, and they are delivered with open clamping yokes. HC = High Current.

**General ordering data**

Type	BLZP 5.08HC/02/225 SN B ...	Version	Product data	Packaging
Order No.	<a href="#">1946560000</a>	PCB plug-in connector, female plug, 5.08 mm, Number of poles: 2,	IEC: 400 V / 17.5 A / 0.2 - 4 mm <sup>2</sup>	Box
GTIN (EAN)	4032248622337	225°, Clamping yoke connection, Clamping range, max. : 4 mm <sup>2</sup> , Box	UL: 300 V / 15 A / AWG 26 - AWG 12	
Qty.	180 pc(s).			
Type	BLZP 5.08HC/02/225 SN O ...	Version	Product data	Packaging
Order No.	<a href="#">1946250000</a>	PCB plug-in connector, female plug, 5.08 mm, Number of poles: 2,	IEC: 400 V / 17.5 A / 0.2 - 4 mm <sup>2</sup>	Box
GTIN (EAN)	4032248621828	225°, Clamping yoke connection, Clamping range, max. : 4 mm <sup>2</sup> , Box	UL: 300 V / 15 A / AWG 26 - AWG 12	
Qty.	180 pc(s).			

**BLZP 5.08HC/270 SN**

Female plugs with clamping-yoke connection for connecting wires with a right-angle (90° or 270°) outlet direction. The female connectors provide space for labelling and can be coded. Fastened by means of a flange or release latch. They also provide an integrated plus/minus screw, protection against faulty insertion of the wire, and they are delivered with open clamping yokes. HC = High Current.

**General ordering data**

Type	BLZP 5.08HC/02/270 SN O ...	Version	Product data	Packaging
Order No.	<a href="#">1948790000</a>	PCB plug-in connector, female plug, 5.08 mm, Number of poles: 2,	IEC: 400 V / 23 A / 0.2 - 4 mm <sup>2</sup>	Box
GTIN (EAN)	4032248626243	270°, Clamping yoke connection, Clamping range, max. : 4 mm <sup>2</sup> , Box	UL: 300 V / 20 A / AWG 26 - AWG 12	
Qty.	180 pc(s).			
Type	BLZP 5.08HC/02/270 SN B ...	Version	Product data	Packaging
Order No.	<a href="#">1949020000</a>	PCB plug-in connector, female plug, 5.08 mm, Number of poles: 2,	IEC: 400 V / 23 A / 0.2 - 4 mm <sup>2</sup>	Box
GTIN (EAN)	4032248626472	270°, Clamping yoke connection, Clamping range, max. : 4 mm <sup>2</sup> , Box	UL: 300 V / 20 A / AWG 26 - AWG 12	
Qty.	180 pc(s).			

**OMNIMATE Signal - series BL/SL 5.08  
SL 5.08HC/02/180G 3.2SN OR BX**

**Weidmüller Interface GmbH & Co. KG**  
Klingenbergstraße 26  
D-32758 Detmold  
Germany  
Fon: +49 5231 14-0  
Fax: +49 5231 14-292083  
www.weidmueller.com

**Mating connector (fully pluggable)**
**BLZP 5.08HC/180 SN**

Female plug with clamping-yoke screw system for connecting wires with straight (180°) outlet direction. The female connectors provide space for labelling and can be coded. Fastened by means of a flange or release latch. They also provide an integrated plus/minus screw, protection against faulty insertion of the wire, and they are delivered with open clamping yokes. HC = High Current.

**General ordering data**

Type	BLZP 5.08HC/02/180 SN O ...	Version	Product data	Packaging
Order No.	<a href="#">1943580000</a>	PCB plug-in connector, female plug, 5.08 mm, Number of poles: 2,	IEC: 400 V / 23 A / 0.2 - 4 mm <sup>2</sup>	Box
GTIN (EAN)	4032248617562	180°, Clamping yoke connection, Clamping range, max. : 4 mm <sup>2</sup> , Box	UL: 300 V / 20 A / AWG 26 - AWG 12	
Qty.	180 pc(s).			
Type	BLZP 5.08HC/02/180 SN B ...	Version	Product data	Packaging
Order No.	<a href="#">1943810000</a>	PCB plug-in connector, female plug, 5.08 mm, Number of poles: 2,	IEC: 400 V / 23 A / 0.2 - 4 mm <sup>2</sup>	Box
GTIN (EAN)	4032248617821	180°, Clamping yoke connection, Clamping range, max. : 4 mm <sup>2</sup> , Box	UL: 300 V / 20 A / AWG 26 - AWG 12	
Qty.	180 pc(s).			

**BLF 5.08HC/180 SN**

Just as reliable as the millionfold proven original and featuring innovative details:  
The BLF 5.08HC PUSH IN version of the BLZP 5.08HC female connector is not only different in terms of connection system; it also has a more compact design. Weidmüller's innovative PUSH IN spring connection system stands for the future of easy and tool-free wire connection. HC = High Current.  
In terms of versatility, the BLF 5.08HC offers just as much as the version which served as a model:

- 3 tested-and-proven wire outlet directions provide the usual flexibility for application-specific design
- 4 flange variations and the patented release latch allow the locking concept to be based on the requirements of the user
- Use the BLF 5.08HC and SL 5.08HC plug combination to reach the max. rated specifications

**General ordering data**

Type	BLF 5.08HC/02/180 SN BK ...	Version	Product data	Packaging
Order No.	<a href="#">1013430000</a>	PCB plug-in connector, female plug, 5.08 mm, Number of poles: 2,	IEC: 400 V / 24 A / 0.2 - 2.5 mm <sup>2</sup>	Box
GTIN (EAN)	4032248721580	180°, PUSH IN, Spring connection, Clamping range, max. : 3.31 mm <sup>2</sup> , Box	UL: 300 V / 18.5 A / AWG 26 - AWG 12	
Qty.	180 pc(s).			
Type	BLF 5.08HC/02/180 SN OR ...	Version	Product data	Packaging
Order No.	<a href="#">1013680000</a>	PCB plug-in connector, female plug, 5.08 mm, Number of poles: 2,	IEC: 400 V / 24 A / 0.2 - 2.5 mm <sup>2</sup>	Box
GTIN (EAN)	4032248721818	180°, PUSH IN, Spring connection, Clamping range, max. : 3.31 mm <sup>2</sup> , Box	UL: 300 V / 18.5 A / AWG 26 - AWG 12	
Qty.	180 pc(s).			

**OMNIMATE Signal - series BL/SL 5.08  
SL 5.08HC/02/180G 3.2SN OR BX**

**Weidmüller Interface GmbH & Co. KG**  
Klingenbergstraße 26  
D-32758 Detmold  
Germany  
Fon: +49 5231 14-0  
Fax: +49 5231 14-292083  
www.weidmueller.com

**Mating connector (fully pluggable)**
**BLZP 5.08HC/90 SN**

Female plugs with clamping-yoke connection for connecting wires with a right-angle (90° or 270°) outlet direction. The female connectors provide space for labelling and can be coded. Fastened by means of a flange or release latch. They also provide an integrated plus/minus screw, protection against faulty insertion of the wire, and they are delivered with open clamping yokes. HC = High Current.

**General ordering data**

Type	BLZP 5.08HC/02/90 SN OR ...	Version	Product data	Packaging
Order No.	<a href="#">1948000000</a>	PCB plug-in connector, female plug, 5.08 mm, Number of poles: 2,	IEC: 400 V / 23 A / 0.2 - 4 mm <sup>2</sup>	Box
GTIN (EAN)	4032248624225	90°, Clamping yoke connection, Clamping range, max. : 4 mm <sup>2</sup> , Box	UL: 300 V / 20 A / AWG 26 - AWG 12	
Qty.	180 pc(s).			
Type	BLZP 5.08HC/02/90 SN BK ...	Version	Product data	Packaging
Order No.	<a href="#">1948240000</a>	PCB plug-in connector, female plug, 5.08 mm, Number of poles: 2,	IEC: 400 V / 23 A / 0.2 - 4 mm <sup>2</sup>	Box
GTIN (EAN)	4032248624768	90°, Clamping yoke connection, Clamping range, max. : 4 mm <sup>2</sup> , Box	UL: 300 V / 20 A / AWG 26 - AWG 12	
Qty.	180 pc(s).			

**BLC 5.08R**

Female plugs with crimp wire connection system. The female plugs provide space for labelling and can be coded.

**General ordering data**

Type	BLC 5.08/02/180R OR BX	Version	Product data	Packaging
Order No.	<a href="#">1610490000</a>	PCB plug-in connector, female plug, 5.08 mm, Number of poles: 2,	IEC: 400 V / 21 A	Box
GTIN (EAN)	4008190057114	180°, Crimp connection, Clamping range, max. : 2.5 mm <sup>2</sup> , Box	UL: 300 V / 10 A / AWG 26 - AWG 14	
Qty.	100 pc(s).			
Type	BLC 5.08/02/180R BK BX	Version	Product data	Packaging
Order No.	<a href="#">1711960000</a>	PCB plug-in connector, female plug, 5.08 mm, Number of poles: 2,	IEC: 400 V / 21 A	Box
GTIN (EAN)	4008190934972	180°, Crimp connection, Clamping range, max. : 2.5 mm <sup>2</sup> , Box	UL: 300 V / 10 A / AWG 26 - AWG 14	
Qty.	100 pc(s).			



**OMNIMATE Signal - series BL/SL 5.08  
SL 5.08HC/02/180G 3.2SN OR BX**

**Weidmüller Interface GmbH & Co. KG**  
Klingenbergstraße 26  
D-32758 Detmold  
Germany  
Fon: +49 5231 14-0  
Fax: +49 5231 14-292083  
www.weidmueller.com

**Mating connector (fully pluggable)**
**BLF 5.08HC/90 SN**

Just as reliable as the millionfold proven original and featuring innovative details:  
The BLF 5.08HC PUSH IN version of the BLZP 5.08HC female connector is not only different in terms of connection system; it also has a more compact design. Weidmüller's innovative PUSH IN spring connection system stands for the future of easy and tool-free wire connection. HC = High Current.  
In terms of versatility, the BLF 5.08HC offers just as much as the version which served as a model:

- 3 tested-and-proven wire outlet directions provide the usual flexibility for application-specific design
- 4 flange variations and the patented release latch allow the locking concept to be based on the requirements of the user
- Use the BLF 5.08HC and SL 5.08HC plug combination to reach the max. rated specifications

**General ordering data**

Type	BLF 5.08HC/02/90 SN BK ...	Version	Product data	Packaging
Order No.	<a href="#">1000030001</a>	PCB plug-in connector, female plug, 5.08 mm, Number of poles: 2,	IEC: 400 V / 24 A / 0.2 - 2.5 mm <sup>2</sup>	Box
GTIN (EAN)	4032248689965	90°, PUSH IN, Spring connection, Clamping range, max. : 3.31 mm <sup>2</sup> ,	UL: 300 V / 18.5 A / AWG 26 - AWG	
Qty.	180 pc(s).	Box	12	
Type	BLF 5.08HC/02/90 SN OR ...	Version	Product data	Packaging
Order No.	<a href="#">1001530000</a>	PCB plug-in connector, female plug, 5.08 mm, Number of poles: 2,	IEC: 400 V / 24 A / 0.2 - 2.5 mm <sup>2</sup>	Box
GTIN (EAN)	4032248693337	90°, PUSH IN, Spring connection, Clamping range, max. : 3.31 mm <sup>2</sup> ,	UL: 300 V / 18.5 A / AWG 26 - AWG	
Qty.	180 pc(s).	Box	12	

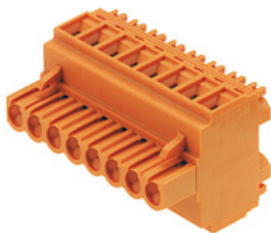
**BLDT 5.08**

Female plugs with two clamping-yoke screw connections per pole for wire connections with 90° and 270° outlet directions. The female plugs provide space for labelling and can be coded.

**General ordering data**

Type	BLDT 5.08/02/- SN BK BX	Version	Product data	Packaging
Order No.	<a href="#">1660710000</a>	PCB plug-in connector, female plug, 5.08 mm, Number of poles: 2,	IEC: 400 V / 14 A / 0.2 - 2.5 mm <sup>2</sup>	Box
GTIN (EAN)	4008190417161	180°, Clamping yoke connection, Clamping range, max. : 3.31 mm <sup>2</sup> ,	UL: 300 V / 10 A / AWG 26 - AWG 12	
Qty.	150 pc(s).	Box		
Type	BLDT 5.08/02/- SN OR BX	Version	Product data	Packaging
Order No.	<a href="#">1644730000</a>	PCB plug-in connector, female plug, 5.08 mm, Number of poles: 2,	IEC: 400 V / 14 A / 0.2 - 2.5 mm <sup>2</sup>	Box
GTIN (EAN)	4008190283940	180°, Clamping yoke connection, Clamping range, max. : 3.31 mm <sup>2</sup> ,	UL: 300 V / 10 A / AWG 26 - AWG 12	
Qty.	150 pc(s).	Box		

## OMNIMATE Signal - series BL/SL 5.08 SL 5.08HC/02/180G 3.2SN OR BX

**Weidmüller Interface GmbH & Co. KG**  
 Klingenbergstraße 26  
 D-32758 Detmold  
 Germany  
 Fon: +49 5231 14-0  
 Fax: +49 5231 14-292083  
 www.weidmueller.com

### Mating connector (fully pluggable)

#### BLF 5.08HC/270 SN



Just as reliable as the millionfold proven original and featuring innovative details:  
 The BLF 5.08HC PUSH IN version of the BLZP 5.08HC female connector is not only different in terms of connection system; it also has a more compact design. Weidmüller's innovative PUSH IN spring connection system stands for the future of easy and tool-free wire connection. HC = High Current.  
 In terms of versatility, the BLF 5.08HC offers just as much as the version which served as a model:

- 3 tested-and-proven wire outlet directions provide the usual flexibility for application-specific design
- 4 flange variations and the patented release latch allow the locking concept to be based on the requirements of the user
- Use the BLF 5.08HC and SL 5.08HC plug combination to reach the max. rated specifications

#### General ordering data

Type	BLF 5.08HC/02/270 SN BK ...	Version	Product data	Packaging
Order No.	<a href="#">1981930000</a>	PCB plug-in connector, female plug, 5.08 mm, Number of poles: 2,	IEC: 400 V / 24 A / 0.2 - 2.5 mm <sup>2</sup>	Box
GTIN (EAN)	4032248684625	270°, PUSH IN, Spring connection, Clamping range, max. : 3.31 mm <sup>2</sup> ,	UL: 300 V / 18.5 A / AWG 26 - AWG	
Qty.	180 pc(s).	Box	12	
Type	BLF 5.08HC/02/270 SN OR ...	Version	Product data	Packaging
Order No.	<a href="#">1982700000</a>	PCB plug-in connector, female plug, 5.08 mm, Number of poles: 2,	IEC: 400 V / 24 A / 0.2 - 2.5 mm <sup>2</sup>	Box
GTIN (EAN)	4032248686797	270°, PUSH IN, Spring connection, Clamping range, max. : 3.31 mm <sup>2</sup> ,	UL: 300 V / 18.5 A / AWG 26 - AWG	
Qty.	180 pc(s).	Box	12	

#### BLZP 5.08HC/225B SN



Clamping-yoke connection with right-angled (90° or 270°) or angled (225°) outlet direction. The female connectors provide space for labelling and can be coded. Fastened by means of a flange or release latch. They also provide an integrated plus/minus screw, protection against faulty insertion of the wire, and they are delivered with open clamping yokes. HC = High Current.

#### General ordering data

Type	BLZP 5.08HC/02/225B SN ...	Version	Product data	Packaging
Order No.	<a href="#">1945750000</a>	PCB plug-in connector, female plug, 5.08 mm, Number of poles: 2,	IEC: 400 V / 17.5 A / 0.2 - 4 mm <sup>2</sup>	Box
GTIN (EAN)	4032248621095	225°, Clamping yoke connection, Clamping range, max. : 4 mm <sup>2</sup> , Box	UL: 300 V / 15 A / AWG 26 - AWG 12	
Qty.	150 pc(s).			
Type	BLZP 5.08HC/02/225B SN ...	Version	Product data	Packaging
Order No.	<a href="#">1945980000</a>	PCB plug-in connector, female plug, 5.08 mm, Number of poles: 2,	IEC: 400 V / 17.5 A / 0.2 - 4 mm <sup>2</sup>	Box
GTIN (EAN)	4032248621507	225°, Clamping yoke connection, Clamping range, max. : 4 mm <sup>2</sup> , Box	UL: 300 V / 15 A / AWG 26 - AWG 12	
Qty.	150 pc(s).			

**OMNIMATE Signal - series BL/SL 5.08  
SL 5.08HC/02/180G 3.2SN OR BX**

**Weidmüller Interface GmbH & Co. KG**  
 Klingenbergstraße 26  
 D-32758 Detmold  
 Germany  
 Fon: +49 5231 14-0  
 Fax: +49 5231 14-292083  
 www.weidmueller.com

**Mating connector (fully pluggable)**
**BLL 5.08/180**

Female header for PCB mounting. The solder pin length is optimised for wave flow soldering.

**General ordering data**

Type	BLL 5.08/02/180 3.2 SN ...	Version	Product data	Packaging
Order No.	<a href="#">1630710000</a>	PCB plug-in connector, female header, closed side, THT solder	IEC: 400 V / 23 A	Box
GTIN (EAN)	4008190204136	connection, 5.08 mm, Number of poles: 2, 180°, Solder pin length (l):	UL: 300 V / 15 A	
Qty.	180 pc(s).	3.2 mm, tinned, orange, Box		

**BLL 5.08/90**

Female header for PCB mounting. The solder pin length is optimised for wave flow soldering.

**General ordering data**

Type	BLL 5.08/02/90 3.2 SN O ...	Version	Product data	Packaging
Order No.	<a href="#">1622940000</a>	PCB plug-in connector, female header, closed side, THT solder	IEC: 400 V / 23 A	Box
GTIN (EAN)	4008190194000	connection, 5.08 mm, Number of poles: 2, 90°, Solder pin length (l):	UL: 300 V / 15 A	
Qty.	180 pc(s).	3.2 mm, tinned, orange, Box		

**OMNIMATE Signal - series BL/SL 5.08  
SL 5.08HC/02/180G 3.2SN OR BX**

**Weidmüller Interface GmbH & Co. KG**  
Klingenbergstraße 26  
D-32758 Detmold  
Germany  
Fon: +49 5231 14-0  
Fax: +49 5231 14-292083  
www.weidmueller.com

**Mating connector (fully pluggable)**
**BLDT 5.08B**

Female plugs with two clamping-yoke screw connections per pole for wire connections with 90° and 270° outlet directions. The female plugs provide space for labelling and can be coded.

**General ordering data**

Type	BLDT 5.08/02/-B SN BK BX	Version	Product data	Packaging
Order No.	<a href="#">1673780000</a>	PCB plug-in connector, female plug, 5.08 mm, Number of poles: 2,	IEC: 400 V / 14 A / 0.2 - 2.5 mm <sup>2</sup>	Box
GTIN (EAN)	4008190435509	180°, Clamping yoke connection, Clamping range, max. : 3.31 mm <sup>2</sup> ,	UL: 300 V / 10 A / AWG 26 - AWG 12	
Qty.	130 pc(s).	Box		
Type	BLDT 5.08/02/-B SN OR BX	Version	Product data	Packaging
Order No.	<a href="#">1651740000</a>	PCB plug-in connector, female plug, 5.08 mm, Number of poles: 2,	IEC: 400 V / 14 A / 0.2 - 2.5 mm <sup>2</sup>	Box
GTIN (EAN)	4008190400422	180°, Clamping yoke connection, Clamping range, max. : 3.31 mm <sup>2</sup> ,	UL: 300 V / 10 A / AWG 26 - AWG 12	
Qty.	130 pc(s).	Box		

**BLDF 5.08/180 SN**



The powerful daisy-chain solution for high-performance signal bus applications is also suitable for 400V auxiliary power chains with 18.5A current-carrying capacity. The large clamping capacity (up to 2.5mm<sup>2</sup> wire cross-sections) is particularly beneficial for long bus cables or high currents because of the low voltage drop. Four flange variations, including the patented release latch, allow for user-friendly unplugging designs.

**General ordering data**

Type	BLDF 5.08/02/180 SN BK ...	Version	Product data	Packaging
Order No.	<a href="#">1000860000</a>	PCB plug-in connector, female plug, 5.08 mm, Number of poles: 2,	IEC: 400 V / 20.8 A / 0.2 - 2.5 mm <sup>2</sup>	Box
GTIN (EAN)	4032248817030	180°, PUSH IN, Spring connection, Clamping range, max. : 3.31 mm <sup>2</sup> ,	UL: 300 V / 18.5 A / AWG 12 - AWG	
Qty.	120 pc(s).	Box	26	
Type	BLDF 5.08/02/180 SN OR ...	Version	Product data	Packaging
Order No.	<a href="#">1001150000</a>	PCB plug-in connector, female plug, 5.08 mm, Number of poles: 2,	IEC: 400 V / 20.8 A / 0.2 - 2.5 mm <sup>2</sup>	Box
GTIN (EAN)	4032248818020	180°, PUSH IN, Spring connection, Clamping range, max. : 3.31 mm <sup>2</sup> ,	UL: 300 V / 18.5 A / AWG 12 - AWG	
Qty.	120 pc(s).	Box	26	

**OMNIMATE Signal - series BL/SL 5.08  
SL 5.08HC/02/180G 3.2SN OR BX**

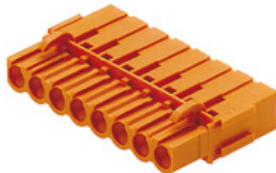
**Weidmüller Interface GmbH & Co. KG**  
Klingenbergstraße 26  
D-32758 Detmold  
Germany  
Fon: +49 5231 14-0  
Fax: +49 5231 14-292083  
www.weidmueller.com

**Mating connector (fully pluggable)**
**BLC 5.08BR**

Female plugs with crimp wire connection system. The female plugs provide space for labelling and can be coded.

**General ordering data**

Type	BLC 5.08/02/180BR OR BX	Version	Product data	Packaging
Order No.	<a href="#">1649370000</a>	PCB plug-in connector, female plug, 5.08 mm, Number of poles: 2,	IEC: 400 V / 21 A	Box
GTIN (EAN)	4008190294496	180°, Crimp connection, Clamping range, max. : 2.5 mm <sup>2</sup> , Box	UL: 300 V / 10 A / AWG 26 - AWG 14	
Qty.	100 pc(s).			
Type	BLC 5.08/02/180BR BK BX	Version	Product data	Packaging
Order No.	<a href="#">1712110000</a>	PCB plug-in connector, female plug, 5.08 mm, Number of poles: 2,	IEC: 400 V / 21 A	Box
GTIN (EAN)	4008190935122	180°, Crimp connection, Clamping range, max. : 2.5 mm <sup>2</sup> , Box	UL: 300 V / 10 A / AWG 26 - AWG 14	
Qty.	100 pc(s).			

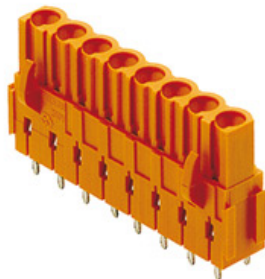
**BLL 5.08/180B**

Female header for PCB mounting. The solder pin length is optimised for wave flow soldering.

**General ordering data**

Type	BLL 5.08/02/180B 3.2SN ...	Version	Product data	Packaging
Order No.	<a href="#">1682730000</a>	PCB plug-in connector, female header, Dovetails for fixing blocks, THT	IEC: 400 V / 23 A	Box
GTIN (EAN)	4008190474492	solder connection, 5.08 mm, Number of poles: 2, 180°, Solder pin	UL: 300 V / 15 A	
Qty.	204 pc(s).	length (l): 3.2 mm, tinned, orange, Box		

## Recommended wave soldering profiles

**Weidmüller Interface GmbH & Co. KG**  
 Klängenbergstraße 16  
 D-32758 Detmold  
 Germany  
 Fon: +49 5231 14-0  
 Fax: +49 5231 14-292083  
 www.weidmueller.com

### Single Wave:



### Double Wave:



### Wave soldering profiles

Wired connection elements should be processed in accordance with the DIN EN 61760-1 standard. We have included two recommendations for practical wave soldering profiles, with which Weidmüller PCB terminals and connectors are qualified.

When choosing a suitable profile for your application, the following factors also need to be considered:

- PCB thickness
- Proportion of Cu in the layers
- Single/double-sided assembly
- Product range
- Heating and cooling rates

The single and double wave profiles each indicate the recommended operating range, including the maximum soldering temperature of 260°C. In practice, the maximum soldering temperature is quite often well below the above maximum profile.