

OMNIMATE Power - series BL/SL 7.62HP SLF 7.62HP/03/180F SN BK BX

Weidmüller Interface GmbH & Co. KG
Klingenbergstraße 26
D-32758 Detmold
Germany
Fon: +49 5231 14-0
Fax: +49 5231 14-292083
www.weidmueller.com

Product image

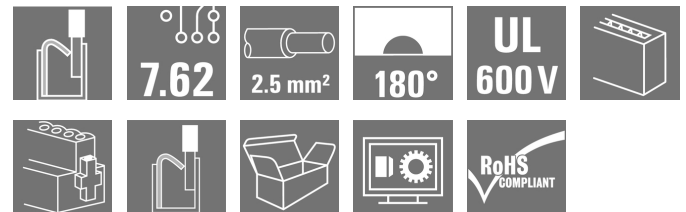

Similar to illustration

180° inverted male header with PUSH-IN connection technology for field wiring in 2.5 mm² with a 7.62 pitch. Also ideal as a touch-safe solution for inverse voltages. Meets the requirements of UL1059 600 V class C and IEC 61800-5-1.

Variants: available without flange, with external flange, with release latch.

General ordering data

Type	SLF 7.62HP/03/180F SN BK BX
Order No.	1043680000
Version	PCB plug-in connector, male plug, 7.62 mm, Number of poles: 3, 180°, PUSH IN, Clamping range, max. : 2.5 mm ² , Box
GTIN (EAN)	4032248775255
Qty.	54 pc(s).
Product data	IEC: 1000 V / 24 A / 0.5 - 2.5 mm ² UL: 600 V / 20 A / AWG 20 - AWG 12
Packaging	Box

Creation date May 1, 2020 10:38:40 AM CEST

**OMNIMATE Power - series BL/SL 7.62HP
SLF 7.62HP/03/180F SN BK BX**

Weidmüller Interface GmbH & Co. KG
 Klingenbergstraße 26
 D-32758 Detmold
 Germany
 Fon: +49 5231 14-0
 Fax: +49 5231 14-292083
 www.weidmueller.com

Technical data**Dimensions and weights**

Net weight	7.5 g
------------	-------

System Parameters

Product family	OMNIMATE Power - series BL/SL 7.62HP	Type of connection	Field connection
Wire connection method	PUSH IN	Pitch in mm (P)	7.62 mm
Pitch in inches (P)	0.3 inch	Conductor outlet direction	180°
Number of poles	3	L1 in mm	15.24 mm
L1 in inches	0.6 inch	Number of rows	1
Pin series quantity	1	Rated cross-section	2.5 mm ²
Touch-safe protection acc. to DIN VDE 57 106	Safe from finger touch	Touch-safe protection acc. to DIN VDE 0470	IP 20
Volume resistance	≤ 5mΩ	Can be coded	Yes
Stripping length	10 mm	Tightening torque for screw flange, min.	0.15 Nm
Tightening torque for screw flange, max.	0.25 Nm	Screwdriver blade	0.6 x 3.5
Screwdriver blade standard	DIN 5264-A		

Material data

Insulating material	PBT	Colour	black
Colour of operational elements	orange	Material of operational elements	PBT
Colour chart (similar)	RAL 9011	Insulating material group	IIIa
Comparative Tracking Index (CTI)	≥ 200	Insulation strength	≥ 10 ⁸ Ω
UL 94 flammability rating	V-0	GWFI	960 °C
Contact material	Copper alloy	Contact surface	tinned
Layer structure of plug contact	2-3 μm Ni / 2-4 μm Sn matt	Storage temperature, min.	-25 °C
Storage temperature, max.	50 °C	Max. relative humidity during storage	70 %
Operating temperature, min.	-50 °C	Operating temperature, max.	100 °C
Temperature range, installation, min.	-25 °C	Temperature range, installation, max.	100 °C

Conductors suitable for connection

Clamping range, min.	0.08 mm ²
Clamping range, max.	2.5 mm ²
Wire connection cross section AWG, min.	AWG 20
Wire connection cross section AWG, max.	AWG 14
Solid, min. H05(07) V-U	0.5 mm ²
Solid, max. H05(07) V-U	2.5 mm ²
Flexible, min. H05(07) V-K	0.5 mm ²
Flexible, max. H05(07) V-K	2.5 mm ²
w. plastic collar ferrule, DIN 46228 pt 4, 0.5 mm ² min.	
w. plastic collar ferrule, DIN 46228 pt 4, 1.5 mm ² max.	
w. wire end ferrule, DIN 46228 pt 1, 0.5 mm ² min.	
w. wire end ferrule, DIN 46228 pt 1, 1.5 mm ² max.	
Plug gauge in accordance with EN 60999 a x b; ø	2.8 mm x 2.0 mm

Creation date May 1, 2020 10:38:40 AM CEST

**OMNIMATE Power - series BL/SL 7.62HP
SLF 7.62HP/03/180F SN BK BX**

Weidmüller Interface GmbH & Co. KG
Klingenbergstraße 26
D-32758 Detmold
Germany
Fon: +49 5231 14-0
Fax: +49 5231 14-292083
www.weidmueller.com

Technical data

Clampable conductor	Cross-section for conductor connection	Type	fine-wired	
		nominal	0.5 mm ²	
	wire end ferrule	Stripping length	nominal	12 mm
		Recommended wire-end ferrule	H0.5/16 OR	
		Stripping length	nominal	10 mm
		Recommended wire-end ferrule	H0.5/10	
	Cross-section for conductor connection	Type	fine-wired	
		nominal	0.75 mm ²	
	wire end ferrule	Stripping length	nominal	12 mm
		Recommended wire-end ferrule	H0.75/16 W	
		Stripping length	nominal	10 mm
		Recommended wire-end ferrule	H0.75/10	
	Cross-section for conductor connection	Type	fine-wired	
		nominal	1 mm ²	
	wire end ferrule	Stripping length	nominal	12 mm
		Recommended wire-end ferrule	H1.0/16D R	
Stripping length		nominal	10 mm	
Recommended wire-end ferrule		H1.0/10		
Cross-section for conductor connection	Type	fine-wired		
	nominal	1.5 mm ²		
wire end ferrule	Stripping length	nominal	12 mm	
	Recommended wire-end ferrule	H1.5/16 R		
	Stripping length	nominal	10 mm	
	Recommended wire-end ferrule	H1.5/10		
Reference text	The outside diameter of the plastic collar should not be larger than the pitch (P). Length of ferrules is to be chosen depending on the product and the rated voltage.			
Max. clamping range	2.5 mm ²			

Rated data acc. to IEC

tested acc. to standard	IEC 60664-1, IEC 61984	Rated current, min. number of poles (Tu=20°C)	24 A
Rated current, max. number of poles (Tu=20°C)	24 A	Rated current, min. number of poles (Tu=40°C)	23.8 A
Rated current, max. number of poles (Tu=40°C)	21 A	Rated voltage for surge voltage class / pollution degree II/2	1,000 V
Rated voltage for surge voltage class / pollution degree III/2	1,000 V	Rated voltage for surge voltage class / pollution degree III/3	630 V
Rated impulse voltage for surge voltage class/ pollution degree II/2	6 kV	Rated impulse voltage for surge voltage class/ pollution degree III/2	8 kV
Rated impulse voltage for surge voltage class/ contamination degree III/3	6 kV	Short-time withstand current resistance	3 x 1s with 180 A
Clearance, min.	10.7 mm	Creepage distance, min.	10.7 mm

OMNIMATE Power - series BL/SL 7.62HP SLF 7.62HP/03/180F SN BK BX

Weidmüller Interface GmbH & Co. KG
Klingenbergstraße 26
D-32758 Detmold
Germany
Fon: +49 5231 14-0
Fax: +49 5231 14-292083
www.weidmueller.com

Technical data

Rated data acc. to CSA

Institute (CSA)



Certificate No. (CSA)

200039-1121690

Rated voltage (Use group B / CSA)	600 V
Rated voltage (Use group D / CSA)	600 V
Rated current (Use group C / CSA)	20 A
Wire cross-section, AWG, min.	AWG 20
Reference to approval values	Specifications are maximum values, details - see approval certificate.

Rated voltage (Use group C / CSA)	600 V
Rated current (Use group B / CSA)	20 A
Rated current (Use group D / CSA)	5 A
Wire cross-section, AWG, max.	AWG 12

Rated data acc. to UL 1059

Institute (cURus)



Certificate No. (cURus)

E60693

Rated voltage (Use group B / UL 1059)	600 V
Rated voltage (Use group D / UL 1059)	600 V
Rated current (Use group C / UL 1059)	20 A
Wire cross-section, AWG, min.	AWG 20
Reference to approval values	Specifications are maximum values, details - see approval certificate.

Rated voltage (Use group C / UL 1059)	600 V
Rated current (Use group B / UL 1059)	20 A
Rated current (Use group D / UL 1059)	5 A
Wire cross-section, AWG, max.	AWG 12

Packing

Packaging	Box	VPE length	0 m
VPE width	0 m	VPE height	0 m

Classifications

ETIM 6.0	EC002638	ETIM 7.0	EC002638
eClass 9.0	27-44-03-09	eClass 9.1	27-44-03-09
eClass 10.0	27-44-03-09	UNSPSC	30-21-18-01

OMNIMATE Power - series BL/SL 7.62HP SLF 7.62HP/03/180F SN BK BX

Weidmüller Interface GmbH & Co. KG
Klingenbergstraße 26
D-32758 Detmold
Germany
Fon: +49 5231 14-0
Fax: +49 5231 14-292083
www.weidmueller.com

Technical data

Notes

Notes	<ul style="list-style-type: none"> • Additional colours on request • Gold-plated contact surfaces on request • Rated current related to rated cross-section & min. No. of poles. • Wire end ferrule without plastic collar to DIN 46228/1 • Wire end ferrule with plastic collar to DIN 46228/4 • P on drawing = pitch • Rated data refer only to the component itself. Clearance and creepage distances to other components are to be designed in accordance with the relevant application standards.
-------	---

IPC conformity	Conformity: The products are developed, manufactured and delivered according international recognized standards and norms and comply with the assured properties in the data sheet resp. fulfill decorative properties in accordance with IPC-A-610 "Class 2". Further claims on the products can be evaluated on request.
----------------	--

Approvals

Approvals



ROHS	Conform
------	---------

Downloads

Approval/Certificate/Document of Conformity	Declaration of the Manufacturer
Brochure/Catalogue	FL DRIVES EN MB DEVICE MANUF. EN FL DRIVES DE CAT 2 PORTFOLIOGUIDE EN FL HEATING ELECTR EN FL APPL_INVERTER EN FL_BASE_STATION_EN FL ELEVATOR EN FL POWER SUPPLY EN FL 72H SAMPLE SER EN PO OMNIMATE EN
Engineering Data	EPLAN_WSCAD
Engineering Data	STEP
White paper power electronics connected correctly	Download Whitepaper
User Documentation	QR-Code product handling video
White paper UL 600 V	Download Whitepaper
White paper PUSH IN wire connection	Download Whitepaper

Data sheet

**OMNIMATE Power - series BL/SL 7.62HP
SLF 7.62HP/03/180F SN BK BX**

Weidmüller Interface GmbH & Co. KG
Klingenbergstraße 26
D-32758 Detmold
Germany
Fon: +49 5231 14-0
Fax: +49 5231 14-292083
www.weidmueller.com

Drawings

Dimensional drawing

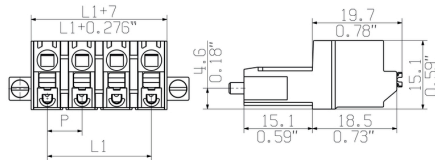

Graph

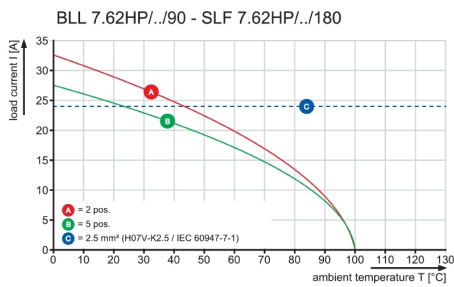

Graph

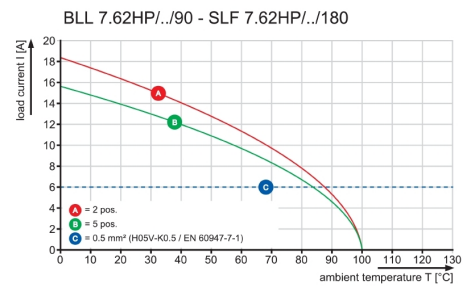

**OMNIMATE Power - series BL/SL 7.62HP
SLF 7.62HP/03/180F SN BK BX**

Weidmüller Interface GmbH & Co. KG
Klingenbergstraße 26
D-32758 Detmold
Germany
Fon: +49 5231 14-0
Fax: +49 5231 14-292083
www.weidmueller.com

Mating connector (fully pluggable)
BLL 7.62HP/180F

180° female header for the PCB with a pitch of 7.62. Meets IEC 61800-5-1 requirements and enables UL approval as per UL840 600 V. Ideal touch-safe solution for the power output and intermediate circuit applications. The mating profile guarantees touch safety of >3 mm as per IEC61800-5-1. Variants: without flange, with screw flange or with soldered flange.

General ordering data

Type	BLL 7.62HP/03/180F 3.2S ...	Version	Product data	Packaging
Order No.	1122120000	PCB plug-in connector, female header, Flange, THT solder connection,	IEC: 630 V / 24 A	Box
GTIN (EAN)	4032248903269	7.62 mm, Number of poles: 3, 180°, Solder pin length (l): 3.2 mm,	UL: 300 V / 20 A	
Qty.	54 pc(s).	tinned, black, Box		
Type	BLL 7.62HP/03/180F 3.2S ...	Version	Product data	Packaging
Order No.	1122170000	PCB plug-in connector, female header, Flange, THT solder connection,	IEC: 630 V / 24 A	Box
GTIN (EAN)	4032248903276	7.62 mm, Number of poles: 3, 180°, Solder pin length (l): 3.2 mm,	UL: 300 V / 20 A	
Qty.	54 pc(s).	tinned, orange, Box		

BLL 7.62HP/90LF

90° female header for the PCB with a pitch of 7.62. Meets IEC 61800-5-1 requirements and enables UL approval as per UL840 600 V. Ideal touch-safe solution for the power output and intermediate circuit applications. The mating profile guarantees touch safety of >3 mm as per IEC61800-5-1. Variants: without flange, flange version, soldered flange version.

General ordering data

Type	BLL 7.62HP/03/90LF 3.2S ...	Version	Product data	Packaging
Order No.	1095650000	PCB plug-in connector, female header, Solder flange, THT solder	IEC: 630 V / 24 A	Box
GTIN (EAN)	4032248868544	connection, 7.62 mm, Number of poles: 3, 90°, Solder pin length (l):	UL: 300 V / 20 A	
Qty.	54 pc(s).	3.2 mm, tinned, black, Box		
Type	BLL 7.62HP/03/90LF SN O ...	Version	Product data	Packaging
Order No.	1095610000	PCB plug-in connector, female header, Solder flange, THT solder	IEC: 630 V / 24 A	Box
GTIN (EAN)	4032248868353	connection, 7.62 mm, Number of poles: 3, 90°, Solder pin length (l):	UL: 300 V / 20 A	
Qty.	54 pc(s).	3.2 mm, tinned, orange, Box		

**OMNIMATE Power - series BL/SL 7.62HP
SLF 7.62HP/03/180F SN BK BX**

Weidmüller Interface GmbH & Co. KG
Klingenbergstraße 26
D-32758 Detmold
Germany
Fon: +49 5231 14-0
Fax: +49 5231 14-292083
www.weidmuller.com

Mating connector (fully pluggable)**BLL 7.62HP/180LF**

180° female header for the PCB with a pitch of 7.62. Meets IEC 61800-5-1 requirements and enables UL approval as per UL840 600 V. Ideal touch-safe solution for the power output and intermediate circuit applications. The mating profile guarantees touch safety of >3 mm as per IEC61800-5-1. Variants: without flange, with screw flange or with soldered flange.

General ordering data

Type	BLL 7.62HP/03/180LF SN ...	Version	Product data	Packaging
Order No.	1134050000	PCB plug-in connector, female header, Solder flange, THT solder connection, 7.62 mm, Number of poles: 3, 180°, Solder pin length (l): 3.2 mm, tinned, orange, Box	IEC: 630 V / 24 A UL: 300 V / 20 A	Box
GTIN (EAN)	4032248914050			
Qty.	54 pc(s).			
Type	BLL 7.62HP/03/180LF 3.2 ...	Version	Product data	Packaging
Order No.	1134090000	PCB plug-in connector, female header, Solder flange, THT solder connection, 7.62 mm, Number of poles: 3, 180°, Solder pin length (l): 3.2 mm, tinned, black, Box	IEC: 630 V / 24 A UL: 300 V / 20 A	Box
GTIN (EAN)	4032248914074			
Qty.	54 pc(s).			

BLL 7.62HP/90F

90° female header for the PCB with a pitch of 7.62. Meets IEC 61800-5-1 requirements and enables UL approval as per UL840 600 V. Ideal touch-safe solution for the power output and intermediate circuit applications. The mating profile guarantees touch safety of >3 mm as per IEC61800-5-1. Variants: without flange, flange version, soldered flange version.

General ordering data

Type	BLL 7.62HP/03/90F 3.2SN ...	Version	Product data	Packaging
Order No.	1043320000	PCB plug-in connector, female header, Flange, THT solder connection, 7.62 mm, Number of poles: 3, 90°, Solder pin length (l): 3.2 mm, tinned, orange, Box	IEC: 630 V / 24 A UL: 300 V / 20 A	Box
GTIN (EAN)	4032248774890			
Qty.	54 pc(s).			
Type	BLL 7.62HP/03/90F 3.2SN ...	Version	Product data	Packaging
Order No.	1043280000	PCB plug-in connector, female header, Flange, THT solder connection, 7.62 mm, Number of poles: 3, 90°, Solder pin length (l): 3.2 mm, tinned, black, Box	IEC: 630 V / 24 A UL: 300 V / 20 A	Box
GTIN (EAN)	4032248774852			
Qty.	54 pc(s).			

OMNIMATE Power - series BL/SL 7.62HP SLF 7.62HP/03/180F SN BK BX

Weidmüller Interface GmbH & Co. KG
 Klingenbergstraße 26
 D-32758 Detmold
 Germany
 Fon: +49 5231 14-0
 Fax: +49 5231 14-292083
 www.weidmueller.com

Accessories

PZ



Crimping tools for wire end ferrules, with and without plastic collars

- Ratchet guarantees precise crimping
- Release option in the event of incorrect operation

General ordering data

Type	PZ 6/5	Version	
Order No.	9011460000	Pressing tool, Crimping tool for wire-end ferrules, 0.25mm ² , 6mm ² ,	
GTIN (EAN)	4008190165352	Trapezoidal indentation crimp	
Qty.	1 pc(s).		

Coding elements



Only connects what is supposed to be connected: the right connection at the right place.

Coding elements and locking devices clearly assign connecting elements during the manufacturing process and operation

The coding elements and locking devices are inserted prior to assembly or during the cable assembly phase.

The Weidmüller alternative: configure online using the variant configurator to precode prior to delivery.

Incorrect assembly on the circuit board and incorrect plugging of connecting elements is no longer possible.

The advantage: no troubleshooting during manufacture and no operational errors by the user.

General ordering data

Type	BLZ/SL KO BK BX	Version	Product data	Packaging
Order No.	1545710000	PCB plug-in connector, Accessories, Coding element, black, Number		Box
GTIN (EAN)	4008190087142	of poles: 1		
Qty.	50 pc(s).			
Type	BLZ/SL KO OR BX	Version	Product data	Packaging
Order No.	1573010000	PCB plug-in connector, Accessories, Coding element, orange, Number		Box
GTIN (EAN)	4008190048396	of poles: 1		
Qty.	100 pc(s).			

**OMNIMATE Power - series BL/SL 7.62HP
SLF 7.62HP/03/180F SN BK BX**

Weidmüller Interface GmbH & Co. KG
Klingenbergstraße 26
D-32758 Detmold
Germany
Fon: +49 5231 14-0
Fax: +49 5231 14-292083
www.weidmueller.com

Accessories

Slotted screwdriver

Slotted screwdriver with rounded blade SD DIN 5265, ISO 2380/2, output to DIN 5264, ISO 2380/1. ChromTop tip, SoftFinish grip



General ordering data

Type	SDS 0.6X3.5X100	Version
Order No.	9008330000	Screwdriver, Blade width (B): 3.5 mm, Blade length: 100 mm, Blade thickness (A): 0.6 mm
GTIN (EAN)	4032248056286	
Qty.	1 pc(s).	

Slotted screwdriver

VDE insulated slot-head screwdriver, SDI DIN 7437, ISO 2380/2, drive output acc. to DIN 5264, ISO 2380/1. SoftFinish grip



General ordering data

Type	SDIS 0.6X3.5X100	Version
Order No.	9008390000	Screwdriver, Blade width (B): 3.5 mm, Blade length: 100 mm, Blade thickness (A): 0.6 mm
GTIN (EAN)	4032248056354	
Qty.	1 pc(s).	

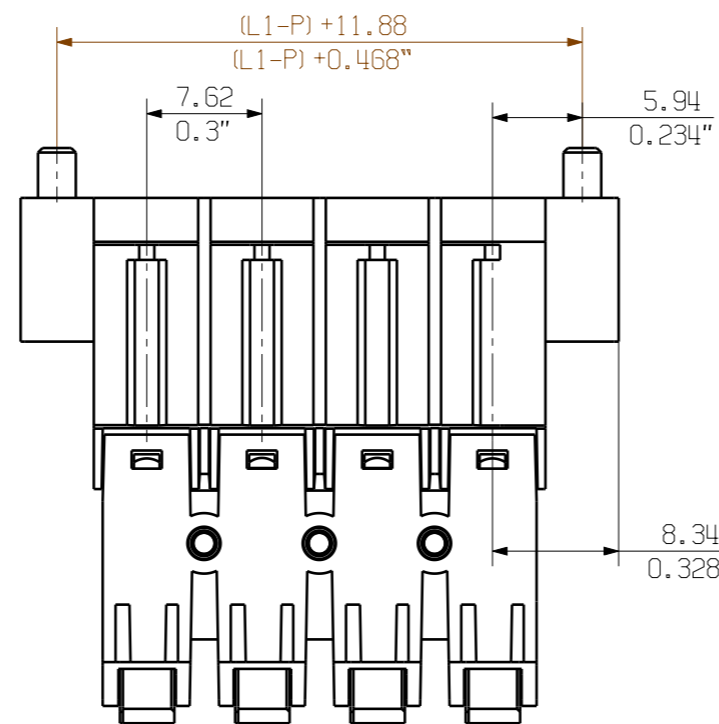
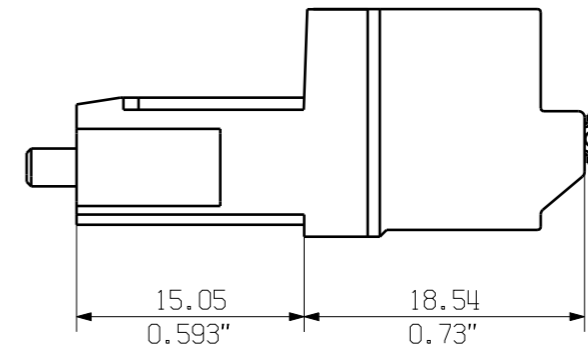
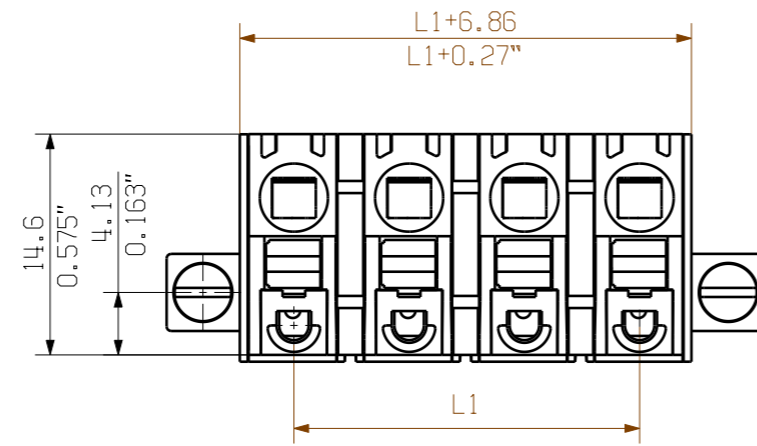

M 1/1

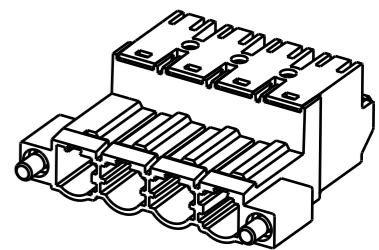

12	83,82	3,30
11	76,20	3,00
10	68,58	2,70
9	60,96	2,40
8	53,34	2,10
7	45,72	1,80
6	38,10	1,50
5	30,48	1,20
4	22,86	0,90
3	15,24	0,60
2	7,62	0,30
n	L1 (mm)	L1 (inch)

DARGESTELLT / SHOWN : SLF7.62HP/04/180F

GENERAL TOLERANCE: DIN ISO 2768-mK 	94118/5 23.04.18 HELIS_MA 00			Cat.no.: .	
	Modification			3 46068	
	Drawn	12.04.2018	HELIS_MA	Drawing no. 3 46068 Issue no. 03 Sheet 02 of 04 sheets	
	Responsible		DOMRATH_M	SLF 7.62HP/.../180 STIFTLISTE PIN HEADER	
	Checked	24.04.2018	HELIS_MA		
Supersedes: .	Approved		NOLTE_S	Product file: BLF/SLF7.62HP	7381

The reproduction, distribution and utilization of this document as well as the communication of its contents to others without explicit authorization is prohibited. Offenders will be held liable for the payment of damages. Weidmüller exclusively reserves the right to file for patents, utility models or designs.

© Weidmüller Interface GmbH & Co. KG