

OMNIMATE Signal - series BC/SC 3.81 SCD 3.81/08/180F 3.2SN OR BX

Weidmüller Interface GmbH & Co. KG
Klingenbergstraße 26
D-32758 Detmold
Germany
Fon: +49 5231 14-0
Fax: +49 5231 14-292083
www.weidmueller.com

Product image

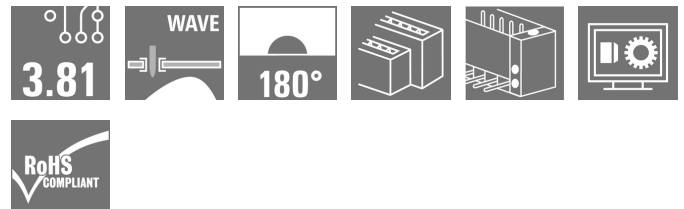

Similar to illustration

Two-tier SCD pin header for wave soldering.

- It allows you to use two interfaces on only one surface and with only one step in the work flow.
- Outlet direction: 180° (standing).
- Connections at the same level and with access that is flush over the front board.
- Space for labelling and coding
- Packed in cardboard box.

Weidmüller's 3.81-mm-pitch (0.15 inch) plug-in connectors are compatible with the layouts of standard connectors and offer space for labelling and coding.

General ordering data

| | |
|--------------|--|
| Type | SCD 3.81/08/180F 3.2SN OR BX |
| Order No. | 1030460000 |
| Version | PCB plug-in connector, male header, Flange, THT solder connection, 3.81 mm, Number of poles: 8, 180°, Solder pin length (l): 3.2 mm, tinned, orange, Box |
| GTIN (EAN) | 4032248759606 |
| Qty. | 50 pc(s). |
| Product data | IEC: 320 V / 17.5 A UL: 300 V / 10 A |
| Packaging | Box |

Creation date May 1, 2020 8:24:17 AM CEST

**OMNIMATE Signal - series BC/SC 3.81
SCD 3.81/08/180F 3.2SN OR BX**

Weidmüller Interface GmbH & Co. KG
 Klingenbergstraße 26
 D-32758 Detmold
 Germany
 Fon: +49 5231 14-0
 Fax: +49 5231 14-292083
 www.weidmueller.com

Technical data**Dimensions and weights**

| | | | |
|--------------------------|------------|-----------------|------------|
| Width | 25.63 mm | Width (inches) | 1.009 inch |
| Height | 25.1 mm | Height (inches) | 0.988 inch |
| Height of lowest version | 21.9 mm | Depth | 22.7 mm |
| Depth (inches) | 0.894 inch | Net weight | 9.74 g |

Environmental Product Compliance

| | |
|------------|----------------|
| REACH SVHC | Lead 7439-92-1 |
|------------|----------------|

System specifications

| | | | |
|--|-------------------------------------|-------------------|--|
| Product family | OMNIMATE Signal - series BC/SC 3.81 | | |
| Type of connection | Board connection | | |
| Mounting onto the PCB | THT solder connection | | |
| Pitch in mm (P) | 3.81 mm | | |
| Pitch in inches (P) | 0.15 inch | | |
| Outgoing elbow | 180° | | |
| Number of poles | 8 | | |
| Number of solder pins per pole | 1 | | |
| Solder pin length (l) | 3.2 mm | | |
| Solder pin length tolerance | +0,02 / -0,02 mm | | |
| Tolerance of solder pin position | ± 0.1 mm | | |
| Solder pin dimensions | d = 1.0 mm, Octagonal | | |
| Solder pin dimensions = d tolerance | 0 / -0,03 mm | | |
| Solder eyelet hole diameter (D) | 1.2 mm | | |
| Solder eyelet hole diameter tolerance (D) | + 0,1 mm | | |
| L1 in mm | 11.43 mm | | |
| L1 in inches | 0.45 inch | | |
| Number of rows | 2 | | |
| Pin series quantity | 2 | | |
| Touch-safe protection acc. to DIN VDE 57 106 | Safe from finger touch | | |
| Touch-safe protection acc. to DIN VDE 0470 | IP 20 | | |
| Volume resistance | ≤ 5mΩ | | |
| Can be coded | Yes | | |
| Plugging cycles | 25 | | |
| Plugging force/pole, max. | 8 N | | |
| Pulling force/pole, max. | 5.5 N | | |
| Tightening torque | Torque type | PCB, Screw flange | |
| | Usage information | Tightening torque | min. 0.15 Nm max. 0.2 Nm |
| | | Recommended screw | Part number PTSC KA 2.2X4.5 WN1412 |

**OMNIMATE Signal - series BC/SC 3.81
SCD 3.81/08/180F 3.2SN OR BX**

Weidmüller Interface GmbH & Co. KG
 Klingenbergstraße 26
 D-32758 Detmold
 Germany
 Fon: +49 5231 14-0
 Fax: +49 5231 14-292083
 www.weidmueller.com

Technical data**Material data**

| | | | |
|---------------------------------------|--------------|---------------------------------------|---------------------|
| Insulating material | PA GF | Colour | orange |
| Colour chart (similar) | RAL 2000 | Insulating material group | II |
| Comparative Tracking Index (CTI) | ≥ 550 | Insulation strength | ≥ 10 ⁸ Ω |
| UL 94 flammability rating | V-0 | GWFI | 960 °C |
| Contact material | Copper alloy | Contact surface | tinned |
| Storage temperature, min. | -25 °C | Storage temperature, max. | 50 °C |
| Max. relative humidity during storage | 70 % | Operating temperature, min. | -50 °C |
| Operating temperature, max. | 120 °C | Temperature range, installation, min. | -25 °C |
| Temperature range, installation, max. | 120 °C | | |

Rated data acc. to IEC

| | | | |
|---|------------------------|---|------------------|
| tested acc. to standard | IEC 60664-1, IEC 61984 | Rated current, min. number of poles (Tu=20°C) | 17.5 A |
| Rated current, min. number of poles (Tu=40°C) | 17 A | Rated voltage for surge voltage class / pollution degree II/2 | 320 V |
| Rated voltage for surge voltage class / pollution degree III/2 | 160 V | Rated voltage for surge voltage class / pollution degree III/3 | 160 V |
| Rated impulse voltage for surge voltage class/ pollution degree II/2 | 2.5 kV | Rated impulse voltage for surge voltage class/ pollution degree III/2 | 2.5 kV |
| Rated impulse voltage for surge voltage class/ contamination degree III/3 | 2.5 kV | Short-time withstand current resistance | 3 x 1s with 76 A |

Rated data acc. to CSA

| | | | |
|-----------------------------------|-------|-----------------------------------|------|
| Rated voltage (Use group B / CSA) | 300 V | Rated current (Use group B / CSA) | 11 A |
|-----------------------------------|-------|-----------------------------------|------|

Rated data acc. to UL 1059

| | | | |
|---------------------------------------|---|---------------------------------------|--------|
| Institute (cURus) |  | Certificate No. (cURus) | E60693 |
| Rated voltage (Use group B / UL 1059) | 300 V | Rated voltage (Use group D / UL 1059) | 300 V |
| Rated current (Use group B / UL 1059) | 10 A | Rated current (Use group D / UL 1059) | 10 A |
| Reference to approval values | Specifications are maximum values, details - see approval certificate. | | |

Packing

| | | | |
|-----------|--------|------------|--------|
| Packaging | Box | VPE length | 25 mm |
| VPE width | 140 mm | VPE height | 255 mm |

Classifications

| | | | |
|-------------|-------------|------------|-------------|
| ETIM 6.0 | EC002637 | ETIM 7.0 | EC002637 |
| eClass 9.0 | 27-44-04-02 | eClass 9.1 | 27-44-04-02 |
| eClass 10.0 | 27-44-04-02 | | |

**OMNIMATE Signal - series BC/SC 3.81
SCD 3.81/08/180F 3.2SN OR BX**

Weidmüller Interface GmbH & Co. KG
 Klingenbergstraße 26
 D-32758 Detmold
 Germany
 Fon: +49 5231 14-0
 Fax: +49 5231 14-292083
 www.weidmueller.com

Technical data**Notes**

| | |
|----------------|--|
| Notes | <ul style="list-style-type: none"> • Additional colours on request • Rated current related to rated cross-section & min. No. of poles. • Rated data refer only to the component itself. Clearance and creepage distances to other components are to be designed in accordance with the relevant application standards. • P on drawing = pitch • Rated data refer only to the component itself. Clearance and creepage distances to other components are to be designed in accordance with the relevant application standards. • For additional mechanical support for male connectors with screw flange (...F), we recommend an additional cable gland with fastening screws (sheet metal screw ISO 148 1-ST 2.2x4.5 C or ISO 7049-ST 2.2x4.5 C – see Accessories). Cable gland only permitted before soldering. |
| IPC conformity | Conformity: The products are developed, manufactured and delivered according international recognized standards and norms and comply with the assured properties in the data sheet resp. fulfill decorative properties in accordance with IPC-A-610 "Class 2". Further claims on the products can be evaluated on request. |

Approvals

Approvals



ROHS

Conform

Downloads

| | |
|---|--|
| Approval/Certificate/Document of Conformity | Declaration of the Manufacturer |
| Brochure/Catalogue | FL DRIVES EN MB DEVICE MANUF. EN FL DRIVES DE CAT 2 PORTFOLIOGUIDE EN FL BUILDING SAFETY EN FL APPL LED LIGHTING EN FLIndustr.CONTROLS EN FL MACHINE SAFETY EN FL HEATING ELECTR EN FL APPL INVERTER EN FL_BASE_STATION_EN FL ELEVATOR EN FL POWER SUPPLY EN FL 72H SAMPLE SER EN PO OMNIMATE EN |
| Engineering Data | EPLAN, WSCAD |
| Engineering Data | STEP |
| Product Change Notification | Change of packaging - DE Change of packaging - EN |

**OMNIMATE Signal - series BC/SC 3.81
SCD 3.81/08/180F 3.2SN OR BX**

Weidmüller Interface GmbH & Co. KG
 Klingenbergstraße 26
 D-32758 Detmold
 Germany
 Fon: +49 5231 14-0
 Fax: +49 5231 14-292083
 www.weidmueller.com

Drawings

Dimensional drawing

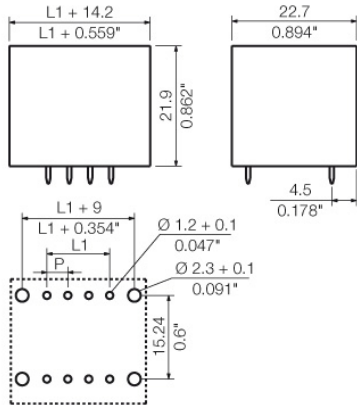

OMNIMATE Signal - series BC/SC 3.81 SCD 3.81/08/180F 3.2SN OR BX

Weidmüller Interface GmbH & Co. KG
 Klingenbergstraße 26
 D-32758 Detmold
 Germany
 Fon: +49 5231 14-0
 Fax: +49 5231 14-292083
 www.weidmueller.com

Accessories

Coding elements



Only connects what is supposed to be connected: the right connection at the right place.

Coding elements and locking devices clearly assign connecting elements during the manufacturing process and operation

The coding elements and locking devices are inserted prior to assembly or during the cable assembly phase. The Weidmüller alternative: configure online using the variant configurator to precode prior to delivery.

Incorrect assembly on the circuit board and incorrect plugging of connecting elements is no longer possible. The advantage: no troubleshooting during manufacture and no operational errors by the user.

General ordering data

| Type | SC-SMT 3.81 KO GY BX | Version | Product data | Packaging |
|------------|----------------------------|---|--------------|-----------|
| Order No. | 1968900000 | PCB plug-in connector, Accessories, Coding element, grey, Number of | | Box |
| GTIN (EAN) | 4032248772865 | poles: 6 | | |
| Qty. | 100 pc(s). | | | |

Additional accessories



No task is too small when creating the perfect solution. br />

Connections form just one part of the overall process. Small details are often the key to the perfect solution in applications where potentials are tested, grouped or even isolated.

A system is not a system without small but useful details:

- Test plugs - ensure reliable pick-up from diagnostic sockets
- Cross-connectors - ensure a stable electrical distribution contact directly at the connection
- Compartment partition elements - divide a large number of male connectors into several separate socket connector channels
- Locks and clips - optional vibration-resistant clip-on connection or mounting for male and female connectors

In tandem with the manufacturing process and application - more accessories = smaller workload

General ordering data

| Type | PTSC KA 2.2X4.5 WN1412 | Version | Product data |
|------------|----------------------------|---|--------------|
| Order No. | 1610740000 | PCB plug-in connector, Accessories, Mounting screw, Number of | |
| GTIN (EAN) | 4008190039523 | poles: 1 | |
| Qty. | 100 pc(s). | | |

04

SCD 3.81/.../180G 3.2...

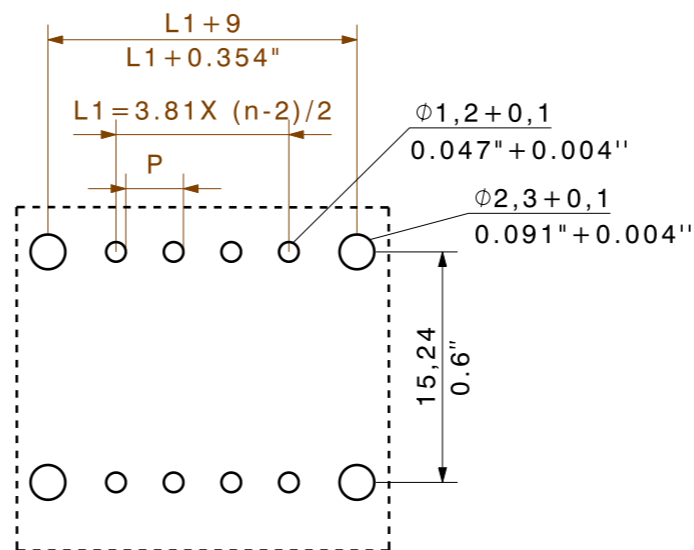
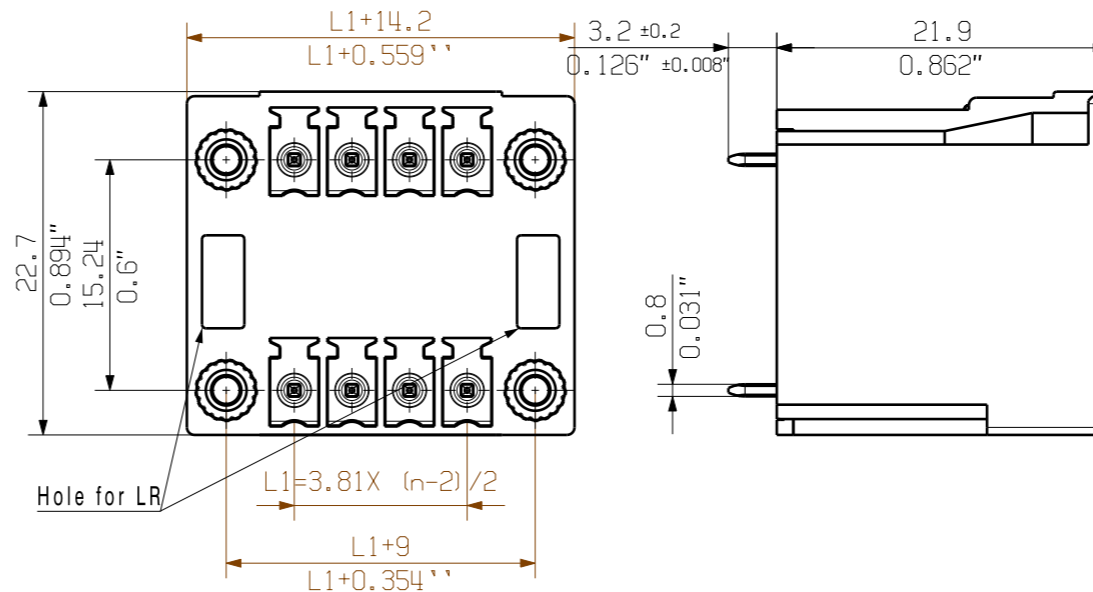
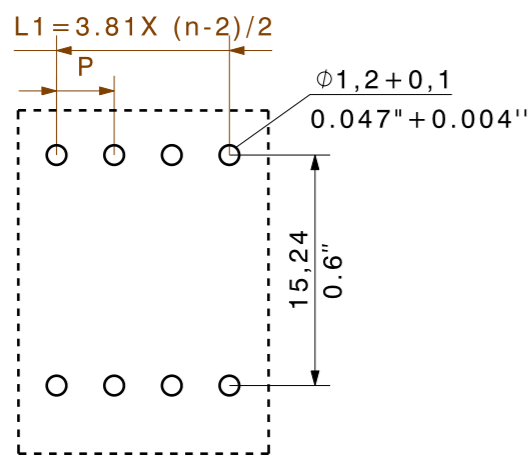
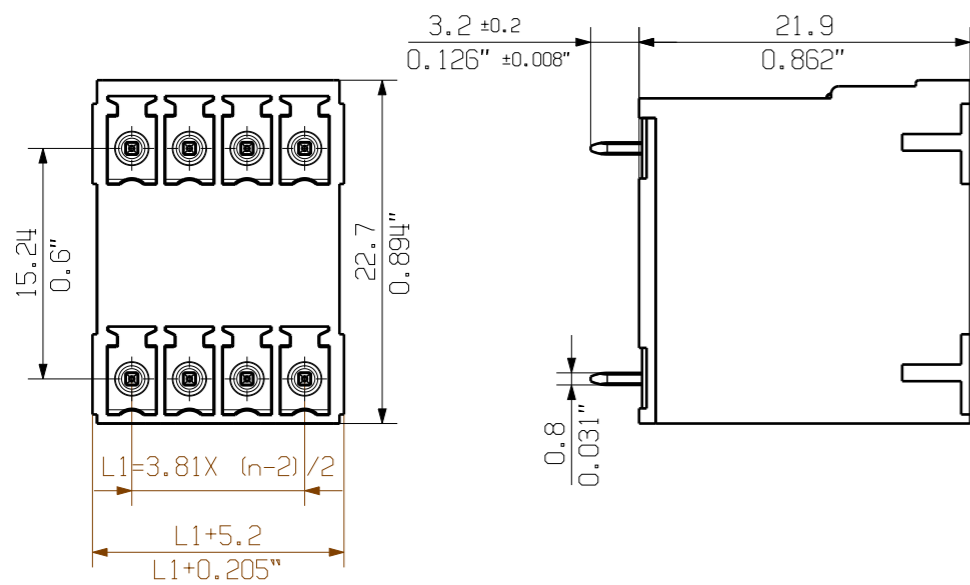

SCD 3.81/.../180F 3.2...
WITH
BCF 3.81/.../180 LR

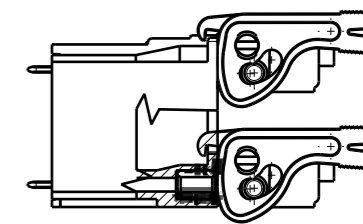

SCD 3.81/.../180F 3.2...
WITH
BCF 3.81/.../180 LR
M 1/1

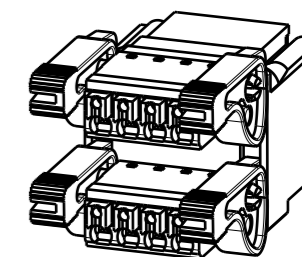

NOTE:

n=NO OF POLES
P=PITCH

KUNDENZEICHUNG
CUSTOMER DRAWING

For the mounting of PCBs, it should be noted that the rated data stated here relates only to the PCB components alone.

The necessary creepage and clearance paths must be observed in connection with the respective applicant in accordance to IEC 664 / VDE 0110.

The current-carrying capacity and pitch tolerance is to be determined according to DIN IEC 326 part 3 very fine.

Weidmüller PCB components are tested to the DIN EN 61984 standard, and are valid for its field of application. Provided that the components are used to the intended purpose, all requirements with respect to the occurring of electrical, mechanical, thermic and corrosive stress will be satisfied.

| | | |
|----|---------|-----------|
| 16 | 57.15 | 2.250 |
| 15 | 53.34 | 2.100 |
| 14 | 49.53 | 1.950 |
| 13 | 45.72 | 1.800 |
| 12 | 41.91 | 1.650 |
| 11 | 38.10 | 1.500 |
| 10 | 34.29 | 1.350 |
| 9 | 30.48 | 1.200 |
| 8 | 26.67 | 1.050 |
| 7 | 22.86 | 0.900 |
| 6 | 19.05 | 0.750 |
| 5 | 15.24 | 0.600 |
| 4 | 11.43 | 0.450 |
| 3 | 7.62 | 0.300 |
| 2 | 3.81 | 0.150 |
| n | L1 [mm] | L1 [inch] |

| | | | | | |
|--------------------------------------|--|-----------------------------|--|----------------------------------|--|
| GENERAL TOLERANCE: DIN ISO 2768-m | | 99958/4 06.03.18 MA_J 01 | | Cat.no.: | |
| RoHS COMPLIANT Max. nos. | | Modification | | C 46286 04 | |
| Scale: 5/1 | | Date | | Drawing no. Issue no. | |
| Supersedes: . | | Name | | Sheet 01 of 02 sheets | |
| Drawn | | 08.01.2009 | | GE_G | |
| Responsible | | MA_J | | SCD... 3.81/.../180... | |
| Checked | | 14.03.2018 | | THR-LOETANSCHLUSS STIFTLISTE | |
| Approved | | XU_S | | THR SOLDER CONNECTION PIN HEADER | |
| Product file: SCD 3.81 | | 7079 | | | |

The reproduction, distribution and utilization of this document as well as the communication of its contents to others without explicit authorization is prohibited. Offenders will be held liable for the payment of damages. Weidmüller exclusively reserves the right to file for patents, utility models or designs.

© Weidmüller Interface GmbH & Co. KG

Recommended wave soldering profiles

Weidmüller Interface GmbH & Co. KG
 Klingenbergstraße 16
 D-32758 Detmold
 Germany
 Fon: +49 5231 14-0
 Fax: +49 5231 14-292083
 www.weidmueller.com

Single Wave:



Double Wave:



Wave soldering profiles

Wired connection elements should be processed in accordance with the DIN EN 61760-1 standard. We have included two recommendations for practical wave soldering profiles, with which Weidmüller PCB terminals and connectors are qualified.

When choosing a suitable profile for your application, the following factors also need to be considered:

- PCB thickness
- Proportion of Cu in the layers
- Single/double-sided assembly
- Product range
- Heating and cooling rates

The single and double wave profiles each indicate the recommended operating range, including the maximum soldering temperature of 260°C. In practice, the maximum soldering temperature is quite often well below the above maximum profile.