

OMNIMATE Signal - series BC/SC 3.81 SCD 3.81/22/180G 3.2SN OR BX

Weidmüller Interface GmbH & Co. KG
Klingenbergstraße 26
D-32758 Detmold
Germany
Fon: +49 5231 14-0
Fax: +49 5231 14-292083
www.weidmueller.com

Product image

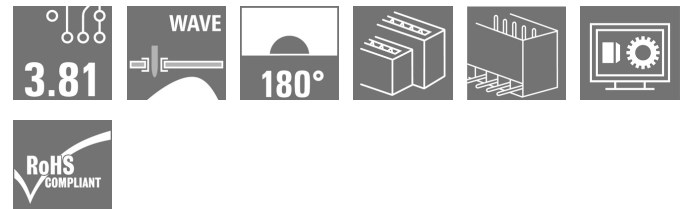

Similar to illustration

Two-tier SCD pin header for wave soldering.

- It allows you to use two interfaces on only one surface and with only one step in the work flow.
- Outlet direction: 180° (standing).
- Connections at the same level and with access that is flush over the front board.
- Space for labelling and coding
- Packed in cardboard box.

Weidmüller's 3.81-mm-pitch (0.15 inch) plug-in connectors are compatible with the layouts of standard connectors and offer space for labelling and coding.

General ordering data

Type	SCD 3.81/22/180G 3.2SN OR BX
Order No.	1030030000
Version	PCB plug-in connector, male header, closed side, THT solder connection, 3.81 mm, Number of poles: 22, 180°, Solder pin length (l): 3.2 mm, tinned, orange, Box
GTIN (EAN)	4032248759149
Qty.	50 pc(s).
Product data	IEC: 320 V / 17.5 A UL: 300 V / 10 A
Packaging	Box

Creation date May 1, 2020 8:18:48 AM CEST

**OMNIMATE Signal - series BC/SC 3.81
SCD 3.81/22/180G 3.2SN OR BX**

Weidmüller Interface GmbH & Co. KG
Klingenbergstraße 26
D-32758 Detmold
Germany
Fon: +49 5231 14-0
Fax: +49 5231 14-292083
www.weidmueller.com

Technical data**Dimensions and weights**

Width	43.3 mm	Width (inches)	1.705 inch
Height	25.1 mm	Height (inches)	0.988 inch
Height of lowest version	21.9 mm	Depth	22.7 mm
Depth (inches)	0.894 inch	Net weight	15.908 g

System specifications

Product family	OMNIMATE Signal - series BC/SC 3.81	Type of connection	Board connection
Mounting onto the PCB	THT solder connection	Pitch in mm (P)	3.81 mm
Pitch in inches (P)	0.15 inch	Outgoing elbow	180°
Number of poles	22	Number of solder pins per pole	1
Solder pin length (l)	3.2 mm	Solder pin length tolerance	+0,02 / -0,02 mm
Tolerance of solder pin position	± 0.15 mm	Solder pin dimensions	d = 1.0 mm, Octagonal
Solder pin dimensions = d tolerance	0 / -0,03 mm	Solder eyelet hole diameter (D)	1.2 mm
Solder eyelet hole diameter tolerance (D)+	0,1 mm	L1 in mm	38.1 mm
L1 in inches	1.5 inch	Number of rows	2
Pin series quantity	2	Touch-safe protection acc. to DIN VDE 57 106	Safe from finger touch
Touch-safe protection acc. to DIN VDE 0470	IP 20	Volume resistance	≤ 5mΩ
Can be coded	Yes	Plugging cycles	25
Plugging force/pole, max.	8 N	Pulling force/pole, max.	5.5 N

Material data

Insulating material	PA GF	Colour	orange
Colour chart (similar)	RAL 2000	Insulating material group	II
Comparative Tracking Index (CTI)	≥ 550	Insulation strength	≥ 10 ⁸ Ω
UL 94 flammability rating	V-0	GWFI	960 °C
Contact material	Copper alloy	Contact surface	tinned
Storage temperature, min.	-25 °C	Storage temperature, max.	50 °C
Max. relative humidity during storage	70 %	Operating temperature, min.	-50 °C
Operating temperature, max.	120 °C	Temperature range, installation, min.	-25 °C
Temperature range, installation, max.	120 °C		

Rated data acc. to IEC

tested acc. to standard	IEC 60664-1, IEC 61984	Rated current, min. number of poles (Tu=20°C)	17.5 A
Rated current, min. number of poles (Tu=40°C)	17 A	Rated voltage for surge voltage class / pollution degree II/2	320 V
Rated voltage for surge voltage class / pollution degree III/2	160 V	Rated voltage for surge voltage class / pollution degree III/3	160 V
Rated impulse voltage for surge voltage class/ pollution degree II/2	2.5 kV	Rated impulse voltage for surge voltage class/ pollution degree III/2	2.5 kV
Rated impulse voltage for surge voltage class/ contamination degree III/3	2.5 kV	Short-time withstand current resistance	3 x 1s with 76 A

Rated data acc. to CSA

Rated voltage (Use group B / CSA)	300 V	Rated current (Use group B / CSA)	11 A
-----------------------------------	-------	-----------------------------------	------

Data sheet

**OMNIMATE Signal - series BC/SC 3.81
SCD 3.81/22/180G 3.2SN OR BX**

Weidmüller Interface GmbH & Co. KG
Klingenbergstraße 26
D-32758 Detmold
Germany
Fon: +49 5231 14-0
Fax: +49 5231 14-292083
www.weidmueller.com

Technical data

Rated data acc. to UL 1059

Institute (cURus)



Certificate No. (cURus)

E60693

Rated voltage (Use group B / UL 1059) 300 V

Rated voltage (Use group D / UL 1059) 300 V

Rated current (Use group B / UL 1059) 10 A

Rated current (Use group D / UL 1059) 10 A

Reference to approval values

Specifications are maximum values, details - see approval certificate.

Packing

Packaging

Box

VPE length

0 m

VPE width

0 m

VPE height

0 m

Classifications

ETIM 6.0

EC002637

ETIM 7.0

EC002637

eClass 9.0

27-44-04-02

eClass 9.1

27-44-04-02

eClass 10.0

27-44-04-02

Notes

Notes

- Additional colours on request
- Rated current related to rated cross-section & min. No. of poles.
- Rated data refer only to the component itself. Clearance and creepage distances to other components are to be designed in accordance with the relevant application standards.
- P on drawing = pitch

IPC conformity

Conformity: The products are developed, manufactured and delivered according international recognized standards and norms and comply with the assured properties in the data sheet resp. fulfill decorative properties in accordance with IPC-A-610 "Class 2". Further claims on the products can be evaluated on request.

Approvals

Approvals



ROHS

Conform

**OMNIMATE Signal - series BC/SC 3.81
SCD 3.81/22/180G 3.2SN OR BX**

Weidmüller Interface GmbH & Co. KG
Klingenbergstraße 26
D-32758 Detmold
Germany
Fon: +49 5231 14-0
Fax: +49 5231 14-292083
www.weidmueller.com

Technical data**Downloads**

Approval/Certificate/Document of Conformity	Declaration of the Manufacturer
Brochure/Catalogue	FL DRIVES EN MB DEVICE MANUF. EN FL DRIVES DE CAT 2 PORTFOLIOGUIDE EN FL BUILDING SAFETY EN FL APPL LED LIGHTING EN FL INDUSTR.CONTROLS EN FL MACHINE SAFETY EN FL HEATING ELECTR EN FL APPL INVERTER EN FL BASE STATION EN FL ELEVATOR EN FL POWER SUPPLY EN FL 72H SAMPLE SER EN PO OMNIMATE EN
Engineering Data	EPLAN_WSCAD
Engineering Data	STEP
Product Change Notification	Change of packaging - DE Change of packaging - EN

**OMNIMATE Signal - series BC/SC 3.81
SCD 3.81/22/180G 3.2SN OR BX**

Weidmüller Interface GmbH & Co. KG
 Klingenbergstraße 26
 D-32758 Detmold
 Germany
 Fon: +49 5231 14-0
 Fax: +49 5231 14-292083
 www.weidmueller.com

Drawings

Dimensional drawing

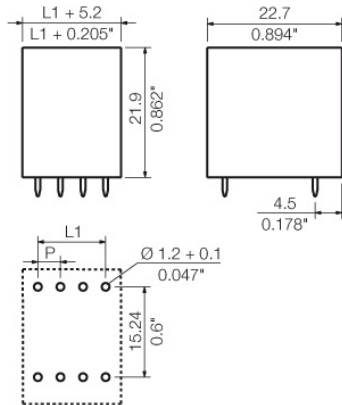

OMNIMATE Signal - series BC/SC 3.81 SCD 3.81/22/180G 3.2SN OR BX

Weidmüller Interface GmbH & Co. KG
 Klingenbergstraße 26
 D-32758 Detmold
 Germany
 Fon: +49 5231 14-0
 Fax: +49 5231 14-292083
 www.weidmueller.com

Accessories

Coding elements



**Only connects what is supposed to be connected:
the right connection at the right place.**

Coding elements and locking devices clearly assign connecting elements during the manufacturing process and operation

The coding elements and locking devices are inserted prior to assembly or during the cable assembly phase. The Weidmüller alternative: configure online using the variant configurator to precode prior to delivery.

Incorrect assembly on the circuit board and incorrect plugging of connecting elements is no longer possible. The advantage: no troubleshooting during manufacture and no operational errors by the user.

General ordering data

	Type	Version	Product data	Packaging
Type	SC-SMT 3.81 KO GY BX			
Order No.	1968900000	PCB plug-in connector, Accessories, Coding element, grey, Number of		Box
GTIN (EAN)	4032248772865	poles: 6		
Qty.	100 pc(s).			

04

SCD 3.81/.../180G 3.2...

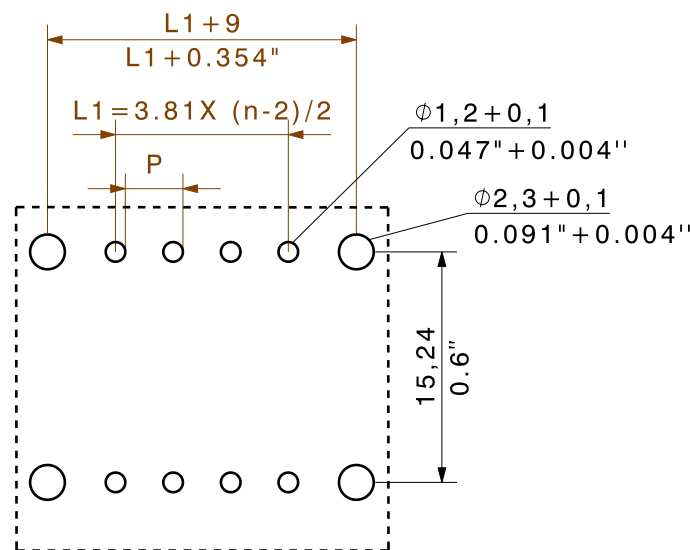
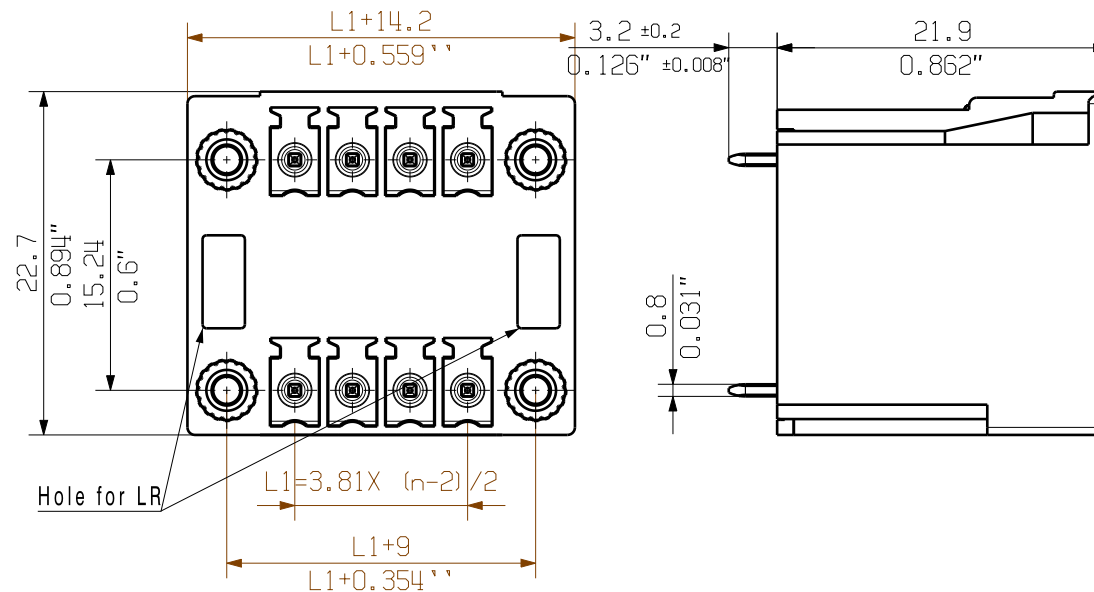
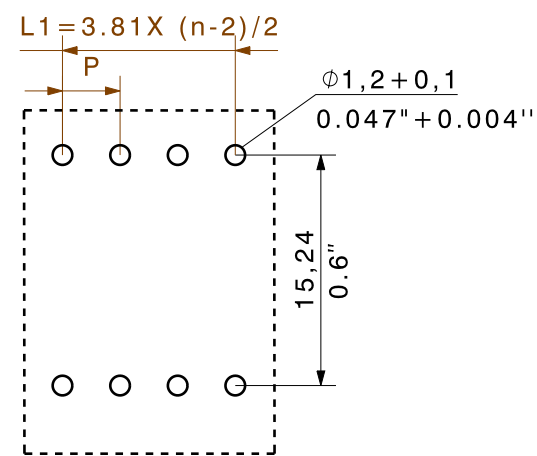
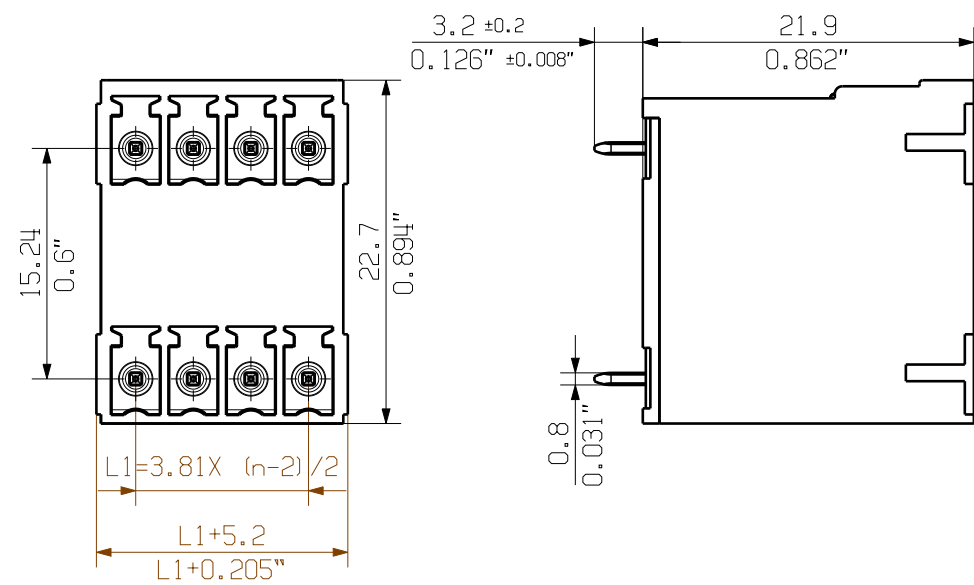

SCD 3.81/.../180F 3.2...
WITH
BCF 3.81/.../180 LR

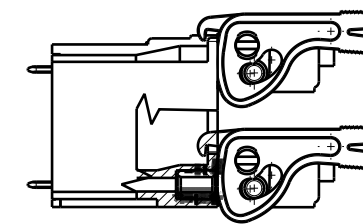

SCD 3.81/.../180F 3.2...
WITH
BCF 3.81/.../180 LR
M 1/1

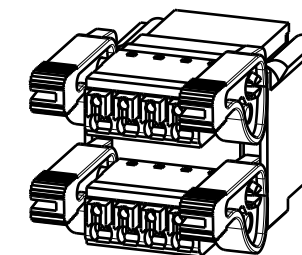

NOTE:

n=NO OF POLES
P=PITCH

KUNDENZEICHUNG
CUSTOMER DRAWING

For the mounting of PCBs, it should be noted that the rated data stated here relates only to the PCB components alone.
The necessary creepage and clearance paths must be observed in connection with the respective applicant in accordance to IEC 664 / VDE 0110.
The current-carrying capacity and pitch tolerance is to be determined according to DIN IEC 326 part 3 very fine.

Weidmüller PCB components are tested to the DIN EN 61984 standard, and are valid for its field of application. Provided that the components are used to the intended purpose, all requirements with respect to the occurring of electrical, mechanical, thermic and corrosive stress will be satisfied.

16	57.15	2.250
15	53.34	2.100
14	49.53	1.950
13	45.72	1.800
12	41.91	1.650
11	38.10	1.500
10	34.29	1.350
9	30.48	1.200
8	26.67	1.050
7	22.86	0.900
6	19.05	0.750
5	15.24	0.600
4	11.43	0.450
3	7.62	0.300
2	3.81	0.150
n	L1 [mm]	L1 [inch]

GENERAL TOLERANCE: DIN ISO 2768-m		99958/4 06.03.18 MA_J 01		Weidmüller		C 46286 04	
RoHS COMPLIANT Max. nos.		Modification		Drawing no.		Issue no.	
Scale: 5/1		Date		Name		Sheet 01 of 02 sheets	
Supersedes:		Drawn		Responsible		SCD... 3.81/.../180... THR-LOETANSCHLUSS STIFTLISTE THR SOLDER CONNECTION PIN HEADER	
Approved		Checked		Approved		Product file: SCD 3.81 7079	

Recommended wave soldering profiles

Weidmüller Interface GmbH & Co. KG
 Klängenbergstraße 16
 D-32758 Detmold
 Germany
 Fon: +49 5231 14-0
 Fax: +49 5231 14-292083
 www.weidmueller.com

Single Wave:



Double Wave:



Wave soldering profiles

Wired connection elements should be processed in accordance with the DIN EN 61760-1 standard. We have included two recommendations for practical wave soldering profiles, with which Weidmüller PCB terminals and connectors are qualified.

When choosing a suitable profile for your application, the following factors also need to be considered:

- PCB thickness
- Proportion of Cu in the layers
- Single/double-sided assembly
- Product range
- Heating and cooling rates

The single and double wave profiles each indicate the recommended operating range, including the maximum soldering temperature of 260°C. In practice, the maximum soldering temperature is quite often well below the above maximum profile.