

## OMNIMATE Signal - series BL/SL 5.08 BLDF 5.08/03/180F SN BK BX

**Weidmüller Interface GmbH & Co. KG**  
Klingenbergstraße 26  
D-32758 Detmold  
Germany  
Fon: +49 5231 14-0  
Fax: +49 5231 14-292083  
www.weidmueller.com

### Product image

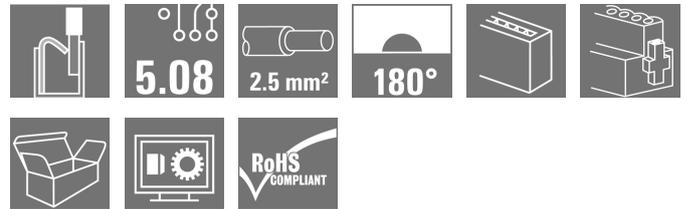

Similar to illustration

The powerful daisy-chain solution for high-performance signal bus applications is also suitable for 400V auxiliary power chains with 18.5A current-carrying capacity. The large clamping capacity (up to 2.5mm<sup>2</sup> wire cross-sections) is particularly beneficial for long bus cables or high currents because of the low voltage drop. Four flange variations, including the patented release latch, allow for user-friendly unplugging designs.

### General ordering data

Type	BLDF 5.08/03/180F SN BK BX
Order No.	<a href="#">1000950000</a>
Version	PCB plug-in connector, female plug, 5.08 mm, Number of poles: 3, 180°, PUSH IN, Spring connection, Clamping range, max. : 3.31 mm <sup>2</sup> , Box
GTIN (EAN)	4032248817085
Qty.	48 pc(s).
Product data	IEC: 400 V / 20.8 A / 0.2 - 2.5 mm <sup>2</sup> UL: 300 V / 18.5 A / AWG 12 - AWG 26
Packaging	Box

Creation date May 1, 2020 3:05:17 AM CEST

**OMNIMATE Signal - series BL/SL 5.08  
BLDF 5.08/03/180F SN BK BX**

**Weidmüller Interface GmbH & Co. KG**  
Klingenbergstraße 26  
D-32758 Detmold  
Germany  
Fon: +49 5231 14-0  
Fax: +49 5231 14-292083  
www.weidmueller.com

**Technical data****Dimensions and weights**

Width	25.04 mm	Width (inches)	0.986 inch
Height	24.7 mm	Height (inches)	0.972 inch
Depth	28.3 mm	Depth (inches)	1.114 inch
Net weight	9.74 g		

**System Parameters**

Product family	OMNIMATE Signal - series BL/SL 5.08	Type of connection	Field connection
Wire connection method	PUSH IN, Spring connection	Pitch in mm (P)	5.08 mm
Pitch in inches (P)	0.2 inch	Conductor outlet direction	180°
Number of poles	3	L1 in mm	10.16 mm
L1 in inches	0.4 inch	Number of rows	1
Pin series quantity	1	Rated cross-section	2.5 mm <sup>2</sup>
Touch-safe protection acc. to DIN VDE 57 106	Safe from finger touch	Touch-safe protection acc. to DIN VDE 0470	IP 20
Volume resistance	≤ 5mΩ	Can be coded	Yes
Stripping length	10 mm	Tightening torque for screw flange, min.	0.15 Nm
Tightening torque for screw flange, max.	0.2 Nm	Screwdriver blade	0.6 x 3.5
Screwdriver blade standard	DIN 5264	Plugging cycles	25
Plugging force/pole, max.	9.5 N	Pulling force/pole, max.	7.5 N

**Material data**

Insulating material	PBT	Colour	black
Colour of operational elements	orange	Material of operational elements	PBT
Colour chart (similar)	RAL 9011	Insulating material group	IIIa
Comparative Tracking Index (CTI)	≥ 200	Insulation strength	≥ 10 <sup>8</sup> Ω
UL 94 flammability rating	V-0	GWFI	960 °C
Contact material	CuSn	Contact surface	tinned
Layer structure of plug contact	4-8 μm Sn hot-dip tinned	Storage temperature, min.	-25 °C
Storage temperature, max.	50 °C	Max. relative humidity during storage	70 %
Operating temperature, min.	-50 °C	Operating temperature, max.	100 °C
Temperature range, installation, min.	-30 °C	Temperature range, installation, max.	100 °C

**Conductors suitable for connection**

Clamping range, min.	0.13 mm <sup>2</sup>
Clamping range, max.	3.31 mm <sup>2</sup>
Wire connection cross section AWG, min.	AWG 26
Wire connection cross section AWG, max.	AWG 12
Solid, min. H05(07) V-U	0.2 mm <sup>2</sup>
Solid, max. H05(07) V-U	2.5 mm <sup>2</sup>
Flexible, min. H05(07) V-K	0.2 mm <sup>2</sup>
Flexible, max. H05(07) V-K	2.5 mm <sup>2</sup>
w. plastic collar ferrule, DIN 46228 pt 4, min.	0.25 mm <sup>2</sup>
w. plastic collar ferrule, DIN 46228 pt 4, max.	2.5 mm <sup>2</sup>
w. wire end ferrule, DIN 46228 pt 1, min.	0.25 mm <sup>2</sup>
w. wire end ferrule, DIN 46228 pt 1, max.	2.5 mm <sup>2</sup>

Creation date May 1, 2020 3:05:17 AM CEST

## OMNIMATE Signal - series BL/SL 5.08 BLDF 5.08/03/180F SN BK BX

**Weidmüller Interface GmbH & Co. KG**  
Klingenbergstraße 26  
D-32758 Detmold  
Germany  
Fon: +49 5231 14-0  
Fax: +49 5231 14-292083  
www.weidmueller.com

## Technical data

Plug gauge in accordance with EN 60999 a x b; ø

2.8 mm x 2.0 mm

Clampable conductor	Cross-section for conductor connection	Type	fine-wired
		nominal	0.5 mm <sup>2</sup>
wire end ferrule	wire end ferrule	Stripping length	nominal 12 mm
		Recommended wire-end ferrule	<a href="#">H0.5/16 OR</a>
		Stripping length	nominal 10 mm
		Recommended wire-end ferrule	<a href="#">H0.5/10</a>
Cross-section for conductor connection	Type	fine-wired	
	nominal	0.75 mm <sup>2</sup>	
wire end ferrule	wire end ferrule	Stripping length	nominal 12 mm
		Recommended wire-end ferrule	<a href="#">H0.75/16 W</a>
		Stripping length	nominal 10 mm
		Recommended wire-end ferrule	<a href="#">H0.75/10</a>
Cross-section for conductor connection	Type	fine-wired	
	nominal	1 mm <sup>2</sup>	
wire end ferrule	wire end ferrule	Stripping length	nominal 12 mm
		Recommended wire-end ferrule	<a href="#">H1.0/16D R</a>
		Stripping length	nominal 10 mm
		Recommended wire-end ferrule	<a href="#">H1.0/10</a>
Cross-section for conductor connection	Type	fine-wired	
	nominal	1.5 mm <sup>2</sup>	
wire end ferrule	wire end ferrule	Stripping length	nominal 10 mm
		Recommended wire-end ferrule	<a href="#">H1.5/10</a>
		Stripping length	nominal 12 mm
		Recommended wire-end ferrule	<a href="#">H1.5/16 R</a>
Cross-section for conductor connection	Type	fine-wired	
	nominal	2.5 mm <sup>2</sup>	
wire end ferrule	wire end ferrule	Stripping length	nominal 10 mm
		Recommended wire-end ferrule	<a href="#">H2.5/10</a>
		Stripping length	nominal 13 mm
		Recommended wire-end ferrule	<a href="#">H2.5/16DS BL</a>
Reference text	The outside diameter of the plastic collar should not be larger than the pitch (P). Length of ferrules is to be chosen depending on the product and the rated voltage.		
Max. clamping range	3.31 mm <sup>2</sup>		

**OMNIMATE Signal - series BL/SL 5.08  
BLDF 5.08/03/180F SN BK BX**

**Weidmüller Interface GmbH & Co. KG**  
Klingenbergstraße 26  
D-32758 Detmold  
Germany  
Fon: +49 5231 14-0  
Fax: +49 5231 14-292083  
www.weidmueller.com

**Technical data****Rated data acc. to IEC**

tested acc. to standard	IEC 60664-1, IEC 61984	Rated current, min. number of poles (Tu=20°C)	20.8 A
Rated current, max. number of poles (Tu=20°C)	17.4 A	Rated current, min. number of poles (Tu=40°C)	17.9 A
Rated current, max. number of poles (Tu=40°C)	14.9 A	Rated current cross-connector, min. number of poles (Ta=20°C)	28.1 A
Rated current cross-connector, max. number of poles (Ta=20°C)	23.3 A	Rated current cross-connector, min. number of poles (Ta=40°C)	24.2 A
Rated current cross-connector, max. number of poles (Ta=40°C)	19.9 A	Rated voltage for surge voltage class / pollution degree II/2	400 V
Rated voltage for surge voltage class / pollution degree III/2	320 V	Rated voltage for surge voltage class / pollution degree III/3	250 V
Rated impulse voltage for surge voltage class/ pollution degree II/2	4 kV	Rated impulse voltage for surge voltage class/ pollution degree III/2	4 kV
Rated impulse voltage for surge voltage class/ contamination degree III/3	4 kV	Short-time withstand current resistance	3 x 1s with 120 A

**Rated data acc. to CSA**

Institute (CSA)		Certificate No. (CSA)	200039-1121690
Rated voltage (Use group B / CSA)	300 V	Rated voltage (Use group D / CSA)	300 V
Rated current (Use group B / CSA)	18.5 A	Rated current (Use group D / CSA)	10 A
Wire cross-section, AWG, min.	AWG 12	Wire cross-section, AWG, max.	AWG 26
Reference to approval values	Specifications are maximum values, details - see approval certificate.		

**Rated data acc. to UL 1059**

Institute (cURus)		Certificate No. (cURus)	E60693
Rated voltage (Use group B / UL 1059)	300 V	Rated voltage (Use group D / UL 1059)	300 V
Rated current (Use group B / UL 1059)	18.5 A	Rated current (Use group D / UL 1059)	10 A
Wire cross-section, AWG, min.	AWG 12	Wire cross-section, AWG, max.	AWG 26
Reference to approval values	Specifications are maximum values, details - see approval certificate.		

**Packing**

Packaging	Box	VPE length	35 mm
VPE width	135 mm	VPE height	350 mm

**Cross-connector rated data according to DIN IEC**

Rated current cross-connector, min. number of poles (Ta=20°C)	28.1 A	Rated current cross-connector, max. number of poles (Ta=20°C)	23.3 A
Rated current cross-connector, min. number of poles (Ta=40°C)	24.2 A	Rated current cross-connector, max. number of poles (Ta=40°C)	19.9 A

**OMNIMATE Signal - series BL/SL 5.08  
BLDF 5.08/03/180F SN BK BX**

**Weidmüller Interface GmbH & Co. KG**  
 Klingenbergstraße 26  
 D-32758 Detmold  
 Germany  
 Fon: +49 5231 14-0  
 Fax: +49 5231 14-292083  
 www.weidmueller.com

**Technical data****Classifications**

ETIM 6.0	EC002638	ETIM 7.0	EC002638
eClass 9.0	27-44-03-09	eClass 9.1	27-44-03-09
eClass 10.0	27-44-03-09		

**Notes**

Notes	<ul style="list-style-type: none"> <li>• Additional colours on request</li> <li>• Gold-plated contact surfaces on request</li> <li>• Rated current related to rated cross-section &amp; min. No. of poles.</li> <li>• Wire end ferrule without plastic collar to DIN 46228/1</li> <li>• Wire end ferrule with plastic collar to DIN 46228/4</li> <li>• P on drawing = pitch</li> <li>• Crimping shape "A" for wire end ferrules with PZ 6/5 crimping tool recommended.</li> <li>• The test point can only be used as potential-pickup point.</li> </ul>
IPC conformity	Conformity: The products are developed, manufactured and delivered according international recognized standards and norms and comply with the assured properties in the data sheet resp. fulfill decorative properties in accordance with IPC-A-610 "Class 2". Further claims on the products can be evaluated on request.

**Approvals**

Approvals



ROHS Conform

**Downloads**

Approval/Certificate/Document of Conformity	<a href="#">Declaration of the Manufacturer</a>
Brochure/Catalogue	<a href="#">FL DRIVES EN</a> <a href="#">MB DEVICE MANUF. EN</a> <a href="#">FL DRIVES DE</a> <a href="#">CAT 2 PORTFOLIOGUIDE EN</a> <a href="#">FL BUILDING SAFETY EN</a> <a href="#">FL APPL LED LIGHTING EN</a> <a href="#">FLIndustr.CONTROLS EN</a> <a href="#">FL MACHINE SAFETY EN</a> <a href="#">FL HEATING ELECTR EN</a> <a href="#">FL APPL INVERTER EN</a> <a href="#">FL_BASE_STATION EN</a> <a href="#">FL ELEVATOR EN</a> <a href="#">FL POWER SUPPLY EN</a> <a href="#">FL 72H SAMPLE SER EN</a> <a href="#">PO OMNIMATE EN</a>
Engineering Data	<a href="#">EPLAN_WSCAD</a>
Engineering Data	<a href="#">STEP</a>
White paper PUSH IN wire connection	<a href="#">Download Whitepaper</a>

Creation date May 1, 2020 3:05:17 AM CEST

Catalogue status 17.04.2020 / We reserve the right to make technical changes.

5

**OMNIMATE Signal - series BL/SL 5.08  
BLDF 5.08/03/180F SN BK BX**

**Weidmüller Interface GmbH & Co. KG**  
Klingenbergstraße 26  
D-32758 Detmold  
Germany  
Fon: +49 5231 14-0  
Fax: +49 5231 14-292083  
www.weidmueller.com

**Drawings**

**Dimensional drawing**

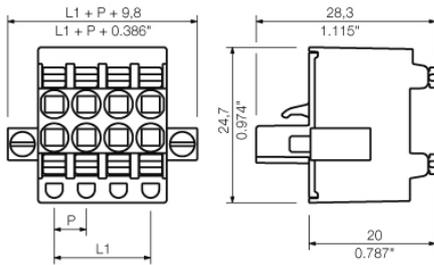

**Graph**

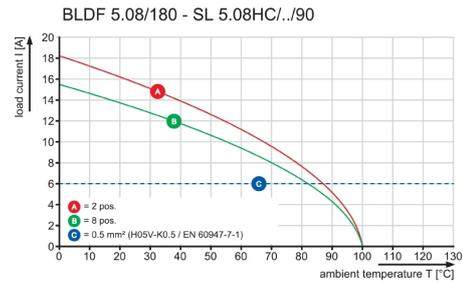

**Graph**

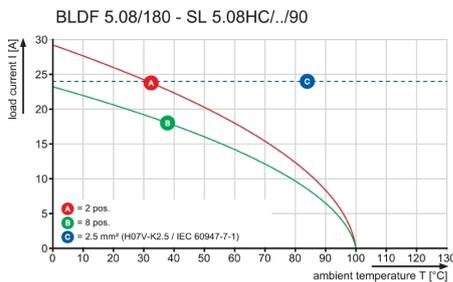

**Graph**

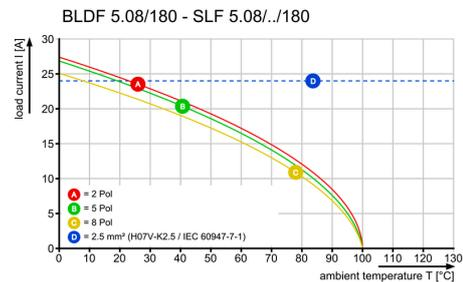

**Product benefits**



Solid PUSH IN contact  
Safe and durable

**Product benefits**



Cost-effective wiring  
Quick and intuitive operation

**OMNIMATE Signal - series BL/SL 5.08  
BLDF 5.08/03/180F SN BK BX**

**Weidmüller Interface GmbH & Co. KG**  
Klingenbergstraße 26  
D-32758 Detmold  
Germany  
Fon: +49 5231 14-0  
Fax: +49 5231 14-292083  
www.weidmueller.com

**Mating connector (fully pluggable)**
**SL-SMT 5.08/180LF Tape**

High-temperature-resistant pin header, packed in box or tape. On tape, with 1.5 mm solder pin, optimised for automatic assembly. 3.2 mm solder pin suitable for reflow and wave soldering. The pin headers provide space for labelling and can be coded. HC = High Current.

**General ordering data**

Type	SL-SMT 5.08HC/03/180LF ...	Version	Product data	Packaging
Order No.	<a href="#">1776374001</a>	PCB plug-in connector, male header, Solder flange, THT/THR solder connection, 5.08 mm, Number of poles: 3, 180°, Solder pin length (l): 1.5 mm, tinned, black, Tape	IEC: 400 V / 27.5 A UL: 300 V / 18.5 A	Tape
GTIN (EAN)	4032248163496			
Qty.	250 pc(s).			

**SL-SMT 5.08/270FL Box**

High-temperature-resistant, straight, open pin header. Packed in box or tape. On tape and with 1.5 mm solder pin, optimised for automatic assembly. 3.2 mm solder pin suitable for reflow and wave soldering. The pin headers provide space for labelling and can be coded. HC = High Current.

**General ordering data**

Type	SL-SMT 5.08HC/03/270FL ...	Version	Product data	Packaging
Order No.	<a href="#">1876860000</a>	PCB plug-in connector, male header, Solder flange, THT/THR solder connection, 5.08 mm, Number of poles: 3, 270°, Solder pin length (l): 3.2 mm, tinned, black, Box	IEC: 400 V / 27.5 A UL: 300 V / 18.5 A	Box
GTIN (EAN)	4032248467440			
Qty.	100 pc(s).			
Type	SL-SMT 5.08HC/03/270FL ...	Version	Product data	Packaging
Order No.	<a href="#">1878110000</a>	PCB plug-in connector, male header, Solder flange, THT/THR solder connection, 5.08 mm, Number of poles: 3, 270°, Solder pin length (l): 1.5 mm, tinned, black, Box	IEC: 400 V / 27.5 A UL: 300 V / 18.5 A	Box
GTIN (EAN)	4032248468911			
Qty.	100 pc(s).			

**OMNIMATE Signal - series BL/SL 5.08  
BLDF 5.08/03/180F SN BK BX**

**Weidmüller Interface GmbH & Co. KG**  
Klingenbergstraße 26  
D-32758 Detmold  
Germany  
Fon: +49 5231 14-0  
Fax: +49 5231 14-292083  
www.weidmueller.com

**Mating connector (fully pluggable)**
**SL-SMT 5.08HC/90LF Tape**

High-temperature-resistant pin header, packed in box or tape. On tape, with 1.5 mm solder pin, optimised for automatic assembly. 3.2 mm solder pin suitable for reflow and wave soldering. The pin headers provide space for labelling and can be coded. HC = High Current.

**General ordering data**

Type	SL-SMT 5.08HC/03/90LF 1 ...	Version	Product data	Packaging
Order No.	<a href="#">1775244001</a>	PCB plug-in connector, male header, Solder flange, THT/THR solder connection, 5.08 mm, Number of poles: 3, 90°, Solder pin length (l): 1.5 mm, tinned, black, Tape	IEC: 400 V / 27.5 A UL: 300 V / 18.5 A	Tape
GTIN (EAN)	4032248167791			
Qty.	350 pc(s).			

**SL-SMT 5.08/180F Box**

High-temperature-resistant pin header, packed in box or tape. On tape, with 1.5 mm solder pin, optimised for automatic assembly. 3.2 mm solder pin suitable for reflow and wave soldering. The pin headers provide space for labelling and can be coded. HC = High Current.

**General ordering data**

Type	SL-SMT 5.08HC/03/180F 3 ...	Version	Product data	Packaging
Order No.	<a href="#">1820600000</a>	PCB plug-in connector, male header, Flange, THT/THR solder connection, 5.08 mm, Number of poles: 3, 180°, Solder pin length (l): 3.2 mm, tinned, black, Box	IEC: 400 V / 27.5 A UL: 300 V / 18.5 A	Box
GTIN (EAN)	4032248316564			
Qty.	72 pc(s).			

**OMNIMATE Signal - series BL/SL 5.08  
BLDF 5.08/03/180F SN BK BX**

**Weidmüller Interface GmbH & Co. KG**  
Klingenbergstraße 26  
D-32758 Detmold  
Germany  
Fon: +49 5231 14-0  
Fax: +49 5231 14-292083  
www.weidmueller.com

**Mating connector (fully pluggable)**
**SL-SMT 5.08/270FH Box**

High-temperature-resistant, straight, open pin header. Packed in box or tape. On tape and with 1.5 mm solder pin, optimised for automatic assembly. 3.2 mm solder pin suitable for reflow and wave soldering. The pin headers provide space for labelling and can be coded. HC = High Current.

**General ordering data**

Type	SL-SMT 5.08/03/270FH 1. ...	Version	Product data	Packaging
Order No.	<a href="#">1877970000</a>	PCB plug-in connector, male header, Solder flange, THT/THR solder connection, 5.08 mm, Number of poles: 3, 270°, Solder pin length (l): 1.5 mm, tinned, black, Box	IEC: 400 V / 27.5 A UL: 300 V / 18.5 A	Box
GTIN (EAN)	4032248468720			
Qty.	100 pc(s).			
Type	SL-SMT 5.08HC/03/270FH ...	Version	Product data	Packaging
Order No.	<a href="#">1877210000</a>	PCB plug-in connector, male header, Solder flange, THT/THR solder connection, 5.08 mm, Number of poles: 3, 270°, Solder pin length (l): 3.2 mm, tinned, black, Box	IEC: 400 V / 27.5 A UL: 300 V / 18.5 A	Box
GTIN (EAN)	4032248467778			
Qty.	100 pc(s).			

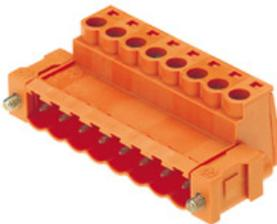
**SLS 5.08/180FI**

Male plugs with clamping-yoke screw wire-connect system. The male plugs provide space for labelling and can be coded.

**General ordering data**

Type	SLS 5.08/03/180FI SN OR ...	Version	Product data	Packaging
Order No.	<a href="#">1846220000</a>	PCB plug-in connector, male plug, 5.08 mm, Number of poles: 3, 180°, Clamping yoke connection, Clamping range, max. : 3.31 mm², UL: 300 V / 14 A / AWG 26 - AWG 12	IEC: 400 V / 21.5 A / 0.2 - 2.5 mm² UL: 300 V / 14 A / AWG 26 - AWG 12	Box
GTIN (EAN)	4032248362509			
Qty.	72 pc(s).			

**OMNIMATE Signal - series BL/SL 5.08  
BLDF 5.08/03/180F SN BK BX**

**Weidmüller Interface GmbH & Co. KG**  
Klingenbergstraße 26  
D-32758 Detmold  
Germany  
Fon: +49 5231 14-0  
Fax: +49 5231 14-292083  
www.weidmueller.com

**Mating connector (fully pluggable)**
**SLS 5.08/180F**

Male plugs with clamping-yoke screw wire-connect system. The male plugs provide space for labelling and can be coded.

**General ordering data**

Type	SLS 5.08/03/180F SN OR ...	Version	Product data	Packaging
Order No.	<a href="#">1846370000</a>	PCB plug-in connector, male plug, 5.08 mm, Number of poles: 3,	IEC: 400 V / 21.5 A / 0.2 - 2.5 mm <sup>2</sup>	Box
GTIN (EAN)	4032248362073	180°, Clamping yoke connection, Clamping range, max. : 3.31 mm <sup>2</sup> ,	UL: 300 V / 14 A / AWG 26 - AWG 12	
Qty.	72 pc(s).	Box		

**SL-SMT 5.08/270FH Tape**

High-temperature-resistant, straight, open pin header. Packed in box or tape. On tape and with 1.5 mm solder pin, optimised for automatic assembly. 3.2 mm solder pin suitable for reflow and wave soldering. The pin headers provide space for labelling and can be coded. HC = High Current.

**General ordering data**

Type	SL-SMT 5.08HC/03/270FH ...	Version	Product data	Packaging
Order No.	<a href="#">1876930000</a>	PCB plug-in connector, male header, Solder flange, THT/THR solder	IEC: 400 V / 27.5 A	Tape
GTIN (EAN)	4032248467389	connection, 5.08 mm, Number of poles: 3, 270°, Solder pin length (l):	UL: 300 V / 18.5 A	
Qty.	225 pc(s).	1.5 mm, tinned, black, Tape		
Type	SL-SMT 5.08/03/270FH 3. ...	Version	Product data	Packaging
Order No.	<a href="#">1876830000</a>	PCB plug-in connector, male header, Solder flange, THT/THR solder	IEC: 400 V / 27.5 A	Tape
GTIN (EAN)	4032248467365	connection, 5.08 mm, Number of poles: 3, 270°, Solder pin length (l):	UL: 300 V / 18.5 A	
Qty.	335 pc(s).	3.2 mm, tinned, black, Tape		

**OMNIMATE Signal - series BL/SL 5.08  
BLDF 5.08/03/180F SN BK BX**

**Weidmüller Interface GmbH & Co. KG**  
Klingenbergstraße 26  
D-32758 Detmold  
Germany  
Fon: +49 5231 14-0  
Fax: +49 5231 14-292083  
www.weidmueller.com

**Mating connector (fully pluggable)**
**SLDV-THR 5.08/180F**

High-temperature resistant, double level, laterally offset, male connector with flange or solder flange. 1.5 mm solder pin is suitable for reflow soldering. 3.2 mm solder pin suitable for reflow and wave soldering. The pin headers provide space for labelling and can be coded.

**General ordering data**

Type	SLDV-THR 5.08/06/180F 1 ...	Version	Product data	Packaging
Order No.	<a href="#">1828900000</a>	PCB plug-in connector, male header, Flange, THT/THR solder connection, 5.08 mm, Number of poles: 6, 180°, Solder pin length (l): 1.5 mm, tinned, black, Box	IEC: 400 V / 15 A UL: 300 V / 10 A	Box
GTIN (EAN)	4032248335596			
Qty.	50 pc(s).			
Type	SLDV-THR 5.08/06/180F 3 ...	Version	Product data	Packaging
Order No.	<a href="#">1828780000</a>	PCB plug-in connector, male header, Flange, THT/THR solder connection, 5.08 mm, Number of poles: 6, 180°, Solder pin length (l): 3.2 mm, tinned, black, Box	IEC: 400 V / 15 A UL: 300 V / 10 A	Box
GTIN (EAN)	4032248335466			
Qty.	50 pc(s).			

**SL 5.08HC/180LF**

Pin headers in glass-fibre-reinforced plastic with straight wire outlet; optimised for wave soldering. The flange variant (F) can be screwed onto the respective counter piece or the circuit board. There is no need for an extra screw to connect the circuit board when the solder flange (LF) version is used. This also protects the solder points from mechanical strain. All pin headers can be manually coded or ordered pre-coded. HC = High Current.

**General ordering data**

Type	SL 5.08HC/03/180LF 3.2S ...	Version	Product data	Packaging
Order No.	<a href="#">1149250000</a>	PCB plug-in connector, male header, Solder flange, THT solder connection, 5.08 mm, Number of poles: 3, 180°, Solder pin length (l): 3.2 mm, tinned, black, Box	IEC: 400 V / 24 A UL: 300 V / 18.5 A	Box
GTIN (EAN)	4032248932207			
Qty.	72 pc(s).			
Type	SL 5.08HC/03/180LF 3.2S ...	Version	Product data	Packaging
Order No.	<a href="#">1147920000</a>	PCB plug-in connector, male header, Solder flange, THT solder connection, 5.08 mm, Number of poles: 3, 180°, Solder pin length (l): 3.2 mm, tinned, orange, Box	IEC: 400 V / 24 A UL: 300 V / 18.5 A	Box
GTIN (EAN)	4032248931705			
Qty.	72 pc(s).			

**OMNIMATE Signal - series BL/SL 5.08  
BLDF 5.08/03/180F SN BK BX**

**Weidmüller Interface GmbH & Co. KG**  
Klingenbergstraße 26  
D-32758 Detmold  
Germany  
Fon: +49 5231 14-0  
Fax: +49 5231 14-292083  
www.weidmueller.com

**Mating connector (fully pluggable)**
**SLDV-THR 5.08/180FLF**

High-temperature resistant, double level, laterally offset, male connector with flange or solder flange. 1.5 mm solder pin is suitable for reflow soldering. 3.2 mm solder pin suitable for reflow and wave soldering. The pin headers provide space for labelling and can be coded.

**General ordering data**

Type	SLDV-THR 5.08/06/180FLF ...	Version	Product data	Packaging
Order No.	<a href="#">1829020000</a>	PCB plug-in connector, male header, Flange / Solder flange, THT/THR	IEC: 400 V / 15 A	Box
GTIN (EAN)	4032248335718	solder connection, 5.08 mm, Number of poles: 6, 180°, Solder pin	UL: 300 V / 10 A	
Qty.	50 pc(s).	length (l): 3.2 mm, tinned, black, Box		
Type	SLDV-THR 5.08/06/180FLF ...	Version	Product data	Packaging
Order No.	<a href="#">1829140000</a>	PCB plug-in connector, male header, Flange / Solder flange, THT/THR	IEC: 400 V / 15 A	Box
GTIN (EAN)	4032248335831	solder connection, 5.08 mm, Number of poles: 6, 180°, Solder pin	UL: 300 V / 10 A	
Qty.	50 pc(s).	length (l): 1.5 mm, tinned, black, Box		

**SL-SMT 5.08HC/90F Box**

High-temperature-resistant pin header, packed in box or tape. On tape, with 1.5 mm solder pin, optimised for automatic assembly. 3.2 mm solder pin suitable for reflow and wave soldering. The pin headers provide space for labelling and can be coded. HC = High Current.

**General ordering data**

Type	SL-SMT 5.08HC/03/90F 3. ...	Version	Product data	Packaging
Order No.	<a href="#">1837640000</a>	PCB plug-in connector, male header, Flange, THT/THR solder	IEC: 400 V / 27.5 A	Box
GTIN (EAN)	4032248347452	connection, 5.08 mm, Number of poles: 3, 90°, Solder pin length (l):	UL: 300 V / 18.5 A	
Qty.	72 pc(s).	3.2 mm, tinned, black, Box		

**OMNIMATE Signal - series BL/SL 5.08  
BLDF 5.08/03/180F SN BK BX**

**Weidmüller Interface GmbH & Co. KG**  
Klingenbergstraße 26  
D-32758 Detmold  
Germany  
Fon: +49 5231 14-0  
Fax: +49 5231 14-292083  
www.weidmueller.com

**Mating connector (fully pluggable)**
**SL-SMT 5.08/180LF Box**

High-temperature-resistant pin header, packed in box or tape. On tape, with 1.5 mm solder pin, optimised for automatic assembly. 3.2 mm solder pin suitable for reflow and wave soldering. The pin headers provide space for labelling and can be coded. HC = High Current.

**General ordering data**

Type	SL-SMT 5.08HC/03/180LF ...	Version	Product data	Packaging
Order No.	<a href="#">1776372001</a>	PCB plug-in connector, male header, Solder flange, THT/THR solder connection, 5.08 mm, Number of poles: 3, 180°, Solder pin length (l): 1.5 mm, tinned, black, Box	IEC: 400 V / 27.5 A UL: 300 V / 18.5 A	Box
GTIN (EAN)	4032248159154			
Qty.	72 pc(s).			
Type	SL-SMT 5.08HC/03/180LF ...	Version	Product data	Packaging
Order No.	<a href="#">2086580000</a>	PCB plug-in connector, male header, Solder flange, THT/THR solder connection, 5.08 mm, Number of poles: 3, 180°, Solder pin length (l): 5.5 mm, tinned, black, Box	IEC: 400 V / 27.5 A UL: 300 V / 18.5 A	Box
GTIN (EAN)	4050118420517			
Qty.	144 pc(s).			
Type	SL-SMT 5.08HC/03/180LF ...	Version	Product data	Packaging
Order No.	<a href="#">1838450000</a>	PCB plug-in connector, male header, Solder flange, THT/THR solder connection, 5.08 mm, Number of poles: 3, 180°, Solder pin length (l): 3.2 mm, tinned, black, Box	IEC: 400 V / 27.5 A UL: 300 V / 18.5 A	Box
GTIN (EAN)	4032248348510			
Qty.	72 pc(s).			

**SL 5.08HC/90F**

Pin headers made from glass-fibre-reinforced plastic with 90° wire outlet; optimised for wave soldering. The flange variant (F) can be screwed onto the respective counter piece or the circuit board. There is no need for an extra screw to connect the circuit board when the solder flange (LF) version is used. This also protects the solder points from mechanical strain. All pin headers can be manually coded or ordered pre-coded. HC = High Current.

**General ordering data**

Type	SL 5.08HC/03/90F 3.2SN ...	Version	Product data	Packaging
Order No.	<a href="#">1150100000</a>	PCB plug-in connector, male header, Flange, THT solder connection, 5.08 mm, Number of poles: 3, 90°, Solder pin length (l): 3.2 mm, tinned, black, Box	IEC: 400 V / 24 A UL: 300 V / 18.5 A	Box
GTIN (EAN)	4032248936298			
Qty.	72 pc(s).			
Type	SL 5.08HC/03/90F 3.2SN ...	Version	Product data	Packaging
Order No.	<a href="#">1148640000</a>	PCB plug-in connector, male header, Flange, THT solder connection, 5.08 mm, Number of poles: 3, 90°, Solder pin length (l): 3.2 mm, tinned, orange, Box	IEC: 400 V / 24 A UL: 300 V / 18.5 A	Box
GTIN (EAN)	4032248935987			
Qty.	72 pc(s).			

**OMNIMATE Signal - series BL/SL 5.08  
BLDF 5.08/03/180F SN BK BX**

**Weidmüller Interface GmbH & Co. KG**  
 Klingenbergstraße 26  
 D-32758 Detmold  
 Germany  
 Fon: +49 5231 14-0  
 Fax: +49 5231 14-292083  
 www.weidmueller.com

**Mating connector (fully pluggable)****SL-SMT 5.08/270FL Tape**

High-temperature-resistant, straight, open pin header. Packed in box or tape. On tape and with 1.5 mm solder pin, optimised for automatic assembly. 3.2 mm solder pin suitable for reflow and wave soldering. The pin headers provide space for labelling and can be coded. HC = High Current.

**General ordering data**

Type	SL-SMT 5.08HC/03/270FL ...	Version	Product data	Packaging
Order No.	<a href="#">1876720000</a>	PCB plug-in connector, male header, Solder flange, THT/THR solder connection, 5.08 mm, Number of poles: 3, 270°, Solder pin length (l): 3.2 mm, tinned, black, Tape	IEC: 400 V / 27.5 A UL: 300 V / 18.5 A	Tape
GTIN (EAN)	4032248467235			
Qty.	350 pc(s).			
Type	SL-SMT 5.08HC/03/270FL ...	Version	Product data	Packaging
Order No.	<a href="#">1877000000</a>	PCB plug-in connector, male header, Solder flange, THT/THR solder connection, 5.08 mm, Number of poles: 3, 270°, Solder pin length (l): 1.5 mm, tinned, black, Tape	IEC: 400 V / 27.5 A UL: 300 V / 18.5 A	Tape
GTIN (EAN)	4032248467655			
Qty.	350 pc(s).			

**SL-SMT 5.08HC/90LF Box**

High-temperature-resistant pin header, packed in box or tape. On tape, with 1.5 mm solder pin, optimised for automatic assembly. 3.2 mm solder pin suitable for reflow and wave soldering. The pin headers provide space for labelling and can be coded. HC = High Current.

**General ordering data**

Type	SL-SMT 5.08HC/03/90LF 3 ...	Version	Product data	Packaging
Order No.	<a href="#">1780420000</a>	PCB plug-in connector, male header, Solder flange, THT/THR solder connection, 5.08 mm, Number of poles: 3, 90°, Solder pin length (l): 3.2 mm, tinned, black, Box	IEC: 400 V / 27.5 A UL: 300 V / 18.5 A	Box
GTIN (EAN)	4032248165742			
Qty.	72 pc(s).			
Type	SL-SMT 5.08HC/03/90LF 1 ...	Version	Product data	Packaging
Order No.	<a href="#">1775242001</a>	PCB plug-in connector, male header, Solder flange, THT/THR solder connection, 5.08 mm, Number of poles: 3, 90°, Solder pin length (l): 1.5 mm, tinned, black, Box	IEC: 400 V / 27.5 A UL: 300 V / 18.5 A	Box
GTIN (EAN)	4032248157228			
Qty.	72 pc(s).			

**OMNIMATE Signal - series BL/SL 5.08  
BLDF 5.08/03/180F SN BK BX**

**Weidmüller Interface GmbH & Co. KG**  
Klingenbergstraße 26  
D-32758 Detmold  
Germany  
Fon: +49 5231 14-0  
Fax: +49 5231 14-292083  
www.weidmueller.com

**Mating connector (fully pluggable)**
**SLF 5.08/180FI SN**

Male plug with PUSH IN wire connection and straight outlet direction, when used with BLF 5.08HC as wire-to-wire application for panel feed-through. The male plugs provide space for labelling and can be coded.

**General ordering data**

Type	SLF 5.08/03/180FI SN BK ...	Version	Product data	Packaging
Order No.	<a href="#">1336050000</a>	PCB plug-in connector, male plug, 5.08 mm, Number of poles: 3,	IEC: 400 V / 25.9 A / 0.2 - 2.5 mm <sup>2</sup>	Box
GTIN (EAN)	4050118139631	180°, PUSH IN, Spring connection, Clamping range, max.: 3.31 mm <sup>2</sup> , UL: 300 V / 14 A / AWG 26 - AWG 12		
Qty.	72 pc(s).	Box		
Type	SLF 5.08/03/180FI SN OR ...	Version	Product data	Packaging
Order No.	<a href="#">1336410000</a>	PCB plug-in connector, male plug, 5.08 mm, Number of poles: 3,	IEC: 400 V / 25.9 A / 0.2 - 2.5 mm <sup>2</sup>	Box
GTIN (EAN)	4050118140286	180°, PUSH IN, Spring connection, Clamping range, max.: 3.31 mm <sup>2</sup> , UL: 300 V / 14 A / AWG 26 - AWG 12		
Qty.	72 pc(s).	Box		

**SL 5.08HC/90LF**

Pin headers made from glass-fibre-reinforced plastic with 90° wire outlet; optimised for wave soldering. The flange variant (F) can be screwed onto the respective counter piece or the circuit board. There is no need for an extra screw to connect the circuit board when the solder flange (LF) version is used. This also protects the solder points from mechanical strain. All pin headers can be manually coded or ordered pre-coded. HC = High Current.

**General ordering data**

Type	SL 5.08HC/03/90LF 3.2SN ...	Version	Product data	Packaging
Order No.	<a href="#">1149410000</a>	PCB plug-in connector, male header, Solder flange, THT solder	IEC: 400 V / 24 A	Box
GTIN (EAN)	4032248936700	connection, 5.08 mm, Number of poles: 3, 90°, Solder pin length (l):	UL: 300 V / 18.5 A	
Qty.	72 pc(s).	3.2 mm, tinned, orange, Box		
Type	SL 5.08HC/03/90LF 3.2SN ...	Version	Product data	Packaging
Order No.	<a href="#">1150350000</a>	PCB plug-in connector, male header, Solder flange, THT solder	IEC: 400 V / 24 A	Box
GTIN (EAN)	4032248937431	connection, 5.08 mm, Number of poles: 3, 90°, Solder pin length (l):	UL: 300 V / 18.5 A	
Qty.	72 pc(s).	3.2 mm, tinned, black, Box		

**OMNIMATE Signal - series BL/SL 5.08  
BLDF 5.08/03/180F SN BK BX**

**Weidmüller Interface GmbH & Co. KG**  
Klingenbergstraße 26  
D-32758 Detmold  
Germany  
Fon: +49 5231 14-0  
Fax: +49 5231 14-292083  
www.weidmueller.com

**Mating connector (fully pluggable)**
**SLF 5.08/180F SN**

Male plug with PUSH IN wire connection and straight outlet direction, when used with BLF 5.08HC as wire-to-wire application for panel feed-through. The male plugs provide space for labelling and can be coded.

**General ordering data**

Type	SLF 5.08/03/180F SN OR ...	Version	Product data	Packaging
Order No.	<a href="#">1335620000</a>	PCB plug-in connector, male plug, 5.08 mm, Number of poles: 3,	IEC: 400 V / 25.9 A / 0.2 - 2.5 mm <sup>2</sup>	Box
GTIN (EAN)	4050118139365	180°, PUSH IN, Spring connection, Clamping range, max.: 3.31 mm <sup>2</sup> , UL: 300 V / 14 A / AWG 26 - AWG 12		
Qty.	72 pc(s).	Box		
Type	SLF 5.08/03/180F SN BK ...	Version	Product data	Packaging
Order No.	<a href="#">1336180000</a>	PCB plug-in connector, male plug, 5.08 mm, Number of poles: 3,	IEC: 400 V / 25.9 A / 0.2 - 2.5 mm <sup>2</sup>	Box
GTIN (EAN)	4050118140316	180°, PUSH IN, Spring connection, Clamping range, max.: 3.31 mm <sup>2</sup> , UL: 300 V / 14 A / AWG 26 - AWG 12		
Qty.	72 pc(s).	Box		

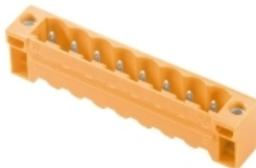
**SL 5.08HC/180F**

Pin headers in glass-fibre-reinforced plastic with straight wire outlet; optimised for wave soldering. The flange variant (F) can be screwed onto the respective counter piece or the circuit board. There is no need for an extra screw to connect the circuit board when the solder flange (LF) version is used. This also protects the solder points from mechanical strain. All pin headers can be manually coded or ordered pre-coded. HC = High Current.

**General ordering data**

Type	SL 5.08HC/03/180F 3.2SN ...	Version	Product data	Packaging
Order No.	<a href="#">1147170000</a>	PCB plug-in connector, male header, Flange, THT solder connection,	IEC: 400 V / 24 A	Box
GTIN (EAN)	4032248930906	5.08 mm, Number of poles: 3, 180°, Solder pin length (l): 3.2 mm,	UL: 300 V / 18.5 A	
Qty.	72 pc(s).	tinned, orange, Box		
Type	SL 5.08HC/03/180F 3.2SN ...	Version	Product data	Packaging
Order No.	<a href="#">1148520000</a>	PCB plug-in connector, male header, Flange, THT solder connection,	IEC: 400 V / 24 A	Box
GTIN (EAN)	4032248932429	5.08 mm, Number of poles: 3, 180°, Solder pin length (l): 3.2 mm,	UL: 300 V / 18.5 A	
Qty.	72 pc(s).	tinned, black, Box		

## OMNIMATE Signal - series BL/SL 5.08 BLDF 5.08/03/180F SN BK BX

**Weidmüller Interface GmbH & Co. KG**  
Klingenbergstraße 26  
D-32758 Detmold  
Germany  
Fon: +49 5231 14-0  
Fax: +49 5231 14-292083  
www.weidmueller.com

# Accessories

## Coding elements



**Only connects what is supposed to be connected: the right connection at the right place.**

Coding elements and locking devices clearly assign connecting elements during the manufacturing process and operation

The coding elements and locking devices are inserted prior to assembly or during the cable assembly phase. The Weidmüller alternative: configure online using the variant configurator to precode prior to delivery.

Incorrect assembly on the circuit board and incorrect plugging of connecting elements is no longer possible. The advantage: no troubleshooting during manufacture and no operational errors by the user.

### General ordering data

Type	BLZ/SL KO BK BX	Version	Product data	Packaging
Order No.	<a href="#">1545710000</a>	PCB plug-in connector, Accessories, Coding element, black, Number		Box
GTIN (EAN)	4008190087142	of poles: 1		
Qty.	50 pc(s).			
Type	BLZ/SL KO OR BX	Version	Product data	Packaging
Order No.	<a href="#">1573010000</a>	PCB plug-in connector, Accessories, Coding element, orange, Number		Box
GTIN (EAN)	4008190048396	of poles: 1		
Qty.	100 pc(s).			

## Slotted screwdriver

Slotted screwdriver with rounded blade SD DIN 5265, ISO 2380/2, output to DIN 5264, ISO 2380/1. ChromTop tip, SoftFinish grip



### General ordering data

Type	SDS 0.6X3.5X200	Version
Order No.	<a href="#">9010110000</a>	Screwdriver, Blade width (B): 3.5 mm, Blade length: 200 mm, Blade thickness (A): 0.6 mm
GTIN (EAN)	4032248300754	
Qty.	1 pc(s).	
Type	SDS 0.6X3.5X100	Version
Order No.	<a href="#">9008330000</a>	Screwdriver, Blade width (B): 3.5 mm, Blade length: 100 mm, Blade thickness (A): 0.6 mm
GTIN (EAN)	4032248056286	
Qty.	1 pc(s).	

**Data sheet****OMNIMATE Signal - series BL/SL 5.08  
BLDF 5.08/03/180F SN BK BX**

**Weidmüller Interface GmbH & Co. KG**  
Klingenbergstraße 26  
D-32758 Detmold  
Germany  
Fon: +49 5231 14-0  
Fax: +49 5231 14-292083  
www.weidmueller.com

**Accessories****Slotted screwdriver**

VDE insulated slot-head screwdriver, SDI DIN 7437, ISO 2380/2, drive output acc. to DIN 5264, ISO 2380/1.  
SoftFinish grip

**General ordering data**

Type	SDIS 0.6X3.5X100	Version
Order No.	<a href="#">9008390000</a>	Screwdriver, Blade width (B): 3.5 mm, Blade length: 100 mm, Blade
GTIN (EAN)	4032248056354	thickness (A): 0.6 mm
Qty.	1 pc(s).	

**Data sheet****OMNIMATE Signal - series BL/SL 5.08**  
**BLDF 5.08/03/180F SN BK BX****Weidmüller Interface GmbH & Co. KG**  
Klingenbergstraße 26  
D-32758 Detmold  
Germany  
Fon: +49 5231 14-0  
Fax: +49 5231 14-292083  
[www.weidmueller.com](http://www.weidmueller.com)**Drawings****Product benefits**

Wide clamping range  
Tool-free wire connection

SHOWN: BLDf 5.08/04/180 G

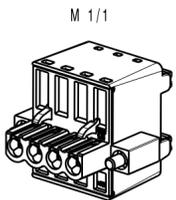
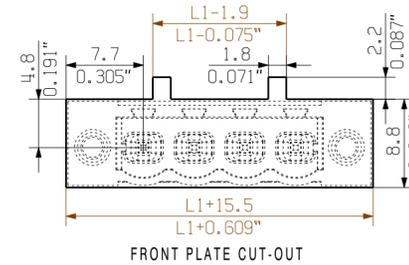
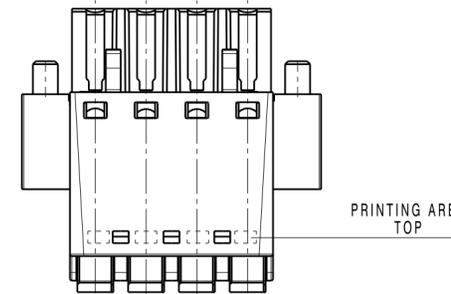
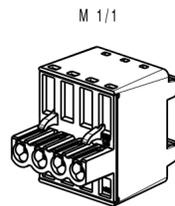
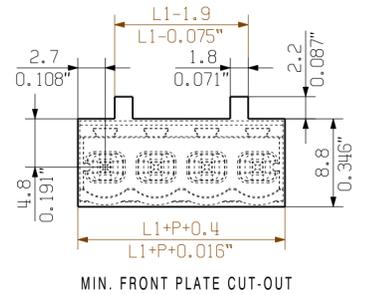
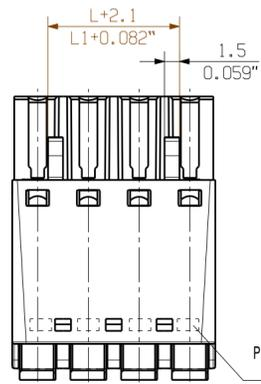
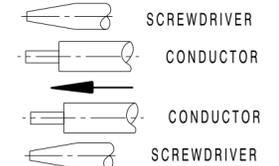
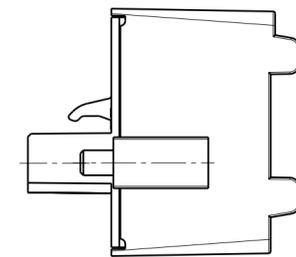
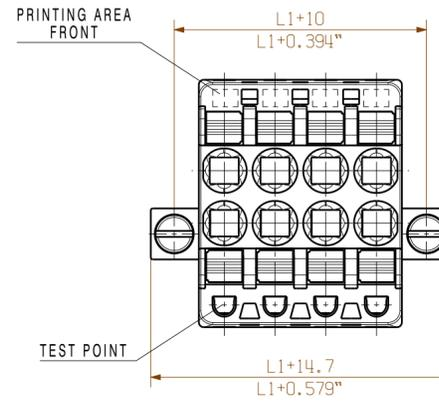
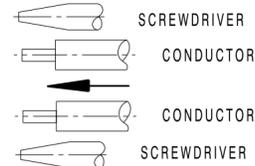
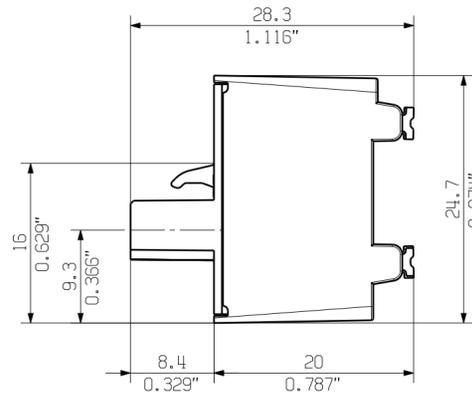
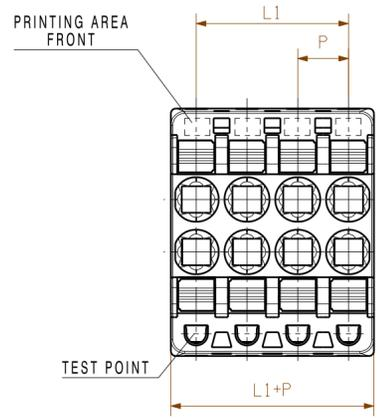

SHOWN: BLDf 5.08/04/180 LR

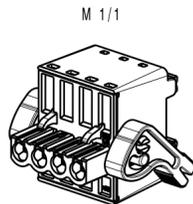
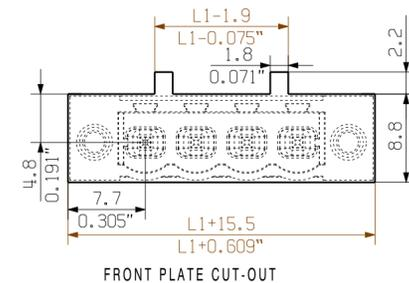
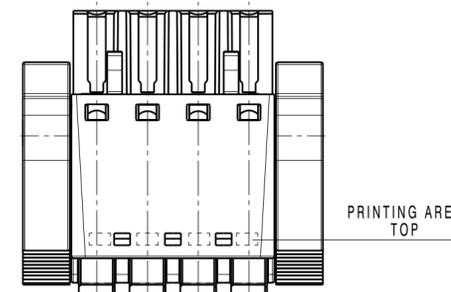
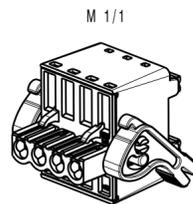
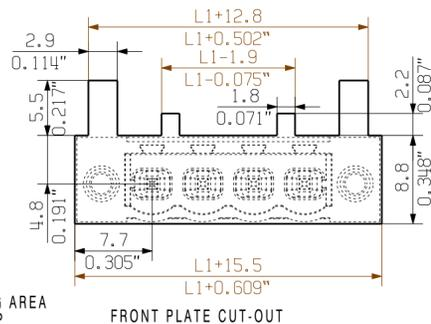
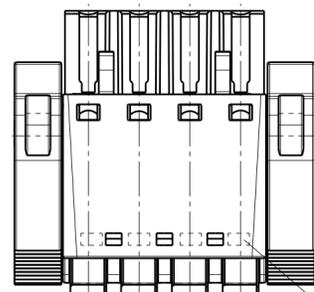
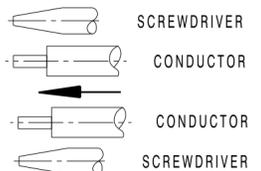
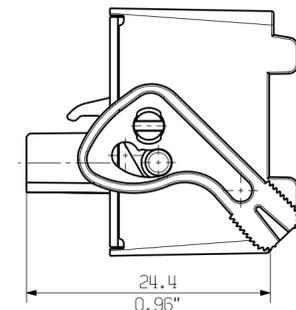
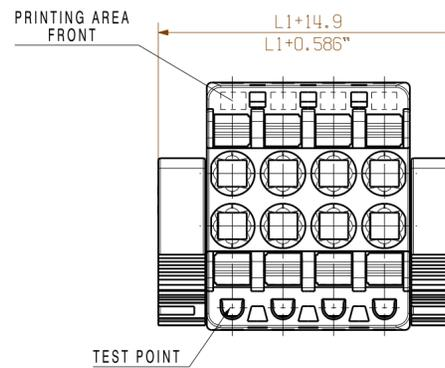
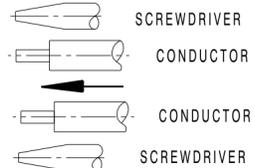
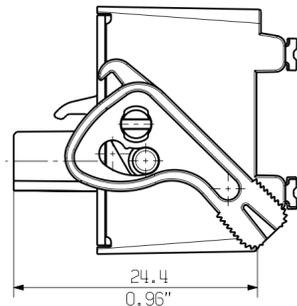
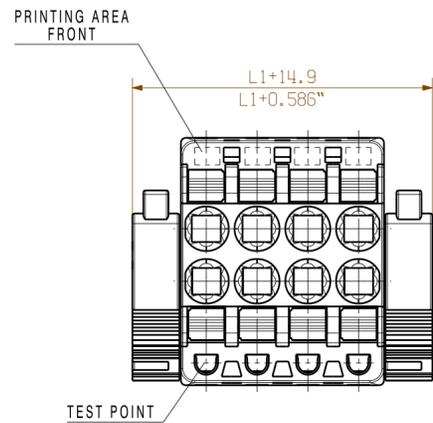

For the mounting of PCBs, it should be noted that the rated data given in the catalogue relates only to the connection elements. The necessary creepage and clearance paths must be observed in connection with the respective applicant in accordance with VDE 0110. The current-carrying capacity and pitch tolerance is to be determined according to DIN IEC 326 part 3 very fine.

Weidmüller connectors are tested to the DIN VDE 0627 standard, and are valid for its field of application. Provided that the connectors are used to the intended purpose, all requirements with respect to the occurring of electrical, mechanical, thermic and corrosive stress will be satisfied.

ALLGEMEINGUELTIGE KUNDENZEICHUNG, AKTUELLER STAND NUR AUF ANFRAGE  
GENERAL CUSTOMER DRAWING, TOPICAL VERSION ONLY IF REQUIRED

GENERAL TOLERANCE:  
DIN ISO 2768-m

EC00002032		Prim PLM Part No.: 002876		Prim ERP Part No.: 1001170000	
First Issue Date 01.03.2010		Max. nos. Modification		<b>47786</b> Drawing no. Issue no. Sheet 02 of 02 sheets	
Scale: 2:1		Size: A2			
Drawings Assembly		Date Name 22.07.2019 Helis, Maria		BLDf 5.08/.../180... BUCHSENLEISTE SOCKET BLOCK Product file: 7379 BLF 5.08 180	
Approved 31.07.2019 Hertel, Suzann		Responsible Hertel, Suzann		POLZAHL n MASS L1 MASS L1 POLES DIM. [mm] DIM. [Inch]	

8	35.56	1.400
7	30.48	1.200
6	25.40	1.000
5	20.32	0.800
4	15.24	0.600
3	10.16	0.400
2	5.08	0.200

P=5.08 RASTER  
PITCH