

Data sheet | Item number: 899-631/309-000

Distribution box; Motion/presence detector; 1 input; 3 outputs; Cod. A, S;
MIDI; black

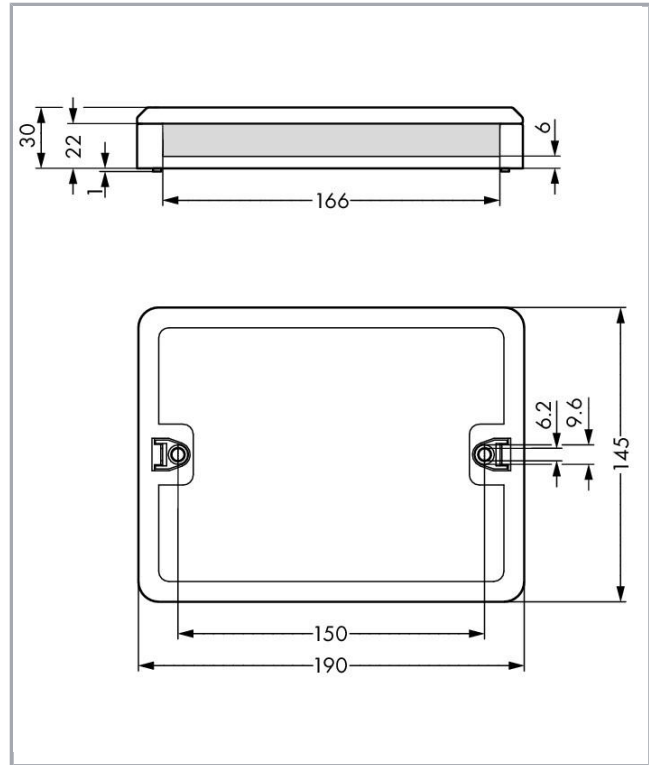

www.wago.com/899-631/309-000

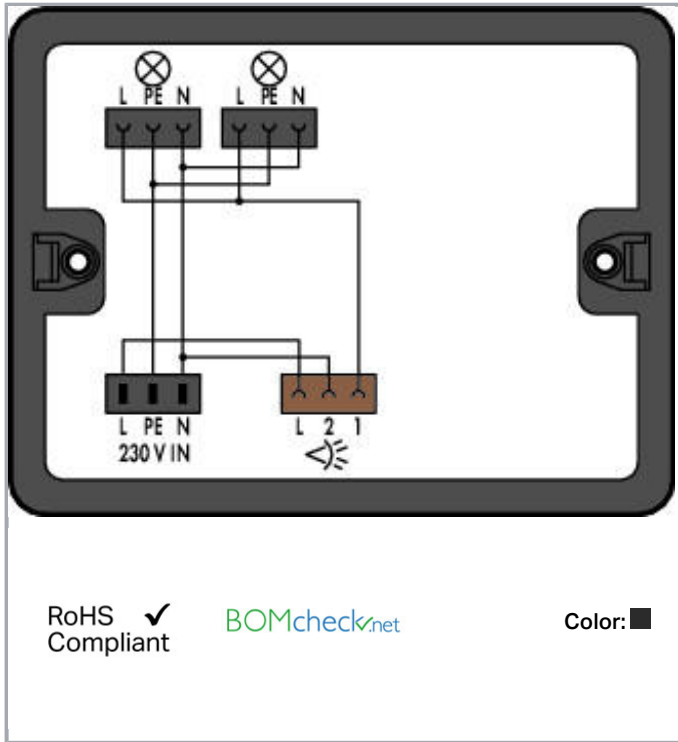

Item description

This WAGOSTA[®] Distribution Box connects to one motion detector and two lights.

Note on mismatching protection:

All WAGOSTA[®] components are 100% protected against mismatching when:

- plugging different numbers of poles
- plugging while rotated 180
- plugging while laterally staggered
- plugging one pole

Data

Electrical data

Note on Contact Resistance

approx. 1 mΩ of contact resistance approx. 0.25 mΩ contact

Subject to changes. Please also observe the further product documentation!

WAGO Kontakttechnik GmbH & Co. KG
Hansastr. 27
32423 Minden
Phone: +49571 887-0 | Fax: +49571 887-169
Email: info.de@wago.com | Web: www.wago.com

Do you have any questions about our products?
We are always happy to take your call at +49 (571) 887-44222.



transition plug/socket

Ratings per IEC/EN 60664-1

Ratings per	IEC/EN 60664-1
Rated voltage (III / 3)	250 V
Rated impulse voltage (III / 3)	4 kV
Rated current	25 A
Legend (ratings)	(III / 3) ≙ Overvoltage category III / Pollution degree 3

Geometrical Data

Width	190 mm / 7.48 inch
Height	30 mm / 1.181 inch
Depth	145 mm / 5.709 inch

Mechanical data

Interne Verdrahtung	4 mm ²
Coding	A
Type of mounting	Wall, screw mount Installation on mounting plate
Protection class	IP20
Note on protection class	Only when mated (these compact connectors are not designed for use in open, easily accessible areas).
Application	General mains applications

Plug connection

Mismating protection	Yes
Locking of plug-in connection	locking lever

Material Data

Color	black
Insulating material	Polyamide 66 (PA 66)
Contact material	Copper or copper alloy (surface-treated)
Weight	335.7 g

Environmental Requirements

Processing temperature	-5 ... +40 °C
------------------------	---------------

Subject to changes. Please also observe the further product documentation!

WAGO Kontakttechnik GmbH & Co. KG
 Hansastr. 27
 32423 Minden
 Phone: +49571 887-0 | Fax: +49571 887-169
 Email: info.de@wago.com | Web: www.wago.com

Do you have any questions about our products?
 We are always happy to take your call at +49 (571) 887-44222.

Continuous operating temperature

-35 ... +85 °C













Note on Continuous Service Temperature

Insulating parts for temperatures ≤ 105 °C

Commercial data

Packaging type	BOX
Country of origin	DE
GTIN	4055143270960
Customs Tariff No.	85366990990

Counterpart

	Item no.770-103 Socket; with strain relief housing; 3-pole; Cod. A; 4,00 mm ² ; black	www.wago.com/770-103
	Item no.770-113 Plug; with strain relief housing; 3-pole; Cod. A; 4,00 mm ² ; black	www.wago.com/770-113
	Item no.770-1373 Plug; 3-pole; Cod. S; 4,00 mm ² ; brown	www.wago.com/770-1373
	Item no.770-203/035-000 Socket; with strain relief housing; 3-pole; Cod. A; 4,00 mm ² ; black	www.wago.com/770-203/035-000
	Item no.770-203 Socket; 3-pole; Cod. A; 4,00 mm ² ; black	www.wago.com/770-203
	Item no.770-213 Plug; 3-pole; Cod. A; 4,00 mm ² ; black	www.wago.com/770-213
	Item no.770-213/035-000 Plug; with strain relief housing; 3-pole; Cod. A; 4,00 mm ² ; black	www.wago.com/770-213/035-000
	Item no.771-9973/006-105 pre-assembled interconnecting cable; Eca; Socket/plug; 3-pole; Cod. S; H05VV-F 3 x 1.5 mm ² ; 1 m; 1,50 mm ² ; brown	www.wago.com/771-9973/006-105
	Item no.771-9973/206-105 pre-assembled connecting cable; Eca; Plug/open-ended; 3-pole; Cod. S; H05VV-F 3 x 1.5 mm ² ; 1 m; 1,50 mm ² ; brown	www.wago.com/771-9973/206-105
	Item no.771-9993/006-101 pre-assembled interconnecting cable; Eca; Socket/plug; 3-pole; Cod. A; H05VV-F 3G 1.5 mm ² ; 1 m; 1,50 mm ² ; black	www.wago.com/771-9993/006-101
	Item no.771-9993/106-101 pre-assembled connecting cable; Eca; Socket/open-ended; 3-pole; Cod. A; H05VV-F 3G 1.5 mm ² ; 1 m; 1,50 mm ² ; black	www.wago.com/771-9993/106-101
	Item no.771-9993/206-101	

Subject to changes. Please also observe the further product documentation!

WAGO Kontakttechnik GmbH & Co. KG

Hansastr. 27

32423 Minden

Phone: +49571 887-0 | Fax: +49571 887-169

Email: info.de@wago.com | Web: www.wago.com

Do you have any questions about our products?

We are always happy to take your call at +49 (571) 887-44222.

pre-assembled connecting cable; Eca; Plug/open-ended; 3-pole; Cod. A; H05VV-F 3G 1.5 mm²; 1 m; 1,50 mm²; black www.wago.com/771-9993/206-101

Compatible products

assembling

Item no.: 770-680
Mounting plate; for distribution boxes

www.wago.com/770-680

Installation Notes

Installation



Securing the mounting plate with WINSTA[®]
Distribution Box to the wall (e.g., via stud gun).

Product family

WINSTA[®] Boxen

WINSTA[®] ist das Steckverbindersystem, das optimal auf die hohen Anforderungen in der Gebäudeinstallation zugeschnitten ist. Es macht die Elektroinstallation steckbar und dadurch schnell, sicher und fehlerfrei. Dies gilt auch in weiteren Anwendungen wie z. B. im Schiffbau, in der Bahntechnik oder in der Industrie.

[Show all products from the family](#)

Subject to changes. Please also observe the further product documentation!