

## Data sheet | Item number: 899-631/305-000

Distribution box; Crossover switching; 1 input; 5 outputs; Cod. A, B, S; MIDI; black

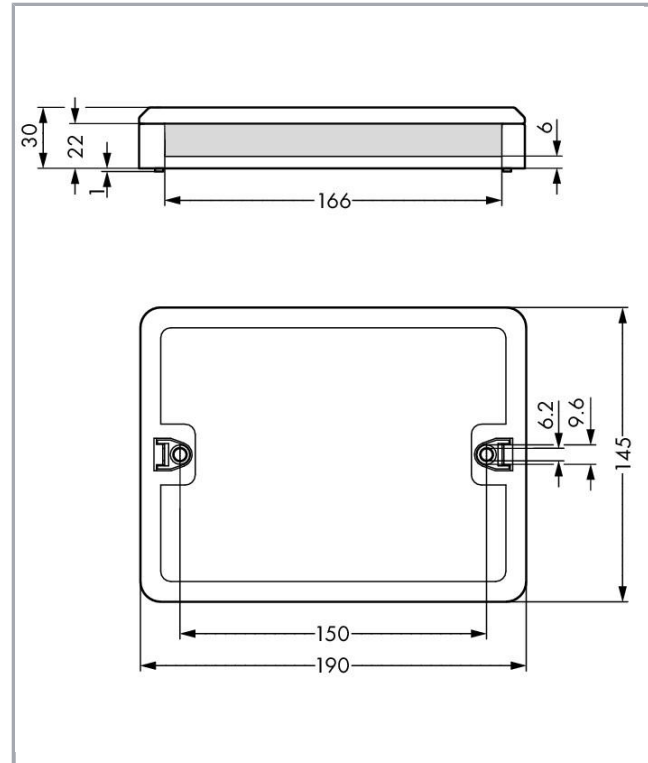

[www.wago.com/899-631/305-000](http://www.wago.com/899-631/305-000)

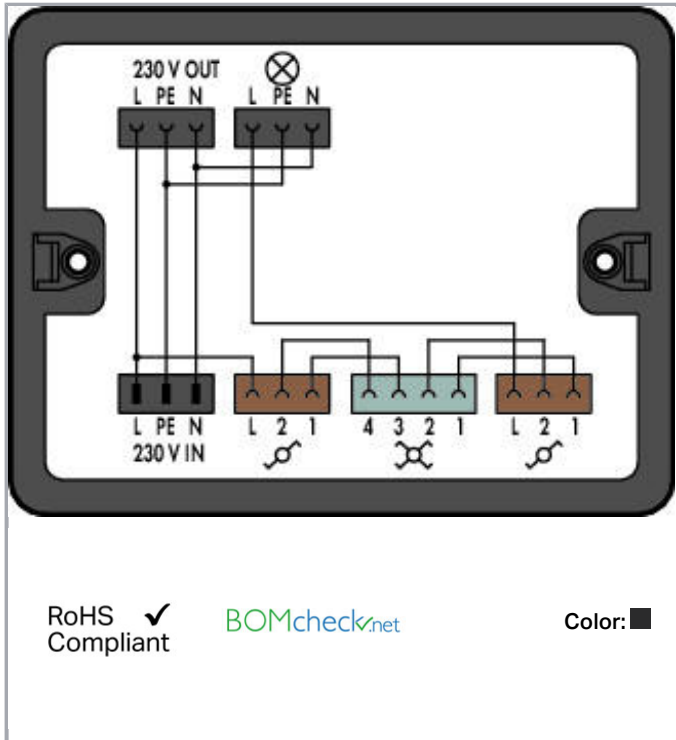

### Item description

This WINSTA<sup>®</sup> Distribution Box features one crossover switch.

#### Note on mismatching protection:

All WINSTA<sup>®</sup> components are 100% protected against mismatching when:

- plugging different numbers of poles
- plugging while rotated 180
- plugging while laterally staggered
- plugging one pole

### Data

#### Electrical data

Note on Contact Resistance

approx. 1 m $\Omega$  of contact resistance approx. 0.25 m $\Omega$  contact

Subject to changes. Please also observe the further product documentation!

WAGO Kontakttechnik GmbH & Co. KG  
Hansastr. 27  
32423 Minden  
Phone: +49571 887-0 | Fax: +49571 887-169  
Email: [info.de@wago.com](mailto:info.de@wago.com) | Web: [www.wago.com](http://www.wago.com)

Do you have any questions about our products?  
We are always happy to take your call at +49 (571) 887-44222.

transition plug/socket

### Ratings per IEC/EN 60664-1

Ratings per	IEC/EN 60664-1
Rated voltage (III / 3)	250 V
Rated impulse voltage (III / 3)	4 kV
Rated current	25 A
Legend (ratings)	(III / 3) ≙ Overvoltage category III / Pollution degree 3

### Geometrical Data

Width	190 mm / 7.48 inch
Height	30 mm / 1.181 inch
Depth	145 mm / 5.709 inch

### Mechanical data

Interne Verdrahtung	4 mm <sup>2</sup>
Coding	A
Type of mounting	Wall, screw mount Installation on mounting plate
Protection class	IP20
Note on protection class	Only when mated (these compact connectors are not designed for use in open, easily accessible areas).
Application	General mains applications

### Plug connection

Mismating protection	Yes
Locking of plug-in connection	locking lever

### Material Data

Color	black
Insulating material	Polyamide 66 (PA 66)
Contact material	Copper or copper alloy (surface-treated)
Weight	359.3 g

### Environmental Requirements

Processing temperature	-5 ... +40 °C
------------------------	---------------

Subject to changes. Please also observe the further product documentation!

Continuous operating temperature

-35 ... +85 °C













Note on Continuous Service Temperature

Insulating parts for temperatures  $\leq 105$  °C

## Commercial data

Packaging type	BOX
Country of origin	DE
GTIN	4055143294393
Customs Tariff No.	85366990990

## Counterpart

	<b>Item no.770-103</b> Socket; with strain relief housing; 3-pole; Cod. A; 4,00 mm <sup>2</sup> ; black	<a href="http://www.wago.com/770-103">www.wago.com/770-103</a>
	<b>Item no.770-113</b> Plug; with strain relief housing; 3-pole; Cod. A; 4,00 mm <sup>2</sup> ; black	<a href="http://www.wago.com/770-113">www.wago.com/770-113</a>
	<b>Item no.770-203</b> Socket; 3-pole; Cod. A; 4,00 mm <sup>2</sup> ; black	<a href="http://www.wago.com/770-203">www.wago.com/770-203</a>
	<b>Item no.770-203/035-000</b> Socket; with strain relief housing; 3-pole; Cod. A; 4,00 mm <sup>2</sup> ; black	<a href="http://www.wago.com/770-203/035-000">www.wago.com/770-203/035-000</a>
	<b>Item no.770-213</b> Plug; 3-pole; Cod. A; 4,00 mm <sup>2</sup> ; black	<a href="http://www.wago.com/770-213">www.wago.com/770-213</a>
	<b>Item no.770-1373</b> Plug; 3-pole; Cod. S; 4,00 mm <sup>2</sup> ; brown	<a href="http://www.wago.com/770-1373">www.wago.com/770-1373</a>
	<b>Item no.770-254</b> Plug; 4-pole; Cod. B; 4,00 mm <sup>2</sup> ; gray	<a href="http://www.wago.com/770-254">www.wago.com/770-254</a>
	<b>Item no.770-213/035-000</b> Plug; with strain relief housing; 3-pole; Cod. A; 4,00 mm <sup>2</sup> ; black	<a href="http://www.wago.com/770-213/035-000">www.wago.com/770-213/035-000</a>
	<b>Item no.771-9973/006-105</b> pre-assembled interconnecting cable; Eca; Socket/plug; 3-pole; Cod. S; H05VV-F 3 x 1.5 mm <sup>2</sup> ; 1 m; 1,50 mm <sup>2</sup> ; brown	<a href="http://www.wago.com/771-9973/006-105">www.wago.com/771-9973/006-105</a>
	<b>Item no.771-9993/006-101</b> pre-assembled interconnecting cable; Eca; Socket/plug; 3-pole; Cod. A; H05VV-F 3G 1.5 mm <sup>2</sup> ; 1 m; 1,50 mm <sup>2</sup> ; black	<a href="http://www.wago.com/771-9993/006-101">www.wago.com/771-9993/006-101</a>
	<b>Item no.771-9993/106-101</b> pre-assembled connecting cable; Eca; Socket/open-ended; 3-pole; Cod. A; H05VV-F 3G 1.5 mm <sup>2</sup> ; 1 m; 1,50 mm <sup>2</sup> ; black	<a href="http://www.wago.com/771-9993/106-101">www.wago.com/771-9993/106-101</a>
	<b>Item no.771-9973/206-105</b>	<a href="http://www.wago.com/771-9973">www.wago.com/771-9973</a>

Subject to changes. Please also observe the further product documentation!

WAGO Kontakttechnik GmbH &amp; Co. KG

Hansastr. 27

32423 Minden

Phone: +49571 887-0 | Fax: +49571 887-169

Email: [info.de@wago.com](mailto:info.de@wago.com) | Web: [www.wago.com](http://www.wago.com)

Do you have any questions about our products?

We are always happy to take your call at +49 (571) 887-44222.

pre-assembled connecting cable; Eca; Plug/open-ended; 3-pole; Cod. S; H05VV-F 3 x 1.5 mm<sup>2</sup>; 1 m; /206-105  
1,50 mm<sup>2</sup>; brown



**Item no.771-9993/206-101**

pre-assembled connecting cable; Eca; Plug/open-ended; 3-pole; Cod. A; H05VV-F 3G 1.5 mm<sup>2</sup>; 1 m;  
1,50 mm<sup>2</sup>; black

[www.wago.com/771-9993/206-101](http://www.wago.com/771-9993/206-101)



**Item no.771-9994/205-103**

pre-assembled connecting cable; Eca; Plug/open-ended; 4-pole; Cod. B; Control cable 4 x 1.0 mm<sup>2</sup>; 1  
m; 1,00 mm<sup>2</sup>; gray

[www.wago.com/771-9994/205-103](http://www.wago.com/771-9994/205-103)



**Item no.771-9994/005-103**

pre-assembled interconnecting cable; Socket/plug; 4-pole; Cod. B; Control cable 4 x 1.0 mm<sup>2</sup>; 1 m;  
1,00 mm<sup>2</sup>; gray

[www.wago.com/771-9994/005-103](http://www.wago.com/771-9994/005-103)

## Compatible products

### assembling

**Item no.: 770-680**

Mounting plate; for distribution boxes

[www.wago.com/770-680](http://www.wago.com/770-680)

## Installation Notes

### Installation



Securing the mounting plate with WINSTA<sup>®</sup>  
Distribution Box to the wall (e.g., via stud gun).

## Product family

### <i>WINSTA</i><sup>®</sup> Boxen

WINSTA<sup>®</sup> ist das Steckverbindersystem, das optimal auf die hohen Anforderungen in der Gebäudeinstallation zugeschnitten ist. Es macht die Elektroinstallation steckbar und dadurch schnell, sicher und fehlerfrei. Dies gilt auch in weiteren Anwendungen wie z. B. im Schiffbau, in der Bahntechnik oder in der Industrie.

[Show all products from the family](#)

Subject to changes. Please also observe the further product documentation!

WAGO Kontakttechnik GmbH & Co. KG

Hansastr. 27

32423 Minden

Phone: +49571 887-0 | Fax: +49571 887-169

Email: [info.de@wago.com](mailto:info.de@wago.com) | Web: [www.wago.com](http://www.wago.com)

Do you have any questions about our products?

We are always happy to take your call at +49 (571) 887-44222.