

## Data sheet | Item number: 891-8995/216-601

pre-assembled connecting cable; Eca; Plug/open-ended; 5-pole; Cod. A;  
H05Z1Z1-F 5G 1.5 mm<sup>2</sup>; 6 m; 1,50 mm<sup>2</sup>; black

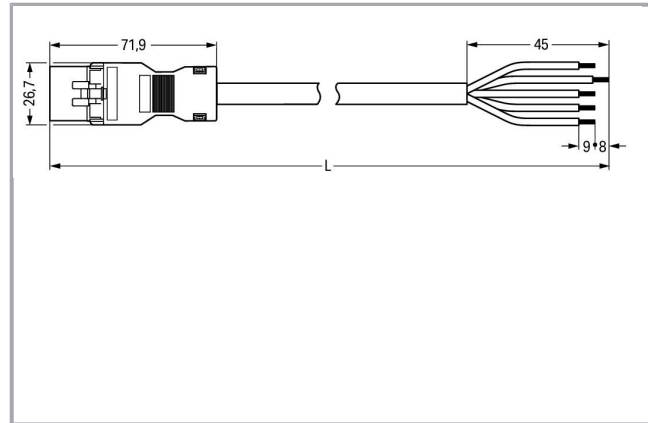

[www.wago.com/891-8995/216-601](http://www.wago.com/891-8995/216-601)

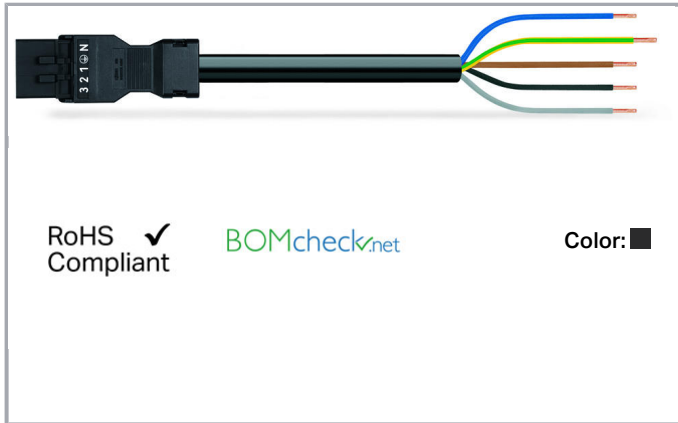

### Item description

- Protected against mismatching and maintenance-free
- Compact design with 4.4 mm pole spacing

### Note:

Cables with a different fire class can be found in the eShop.

### Note on mismatching protection:

All WINSTA<sup>®</sup> components are 100% protected against mismatching when:

- plugging different numbers of poles
- plugging while rotated 180
- plugging while laterally staggered
- plugging one pole

### Safety information 1:

Application note for the U.S. market (USR): Some versions may also be used for current interruption in accordance with the UL certificate in select applications with currents below 5 A and voltages up to 600 V. For further information, please contact your local sales office.

## Data

### Electrical data

Note on Contact Resistance

approx. 1 m $\Omega$  of contact resistance approx. 0.25 m $\Omega$  contact transition plug/socket

Subject to changes. Please also observe the further product documentation!

WAGO Kontakttechnik GmbH & Co. KG  
Hansastr. 27  
32423 Minden  
Phone: +49571 887-0 | Fax: +49571 887-169  
Email: [info.de@wago.com](mailto:info.de@wago.com) | Web: [www.wago.com](http://www.wago.com)

Do you have any questions about our products?  
We are always happy to take your call at +49 (571) 887-44222.



### Ratings per IEC/EN 60664-1

Ratings per	IEC/EN 60664-1
Rated voltage (III / 3)	400 V
Rated impulse voltage (III / 3)	6 kV
Rated current	13 A
Legend (ratings)	(III / 3) ≙ Overvoltage category III / Pollution degree 3

### Approvals per UL 1977

Rated voltage per UL 1977 (factory wiring only)	600 V
Rated current per UL 1977 (factory wiring only)	12 A

### Connection data

Strip length	9 mm / 0.35 inch
No. of poles	5
Total number of potentials	5
Conductor preparation	tip-bonded
Cable diameter	9,3 ... 11,6 mm
Cross section of single conductor	1.5 mm <sup>2</sup>
Strip length	45 mm
Connection type	Plug - Free end

### Geometrical Data

Pin spacing	4,4 mm / 0.173 inch
Total length	6 m

### Mechanical data

Coding	A
Mating force of a plug-in connection	approx. 20 ... 70 N (depending on pole number)
Retention force of a plug-in connection	when locked: > 80N
Unmating force of a plug-in connection	when unlocked: approx. 20 ... 70 N (depending on pole number)
Number of mating cycles	200, without resistive load 100, with resistive load $I_N = 16$ A, tested (1.5mm <sup>2</sup> /AWG 16)
Connection type	Plug - free end

Subject to changes. Please also observe the further product documentation!



Type of cable assembly	Connecting cable
Type of cable	H05Z1Z1-F 5G1.5
Marking	N 1 2 3
Protection class	IP20
Note on protection class	IP40 when mated
Potential marking	N 1 2 3
Application	General mains applications

### Plug connection

Mismating protection	Yes
Locking of plug-in connection	locking lever
Locking lever	no

### Material Data

Color	black
Insulating material	Polyamide 66 (PA 66)
Reaction to fire class per EN 50575	E <sub>ca</sub>
Contact material	Copper or copper alloy (surface-treated)
Fire load	13.52 MJ
Connector color	black
Printing color of mating face	white
Strain relief color	black
Printing color of strain relief	white
Color of sheathed cable	black
Printing color of sheathed cable	white
Halogen-free	Yes
Weight	885.2 g

### Environmental Requirements

Processing temperature	-5 ... +40 °C
Continuous operating temperature	-35 ... +85 °C
Note on Continuous Service Temperature	PVC cable for temperatures ≤ 70 °C (including halogen-free) Insulating parts for temperatures ≤ 105 °C

### Commercial data

Packaging type	not packed
----------------	------------

Subject to changes. Please also observe the further product documentation!

WAGO Kontakttechnik GmbH & Co. KG  
Hansastr. 27  
32423 Minden  
Phone: +49571 887-0 | Fax: +49571 887-169  
Email: [info.de@wago.com](mailto:info.de@wago.com) | Web: [www.wago.com](http://www.wago.com)

Do you have any questions about our products?  
We are always happy to take your call at +49 (571) 887-44222.

Country of origin	PL
GTIN	4055143399777
Customs Tariff No.	85444290900

## Approvals / Certificates





### Country specific Approvals

Logo	Approval	Additional Approval Text	Certificate name
	KEMA/KEUR DEKRA Certification B.V.	EN 61535	2179129.02



## Counterpart

## Compatible products

### Locking lever

	<b>Item no.: 890-101</b> Locking lever; for manual operation; black	<a href="http://www.wago.com/890-101">www.wago.com/890-101</a>
	<b>Item no.: 890-111</b> Locking lever; for flying leads; for tool operation; black	<a href="http://www.wago.com/890-111">www.wago.com/890-111</a>
	<b>Item no.: 890-121</b> Locking lever; for manual operation; white	<a href="http://www.wago.com/890-121">www.wago.com/890-121</a>
	<b>Item no.: 890-131</b> Locking lever; for flying leads; for tool operation; white	<a href="http://www.wago.com/890-131">www.wago.com/890-131</a>

### assembling

	<b>Item no.: 890-310</b> Mounting carrier; 2- to 5-pole; for flying leads; black	<a href="http://www.wago.com/890-310">www.wago.com/890-310</a>
	<b>Item no.: 890-311</b> Mounting carrier; 2- to 5-pole; for flying leads; white	<a href="http://www.wago.com/890-311">www.wago.com/890-311</a>

## Downloads

### CAD/CAE-Data

#### CAE data

WSCAD Universe 891-8995/216-601

Subject to changes. Please also observe the further product documentation!

WAGO Kontakttechnik GmbH & Co. KG  
Hansastr. 27  
32423 Minden  
Phone: +49571 887-0 | Fax: +49571 887-169  
Email: [info.de@wago.com](mailto:info.de@wago.com) | Web: [www.wago.com](http://www.wago.com)

Do you have any questions about our products?  
We are always happy to take your call at +49 (571) 887-44222.



[URL](#)

[Download](#)

---

## Installation Notes

## Product family

*WINSTA*® MINI

[Show all products from the family](#)

Subject to changes. Please also observe the further product documentation!

---

WAGO Kontakttechnik GmbH & Co. KG

Hansastr. 27

32423 Minden

Phone: +49571 887-0 | Fax: +49571 887-169

Email: [info.de@wago.com](mailto:info.de@wago.com) | Web: [www.wago.com](http://www.wago.com)

Do you have any questions about our products?

We are always happy to take your call at +49 (571) 887-44222.