

Data sheet | Item number: 891-8985/206-102

pre-assembled connecting cable; Eca; Plug/open-ended; 5-pole; Cod. I;
H05VV-F 5G 1.5 mm²; 1 m; 1,50 mm²; blue

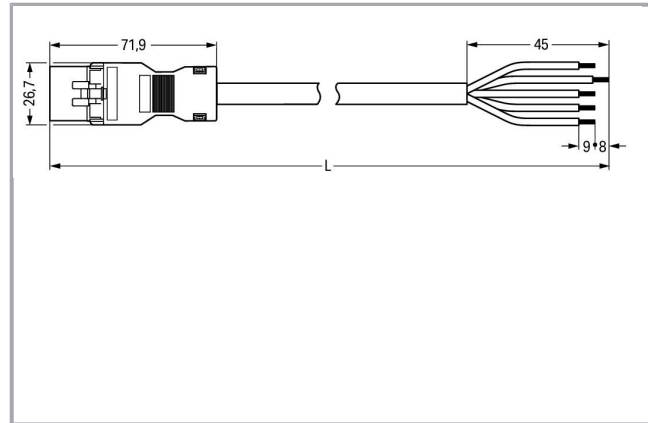

www.wago.com/891-8985/206-102

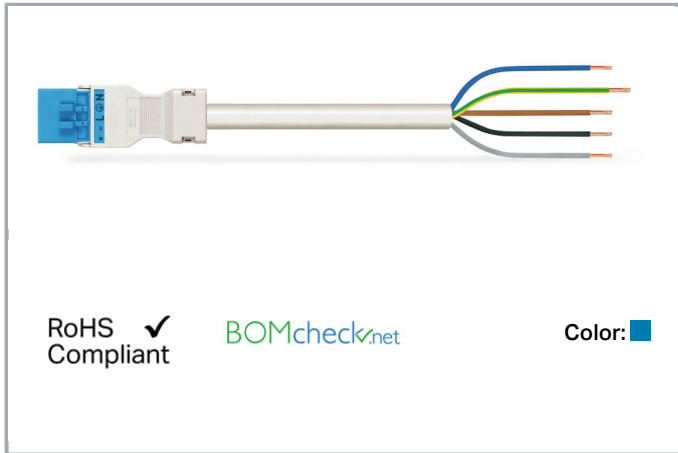

Item description

- Protected against mismatching and maintenance-free
- Compact design with 4.4 mm pole spacing

Note:

Cables with a different fire class can be found in the eShop.

Note on mismatching protection:

All WINSTA[®] components are 100% protected against mismatching when:

- plugging different numbers of poles
- plugging while rotated 180
- plugging while laterally staggered
- plugging one pole

Safety information 1:

Application note for the U.S. market (USR): Some versions may also be used for current interruption in accordance with the UL certificate in select applications with currents below 5 A and voltages up to 600 V. For further information, please contact your local sales office.

Data

Electrical data

Note on Contact Resistance

approx. 1 mΩ of contact resistance approx. 0.25 mΩ contact transition plug/socket

Subject to changes. Please also observe the further product documentation!

WAGO Kontakttechnik GmbH & Co. KG
Hansastr. 27
32423 Minden
Phone: +49571 887-0 | Fax: +49571 887-169
Email: info.de@wago.com | Web: www.wago.com

Do you have any questions about our products?
We are always happy to take your call at +49 (571) 887-44222.

Ratings per IEC/EN 60664-1

Ratings per	IEC/EN 60664-1
Rated voltage (III / 3)	400 V
Rated impulse voltage (III / 3)	6 kV
Rated current	16 A
Legend (ratings)	(III / 3) $\hat{=}$ Overvoltage category III / Pollution degree 3

Approvals per UL 1977

Rated voltage per UL 1977 (factory wiring only)	600 V
Rated current per UL 1977 (factory wiring only)	12 A

Connection data

Strip length	9 mm / 0.35 inch
No. of poles	5
Total number of potentials	5
Ground function	with preceding ground contact
Conductor preparation	tip-bonded
Cable diameter	9,3 ... 11,6 mm
Cross section of single conductor	1.5 mm ²
Strip length	45 mm
Connection type	Plug - Free end

Geometrical Data

Pin spacing	4,4 mm / 0.173 inch
Total length	1 m

Mechanical data

Technologie	DALI
Coding	I
Mating force of a plug-in connection	approx. 20 ... 70 N (depending on pole number)
Retention force of a plug-in connection	when locked: > 80N
Unmating force of a plug-in connection	when unlocked: approx. 20 ... 70 N (depending on pole number)
Number of mating cycles	200, without resistive load 100, with resistive load $I_N = 16$ A, tested (1.5mm ² /AWG 16)

Subject to changes. Please also observe the further product documentation!



Connection type	Plug - free end
Type of cable assembly	Connecting cable
Type of cable	H05VV-F 5G1.5
Marking	N L - +
Protection class	IP20
Note on protection class	IP40 when mated
Potential marking	N L - +
Application	Lighting management

Plug connection

Mismating protection	Yes
Locking of plug-in connection	locking lever
Locking lever	no

Material Data

Color	blue
Insulating material	Polyamide 66 (PA 66)
Reaction to fire class per EN 50575	E _{ca}
Contact material	Copper or copper alloy (surface-treated)
Fire load	3.036 MJ
Connector color	blue
Printing color of mating face	black
Strain relief color	white
Printing color of strain relief	black
Color of sheathed cable	white
Printing color of sheathed cable	black
Sheath material	PVC
Weight	175.9 g

Environmental Requirements

Processing temperature	-5 ... +40 °C
Continuous operating temperature	-35 ... +85 °C
Note on Continuous Service Temperature	PVC cable for temperatures ≤ 70 °C (including halogen-free) Insulating parts for temperatures ≤ 105 °C

Subject to changes. Please also observe the further product documentation!

WAGO Kontakttechnik GmbH & Co. KG
 Hansastr. 27
 32423 Minden
 Phone: +49571 887-0 | Fax: +49571 887-169
 Email: info.de@wago.com | Web: www.wago.com

Do you have any questions about our products?
 We are always happy to take your call at +49 (571) 887-44222.

Commercial data

Packaging type	not packed
Country of origin	PL
GTIN	4055143398572
Customs Tariff No.	85444290900

Approvals / Certificates



Country specific Approvals

Logo	Approval	Additional Approval Text	Certificate name
	KEMA/KEUR DEKRA Certification B.V.	EN 61535	2179129.02



Counterpart

Compatible products

Locking lever

	Item no.: 890-101 Locking lever; for manual operation; black	www.wago.com/890-101
	Item no.: 890-111 Locking lever; for flying leads; for tool operation; black	www.wago.com/890-111
	Item no.: 890-121 Locking lever; for manual operation; white	www.wago.com/890-121
	Item no.: 890-131 Locking lever; for flying leads; for tool operation; white	www.wago.com/890-131

assembling

	Item no.: 890-310 Mounting carrier; 2- to 5-pole; for flying leads; black	www.wago.com/890-310
	Item no.: 890-311 Mounting carrier; 2- to 5-pole; for flying leads; white	www.wago.com/890-311

Subject to changes. Please also observe the further product documentation!



Downloads

CAD/CAE-Data

CAE data

WSCAD Universe 891-8985/206-102

URL

Download

Installation Notes

Product family

WINSTA® MINI

[Show all products from the family](#)

Subject to changes. Please also observe the further product documentation!

WAGO Kontakttechnik GmbH & Co. KG

Hansastr. 27

32423 Minden

Phone: +49571 887-0 | Fax: +49571 887-169

Email: info.de@wago.com | Web: www.wago.com

Do you have any questions about our products?

We are always happy to take your call at +49 (571) 887-44222.