

### Item description

- Protected against mismatching and maintenance-free
- Push-in CAGE CLAMP® spring pressure connection technology allows solid conductors to be simply pushed into a unit
- Compact design with 4.4 mm pole spacing
- Components can be clearly printed on and color-coded to meet custom requirements
- When assembled, the installation connectors complies with IP40 and are suitable for easily accessible areas

Subject to changes. Please also observe the further product documentation!

**Note:**

All connectors for mounted installations (snap-in versions for lighting fixtures or devices, all types of PCB and distribution connectors) are factory-equipped with locking levers to ensure plugs and sockets are securely locked. Additional locking levers are only required for flying leads (plug /socket).

**Note on mismatching protection:**

All WINSTA<sup>®</sup> components are 100% protected against mismatching when:

- a.) plugging different numbers of poles
- b.) plugging while rotated 180
- c.) plugging while laterally staggered
- d.) plugging one pole

**Safety information 1:**

Application note for the U.S. market (USR): Some versions may also be used for current interruption in accordance with the UL certificate in select applications with currents below 5 A and voltages up to 600 V. For further information, please contact your local sales office.

**Data****Electrical data**

Note on Contact Resistance	approx. 1 mΩ of contact resistance approx. 0.25 mΩ contact transition plug/socket
----------------------------	---

**Ratings per IEC/EN 60664-1**

Ratings per	IEC/EN 60664-1
Rated voltage (III / 3)	400 V
Rated impulse voltage (III / 3)	6 kV
Rated current	16 A
Note on rated current	13 A for 3-pole load 10 A for 4- and 5-pole load
Legend (ratings)	(III / 3) ≙ Overvoltage category III / Pollution degree 3

**Approvals per UL 1977**

Rated voltage per UL 1977 (factory wiring only)	600 V
Rated current per UL 1977 (factory wiring only)	12 A

**Connection data**

Connection technology	Push-in CAGE CLAMP <sup>®</sup>
Actuation type	Operating tool Push-in
Nominal cross section	1,5 mm <sup>2</sup>
Solid conductor	0,25 ... 1,5 mm <sup>2</sup> / 22 ... 16 AWG
Solid conductor, push-in termination	0,75 ... 1,5 mm <sup>2</sup> / 20 ... 16 AWG

Subject to changes. Please also observe the further product documentation!

WAGO Kontakttechnik GmbH & Co. KG  
 Hansastr. 27  
 32423 Minden  
 Phone: +49571 887-0 | Fax: +49571 887-169  
 Email: [info.de@wago.com](mailto:info.de@wago.com) | Web: [www.wago.com](http://www.wago.com)

Do you have any questions about our products?  
 We are always happy to take your call at +49 (571) 887-44222.



Stranded conductor	0,25 ... 1 mm <sup>2</sup> / 22 ... 18 AWG
Fine-stranded conductor	0,25 ... 1,5 mm <sup>2</sup> / 22 ... 16 AWG
Fine-stranded conductor with ferrule with plastic collar	0,25 ... 0,75 mm <sup>2</sup> / 22 ... 20 AWG
Fine-stranded conductor with ferrule without plastic collar	0,25 ... 0,75 mm <sup>2</sup> / 22 ... 20 AWG
Fine-stranded conductor with ferrule, push-in termination, from	0,75 mm <sup>2</sup> / 20 AWG
Strip length	9 mm / 0.35 inch
Note (strip length)	see also packaging or instructions
No. of poles	5
Total number of connection points	5
Total number of potentials	5
Conductor entry direction to mating direction	0°

### Geometrical Data

Pin spacing	4,4 mm / 0.173 inch
Width	35,5 mm / 1.398 inch
Height	17,5 mm / 0.689 inch
Depth	39,85 mm / 1.569 inch

### Mechanical data

Coding	B
Mating force of a plug-in connection	approx. 20 ... 70 N (depending on pole number)
Retention force of a plug-in connection	Locked: > 80 N
Unmating force of a plug-in connection	Unlocked: approx. 20 ... 70 N (depending on pole number)
Number of mating cycles	200, without resistive load 100, with resistive load $I_N = 16$ A, tested (1.5 mm <sup>2</sup> /16 AWG)
Gehäuseblechstärke	0,5 ... 2 mm / 0.02 ... 0.079 inch
Mounting type	Snap-in
Marking	N L I- I+
Protection class	IP40
Potential marking	N L I- I+

### Plug connection

Contact type (pluggable connector)	Female connector/socket
Connector connection type	for conductor

Subject to changes. Please also observe the further product documentation!



Mismating protection	Yes
Locking of plug-in connection	locking lever
Locking lever	yes

### Material Data

Color	pink
Insulating material	Polyamide 66 (PA 66)
Clamping spring material	Chrome nickel spring steel (CrNi)
Contact material	Copper or copper alloy (surface-treated)
Weight	9 g

### Environmental Requirements

Processing temperature	-5 ... +40 °C
Continuous operating temperature	-35 ... +85 °C
Note on Continuous Service Temperature	Insulating parts for temperatures ≤ 105 °C

### Commercial data

Packaging type	BOX
Country of origin	PL
GTIN	4055143428088
Customs Tariff No.	85366990990

### Approvals / Certificates

#### Country specific Approvals

Logo	Approval	Additional Approval Text	Certificate name
	<b>CB</b> DEKRA Certification B.V.	EN 61984	NL-52879
	<b>CB</b> DEKRA Certification B.V.	EN 61984	71- 100413

#### Ship Approvals

Logo	Approval	Additional Approval Text	Certificate name
	<b>LR</b> Lloyds Register	EN 61535	08/20047 (E2)

Subject to changes. Please also observe the further product documentation!



## Counterpart



Item no.890-295/080-000  
Plug; 5-pole; 1,50 mm<sup>2</sup>; pink

[www.wago.com/890-295/080-000](http://www.wago.com/890-295/080-000)

## Compatible products

### tools



Item no.: 210-719  
Operating tool; Blade: 2.5 x 0.4 mm; with a partially insulated shaft

[www.wago.com/210-719](http://www.wago.com/210-719)

Item no.: 890-385  
Operating tool; 5-way; green

[www.wago.com/890-385](http://www.wago.com/890-385)

### protection

Item no.: 770-643  
Lockout cap; 3-pole; for cutouts; Plastic; black

[www.wago.com/770-643](http://www.wago.com/770-643)

Item no.: 770-693  
Lockout cap; 3-pole; for cutouts; Plastic; white

[www.wago.com/770-693](http://www.wago.com/770-693)

## Downloads

### CAD/CAE-Data

#### CAD data

2D/3D Models 890-785/080-000

[URL](#)

[Download](#)

#### CAE data

EPLAN Data Portal 890-785/080-000

[URL](#)

[Download](#)

WSCAD Universe 890-785/080-000

[URL](#)

[Download](#)

## Installation Notes

Subject to changes. Please also observe the further product documentation!

WAGO Kontakttechnik GmbH & Co. KG  
Hansastr. 27  
32423 Minden  
Phone: +49571 887-0 | Fax: +49571 887-169  
Email: [info.de@wago.com](mailto:info.de@wago.com) | Web: [www.wago.com](http://www.wago.com)

Do you have any questions about our products?  
We are always happy to take your call at +49 (571) 887-44222.

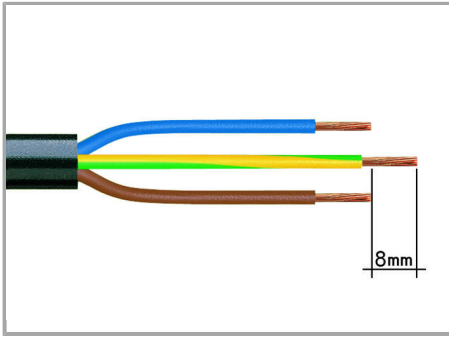

1. Strip length, outer insulation = 30 mm (2-pole), 37 mm (3-pole), 45 mm (4- and 5-pole)

2. Strip length = 9 mm

3. Extended ground conductor = 8 mm

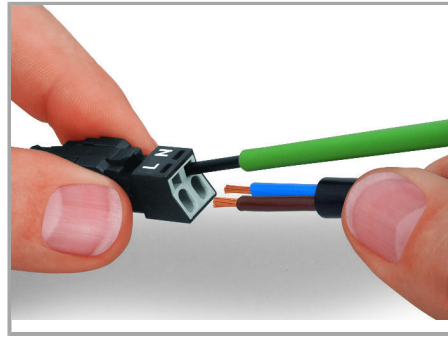

To terminate fine-stranded conductors, open the clamping unit via screwdriver (2.5 mm blade width) and insert a stripped conductor until it hits backstop. Terminate solid conductors by simply pushing them in.

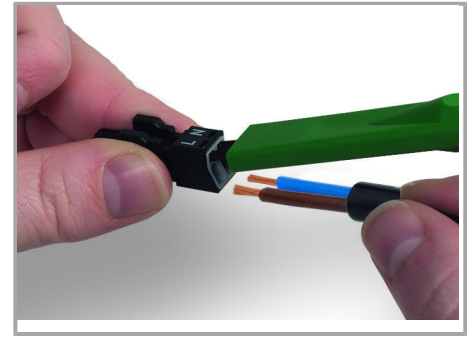

To terminate fine-stranded conductors, open clamping units via operating tool (890-382) and insert stripped conductors until they hit backstop.

Terminate solid conductors by simply pushing them in.

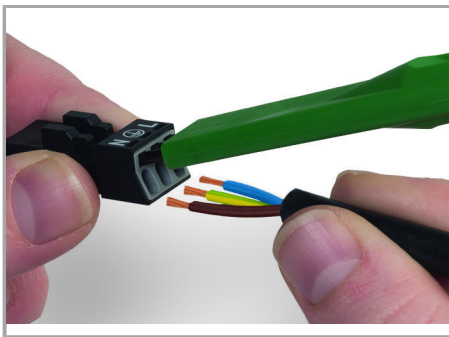

To terminate fine-stranded conductors, open clamping units via operating tool (890-383) and insert stripped conductors until they hit backstop.

Terminate solid conductors by simply pushing them in.

#### Mismatching protection

Subject to changes. Please also observe the further product documentation!

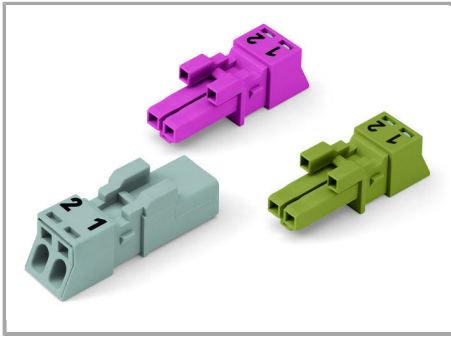

B-coded connectors with different colors can be plugged together.

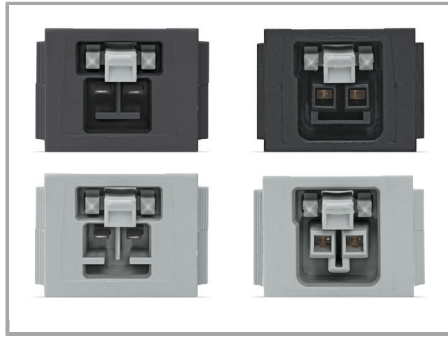

B-coded connectors (shown in gray) not only differ in color, but also in their design, making them incompatible with other coded connectors.



**Important note:**

Different colors and/or pole marking are used for circuit identification.

Only connectors of the same color and same pole marking must be plugged together.

**Product family**

[\*WINSTA\*® MINI special](#)

[Show all products from the family](#)

Subject to changes. Please also observe the further product documentation!