

Data sheet | Item number: 890-686

h-distribution connector; 3-pole; Cod. A; 1 input; 2 outputs; outputs on one side; 3 locking levers; for flying leads; white

www.wago.com/890-686

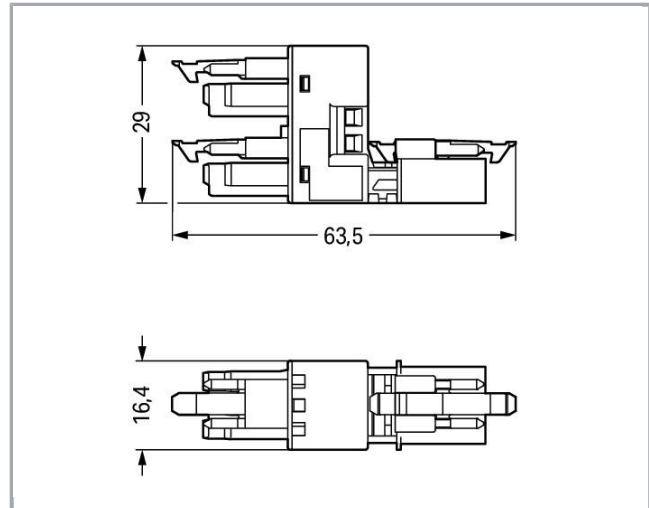

Item description

- Protected against mismatching and maintenance-free
- Compact design with 4.4 mm pole spacing

Note:

All connectors for mounted installations (snap-in versions for lighting fixtures or devices, all types of PCB and distribution connectors) are factory-equipped with locking levers to ensure plugs and sockets are securely locked. Additional locking levers are only required for flying leads (plug /socket).

Note on mismatching protection:

All WINSTA[®] components are 100% protected against mismatching when:
a.) plugging different numbers of poles

Subject to changes. Please also observe the further product documentation!

WAGO Kontakttechnik GmbH & Co. KG
Hansastr. 27
32423 Minden
Phone: +49571 887-0 | Fax: +49571 887-169
Email: info.de@wago.com | Web: www.wago.com

Do you have any questions about our products?
We are always happy to take your call at +49 (571) 887-44222.



- b.) plugging while rotated 180
- c.) plugging while laterally staggered
- d.) plugging one pole

Safety information 1:

Application note for the U.S. market (USR): Some versions may also be used for current interruption in accordance with the UL certificate in select applications with currents below 5 A and voltages up to 600 V. For further information, please contact your local sales office.

Data**Electrical data**

Note on Contact Resistance	approx. 1 mΩ of contact resistance approx. 0.25 mΩ contact transition plug/socket
----------------------------	---

Ratings per IEC/EN 60664-1

Ratings per	IEC/EN 60664-1
Rated voltage (III / 3)	250 V
Rated impulse voltage (III / 3)	4 kV
Rated current	16 A
Legend (ratings)	(III / 3) ≙ Overvoltage category III / Pollution degree 3

Approvals per UL 1977

Rated voltage per UL 1977 (factory wiring only)	600 V
Rated current per UL 1977 (factory wiring only)	14 A

Connection data

No. of poles	3
Total number of potentials	3
Ground function	with preceding ground contact

Geometrical Data

Pin spacing	4,4 mm / 0.173 inch
Width	16,4 mm / 0.646 inch
Height	29 mm / 1.142 inch
Depth	63,5 mm / 2.5 inch

Mechanical data

Coding	A
Mating force of a plug-in connection	approx. 20 ... 70 N (depending on pole number)

Subject to changes. Please also observe the further product documentation!



Retention force of a plug-in connection	When locked: > 80 N
Unmating force of a plug-in connection	when unlocked: approx. 20 ... 70 N (depending on pole number)
Number of mating cycles	200, without resistive load 100, with resistive load $I_N = 16$ A, tested (1.5mm ² /AWG 16)
Type of distribution connector	h-distribution connector (unidirectional)
Marking	L N
Protection class	IP20
Note on protection class	IP40 when mated
Potential marking	L N
Application	General mains applications
Suitable	for flying leads

Plug connection

Contact type (pluggable connector)	Socket/plug
Mismating protection	Yes
Locking of plug-in connection	locking lever
Locking lever	yes

Material Data

Color	white
Insulating material	Polyamide 66 (PA 66)
Contact material	Copper or copper alloy (surface-treated)
Fire load	0.248 MJ
Weight	13.7 g

Environmental Requirements

Processing temperature	-5 ... +40 °C
Continuous operating temperature	-35 ... +85 °C
Note on Continuous Service Temperature	Insulating parts for temperatures ≤ 105 °C

Commercial data

Product Group	20 (WINSTA)
Packaging type	BOX
Country of origin	DE

Subject to changes. Please also observe the further product documentation!

WAGO Kontakttechnik GmbH & Co. KG
 Hansastr. 27
 32423 Minden
 Phone: +49571 887-0 | Fax: +49571 887-169
 Email: info.de@wago.com | Web: www.wago.com

Do you have any questions about our products?
 We are always happy to take your call at +49 (571) 887-44222.



GTIN	4045454404468
Customs Tariff No.	85366990990

Approvals / Certificates

Country specific Approvals

Logo	Approval	Additional Approval Text	Certificate name
	CCA DEKRA Certification B.V.	EN 61535	71-102984
	CCA DEKRA Certification B.V.	IEC 61535	NL-49482

Ship Approvals

Logo	Approval	Additional Approval Text	Certificate name
	ABS American Bureau of Shipping	Steel Vessel Rules	19-HG1869855-PDA
	DNV GL Det Norske Veritas, Germanischer Lloyd	-	TAE00001Z6
	LR Lloyds Register	EN 61535	08/20047 (E2)

UL-Approvals

Logo	Approval	Additional Approval Text	Certificate name
	cURus Underwriters Laboratories Inc.	UL 1977	E45171

Counterpart



Item no.890-123
Socket; with strain relief housing; 3-pole; Cod. A; 1,50 mm²; white

www.wago.com/890-123

Subject to changes. Please also observe the further product documentation!



Item no.890-133
Plug; with strain relief housing; 3-pole; 1,50 mm²; white

www.wago.com/890-133



Item no.890-223
Socket; 3-pole; Cod. A; 1,50 mm²; white

www.wago.com/890-223



Item no.890-233
Plug; 3-pole; 1,50 mm²; white

www.wago.com/890-233



Item no.891-8993/005-102
pre-assembled interconnecting cable; Eca; Socket/plug; 3-pole; Cod. A; 1 m; 1,00 mm²; white

www.wago.com/891-8993/005-102



Item no.891-8993/105-102
pre-assembled connecting cable; Eca; Socket/open-ended; 3-pole; Cod. A; 1 m; 1,00 mm²; white

www.wago.com/891-8993/105-102



Item no.891-8993/205-102
pre-assembled connecting cable; Eca; Plug/open-ended; 3-pole; Cod. A; 1 m; 1,00 mm²; white

www.wago.com/891-8993/205-102

Compatible products

assembling

Item no.: 890-623
Mounting plate; 3-pole; for distribution connectors; Plastic; black

www.wago.com/890-623

Item no.: 890-673
Mounting plate; 3-pole; for distribution connectors; Plastic; white

www.wago.com/890-673

Downloads

CAD/CAE-Data

CAD data

2D/3D Models 890-686	URL	Download

CAE data

EPLAN Data Portal 890-686	URL	Download

WSCAD Universe 890-686	URL	Download

Installation Notes

Installation

Subject to changes. Please also observe the further product documentation!

WAGO Kontakttechnik GmbH & Co. KG
Hansastr. 27
32423 Minden
Phone: +49571 887-0 | Fax: +49571 887-169
Email: info.de@wago.com | Web: www.wago.com

Do you have any questions about our products?
We are always happy to take your call at +49 (571) 887-44222.

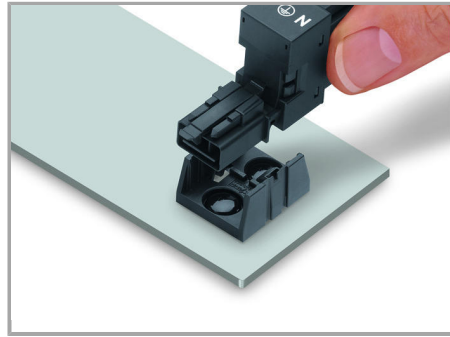

Secure the mounting plate via pins.

Product family

WINSTA® MINI

[Show all products from the family](#)

Subject to changes. Please also observe the further product documentation!