

Item description

- Protected against mismatching and maintenance-free
- Push-in CAGE CLAMP® spring pressure connection technology allows solid conductors to be simply pushed into a unit
- Compact design with 4.4 mm pole spacing
- When assembled, the installation connectors complies with IP40 and are suitable for easily accessible areas

Note:

All connectors for mounted installations (snap-in versions for lighting fixtures or devices, all types of PCB and distribution connectors) are factory-equipped with locking levers to ensure plugs and sockets are securely locked. Additional locking levers are only required for flying leads (plug /socket).

Note on mismatching protection:

All WINSTA® components are 100% protected against mismatching when:

- a.) plugging different numbers of poles
- b.) plugging while rotated 180
- c.) plugging while laterally staggered
- d.) plugging one pole

Safety information 1:

Application note for the U.S. market (USR): Some versions may also be used for current interruption in accordance with the UL certificate in select applications with currents below 5 A and voltages up to 600 V. For further information, please contact your local sales office.

Subject to changes. Please also observe the further product documentation!



Data

Electrical data

Note on Contact Resistance	approx. 1 mΩ of contact resistance approx. 0.25 mΩ contact transition plug/socket
----------------------------	---

Ratings per IEC/EN 60664-1

Ratings per	IEC/EN 60664-1
Rated voltage (III / 3)	400 V
Rated impulse voltage (III / 3)	6 kV
Rated current	16 A
Legend (ratings)	(III / 3) ≙ Overvoltage category III / Pollution degree 3

Approvals per UL 1977

Rated voltage per UL 1977 (factory wiring only)	600 V
Rated current per UL 1977 (factory wiring only)	12 A

Connection data

Connection technology	Push-in CAGE CLAMP®
Actuation type	Operating tool Push-in
Nominal cross section	1,5 mm ²
Solid conductor	0,25 ... 1,5 mm ² / 22 ... 16 AWG
Solid conductor, push-in termination	0,75 ... 1,5 mm ² / 20 ... 16 AWG
Stranded conductor	0,25 ... 1 mm ² / 22 ... 18 AWG
Fine-stranded conductor	0,25 ... 1,5 mm ² / 22 ... 16 AWG
Fine-stranded conductor with ferrule with plastic collar	0,25 ... 0,75 mm ² / 22 ... 20 AWG
Fine-stranded conductor with ferrule without plastic collar	0,25 ... 0,75 mm ² / 22 ... 20 AWG
Fine-stranded conductor with ferrule, push-in termination, from	0,75 mm ² / 20 AWG
Strip length	9 mm / 0.35 inch
Note (strip length)	see also packaging or instructions
No. of poles	5
Total number of connection points	5
Total number of potentials	5
Ground function	with preceding ground contact
Conductor entry direction to mating direction	0°

Subject to changes. Please also observe the further product documentation!

WAGO Kontakttechnik GmbH & Co. KG
 Hansastr. 27
 32423 Minden
 Phone: +49571 887-0 | Fax: +49571 887-169
 Email: info.de@wago.com | Web: www.wago.com

Do you have any questions about our products?
 We are always happy to take your call at +49 (571) 887-44222.



Geometrical Data

Pin spacing	4,4 mm / 0.173 inch
Width	23,6 mm / 0.929 inch
Height	11,7 mm / 0.461 inch
Depth	34,1 mm / 1.343 inch

Mechanical data

Technologie	DALI
Coding	I
Mating force of a plug-in connection	approx. 20 ... 70 N (depending on pole number)
Retention force of a plug-in connection	Locked: > 80 N
Unmating force of a plug-in connection	Unlocked: approx. 20 ... 70 N (depending on pole number)
Number of mating cycles	200, without resistive load 100, with resistive load $I_N = 16$ A, tested (1.5 mm ² /AWG 16)
Marking	N L - +
Protection class	IP20
Note on protection class	IP40 when mated with strain relief housing
Potential marking	N L - +
Application	Lighting management

Plug connection

Contact type (pluggable connector)	Male connector/plug
Connector connection type	for conductor
Mismating protection	Yes
Locking of plug-in connection	locking lever
Locking lever	no

Material Data

Color	blue
Insulating material	Polyamide 66 (PA 66)
Clamping spring material	Chrome nickel spring steel (CrNi)
Contact material	Copper or copper alloy (surface-treated)
Fire load	0.12 MJ

Subject to changes. Please also observe the further product documentation!

WAGO Kontakttechnik GmbH & Co. KG
 Hansastr. 27
 32423 Minden
 Phone: +49571 887-0 | Fax: +49571 887-169
 Email: info.de@wago.com | Web: www.wago.com

Do you have any questions about our products?
 We are always happy to take your call at +49 (571) 887-44222.

Weight	5.7 g
--------	-------

Environmental Requirements

Processing temperature	-5 ... +40 °C
Continuous operating temperature	-35 ... +85 °C
Note on Continuous Service Temperature	Insulating parts for temperatures ≤ 105 °C

Commercial data



Product Group	20 (WINSTA)
Packaging type	BOX
Country of origin	PL
GTIN	4055143548601
Customs Tariff No.	85366990990

Approvals / Certificates

Country specific Approvals

Logo	Approval	Additional Approval Text	Certificate name
	CCA DEKRA Certification B.V.	EN 61535	71-102984
	CCA DEKRA Certification B.V.	IEC 61535	NL-49482

Ship Approvals

Logo	Approval	Additional Approval Text	Certificate name
	ABS American Bureau of Shipping	Steel Vessel Rules	19-HG1869855-PDA
	DNV GL Det Norske Veritas, Germanischer Lloyd	-	TAE00001Z6
	LR Lloyds Register	EN 61535	08/20047 (E2)

Subject to changes. Please also observe the further product documentation!











WAGO Kontakttechnik GmbH & Co. KG
 Hansastr. 27
 32423 Minden
 Phone: +49571 887-0 | Fax: +49571 887-169
 Email: info.de@wago.com | Web: www.wago.com

Do you have any questions about our products?
 We are always happy to take your call at +49 (571) 887-44222.

UL-Approvals

Logo	Approval	Additional Approval Text	Certificate name
	cURus Underwriters Laboratories Inc.	UL 1977	E45171

Counterpart

	Item no.890-1105 Socket; 5-pole; Cod. I; 1,50 mm²; blue	www.wago.com/890-1105
	Item no.890-2105 Snap-in socket; 5-pole; Cod. I; 1,50 mm²; blue	www.wago.com/890-2105
	Item no.890-2105/006-000 Snap-in socket; without locking lever; 5-pole; Cod. I; 1,50 mm²; blue	www.wago.com/890-2105/006-000
	Item no.890-3105 Socket for PCBs; straight; 5-pole; Cod. I	www.wago.com/890-3105
	Item no.890-617 T-distribution connector; 5-pole; Cod. I; 1 input; 2 outputs; 2 locking levers; blue	www.wago.com/890-617
	Item no.890-3105/011-000 Socket for PCBs; angled; 5-pole; Cod. I	www.wago.com/890-3105/011-000
	Item no.890-620 T-distribution connector; 5-pole; Cod. I; 1 input; 2 outputs; 3 locking levers; for flying leads; blue	www.wago.com/890-620
	Item no.890-982 h-distribution connector; 5-pole; Cod. I; 1 input; 2 outputs; outputs on one side; 2 locking levers; blue	www.wago.com/890-982
	Item no.890-983 h-distribution connector; 5-pole; Cod. I; 1 input; 2 outputs; outputs on one side; 3 locking levers; for flying leads; blue	www.wago.com/890-983
	Item no.891-8985/006-101	

Subject to changes. Please also observe the further product documentation!

pre-assembled interconnecting cable; Eca; Socket/plug; 5-pole; Cod. I; H05VV-F 5G 1.5 mm²; 1 m; 1,50 mm²; blue

www.wago.com/891-8985/006-101

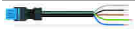

Item no. 891-8985/106-101

pre-assembled connecting cable; Eca; Socket/open-ended; 5-pole; Cod. I; H05VV-F 5G 1.5 mm²; 1 m; 1,50 mm²; blue

www.wago.com/891-8985/106-101

Compatible products

tools

Item no.: 210-719

Operating tool; Blade: 2.5 x 0.4 mm; with a partially insulated shaft

www.wago.com/210-719

Item no.: 890-385

Operating tool; 5-way; green

www.wago.com/890-385

Locking lever

Item no.: 890-101

Locking lever; for manual operation; black

www.wago.com/890-101

Item no.: 890-111

Locking lever; for flying leads; for tool operation; black

www.wago.com/890-111

Item no.: 890-121

Locking lever; for manual operation; white

www.wago.com/890-121



Item no.: 890-131

Locking lever; for flying leads; for tool operation; white

www.wago.com/890-131

Strain relief plate



Item no.: 890-505

Strain relief housing; 5-pole; with locking clip; for 1 cable; 6.5 ... 10.5 mm; 45 mm; black

www.wago.com/890-505

Item no.: 890-515

Strain relief housing; 5-pole; with locking clip; for 1 cable; 6.5 ... 10.5 mm; 45 mm; white

www.wago.com/890-515

assembling



Item no.: 890-310

Mounting carrier; 2- to 5-pole; for flying leads; black

www.wago.com/890-310



Item no.: 890-311

Mounting carrier; 2- to 5-pole; for flying leads; white

www.wago.com/890-311

shield connection



Item no.: 890-527

Shield connecting plate; 5-pole; for plugs

www.wago.com/890-527

Subject to changes. Please also observe the further product documentation!

WAGO Kontakttechnik GmbH & Co. KG

Hansastr. 27

32423 Minden

Phone: +49571 887-0 | Fax: +49571 887-169

Email: info.de@wago.com | Web: www.wago.com

Do you have any questions about our products?

We are always happy to take your call at +49 (571) 887-44222.

Downloads

CAD/CAE-Data

CAD data

2D/3D Models 890-1115

[URL](#)

[Download](#)

CAE data

WSCAD Universe 890-1115

[URL](#)

[Download](#)

Installation Notes

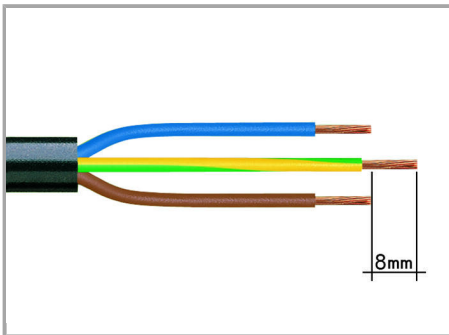

1. Strip length, outer insulation = 30 mm (2-pole), 37 mm (3-pole), 45 mm (4- and 5-pole)

2. Strip length = 9 mm

3. Extended ground conductor = 8 mm

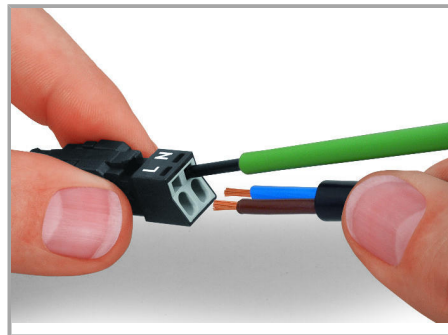

To terminate fine-stranded conductors, open the clamping unit via screwdriver (2.5 mm blade width) and insert a stripped conductor until it hits backstop. Terminate solid conductors by simply pushing them in.

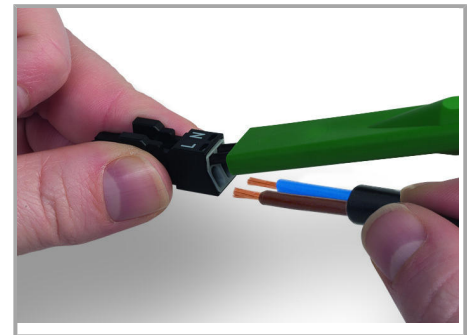

To terminate fine-stranded conductors, open clamping units via operating tool (890-382) and insert stripped conductors until they hit backstop.

Terminate solid conductors by simply pushing them in.

Subject to changes. Please also observe the further product documentation!

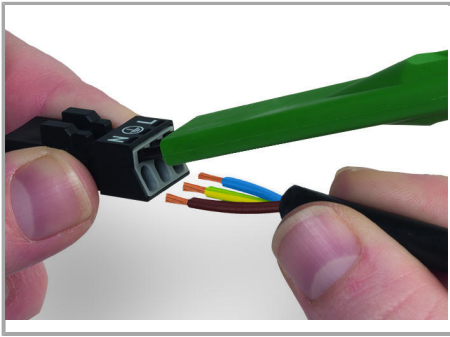

To terminate fine-stranded conductors, open clamping units via operating tool (890-383) and insert stripped conductors until they hit backstop.

Terminate solid conductors by simply pushing them in.

Installation

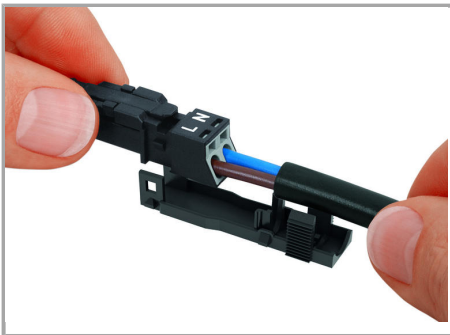

Latch wired connector onto the base of the strain relief housing.

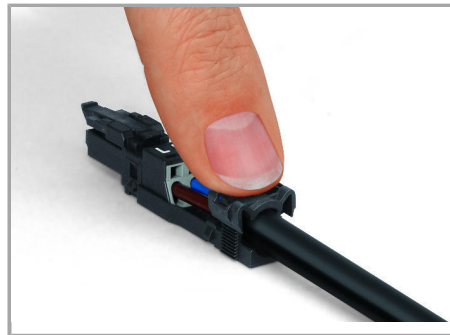

Push down strain relief clamp by hand.



Push down strain relief clamp via 2.5 mm screwdriver alternately on both sides.

Subject to changes. Please also observe the further product documentation!



Latch the top of the strain relief housing.

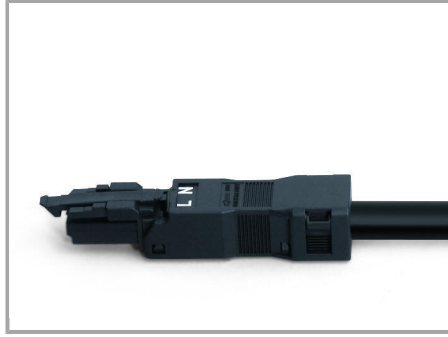

The printed marking of the connector is clearly visible in the openings of the strain relief housing.

Shield Connection

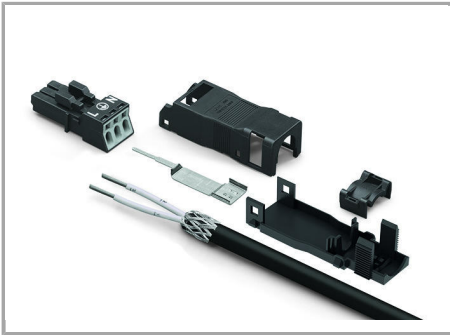

Connector with shield termination

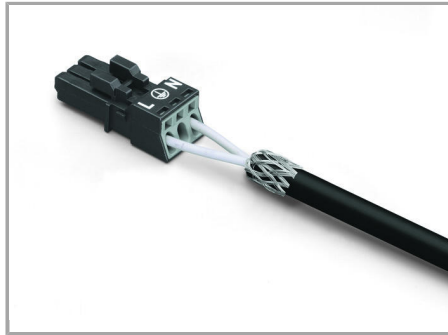

Apply the shield to the rubber cable.

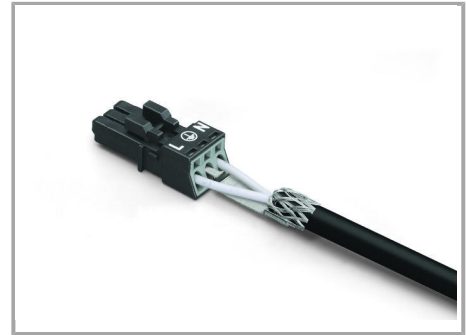

Push the shield connecting plate into the connector until fully inserted.

Strip length, outer insulation = 30 mm

Shield length = 8 mm

Subject to changes. Please also observe the further product documentation!

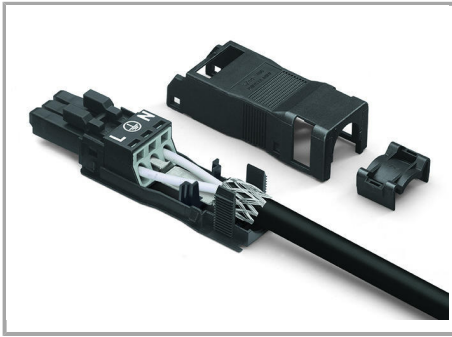

First insert wired connector into strain relief housing, then snap the clamp and cover.

Product family

WINSTA® MINI

[Show all products from the family](#)

Subject to changes. Please also observe the further product documentation!